

# UK Acid Deposition Monitoring Network: Data Summary 2007

Report to the Department for Environment, Food and  
Rural Affairs and the Devolved Administrations

AEAT/ENV/R/2706  
ED48750  
Issue 1  
October 2008



<b>Title</b>	UK Acid Deposition Monitoring Network: Data Summary 2007
<b>Customer</b>	Department for Environment, Food and Rural Affairs (Defra) and the Devolved Administrations – Scottish Government, Welsh Assembly Government and Department of Environment Northern Ireland
<b>Customer reference</b>	RMP 2901
<b>Confidentiality, copyright and reproduction</b>	This report is the Copyright of Defra and has been prepared by AEA Technology plc under contract to Defra dated 20 January 2006. The contents of this report may not be reproduced in whole or in part, nor passed to any organisation or person without the specific prior written permission of Defra. AEA Technology plc accepts no liability whatsoever to any third party for any loss or damage arising from any interpretation or use of the information contained in this report, or reliance on any views expressed therein
<b>Report number</b>	AEAT/ENV/R/2706 Issue 1
<b>File Reference</b>	ED48750

AEA group  
329 Harwell  
Didcot  
Oxfordshire  
OX11 0QJ

t: 0870 190 1900

AEA is a business name of AEA Technology plc

AEA is certificated to ISO9001 and ISO14001

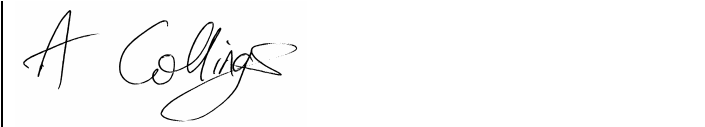
<b>Author</b>	Name	Helen Lawrence, Keith Vincent, Brian Donovan, Martin Davies, Malcolm Smith and Chris Colbeck (AEA)  Y.S. Tang, N. van Dijk, M. Anderson, I. Simmons, R.I. Smith, J.N. Cape, D. Fowler, M.A. Sutton (Centre for Ecology and Hydrology, Edinburgh)
<b>Reviewed by</b>	Name	Brian Donovan, Keith Vincent
<b>Approved by</b>	Name	Dr Alan Collings
	Signature	
	Date	30 October 2008

## Version History

<b>Version</b>	<b>Version Number</b>	<b>Date Available</b>
Initial draft for internal review	AEAT/ENV/R/2706 Draft	28 September 2008
Draft to Defra and the Devolved Administrations	AEAT/ENV/R/2706 Draft for comment	7 October 2008
Issue 1	AEAT/ENV/R/2706 Issue 1	30 October 2008

# Executive Summary

This is the third annual data report prepared under the *UK Acid Deposition Monitoring Network* contract (RMP 2901), let by the Department for Environment, Food and Rural Affairs (Defra) and the Devolved Administrations (the Scottish Government, the Welsh Assembly Government and the Department of Environment Northern Ireland). This data report contains a comprehensive summary of the measurements made in the network for the year 2007.

The Acid Deposition Monitoring Network was established in 1986 to monitor the composition of precipitation and hence to provide information on the deposition of acidifying compounds in the UK. The aims of the rainwater sampling programme are to provide:

- (1) High quality data which can be used to identify trends over time; and
- (2) Information on the spatial distribution of acid deposition in the UK.

In addition to the sampling of rainwater, a range of other measurements are made at the network sites, which provide a more complete understanding of precipitation chemistry in the UK.

A number of important observations have arisen from the data provided by the monitoring network, an example being the geographical differences the monitoring network has shown in the rate of change of sulphur and oxidised and reduced nitrogen deposition. Such changes could not have been entirely nor accurately predicted when the monitoring network was set up in 1986. Sulphur deposition has been reduced most significantly (>70 %) close to the UK's major power stations, predominantly within the Yorkshire, Humber and Nottinghamshire regions. However, the rate of deposition in the south west of England has decreased by approximately 30 %, significantly less than national or European sulphur emissions. Such a non-linearity may be attributed to the influence of shipping emissions, and action on an international level is underway to control emissions from the shipping sector. Likewise, it could not have been predicted that nitrate deposition would show only a marginal decrease in areas far from the major power stations, or that there would be a lack of trend in ammonium deposition.

Following the re-tendering of the monitoring contract in January 2006, significant changes were made to the measurement programme, most notably the expansion of the nitric acid denuder network from 12 to 30 sites. Filter-pack measurements of sulphur dioxide were terminated and effectively replaced by measurements made in the expanded denuder network. A small number of acid deposition sampling sites were re-located, where practical, to achieve greater co-location of sampling within this programme (*i.e.* with the nitric acid denuder measurements) and/or with other national monitoring programmes such as the National Ammonia Monitoring Network. Some diffusion tube monitoring sites not used in the nitrogen dioxide Pollution Climate Mapping work were closed, allowing triplicate tubes to be established at some sites co-located with automatic chemiluminescence analysers.

## **The 2007 Measurements**

The key highlights from the 2007 measurements are:

- Concentrations of the gaseous and aerosol species in 2007 were consistent with long-term trends. There were no major episodes of elevated concentrations.
- Based on measurements from the bulk rainwater collectors, the rainwater volumes in 2007 were similar to the twenty year mean volumes measured at most sites since 1986.
- Particulate sulphate concentrations have shown a downward trend since the late 1980s, although this decrease has been less marked in recent years. The annual mean sulphate concentration at Eskdalemuir was slightly higher than that measured in 2004, 2005 and 2006, although still lower than the concentration observed during the photochemically active year of 2003. Over the period 1978 to 2007, the average sulphate concentration at Eskdalemuir has declined from around 1.0  $\mu\text{g} [\text{SO}_4 \text{ as S}] \text{ m}^{-3}$  to around 0.35  $\mu\text{g} [\text{SO}_4 \text{ as S}] \text{ m}^{-3}$  in 2004, rising slightly to 0.45  $\mu\text{g} [\text{SO}_4 \text{ as S}] \text{ m}^{-3}$  in 2007.

- The 2007 annual mean concentrations of nitrogen dioxide were in line with those measured in 2006. The highest concentrations continue to be observed in the south east of England with an annual mean concentration of 7.0 ppb measured at Flatford Mill in 2007. Nitrogen dioxide concentrations have declined most noticeably at the relatively high concentration sites such as High Muffles, Barcombe Mills, Flatford Mill and previously Stoke Ferry.
- The Nitric Acid Monitoring Network continues to provide data on the behaviour of gaseous and aerosol species involved in transboundary and urban air pollution. The measurement data has been used to derive maps of the spatial distribution of gaseous nitric acid and hydrogen chloride in the UK, and of the corresponding aerosol components, nitrate and chloride.
- The 2007 measurements provide further confirmation of the spatial patterns in trends previously observed.

### **Use of the Measurement Data**

The UK network also forms part of the wider network of the European Monitoring and Evaluation Programme (EMEP). Results from this network are used to underpin the modelling studies that form the basis of negotiation of UNECE Protocols, which control the transboundary transport of acidifying pollutants.

Datasets produced by the Acid Deposition Monitoring Network provide information on the current state of the environment with respect to acidification and eutrophication. The individual measurements are used in a number of projects supported by Defra and the Devolved Administrations:

- **Modelling the Concentrations and Depositions of Long Range Air Pollution** (current contractor: CEH Edinburgh): The measurements made in the Acid Deposition Monitoring Network form the basis to the Concentration Based Estimates of Deposition (CBED) maps produced by CEH Edinburgh. These, and site-specific deposition rates, are used to validate the performance of long range chemical transport models.
- **Pollution Climate Mapping** (current contractor: AEA): The measurements of sulphur dioxide, nitrogen dioxide and particulate sulphate made in the Acid Deposition Monitoring Network provide input to the modelling approaches developed by AEA, to meet the reporting requirements under the first Air Quality Daughter Directive.
- **Freshwater Critical Load Exceedences** (current contractor: ENSIS). A number of the sites in the Acid Deposition Monitoring Network are located in sensitive catchments and freshwater systems. The measurements made in the sampling programme therefore provide a direct measure of the atmospheric input and can be compared with critical loads of such systems.
- **Dynamic Modelling** (current contractor: CEH Bangor): A number of Acid Deposition Monitoring sites are located in sensitive catchments and freshwater systems. The measurements made in the sampling programme therefore provide a direct measure of the atmospheric input, and are used in dynamic models used to assess the impact of acid and nitrogen deposition on freshwater and terrestrial habitats.
- **Acid Waters Monitoring Network** (current contractor: ENSIS): The measurements made in the Acid Deposition Monitoring Network are used in the major periodic assessment reports prepared under this contract.

The measurements made in these networks have been, and continue to be, key inputs into the expert reviews of our understanding of acid deposition, provided formerly by the Review Group on Acid Rain and more recently by the National Expert Group on Transboundary Air Pollution (NEG-TAP). Data from the monitoring network will form the basis to the discussions of trends within the Review of Transboundary Air Pollution (RoTAP), which is due to be published in 2009.

In addition, wet deposition and particulate sulphate measurements have long been key inputs to the Co-operative Programme for Monitoring and Evaluation of the Long-range Transmission of Air Pollutants in Europe (EMEP). Rainfall composition, daily particulate sulphate and gas/particle ratio measurements made within the Acid Deposition Monitoring Network are submitted to EMEP as part of the UK's Acidification and Eutrophication requirements under the new EMEP Monitoring Strategy.

# Table of contents

<b>1</b>	<b>Introduction</b>	<b>1</b>
<b>2</b>	<b>The Monitoring Programme</b>	<b>3</b>
2.1	Acid Deposition Monitoring Network	3
2.2	Sampling Techniques	10
2.3	Analytical Procedures	11
2.4	Data Reporting	12
<b>3</b>	<b>Measurements and Trends – 2007</b>	<b>14</b>
3.1	Rainwater Volumes	14
3.2	Precipitation Chemistry	16
3.3	Particulate Sulphate Measurements	23
3.4	Nitrogen Dioxide Measurements	25
<b>4</b>	<b>Nitric Acid Monitoring Network</b>	<b>29</b>
4.1	Introduction	29
4.2	Method and Data Collection	30
4.3	Measurements	32
4.4	Discussion	40
<b>5</b>	<b>Other Activities</b>	<b>42</b>
5.1	EMEP Intercomparison	42
5.2	LGC Prepared Samples	44
	<b>References</b>	<b>46</b>
	<b>Acknowledgements</b>	<b>48</b>

## Appendices

Appendix 1	Bulk Precipitation Data 2007
Appendix 2	Tables of Mean Concentration and Total Rainfall 1986 – 2007
Appendix 3	Concentration Data for Particulate Sulphate 2007
Appendix 4	Concentration Data for Nitrogen Dioxide 2007
Appendix 5	Nitric Acid Denuder Measurements 2007
Appendix 6	Geostatistics





# 1 Introduction

This is the third annual data report prepared under the *UK Acid Deposition Monitoring Network* contract (RMP 2901), let by the Department for Environment, Food and Rural Affairs (Defra) and the Devolved Administrations (the Scottish Government, the Welsh Assembly Government and the Department of Environment Northern Ireland). This data report contains a comprehensive summary of the measurements made in the network for the year 2007.

The Acid Deposition Monitoring Network was established in 1986 to monitor the composition of precipitation and hence to provide information on the deposition of acidifying compounds in the UK. The aims of the rainwater sampling programme are to provide: (1) high quality data which can be used to identify trends over time, and (2) information on the spatial distribution of acid deposition in the UK. In addition to the sampling of rainwater at the network sites, a range of other measurements are made that provide a more complete understanding of precipitation chemistry in the UK. The measurements made and their interpretation for the calendar years 1986 to 2006 have been presented previously [e.g. Campbell *et al.*, 1994, 1998; Vincent *et al.*, 1995, 1996, 1998; Hayman *et al.*, 2000, 2001c, 2001d, 2003a, 2004, 2005a, 2005b, 2007a; Lawrence *et al.*, 2007].

Measurements made within the networks have provided key inputs into the comprehensive reviews of our understanding of acid deposition. The third and fourth reports of the Review Group on Acid Rain (RGAR) covered the periods from 1986 to 1988 and from 1992 to 1994, respectively [RGAR, 1990; RGAR, 1997]. The results have informed the deliberations of the National Expert Group on Transboundary Air Pollution (NEGTAP), established by Defra in 1999 to advise on transboundary air pollution issues, and specifically whether the reductions in the emissions of acidifying pollutants have been effective in promoting the recovery of ecosystems affected by acid deposition. A report was published in 2001 [NEGTAP, 2001].

Data from the monitoring network will form the basis for the discussions of trends within the Review of Transboundary Air Pollution (RoTAP), which is due to be published in 2009.

Wet deposition and particulate sulphate measurements have long been key inputs to the Co-operative Programme for Monitoring and Evaluation of the Long-range Transmission of Air Pollutants in Europe (EMEP). EMEP is a scientifically based and policy driven programme under the Convention on Long-Range Transboundary Air Pollution (CLRTAP) for international co-operation in solving transboundary air pollution problems. The EMEP programme is carried out in collaboration with a broad network of scientists and national experts that contribute to the systematic collection, analysis and reporting of emissions data, measurement data and integrated assessment results. Initially, EMEP focused on assessing the transboundary transport of acidification and eutrophication, although the scope of the programme has now widened to address the formation of ground level ozone, and, more recently, of persistent organic pollutants (POPs), heavy metals and particulate matter.

The main objectives of EMEP are as follows:

- (a) Provide observational and modelling data on pollutant concentrations, deposition, emissions and transboundary fluxes on the regional scale and identify their trends in time;
- (b) Identify the sources of the pollution concentrations and depositions and to assess the effects of changes in emissions;
- (c) Improve our understanding of chemical and physical processes, relevant to assessing the effects of air pollutants on ecosystems and human health in order to support the development of cost-effective abatement strategies; and
- (d) Explore the environmental concentrations of new chemical substances that might require the attention of the Convention in the future.

This is achieved through (1) collection of emissions data, (2) measurements of air and precipitation quality and (3) modelling of atmospheric transport and deposition of air pollution. The wet deposition, daily particulate sulphate and gas/particle ratio measurements made by the Acid Deposition

Monitoring Network are sent to EMEP, and are key to fulfilling the UK's Acidification and Eutrophication requirements of the new EMEP Monitoring Strategy<sup>1</sup>.

**This Annual Data Report is structured as follows:**

- Section 2 describes the monitoring networks and the sampling techniques employed, together with the changes made to the network in 2007;
- Section 3 gives an overview of the results from the Acid Deposition Monitoring Networks for 2007 and presents concentration maps for non-seasalt sulphate, nitrate, ammonium, hydrogen ion and nitrogen dioxide, together with the trends in all acidifying components measured as part of the monitoring programme;
- Section 4 describes the Nitric Acid Monitoring Network and discusses the measurements made.
- Appendices: Summary tables of the bulk precipitation composition data for 2007 at the individual sites are presented in Appendix 1. Time series graphs for data collected since 1986, and seasonal variation plots are presented together with details of the sites themselves. Appendix 2 presents the annual concentrations measured at each site since 1986, together with the annual rainfall amounts determined using the bulk rain collectors. Individual particulate sulphate measurements are provided in Appendix 3, together with the monthly and annual mean concentrations calculated for each site. Appendix 4 provides a summary of the nitrogen dioxide measurements (both for single tubes and triplicates), together with the annual mean concentrations calculated for each site. Appendix 5 provides a complete set of the measurements made in the Nitric Acid Monitoring Network in 2007, including temporal trends of  $\text{HNO}_3/\text{NO}_3^-$  and  $\text{SO}_2/\text{SO}_4^{2-}$ . Appendix 6 describes the geostatistical techniques that have been used to calculate the concentration maps in this report.

---

<sup>1</sup> EMEP Monitoring Strategy and Measurement Programme 2004-2009, As amended and adopted by the EMEP Steering Body at its twenty-eighth session, [http://www.unece.org/env/emep/Monitoring%20Strategy\\_full.pdf](http://www.unece.org/env/emep/Monitoring%20Strategy_full.pdf)

## 2 The Monitoring Programme

### 2.1 Acid Deposition Monitoring Network

#### 2.1.1 Monitoring Locations

Historically, the UK Acid Deposition Monitoring Network comprised two monitoring networks, in which rainwater samples were collected and analysed. The aim of the first network, known as the ‘Primary’ network, was to provide high quality and high frequency data that could be used to identify trends with time. The “Secondary” network provided information on the spatial distribution of acid deposition in the UK. Originally, there were 9 primary and 59 secondary monitoring sites, although both networks were reduced in size to 5 and 32 sites, respectively, following recommendations from the Review Group on Acid Rain (RGAR) in 1989.

In recent years, the distinction between the primary and secondary networks has become blurred with changes to the monitoring programme. In 2007, the UK Acid Deposition Monitoring Network comprised of 38 sites, 6 of which provide data to EMEP. The spatial distribution of the sites is shown in Figure 2-1.

**Figure 2-1 Locations of the Acid Deposition Monitoring Sites operational in 2007, showing sites that provide measurements to EMEP**



Estimates of sulphur and nitrogen deposition in sensitive areas have been improved by increasing the number of sites in such areas, as recommended in the Fourth Report of the RGAR [RGAR, 1997]. Seven new sites were established in the early part of 1999 to monitor rainwater composition in these ecologically sensitive locations:

- Lochnagar
- Scoat Tarn
- River Etherow
- Llyn Llagi
- Loch Chon / Tinker
- Beaghs Burn
- Crai Reservoir (Head of the Valleys)

The locations are shown below in Figure 2-2.

**Figure 2-2 Rainwater sites in ecologically sensitive locations**



With the exception of Crai Reservoir, all sites were specifically located within sensitive ecosystems forming part of the UK Acid Waters Monitoring Network, which provides measurements of the composition of lakes and freshwaters affected by acid deposition.

The rainwater samples are collected on a fortnightly basis, using bulk deposition collectors as per the existing acid deposition monitoring sites.

## 2.1.2 The Sampling Programme

2007 was the second year of the monitoring contract RMP 2901 which commenced in January 2006. Although the rainwater sampling programme was largely unaffected, a number of significant changes were made to other elements of the UK Acid Deposition Monitoring Network as part of the re-tendering process.

- **Expansion of the Nitric Acid Monitoring Network from 12 to 30 sites.** This sampling programme determines gaseous concentrations of nitric acid (HNO<sub>3</sub>), sulphur dioxide (SO<sub>2</sub>), hydrogen chloride (HCl) and 6 aerosol components (sulphate, nitrate, chloride, sodium, calcium and magnesium) using coated denuders and filters on a monthly basis. The Nitric Acid Monitoring Network was expanded from 12 to 30 sites in January 2006. This network and its expansion is described in detail in Section 4.
- **Termination of the SO<sub>2</sub> filter-pack measurements** in the Acid Deposition Monitoring Network and related Rural SO<sub>2</sub> Monitoring Network (part of the Acid Deposition Processes in the UK). SO<sub>2</sub> concentrations are now determined from the expanded Nitric Acid network.
- **Relocation of Acid Deposition monitoring sites**, where practical, to achieve greater co-location of sampling within this programme (*i.e.*, with the nitric acid denuder measurements) and/or with other national monitoring programmes such as the National Ammonia Monitoring Network.

The following sites were moved to nearby sites at the beginning of 2006 to maintain, as far as possible, (a) the same spatial distribution of sites in the network for mapping purposes and (b) a single data record for trend analysis:

Previous 2005 site	Relocation in 2006	Distance between Sites (km)
Woburn	Rothamsted	28.3
Cow Green Reservoir	Moorhouse	6.6
Glen Dye	Glensaugh*	11.0
Achanarras	Forsinain 2	25.3

In 2007, 3 monitoring sites were relocated: Compton was moved to Harwell to enable co-location with other measurements, and Redesdale and Llyn Brianne were moved to Percy's Cross and Ystradffin respectively, due to land ownership/access restrictions at the previous sites.

Previous 2006 site	Relocation in 2007	Date moved	Distance between Sites (km)
Compton	Harwell*	January 2007	7.1
Redesdale	Percy's Cross	April 2007	5.1
Llyn Brianne	Ystradffin	September 2007	2.8

- **Exposure of triplicate diffusion tubes** at 3 sites where they are (or will be) co-located automatic analysers. Triplicate measurements commenced at Yarnier Wood and Eskdalemuir in 2006. Triplicate exposures at Harwell began in January 2007 resulting from the relocation of the rain collector, and diffusion tube from Compton.

As a result, the following 7 diffusion tube sites not used in the production of UK nitrogen dioxide concentration maps were closed:

- England: Bottesford, Preston Montford, Stoke Ferry, Thorganby, Wardlow Hay Cop, Woburn
- Wales: Llyn Brianne

An analysis of the triplicate measurements from all 3 sites is presented in this data report.

The sampling programme for 2007 is shown below in Table 2-1.

Measurement	Technique	Frequency	Number of sites
Precipitation composition	Bulk collector	Daily	1
	Bulk collector	Fortnightly	38
	Sequential wet-only collector *	Daily	1
Particulate sulphate	AGL Bubbler	Daily	5
Nitrogen dioxide	Single diffusion tube	4-weekly	21
	Triplicate diffusion tubes	4-weekly	3
Nitric Acid and other Acid Gases	DELTA Denuder sampler	Calendar-monthly	30

\* Although measured under this contract, data will be reported and discussed as part of the 'Operation & Management of the EMEP Supersite at Auchencorth Moss' contract held by CEH Edinburgh

### 2.1.3 EMEP Data Reporting

Data obtained through the UK Acid Deposition Monitoring network also form part of the wider EMEP network. Wet deposition, daily particulate sulphate and gas/particle ratio measurements made by selected Acid Deposition Monitoring Network sites (shown in blue in Figure 2-1 and also below in Table 2-2) are sent to EMEP, and are key to fulfilling the UK's Acidification and Eutrophication requirements of the EMEP Monitoring Strategy. Results from EMEP are used to underpin the modelling studies that form the basis of negotiation of UNECE Protocols for controlling the transboundary transport of acidifying pollutants.

Components measured in rainfall are: pH, volume (mm), conductivity, Na<sup>+</sup>, K<sup>+</sup>, Ca<sup>2+</sup>, Mg<sup>2+</sup>, NH<sub>4</sub><sup>+</sup>, Cl<sup>-</sup>, SO<sub>4</sub><sup>2-</sup> and NO<sub>3</sub><sup>-</sup>.

AEA site code	EMEP site code	Site name	Deposition			Particulate SO <sub>4</sub> <sup>2-</sup>
			Daily wet-only	Daily bulk	Multi-day bulk	
5002	GB0002R	Eskdalemuir		✓	✓	✓
5006	GB0006R	Lough Navar			✓	✓
5007	GB0007R	Barcombe Mills				✓
5008	GB0013R	Yarner Wood			✓	✓
5009	GB0014R	High Muffles			✓	✓
5010	GB0015R	Strathvaich Dam			✓	
5341	GB0048R	Auchencorth Moss	✓ *			

\* Data will be submitted under the 'Operation & Management of the EMEP Supersite at Auchencorth Moss' contract, held by CEH Edinburgh.

#### 2.1.4 Daily Wet-Only Measurements

The EMEP Monitoring Strategy proposes 3 levels of measurement complexity, each targeting the EMEP objectives in different ways. The main objective of monitoring at Level 1 sites is to provide long-term basic chemical and physical measurements of the traditional EMEP parameters. Level 2 sites will provide additional parameters essential for process understanding and further chemical speciation of relevant components, and thus represent an essential supplement to Level 1 sites. A Level 1 site extending its programme to include Level 2 activities is often referred to as a "Supersite". Level 3 activities are optional and research-oriented (typically undertaken by research groups) and may also include campaign data.

The UK has identified two monitoring sites (Harwell and Auchencorth Moss) that will eventually operate as EMEP Level 2 Supersites. One of the required Level 1 measurements is the sampling of precipitation composition on a daily basis. Defra has already purchased 2 new sequential wet-only collectors for this purpose; the Auchencorth Moss sampler has been operational since June 2006 and deployment at Harwell is planned for the future.

This Acid Deposition Monitoring Network contract (RMP 2901) includes the operation and management of the wet-only collector at Auchencorth Moss, and analysis of the daily samples. Data obtained from this collector will be reported and discussed in full as part of the Defra contract: '*Operation & Management of the EMEP Supersite at Auchencorth Moss*', held by CEH Edinburgh.

Table 2-3 Network Sites and Measurements Made in 2007							
Site	Measurement	Precipitation			NO <sub>2</sub>	Part. SO <sub>4</sub>	HNO <sub>3</sub> denuder
	Frequency	Daily bulk	Daily wet-only	Fortnightly bulk	4-Weekly	Daily	Monthly
Yarner Wood				✓	✓✓✓	✓	✓
Barcombe Mills				✓	✓✓✓	✓	✓
High Muffles				✓	✓	✓	✓
Lough Navar				✓	✓	✓	✓
Eskdalemuir		✓		✓	✓✓✓	✓	✓
Auchencorth Moss			✓ [1]				✓
Goonhilly				✓	✓		✓
Harwell [2]				✓	✓✓✓		✓
Rothamsted [3]				✓	[4]		✓
Flatford Mill				✓	✓		
Tycanol Wood				✓	✓		
Llyn Brianne / Ystradffin [5]				✓	[4]		
Pumlumon				✓	✓		
Stoke Ferry				✓	[4]		✓
Preston Montford				✓	[4]		
Bottesford				✓	[4]		
Llyn Llydaw				✓	✓		
Wardlow Hay Cop				✓	[4]		
Driby				✓	✓		
Thornganby				✓	[4]		
Bannisdale				✓	✓		
Hillsborough Forest [6]				✓	✓		✓
Moorhouse [7]				✓	✓		✓
Loch Dee				✓	✓		
Redesdale / Percy's Cross [8]				✓	✓		
Whiteadder				✓	✓		
Balquhidder				✓	✓		
Polloch				✓	✓		
Glensaugh [9]				✓	✓		✓
Allt a' Mharcaidh				✓	✓		
Strathvaich Dam				✓	✓		✓
Forsinain 2 [10], [11]				✓	✓		✓
Crai Reservoir				✓			
Llyn Llagi				✓			
River Etherow				✓			
Scoat Tarn				✓			
Beaghs Burn				✓			
Loch Chon				✓			
Lochnagar				✓			
Bush							✓
Sutton Bonington							✓
Cwmystwyth							✓
Rosemaund							✓
Narberth							✓
Shetland							✓
London Cromwell Road							✓
Lagganlia							✓
Rum							✓
Edinburgh St Leonards							✓
Carradale							✓
Detling							✓
Ladybower							✓
Plas Y Brenin							✓
Caenby							✓

✓✓✓ Triplicate measurements made

[1] Data reported as part of the 'Operation & Management of the EMEP Supersite at Auchencorth Moss' contract held by CEH Edinburgh

[2] Compton bulk rain collector and diffusion tube moved to Harwell in January 2007. Single diffusion tube replaced by triplicate tubes

[3] Rothamsted bulk rain collector moved from Woburn in 2006

[4] Diffusion tube site closed in 2006

[5] Ystradffin replaced Llyn Brianne in September 2007

[6] Hillsborough Forest – the co-located Nitric Acid monitoring site is called Hillsborough

[7] Moorhouse bulk rain collector and diffusion tube moved from Cow Green Reservoir in 2006

[8] Percy's Cross replaced Redesdale in April 2007

[9] Glensaugh bulk rain collector and diffusion tube moved from Glen Dye in 2006

[10] Forsinain 2 bulk rain collector and diffusion tube moved from Achanarras in 2006. Also replaces Forsinard diffusion tube.

[11] Forsinain 2 – the co-located Nitric Acid monitoring site is called Halladale



<b>Table 2-4 Network Site Details (those in bold report data to EMEP)</b>				
Site code	Site name	OS Grid Reference	Altitude	Local Site Operating Body
<b>5008</b>	<b>Yarner Wood</b>	<b>SX 786789</b>	<b>119</b>	<b>Natural England</b>
<b>5007</b>	<b>Barcombe Mills</b>	<b>TQ 437149</b>	<b>10</b>	<b>South East Water</b>
<b>5009</b>	<b>High Muffles</b>	<b>SE 776939</b>	<b>267</b>	<b>Forestry Commission</b>
<b>5006</b>	<b>Lough Navar</b>	<b>IH 065545</b>	<b>130</b>	<b>Forestry Service, Northern Ireland</b>
<b>5002</b>	<b>Eskdalemuir</b>	<b>NT 235032</b>	<b>259</b>	<b>Met Office</b>
<b>5010</b>	<b>Strathvaich Dam</b>	<b>NH 347750</b>	<b>270</b>	<b>Clova Environmental Research &amp; Testing Services</b>
<b>5341</b>	<b>Auchencorth Moss</b>	<b>NT221562</b>	<b>190</b>	<b>Centre for Ecology &amp; Hydrology (Edinburgh)</b>
5003	Goonhilly	SW 723214	108	BT
5170	Harwell	SU 474863	120	AEA
5165	Rothamsted	TL 131132	130	Rothamsted Experimental Station
5024	Flatford Mill	TM 077333	5	Field Studies Council
5123	Tycanol Wood	SN 093364	205	Countryside Council for Wales (CCW)
5169	Ystradffin	SN 788471	230	Environment Agency Wales
5124	Llyn Brianne	SN 807492	372	Forestry Commission
5150	Pumlumon	SN 823854	390	Centre for Ecology & Hydrology (Bangor)
5004	Stoke Ferry	TL 700988	15	Borough Council of King's Lynn & West Norfolk
5023	Preston Montford	SJ 432143	70	Field Studies Council
5121	Bottesford	SK 797376	32	E.On
5153	Llyn Llydaw	SH 638549	490	Countryside Council for Wales (CCW)
5120	Wardlow Hay Cop	SK 177739	350	Natural England
5136	Driby	TF 386744	47	Anglian Water
5117	Thornaby	SE 676428	8	Selby District Council
5111	Bannisdale	NY 515043	265	Ray Newport
5149	Hillsborough Forest	IJ 243577	120	Agri-Food and Biosciences Institute
5167	Moorhouse	NY 758328	570	Centre for Ecology & Hydrology (Lancaster)
5107	Loch Dee	NX 468779	230	SEPA / Forest Enterprise
5109	Redesdale	NY 833954	240	ADAS
5168	Percy's Cross	NY 880935	170	Allan Murray
5106	Whiteadder	NT 664633	250	East of Scotland Water
5152	Balquhiddy 2	NN 545207	130	Mountain Environments
5151	Polloch	NM 792689	30	Jim Kirby
5164	Glensaugh	NO 660796	242	Macaulay Land Use Research Institute
5103	Allt a' Mharcaidh	NH 876052	274	Fisheries Research Services
5166	Forsinain 2 / Halladale	NC 906486	70	Fountain Forestry Ltd
5154	Crai Reservoir	SN 288222	310	Welsh Water
5160	Llyn Llaji	SH 647483	380	ENSIS
5158	River Etherow	SK 125986	485	ENSIS
5159	Scoat Tarn	NY 158103	595	ENSIS
5155	Beaghs Burn	ID 165283	250	Agri-Food and Biosciences Institute
5156	Loch Chon	NN 429084	150	Fisheries Research Services
5157	Lochnagar	NO 252859	785	ENSIS
1	Bush	NT 245635		Centre for Ecology & Hydrology (Edinburgh)
40	Sutton Bonington	SK 505268		University of Nottingham
70	Cwmystwyth	SN 771742		ADAS
6B	Rosemaund	SO 564476		ADAS
8C	Narberth	SN 146127		Pembrokeshire County Council
19	Shetland	HU 500400		Met Office (Lerwick Observatory)
36C	London Cromwell Road	TQ 266791		CG Images
41	Lagganlia	NH 856037		Centre for Ecology & Hydrology (Banchory)
47	Rum	NM 408992		Scottish Natural Heritage
60C	Edinburgh St Leonards	NT 262731		City of Edinburgh Council
77	Carradale	NR 798378		SEPA
97	Detling	TQ 801597		Medway Council Environmental Health
99	Ladybower	SK 164892		Nick Hewitt
100	Plas Y Brenin	SH 716578		Countryside Council for Wales (CCW)
102	Caenby	SK 993900		West Lindsey District Council

## 2.2 Sampling Techniques

### 2.2.1 Precipitation Composition

#### Bulk Sampling

Fortnightly precipitation samples are collected at 38 sites using bulk collectors based on the design of Hall [1986]. Daily precipitation composition measurements are also made at Eskdalemuir, also a bulk collector. Stone and Tily [1992] have provided an assessment of the collection efficiency of the bulk collector. For the two-year period 1986 to 1987, the bulk collector was found to have collection efficiencies ranging from 77% to 99% when compared to the 5-inch meteorological rain gauge.

To assess whether the switch from single week to fortnightly sampling in 2001 had any effect on sampling performance, an intercomparison exercise was initiated, which continued until the end of 2005. The results of the intercomparison were presented in the 2004 data report (using available results from the start of sampling to the end of 2004) [Hayman *et al.*, 2005b]. The results from the first three years of the intercomparison indicated that there was good agreement between the parameters collected for the different sampling durations. The least scatter about the 1:1 line was seen for rainwater volumes and the deposition of non-seasalt sulphate and nitrate observed at Thorganby, followed by those at Eskdalemuir and Lough Navar.

Local Site Operators (LSOs) collect the samples from the rain collectors, and return them in their entirety to AEA at Harwell for registration, volume measurement and sub-sampling. Sub-samples are then sent to Harwell Scientifics for analysis.

#### Wet-only Sampling

The wet-only sequential sampler can hold 8 daily samples, and sample changeovers are made on a weekly basis. The individual daily samples are returned to AEA at Harwell for registration before being passed to Harwell Scientifics for analysis. The procedures and protocols for sample handling and analysis are the same as those used for determining the composition of precipitation from the bulk sampling programme.

The daily wet-only data will be reported and discussed by CEH Edinburgh as part of the Defra contract: '*Operation & Management of the EMEP Supersite at Auchencorth Moss*'. Data will also be made available to the Air Quality Archive and reported to the Chemical Co-ordination Centre of EMEP, therefore fulfilling the UK's obligations under the Convention on Long-range Transport of Air Pollution.

### 2.2.2 Particulate Sulphate

Concentrations of particulate sulphate are determined on a daily basis using an 8-port hydrogen peroxide bubbler instrument (AGL, Hitchin). Particulate sulphate is collected by drawing air through a Whatman 40 filter at a rate of 2-4 m<sup>3</sup> per day. Each filter is exposed for 24-hours and returned to AEA in an individually sealed plastic bag. Filters are registered by AEA before being passed to Harwell Scientifics for analysis. Concentrations in air are calculated from sulphate concentrations in filter extract solutions (analysed by ion chromatography) and volumes of air sampled in the corresponding 24-hour period.

### 2.2.3 Nitrogen Dioxide

Nitrogen dioxide concentrations are measured using passive diffusion tubes. Diffusion tubes work on the principle that the gas species of interest diffuses up the tube and is collected on an efficient absorbent medium at the end. The amount of gas absorbed is then measured by an appropriate analytical technique. The tube components are manufactured to a 0.1 mm tolerance, providing a known diffusion path length and hence a constant resistance to uptake. The ambient concentration of the gas can then be calculated from the diffusion path length, amount absorbed (determined analytically), exposure time and diffusion coefficient of the gas.

The diffusion tube consists of a plastic tube, on one end of which is a Low Density Polyethylene cap. Two stainless steel grids impregnated with the absorbent chemical are mounted within this cap. In this case, the absorbent is a solution of triethanolamine and acetone. The absorbent is extracted from the exposed tubes using de-ionised water. The nitrite content is analysed using a colorimetric technique on a Bran & Luebbe Segmented Flow Auto Analyser III. The instrument is calibrated at the beginning of each run, and a QC sample of known concentration is analysed several times during any one run in adherence to UKAS guidelines. This particular method has a limit of detection of 0.03 µg nitrite, with any samples greater than 2.0 µg requiring dilution. The exposure time of each diffusion tube is used to convert the measured nitrate amount (in µg) into ambient air concentrations of nitrogen dioxide (in µg NO<sub>2</sub> m<sup>-3</sup> or ppb).

Diffusion tubes are mounted on the upright post of the rain collector stand, 1 metre above the ground, and are exposed for 4-week periods throughout the year to coordinate sample changeovers with the fortnightly rain collections. They are returned to AEA in individual sealed plastic bags for registration before being passed to Harwell Scientifics for analysis.

Laboratory blanks and a 'travel' blank are undertaken for each 4-week monitoring period as QA/QC.

### **Triplicate Diffusion Tubes**

Historically, UK maps of nitrogen dioxide (and hence oxides of nitrogen) used the diffusion tube measurements to define the rural concentration field, upon which urban contributions were superimposed. With the introduction of automatic analysers, mainly in England, a hybrid approach is now adopted in the mapping work [Kent *et al.*, 2006]. Automatic sites, where available, have been used in preference to diffusion tubes, as they are considered to be more accurate. Automatic measurements are preferred at Yarner Wood, High Muffles and Barcombe Mills (automatic site nearby at Lullington Heath). The first year for which sufficient automatic sites are available for this to be possible was 2004. These measures have been established as a result of Directive 2002/3/EC relating to ozone in ambient air. Diffusion tube sampling has therefore stopped at some sites where diffusion tube measurements are not used in the production of the nitrogen dioxide map, allowing the network to be reconfigured to allow triplicate measurements to be made at 3 sites where there are co-located automatic analysers – Yarner Wood, Harwell and Eskdalemuir.

All other aspects of the sampling programme – sampling schedule, analysis, data reporting and dissemination – are the same as described above for the single tubes.

## **2.2.4 Nitric Acid DELTA Denuder**

The DELTA denuder methodology used to determine concentrations of nitric acid, and other acid gases and particulate components is described later in Section 4.

## **2.3 Analytical Procedures**

### **2.3.1 Sample Registration and Preparation**

Due to the termination of the SO<sub>2</sub> filter-pack monitoring element of the programme at the end of 2005, the number of samples received and analysed in 2006 and 2007 was less than in previous years. Sample preparation and handling is carried out using documented operating procedures.

Upon receipt, samples are immediately logged in AEA's sample registration database. Precipitation samples are accurately weighed to determine the volume of the rainwater sample. Samples are then sub-sampled into polyethylene bottles and refrigerated until being transferred to Harwell Scientifics for analysis. Once received by Harwell Scientifics, the rainwater samples are further sub-sampled into Nalgene bottles. The pH and conductivity is measured and the samples then filtered through 1 µm disposable filters to remove insoluble particulate material and microorganisms that may compromise sample integrity before analysis. The samples are then stored at 4 °C until analysis by ion chromatography. Samples are analysed for sulphate, nitrate, chloride, phosphate, sodium, magnesium, calcium, potassium, pH and conductivity. Analysis is usually completed within one month, unless reanalysis is required (see Section 2.3.2).

### 2.3.2 Analysis

Samples are analysed using UKAS-accredited methods. All samples with exception of diffusion tubes are analysed using ion chromatography.

The rapid analysis of a large number of rainwater samples in which concentrations vary over several orders of magnitude is a complex task. To verify the analytical results, the ion balance, *I* (Equation 1), is calculated for each rainwater sample:

$$I = \frac{2(\sum c - \sum a)}{\sum c + \sum a} \tag{Equation 1}$$

where  $\sum c$  = sum of cation concentrations in microequivalents per litre ( $\mu\text{eq l}^{-1}$ ) and  $\sum a$  = sum of anion concentrations in microequivalents per litre ( $\mu\text{eq l}^{-1}$ ). A correction is estimated for the concentration of bicarbonate in samples which have a pH greater than 5.5. Samples that fall outside the criteria listed in Table 2-5 are submitted for reanalysis. The reanalysis is usually completed within four months of sampling. With the introduction of new ion chromatographs [Hayman *et al.*, 2001d], less than 10% of the samples are expected to fail the criteria and would need to be reanalysed.

Table 2-5 Ion Balance Criteria Used to Select Samples for Reanalysis	
Ionic strength concentration range ( $\mu\text{eq l}^{-1}$ )	Samples are resubmitted when the % ion difference is:
Less than 50	> 60 %
50-100	> 30 %
Greater than 100	> 15 %

## 2.4 Data Reporting

Sample collection, analysis, re-analysis and verification are continuous processes. Figure 2-3 below shows the reporting cycle for measurements made in the monitoring programme. Reanalysis is only undertaken for composition of precipitation if the sample fails the ion balance criterion. Simple data verification is undertaken on an approximately quarterly basis for the other measurements.

Figure 2-3 Cycle for the sample collection, analysis, reanalysis, verification and reporting of the Acid Deposition measurements, for the year *N*

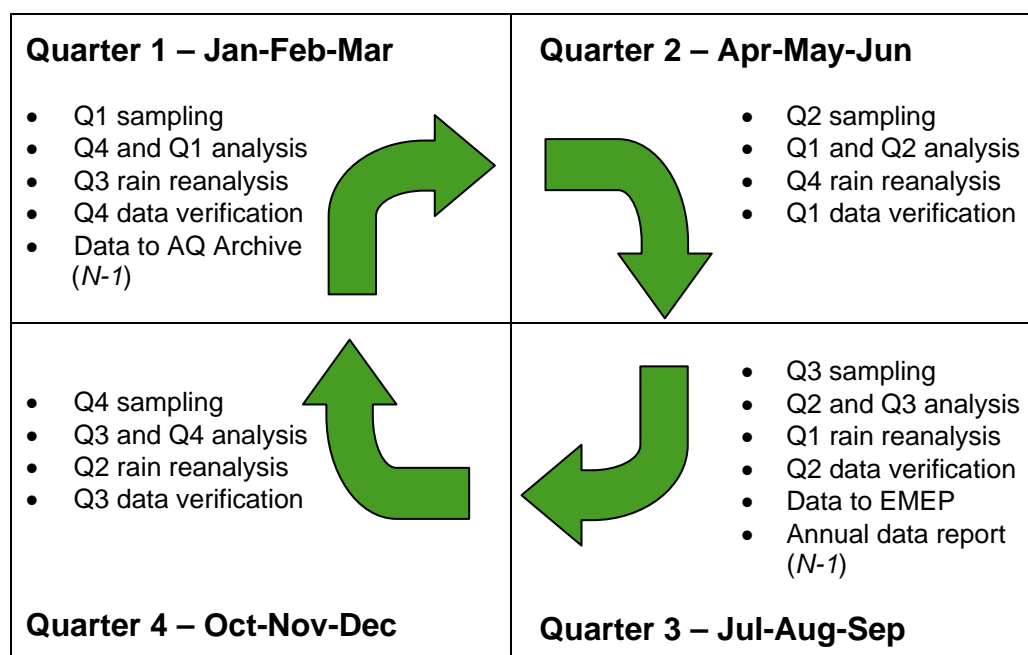

The cycle shows that measurements made in Year *N* would be available to the public and scientific community *via* the Defra-funded UK Air Quality Archive<sup>2</sup> by the end of Quarter 1 of Year *N+1* and formally reported in Quarter 3. The data dissemination target has been met in recent years for sulphate and nitrogen dioxide data, although due to the additional time required for rainwater reanalysis, it remains a challenging target for rain chemistry data dissemination. Progress is being made towards adhering to the annual data report target closely.

Precipitation and particulate sulphate measurements made in the main Acid Deposition Monitoring Network, is reported annually to EMEP's Chemical Co-ordination Centre (EMEP CCC) at NILU, Norway, as part of the UK's obligation under the UNECE Convention on Long-Range Transport of Air Pollution. The UK has a strong commitment to the timely submission of data to this forum.

Measurements of nitrogen dioxide and particulate sulphate are also indirectly reported to the European Commission through other air quality monitoring and modelling contracts.

---

<sup>2</sup> UK National Air Quality Archive: [www.airquality.co.uk](http://www.airquality.co.uk)

### 3 Measurements and Trends – 2007

The complete set of precipitation measurements made in the Acid Deposition Monitoring Network during 2007 is provided in the following appendices:

- Appendix 1 Precipitation Composition from Fortnightly Bulk Collectors
- Appendix 2 Annual Mean Precipitation-weighted Concentrations
- Appendix 3 Particulate Sulphate Measurements and Statistics
- Appendix 4 Nitrogen Dioxide Measurements and Statistics
- Appendix 5 Nitric Acid Denuder Measurements and Statistics

Information about the sites and the measurements made is also provided in Appendix 1. Appendix 6 describes the geostatistical techniques that have been used to calculate the precipitation concentration maps in this report.

#### 3.1 Rainwater Volumes

The 2007 rainwater volumes, measured using the bulk rainwater collectors, were similar at most sites compared to the long-term average measured by the bulk collectors (1986 to 2007), although slightly wetter for the lower rainfall sites. Figure 3-1 shows how the measured rainwater volumes in 2007 compared against the long-term average volume measured in previous years.

**Figure 3-1 A Comparison of Rainwater Volumes in 2007 against the Long-term Mean Determined using the Bulk Rain Collectors**

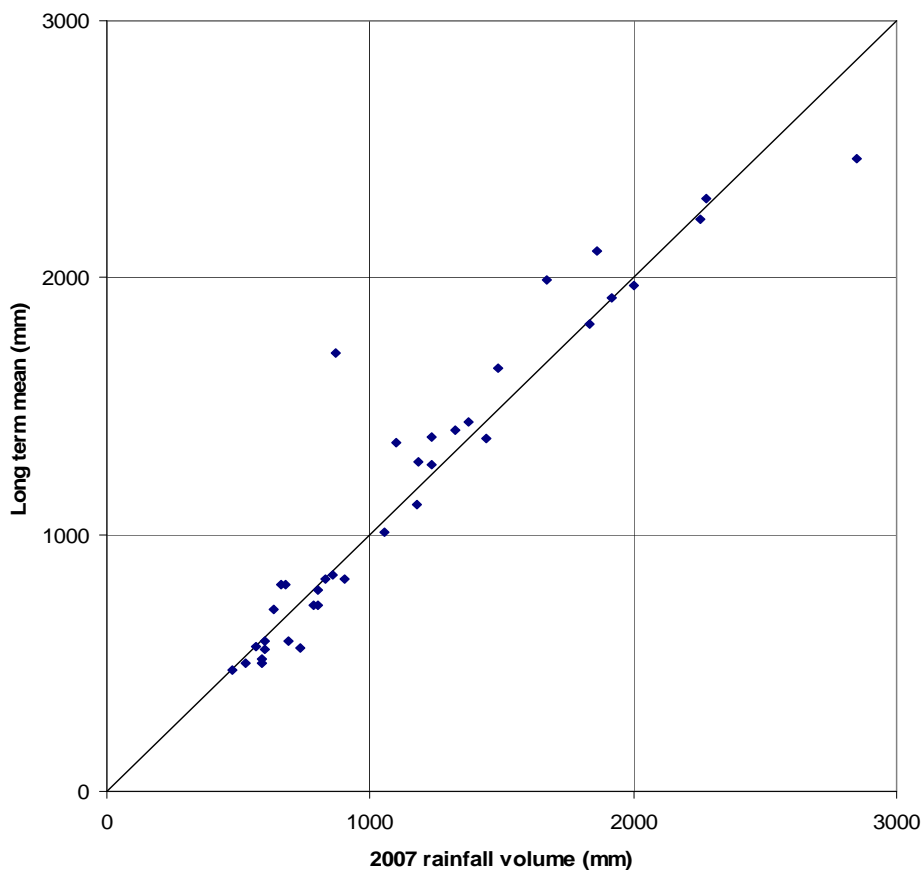

An alternative assessment of the rainfall in 2007 can be based on information provided by the Met Office<sup>3</sup>. The Met Office provides regional, annual average rainfall statistics determined by quality-controlled data from the UK climate network of observing stations. Figure 3-2 shows the average rainfall amounts in England, Wales, Northern Ireland and Scotland during 2007 and how this compares with the long-term (1961-1990) average (showing the 2007 average rainfall as a percentage of the long-term average).

**Figure 3-2 Comparison of regional-average rainwater volumes during 2007 (using Met Office data) and the corresponding difference between 2007 and the long-term average (1961 to 1990)**

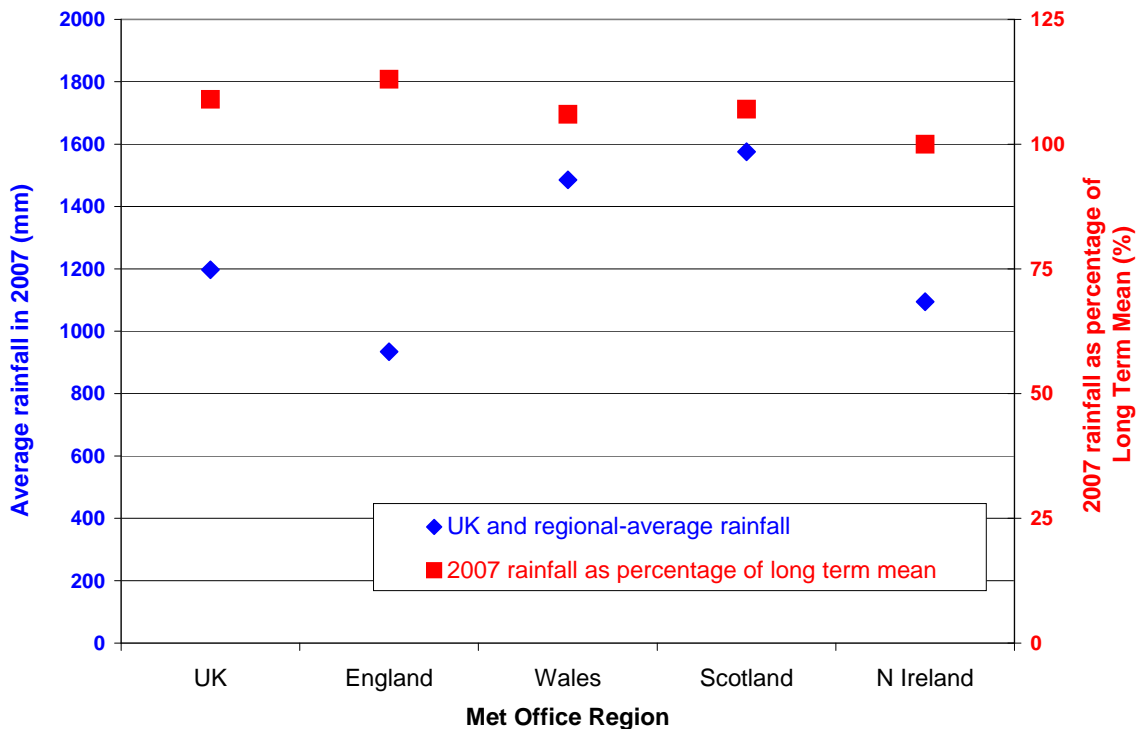

The Met Office confirms that the UK as a whole experienced 9% more rain in 2007 than the 1961-1990 annual average. On average, Scotland was again the wettest region of the UK in 2007, followed by Wales, Northern Ireland and England.

All UK regions experienced more rainfall in 2007 than the long-term average, with the exception of Northern Ireland, which experienced a similar amount to the long-term average amount. Average rainfall in England was 934 mm – much wetter than in previous years (13% more than the long-term annual average). The Met Office records show Wales as receiving 6% more rain in 2007 when compared to the long-term annual average. Scotland saw less rainfall than the previous year, but still 7% more than the long-term annual average.

<sup>3</sup> <http://www.metoffice.gov.uk/climate/uk/2007/annual/averages1.html>

## 3.2 Precipitation Chemistry

### 3.2.1 The Measurements

The measurements of precipitation composition made using the bulk collectors are presented in Appendix 1. It should be noted that the tables in Appendix 1 contain all the analytical results obtained, including those samples affected by contamination by bird strike. A phosphate concentration  $> 0.1 \text{ mg P l}^{-1}$  (or  $> 1.0 \text{ } \mu\text{eq l}^{-1}$ ) was taken as evidence of contamination. Although all these samples have been included in the tables, they were not included in the calculation of annual mean precipitation-weighted ion concentrations<sup>4</sup>. The mean annual rainfall and the precipitation-weighted mean annual concentrations of all ions for the period from 1986 to 2007 are also tabulated in Appendix 2. The rainfall totals presented in Appendix 2, Table 10 include all samples collected, and are therefore higher at times than the totals used for the calculation of the annual mean concentrations.

Appendix 1 also contains 2 plots, which show (a) the trend in the annual precipitation-weighted mean concentrations for non-seasalt sulphate, nitrate, ammonium and hydrogen ion since the commencement of the site, and (b) the trend in the annual rainfall and in the corresponding annual deposition of the four species. The trends shown in the 2 plots varies from site to site (Appendix 1), although in general non-seasalt sulphate and hydrogen ion concentrations have tended to decline whereas nitrate and ammonium show very little change. A box has been included in Appendix 1, which contains a statistical summary of the trends of the 4 ions shown in the plots.

#### Seasonal Variation

Appendix 1 has previously included a figure for each site showing the seasonal variation in the concentrations. The seasonal plots presented in Hayman *et al.* [2000, 2001c,d] clearly showed that the largest concentrations of both non-seasalt sulphate and nitrate occur in the period from April to June at most of the sites. This is partly a consequence of the seasonal variation of emissions and of the oxidising capacity of the atmosphere, as demonstrated by the seasonal variation observed in particulate sulphate concentrations (Figure 3-3, right).

Figure 3-3 Seasonal variation in particulate sulphate concentrations at four of the five sites as averages for 1986-2007

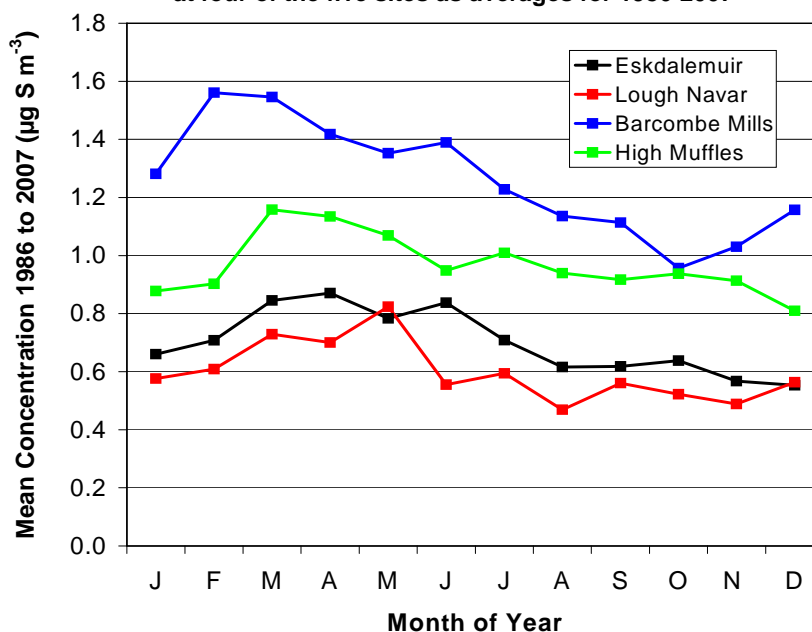

### 3.2.2 Concentration Maps for 2007

The spatial patterns of the annual mean precipitation-weighted concentration of acidity, non-seasalt sulphate, nitrate and ammonium are presented in Figure 3-4 to Figure 3-7, for the 8 most recent years. The parameters used in the interpolation are presented in Appendix 6. As previously reported, there are no hydrogen ion maps for 2000 as the acidity measurements were removed from the 2000 dataset [Hayman *et al.*, 2001d].

<sup>4</sup> Ion concentrations are conventionally reported as precipitation-weighted annual mean concentrations as rainfall is episodic and a few rainfall events can dominate the annual deposition. The wet deposition is then the precipitation-weighted annual mean concentration multiplied by the annual rainfall.



The maps show the following:

- The hydrogen ion concentration tends to be the highest on the eastern seaboard where the rainwater volume is the smallest. Concentrations appear relatively constant over the previous three years.
- The highest concentrations continue to be measured in the source region.
- The nitrate concentrations are remarkably consistent throughout the eight years shown. The trend, or lack of trend, in nitrate concentrations is discussed in the next section.
- Ammonium concentrations are the highest in the areas of the United Kingdom where intensive livestock activity is the highest.

### 3.2.3 Precipitation Chemistry Trends

Analysis of the data has been undertaken to quantify the significance of the trends. The concentration data have been analysed using a linear-least squares approach. The regression coefficient, or slope of the trend line, will have units of  $\mu\text{eq l}^{-1} \text{ year}^{-1}$ . Associated with the regression analysis is a parameter called the F statistic. The F statistic is a measure of how successfully the linear regression can account for the variation in the dataset. It is formally defined as the ratio of the variance due to regression, standardised by the respective degrees of freedom ( $MS_R$ ), to the variance about the regression also standardised by the respective degrees of freedom ( $MS_E$ ). The value of the F statistic can be compared to points on an appropriate F distribution curve. If the value is greater than a certain (critical F) value, it is assumed that a real, statistically significant change in the concentration has occurred.

In the analysis presented below, a 5% significance level has been used. This means that there is a 5% chance that the trend is not significant. Furthermore, the “strength” of the observed trend is quantified using multiples of the ratio of the calculated F statistic to the critical F value. These multiples (more or less arbitrarily defined) are presented in Table 3-1.

Table 3-2 presents a summary of the trend analysis performed on the non-sea salt sulphate and nitrate concentrations measured at the sampling sites in the acid rain monitoring network. Sites that show a very strong trend are situated in relatively dry locations, often downwind of major sources. Values of “ $F_{\text{calculated}} / F_{\text{critical}}$ ” that are  $<1$  indicate that no statistically significant trend can be detected. This most often occurs for sites located in the more remote parts of the United Kingdom.

Figure 3-4 Precipitation-weighted concentration maps of Acidity (in  $\mu\text{eq l}^{-1}$ ) for 2000-2007

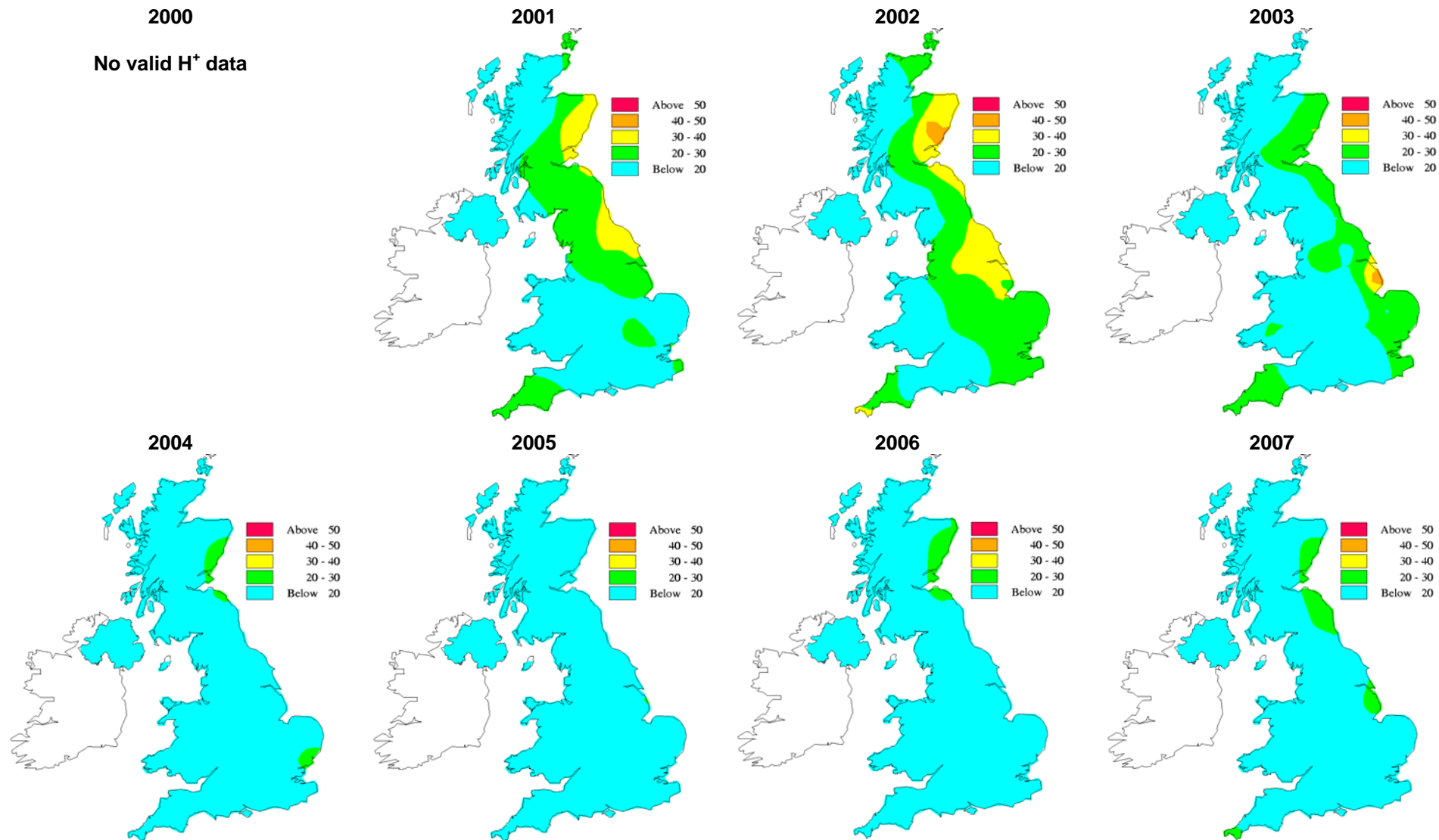

Figure 3-5 Precipitation-weighted Concentration Maps of Non-Seasalt (marine) Sulphate (in  $\mu\text{eq l}^{-1}$ ) for 2000-2007

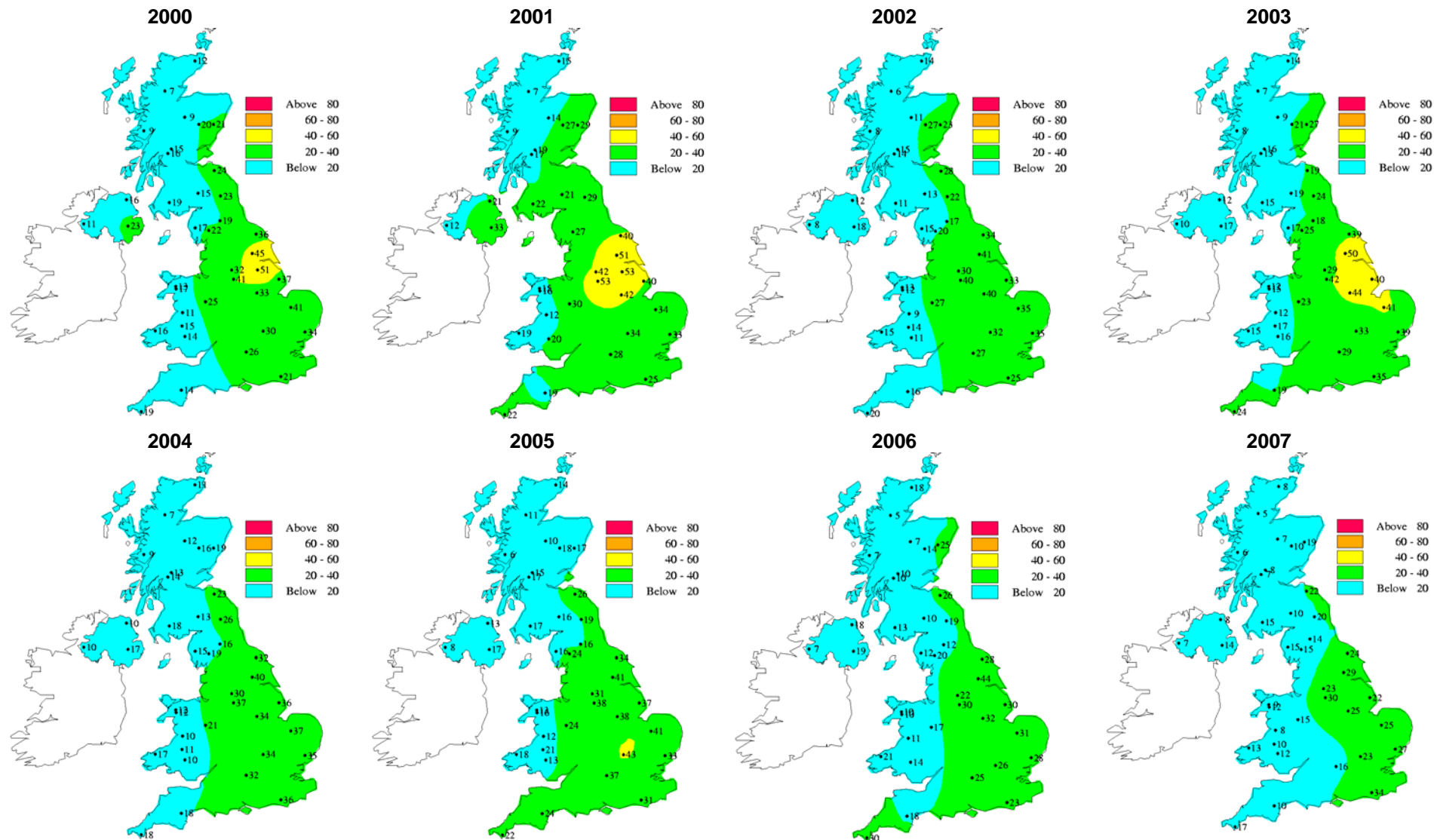

Figure 3-6 Precipitation-weighted Concentration Maps of Nitrate (in  $\mu\text{eq l}^{-1}$ ) for 2000-2007

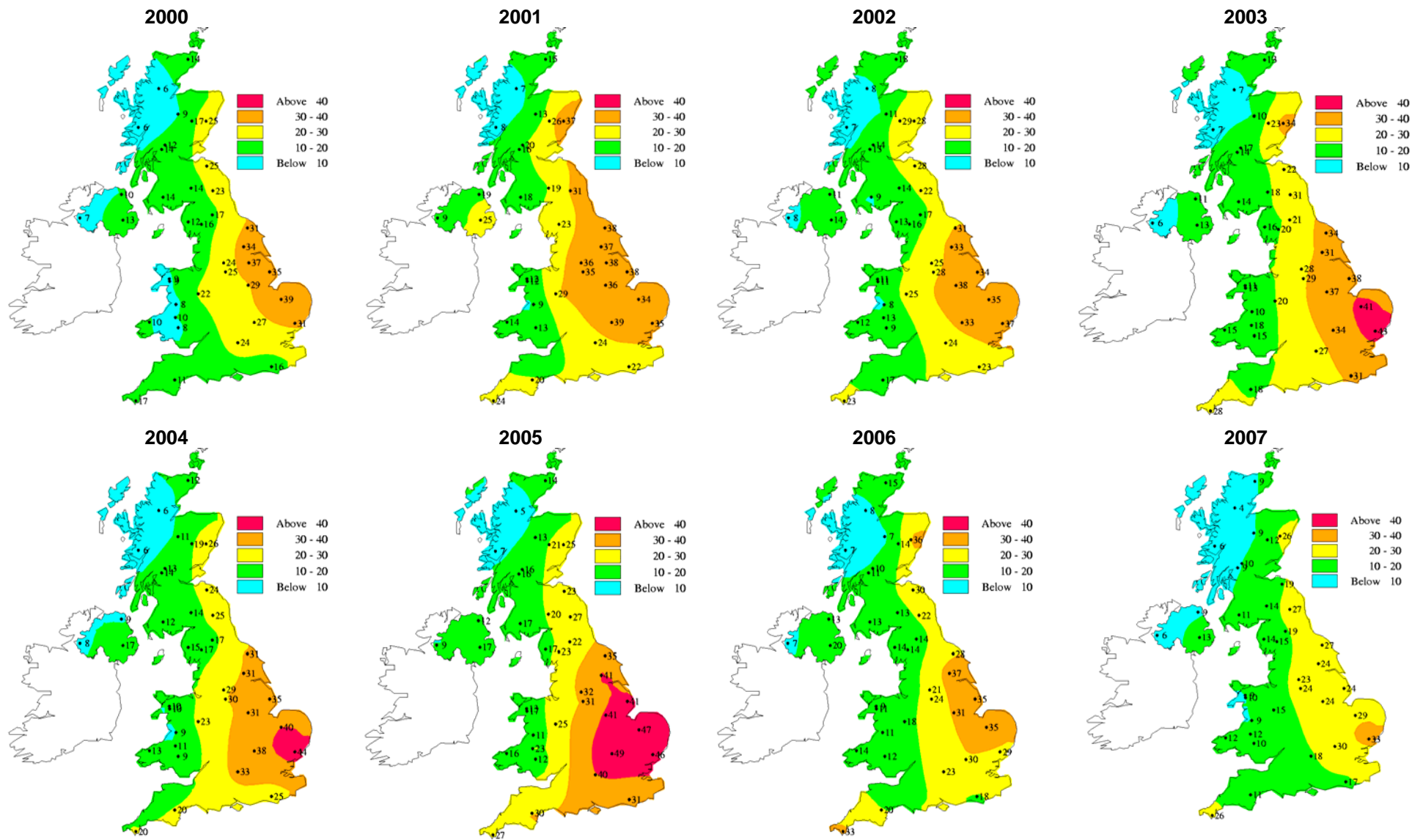
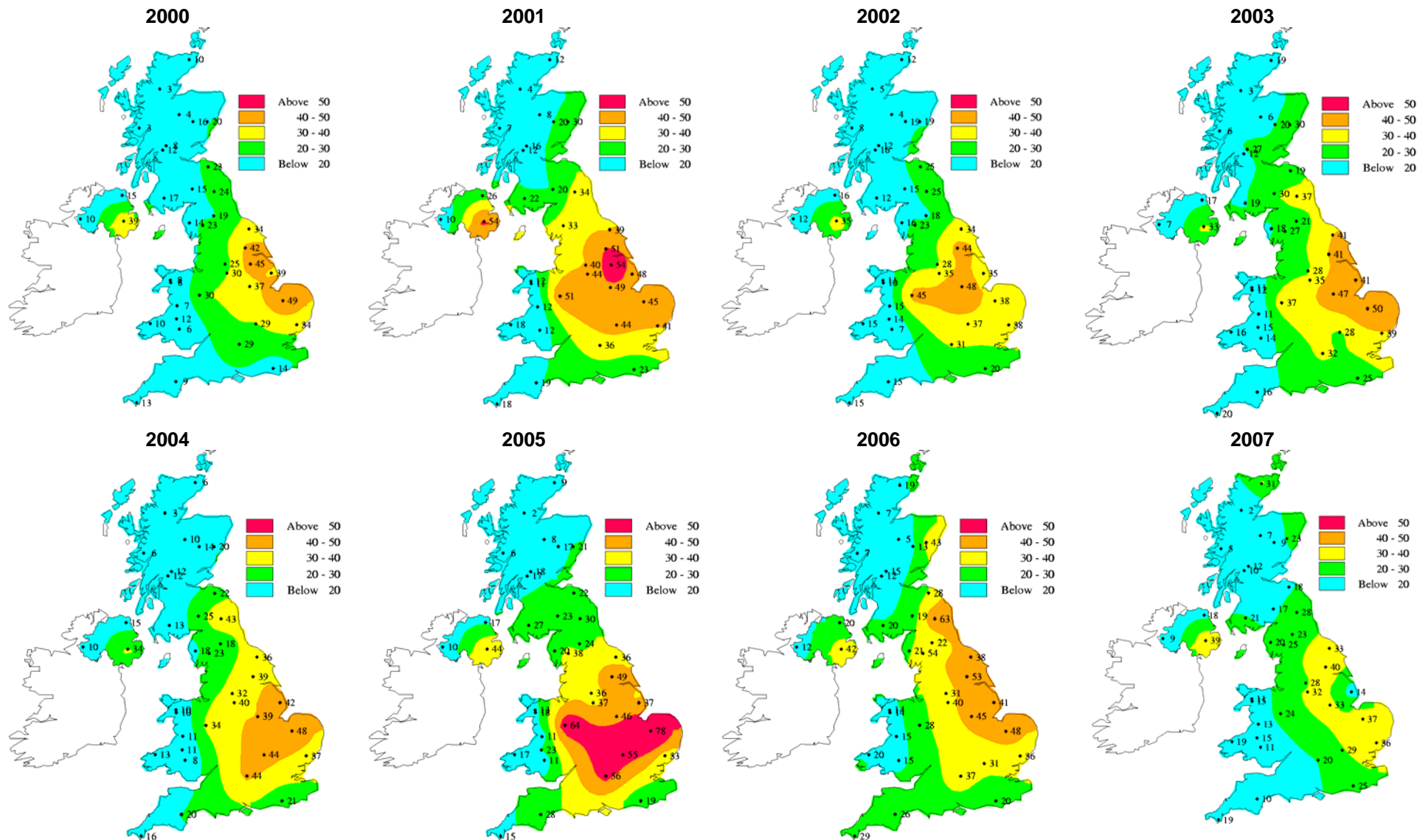

Figure 3-7 Precipitation-weighted Concentration Maps of Ammonium (in  $\mu\text{eq l}^{-1}$ ) for 2000-2007



**Table 3-1 Strength of the Significance of the Trend**

Ratio	Value of ratio	Symbol	Comment
F calculated / F critical	ratio < 1	–	No significant trend
	1 < ratio < 2	+	Significant trend detected
	2 < ratio < 5	++	Moderate trend detected
	5 < ratio < 10	+++	Strong trend detected
	10 < ratio < 20	++++	Very strong trend detected
	ratio > 20	+++++	Exceptionally strong trend detected

**Table 3-2 Summary of the Trend Analysis for nss-Sulphate and Nitrate Observed at the Acid Deposition Monitoring Network Sites and its Significance**

Sampling site	Site Code	Sulphate			Nitrate		
		µeq l year <sup>-1</sup>	% change per year	Trend Status	µeq l year <sup>-1</sup>	% change per year	Trend Status
Achanarras	5140	-0.95	-3.23	++++	-0.43	-1.96	++
Balquhidder	5152	-0.89	-2.96	+++	-0.12	-0.75	–
Bannisdale	5111	-1.33	-2.89	++++	-0.14	-0.65	–
Barcombe Mills	5007	-0.96	-2.14	++	-0.31	-1.10	–
Beaghs Burn	5155	-2.14	-4.07	+	-0.14	-0.97	–
Llyn Llydaw	5153	-1.17	-3.69	+++	-0.20	-1.42	+
Bottesford	5121	-3.24	-3.60	+++++	-0.47	-1.13	++
Compton	5129	-2.87	-3.71	++++	-0.60	-1.58	++
Cow Green Res.	5113	-1.41	-3.34	++++	-0.18	-0.80	–
Crai Res	5154	-0.70	-2.69	–	0.35	6.76	–
Driby	5136	-2.62	-3.26	+++++	-0.57	-1.20	++
Eskdalemuir	5002	-1.08	-3.14	+++++	-0.13	-0.69	–
Flatford Mill	5024	-2.44	-3.27	+++++	-0.38	-0.88	–
Glen Dye	5011	-1.66	-3.19	+++	-0.25	-0.75	–
Goonhilly	5003	-0.47	-1.59	+	0.33	1.62	–
High Muffles	5009	-2.52	-3.22	+++++	-0.68	-1.54	+++
Hillsborough Forest	5149	-1.86	-3.54	++++	-0.26	-1.15	–
Jenny Hurn	5118	-4.13	-3.77	++++	-0.54	-1.15	+
Llyn Brianne	5124	-0.82	-2.76	+++	0.08	0.54	–
Llyn Llagi	5160	-0.67	-2.62	+	0.06	0.58	–
Loch Chon	5156	-0.87	-3.03	+	-0.58	-2.40	+
Loch Dee	5107	-0.95	-2.87	+++	-0.16	-0.96	–
Loch Nagar	5157	-1.68	-3.49	++	-0.74	-2.27	–
Lough Navar	5006	-0.53	-2.80	++++	-0.07	-0.79	–
Polloch	5151	-0.73	-3.57	++++	-0.19	-1.86	+
Preston Montford	5023	-2.21	-3.55	++++	-0.48	-1.54	+
Pumlumon	5150	-0.82	-3.19	++++	-0.18	-1.34	–
Redesdale	5109	-1.79	-3.31	++++	-0.33	-1.02	+
River Etherow	5158	-1.96	-3.06	++	-0.77	-1.90	–
River Mharcaidh	5103	-0.68	-3.16	++++	-0.05	-0.43	–
Scoat Tarn	5159	-0.84	-2.72	+	0.02	0.15	–
Stoke Ferry	5004	-2.62	-3.26	+++++	-0.46	-0.99	+
Strathvaich Dam	5010	-0.44	-2.91	+++	-0.09	-1.06	–
Thorganby	5117	-2.99	-3.12	++++	-0.54	-1.21	++
Tycanol Wood	5123	-0.57	-2.09	+++	0.00	-0.02	–
Wardlow Hay Cop	5120	-2.79	-3.13	+++++	-0.28	-0.83	–
Whiteadder	5106	-1.68	-3.20	++++	-0.46	-1.35	+
Woburn	5127	-2.63	-3.45	++++	-0.12	-0.31	–
Yarner Wood	5008	-0.67	-2.26	++	0.14	0.79	–

### 3.3 Particulate Sulphate Measurements

Daily sulphate concentrations continue to be measured at 5 sites. Measurements at Strathvaich Dam, Glen Dye and Stoke Ferry were discontinued in 2001. Daily sulphate measurements are a key input to a number of areas of particulate matter research. For example, quantification of secondary inorganic aerosol (SIA), of which particulate sulphate is a component, remains an important component of atmospheric particulate matter, especially as precursor emissions from shipping may increase in the future, while land based emissions of primary particulate matter and SIA precursors are controlled.

In addition, daily sulphate measurements used within the particulate matter receptor model are used by Defra's Airborne Particulate Expert Group to verify the scaling coefficients used for the secondary inorganic aerosol contribution.

AQEG has recommended time-resolved measurements of sulphate, nitrate, elemental and organic carbon and PM<sub>2.5</sub> in rural urban and roadside locations. The aim of these measurements is to approach mass closure for PM measurements; mass closure is an important prerequisite for robust policy development studies. The daily sulphate measurements contribute to mass closure.

Although the measurements from the expanded nitric acid monitoring network will become the primary source of data for mapping particulate sulphate (and other components), the daily measurements from the daily particulate sulphate programme will also enable some extrapolation of the denuder measurements.

Retention of the long running daily sulphate dataset is recommended for this key component of PM<sub>2.5</sub>. Measurements of sulphate are recorded as far back as 1973 at Eskdalemuir. It would be counterproductive to stop these measurements, particularly when concern is focussed on the long-term health effects of PM, and there is considerable uncertainty surrounding the importance of recent and long-term exposure along with the time lag of effects.

High frequency particulate sulphate measurements are also of particular interest to EMEP.

#### 3.3.1 Trends in Particulate Sulphate

Figure 3-8 shows the monthly mean and running annual mean concentrations of particulate sulphate at Eskdalemuir. The decrease in the concentration of particulate sulphate is much less marked than that of sulphur dioxide over the corresponding period (Hayman *et al*, 2007a). There is much variation around the running annual mean and an apparent increase in sulphate concentrations from 1978 to 1984. This is then followed by a decrease in annual mean concentrations from 1992 to 2004, and a very slight increase to mid-2007. The higher concentrations noted in 2003 are evident in this figure. From 1978, the annual average particulate sulphate concentration at Eskdalemuir declined from around 1.0 µg [SO<sub>4</sub> as S] m<sup>-3</sup> to around 0.35 µg [SO<sub>4</sub> as S] m<sup>-3</sup> in 2005, rising slightly to 0.45 µg [SO<sub>4</sub> as S] m<sup>-3</sup> in 2007.

Figure 3-9 shows a time-series of the annual mean concentration at the 5 currently operational sites: Eskdalemuir, Lough Navar, Barcombe Mills, Yarner Wood and High Muffles. Concentrations have been consistently highest at Barcombe Mills and lowest at Lough Navar, reflecting the proximity of these sites to the European mainland. The relative concentrations at each site are seen to follow a similar trend over the years; the mean concentrations at all sites decreased until about 1992, remained somewhat steady until about 1996 and then decreased rapidly until about 1999, where they remained more or less constant until 2002. 2003 was a photochemically active year – a number of periods of elevated concentrations were experienced, thus influencing the annual mean concentrations. Annual mean concentrations were noticeably lower in 2004, before rising slightly at most sites in 2005, and again 2006. Poor equipment reliability and subsequent low data capture meant that valid, reliable particulate sulphate annual means were only obtained for 1 of the 5 sites in 2007. However, the 2007 annual mean at Eskdalemuir shows a continuing slight upward trend from the 2004 low.

**Figure 3-8 Trends in Particulate Sulphate Concentrations observed at Eskdalemuir since 1978**

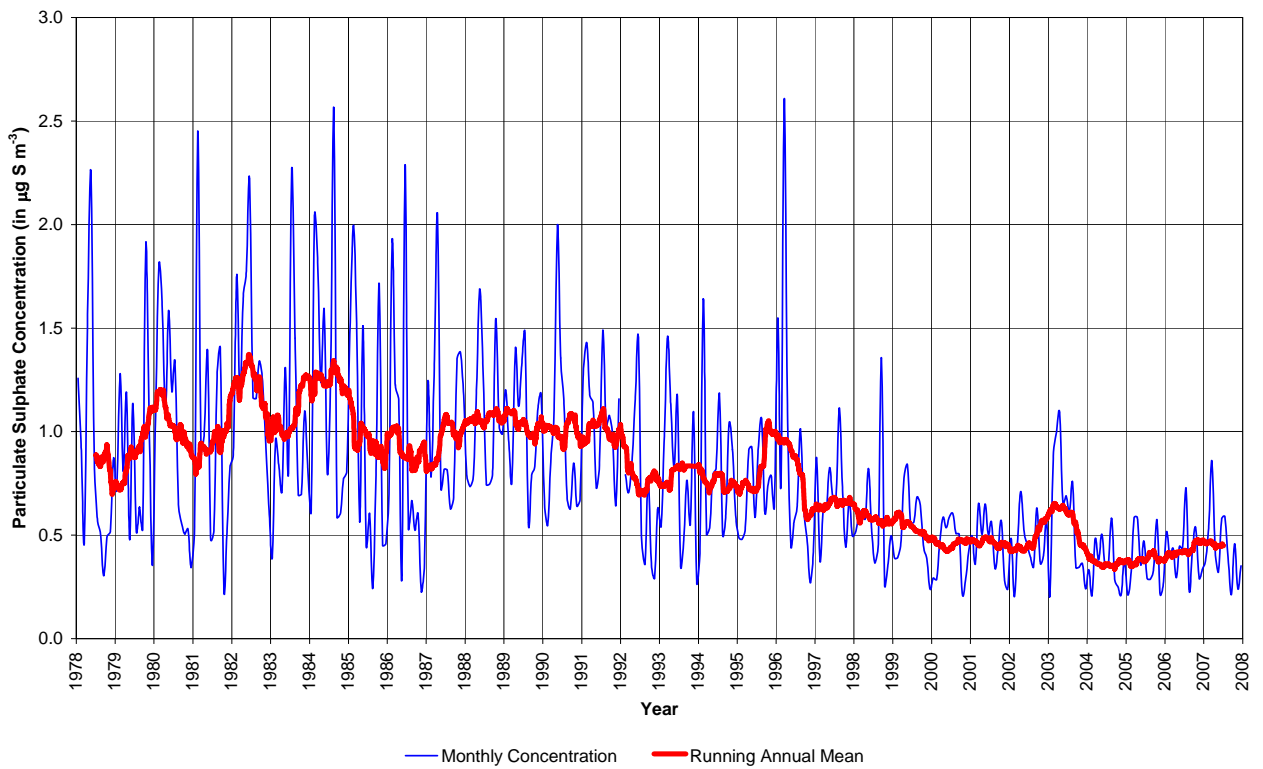

**Figure 3-9 Annual mean concentrations of particulate sulphate at the daily sites, from 1986 to 2007 ( $\mu\text{g SO}_4^{2-}$  as  $\text{S m}^{-3}$ )**

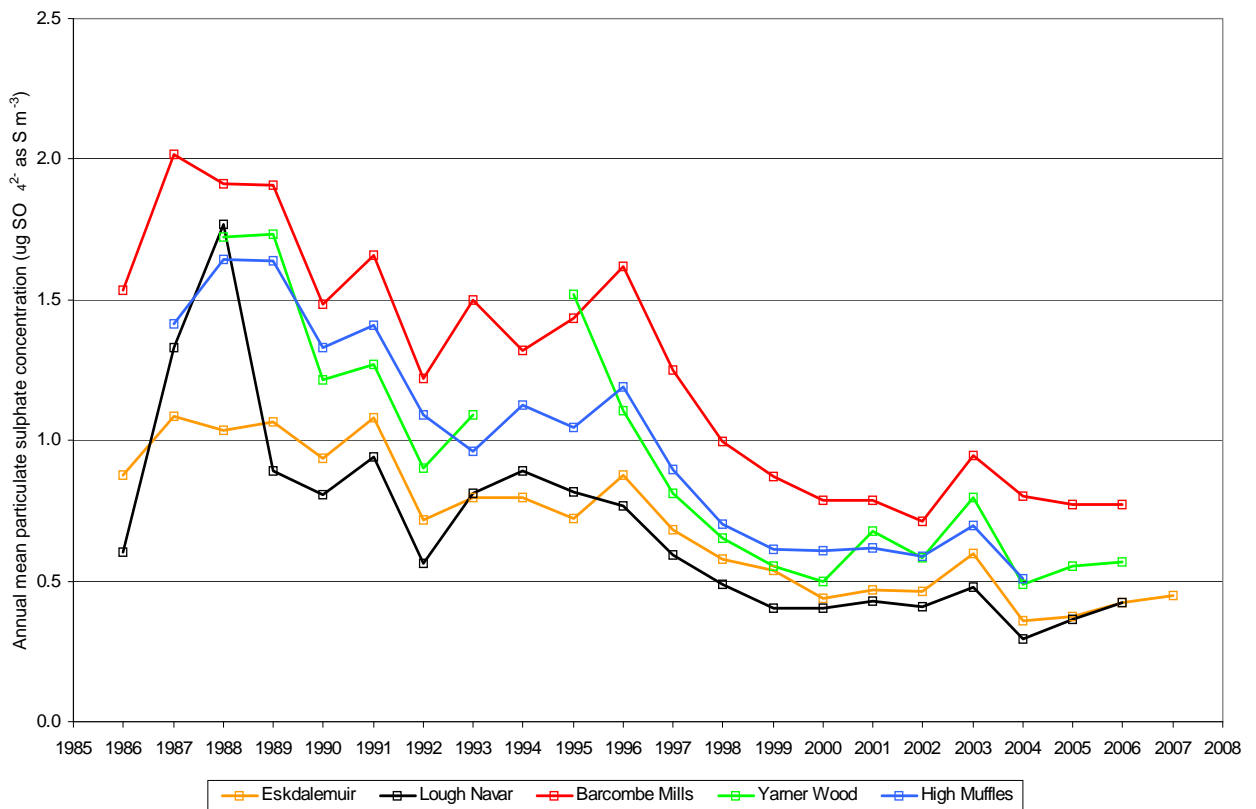



## 3.4 Nitrogen Dioxide Measurements

### 3.4.1 The 2007 Measurements

The determination of nitrogen dioxide at rural locations in the acid rain network provides a key input to the mapping of nitrogen dioxide in the United Kingdom [Stedman, 1997]. The individual and annual mean nitrogen dioxide diffusion tube measurements, made during 2007 are presented in Appendix 4.

### 3.4.2 Triplicate Measurements

Exposure of triplicate diffusion tubes has commenced at three sites where there are (or will be) co-located automatic analysers. Triplicate measurements commenced at Yarner Wood and Eskdalemuir in 2006. Triplicate exposures at Harwell began in January 2007, coinciding with the relocation of the rain collector and diffusion tube from Compton.

Diffusion tube precision and accuracy of the triplicate measurements were determined using the DiffTPAB\_v03.xls spreadsheet (updated Nov 2006)<sup>5</sup>. The spreadsheet calculates the annual mean, standard deviation, Coefficient of Variation (CV) and the 95% confidence intervals of the mean.

The CV of the diffusion tube triplicates represents their precision. This value is used to carry out a data quality check on the replicates for each period. When the CV of a single period is above 20%, the period measurement is considered of poor precision. All others (below 20%) are considered of good precision. The average CV of the different monitoring periods is used to assess the overall precision of the survey. If the average CV is above 10%, the survey is considered to be of poor precision.

Overall, diffusion tube measurements for Eskdalemuir, Yarner Wood and Harwell showed good precision in 2007. For all but one of the individual monitoring periods considered of poor precision, there was one obvious outlying measurement; these outlying points were removed from the dataset.

Individual diffusion tube measurements from the triplicate sites are also presented in Appendix 4.

### 3.4.3 Comparison with Other Measurements

Since 2004, nitrogen dioxide measurements have been made using automatic monitoring instruments at a number of rural locations in the UK, primarily in England. Four of these analysers are currently co-located with Acid Deposition monitoring sites: Eskdalemuir, Yarner Wood, High Muffles and Harwell. In addition, Barcombe Mills acid deposition and Lullington Heath automatic analysers are located sufficiently closely to acid deposition sites that the measurements can also be compared. Table 3-3 overleaf compares the annual mean concentrations determined at these sites for 2007.

Table 3-3 shows excellent agreement between the pairs of measurements at Barcombe Mills / Lullington Heath. Diffusion tube measurements are widely seen to be higher than those made by automatic analysers, and this trend is observed at Yarner Wood, High Muffles and most noticeably Harwell in 2007. Eskdalemuir was the only site of the five where the diffusion tube annual mean was lower than the automatic data.

<sup>5</sup> Available from the UK Air Quality Archive – LAQM Tools: <http://www.airquality.co.uk/archive/laqm/tools.php>

Site	Diffusion Tube	Automatic
Eskdalemuir *	4.2	5.0
Yarner Wood *	6.3	5.6
High Muffles	8.5	6.4
Harwell * #	16.8	12.2
Barcombe Mills / Lullington Heath	9.9	10.4

\* Triplicate diffusion tube monitoring undertaken at these sites

# Diffusion tube data capture 73% - annual mean an indication only

### 3.4.4 Trends in Nitrogen Dioxide

UK total emissions of nitrogen oxides have decreased since 1990 with the switch from coal to gas for power generation and the introduction of catalytic converters on petrol-engined vehicles. Given the relatively poor precision of the diffusion tube method at low concentrations, the fall in nitrogen dioxide concentrations is most clearly observed at the relatively high concentration sites such as High Muffles and Barcombe Mills, although lower concentration sites such as Yarner Wood, Strathvaich Dam Eskdalemuir also show evidence of a decline.

Figure 3-10 presents the annual average concentrations for nitrogen dioxide, determined at 8 monitoring sites between 1997 and 2007. The figure shows 7 current monitoring sites and also Stoke Ferry, which was operational until the end of 2005. Nitrogen dioxide concentrations in 2007 were in line with those measured during 2006.

### 3.4.5 Concentration Maps

Diffusion tube measurements have been used to produce a map of the UK rural nitrogen dioxide concentrations for 2007, as shown in Figure 3-11 (bottom right-hand panel). The figure also shows the 2000 to 2006 maps for comparison. The highest concentrations in 2007 were observed in the south east of England with an annual mean concentration of 7.0 ppb measured at Flatford Mill. In the main, this reflects the proximity to the sampling sites of roads and other aspects of urbanisation. The 2006 and 2007 maps do not include concentrations from Woburn (Buckinghamshire), the highest concentration site in 2005 (11.2 ppb), as this site was closed at the end of 2005. The maps show little difference in the spatial patterns between 2000 and 2007 and some evidence of a decrease in nitrogen dioxide concentrations across the UK.

Historically, these UK maps, based on diffusion tube measurements, defined the rural nitrogen dioxide concentration field, upon which urban contributions were superimposed. With the introduction of automatic analysers, mainly in England, a hybrid approach is now adopted in the mapping work (Kent *et al.*, 2006). The preparation of the urban-enhanced maps is undertaken under another contract (*Pollution Climate Mapping*). These measurements have been provided to the Pollution Climate Mapping project team.

Figure 3-10 Time Series of Annual Nitrogen Dioxide Concentrations (ppb) – Stoke Ferry now closed

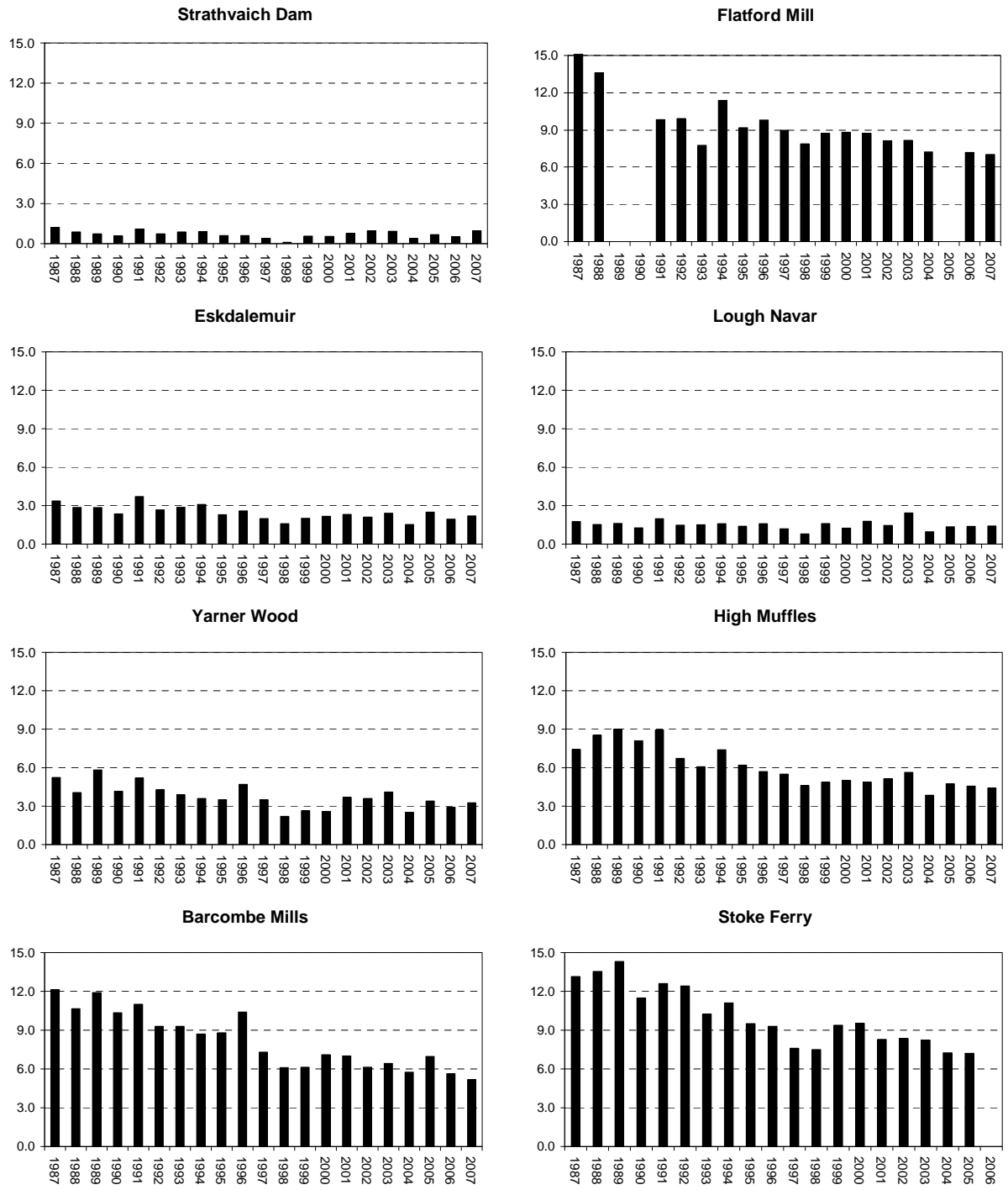
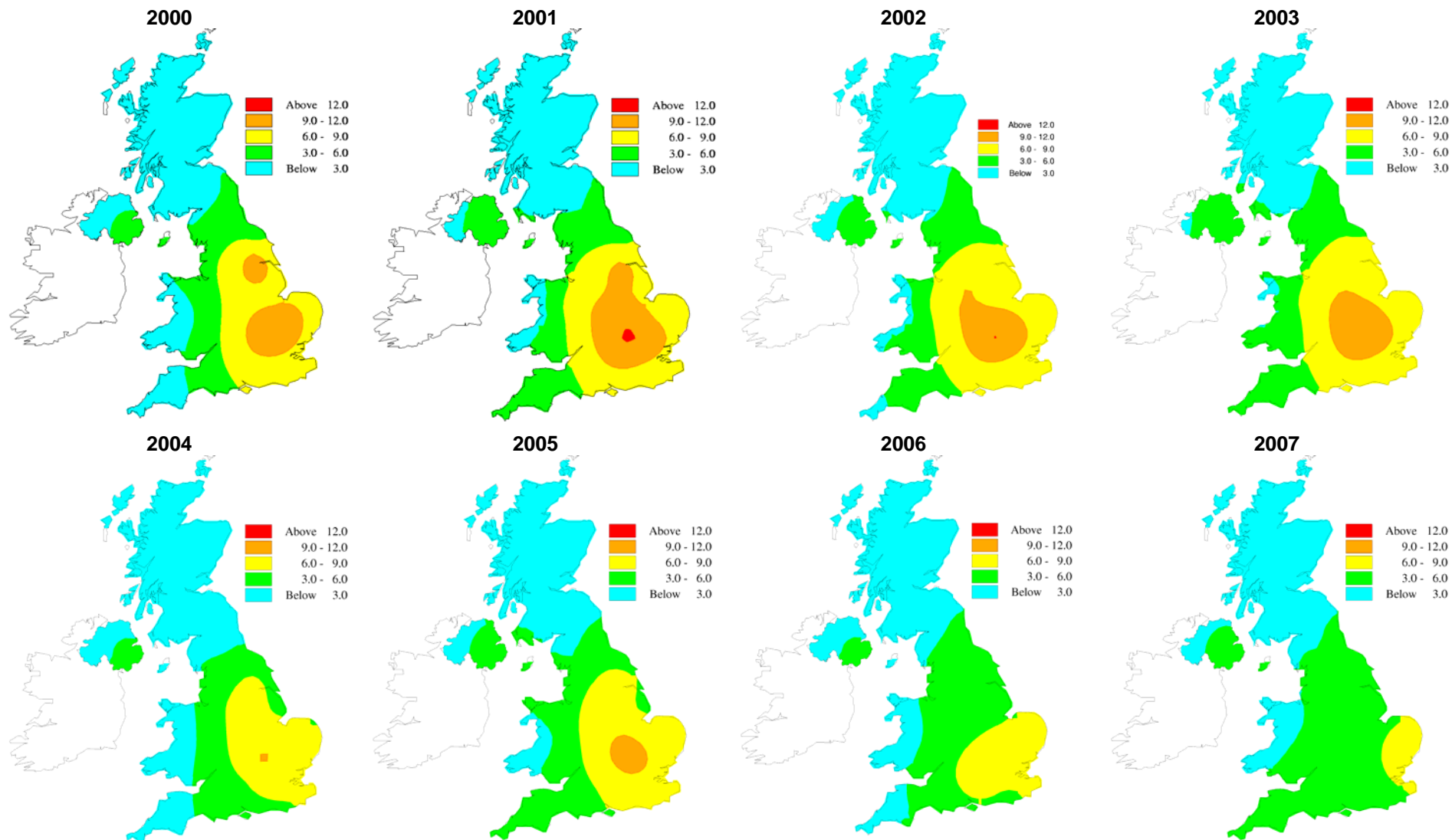

Figure 3-11 Interpolated Concentration Maps of Nitrogen Dioxide (in ppb) for 2000 – 2007



# 4 Nitric Acid Monitoring Network

## 4.1 Introduction

The UK Nitric Acid Monitoring Network has been in operation since September 1999, providing data on nitric acid, particulate nitrate and other acidifying species as part of the UK Acid Deposition Monitoring Network. The aim of these measurements is to explore spatial patterns, compare results with dispersion models, seasonality and contribute to national nitrogen deposition estimates.

In the first phase of the network, monitoring was implemented on a monthly basis at 12 sites using the CEH DELTA denuder system in an integrated fashion with the UK National Ammonia Monitoring Network (NAMN). The aim of these measurements is to explore spatial patterns, compare results with dispersion models, seasonality and contribute to national deposition estimates. To improve on the national spatial coverage, the HNO<sub>3</sub> monitoring network was increased from 12 to 30 sites in the second phase of the network, starting January 2006. The new expanded HNO<sub>3</sub> network also replaced measurements of SO<sub>2</sub> and SO<sub>4</sub><sup>2-</sup> previously made under the Rural Sulphur Dioxide Monitoring Programme, which terminated at the end of 2005. In this section, the sampling methods and measurement data from the new expanded 30-site network for 2007 are summarised and compared against previous years.

A map of the HNO<sub>3</sub> monitoring network is shown in Figure 4-1, where nitric acid and related species are monitored on a monthly basis at (A) 12 locations (from September 1999) and (B) 30 locations (from January 2006). Details of the sites and operators are summarised in Table 4-1.

Figure 4-1 Maps of (A) the original 12 monitoring sites and (B) the expanded 30 site network

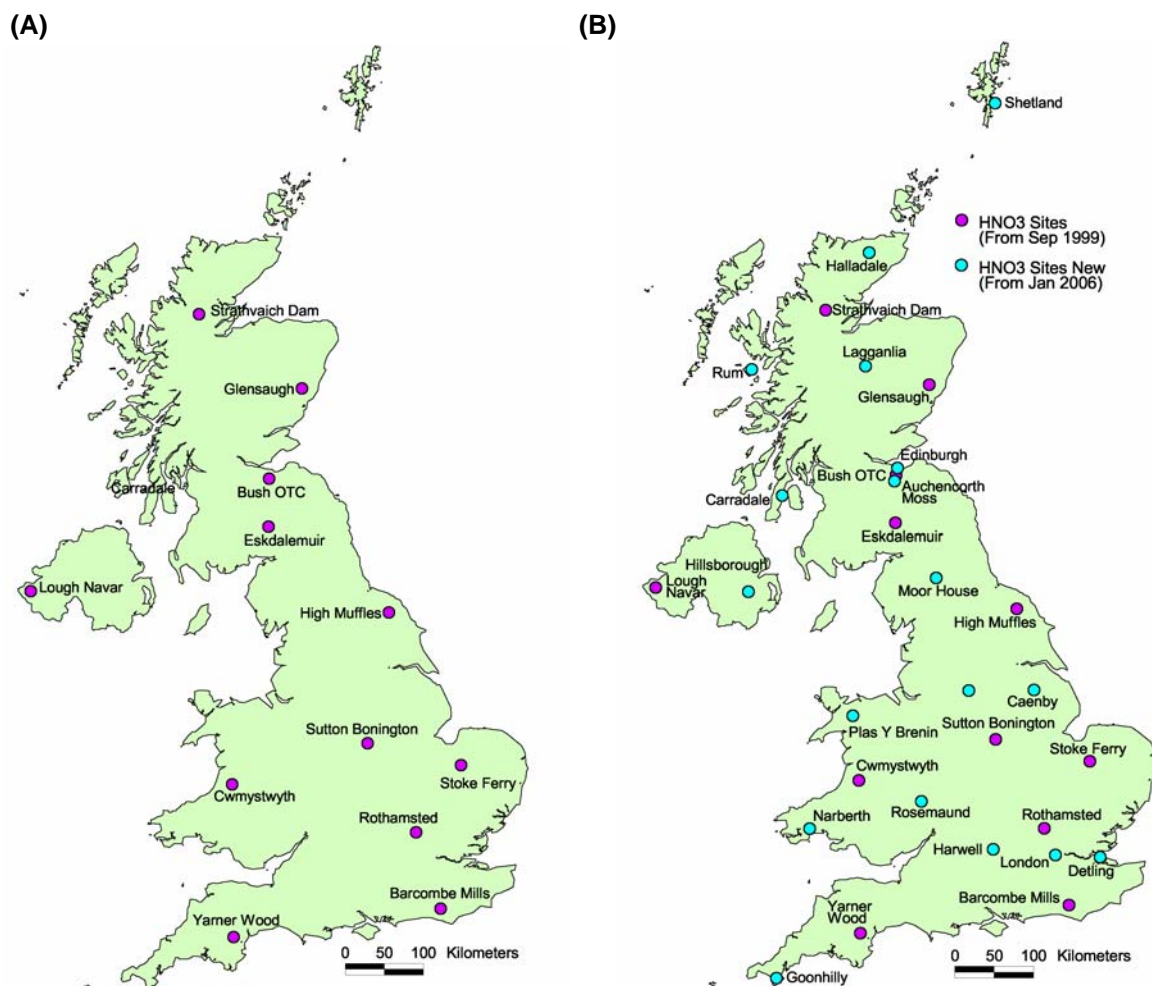

<b>Table 4-1 Sites in the HNO<sub>3</sub> network using an extension of the DELTA system at NAMN sites</b>				
Site code	Site name	OS Grid Ref	Start date	Local Site Operating Body
1	Bush OTC	NT243642	Sept 1999	CEH Edinburgh
21	Glensaugh	NO664789	Sept 1999	Macaulay Land Use Research Institute (MLURI)
24	Rothamsted	TL123129	Sept 1999	IACR
30	Strathvaich Dam	NH348750	Sept 1999	CLOVA Environmental Research
31	Eskdalemuir	NT235030	Sept 1999	Met Office
32	High Muffles	SE776939	Sept 1999	Forest Research
33	Stoke Ferry	TL700988	Sept 1999	Borough Council of King's Lynn & West. Norfolk
34	Yarner Wood	SX789788	Sept 1999	Natural England
40	Sutton Bonington	SK505268	Sept 1999	University of Nottingham
45	Lough Navar	IH065545	Sept 1999	DARDNI
70	Cwmystwyth	SN771742	Sept 1999	ADAS
83	Barcombe Mills	TQ438149	Sept 1999	South East Water
6B	Rosemaund	SO564476	Jan 2006	ADAS
8C	Narberth	SN146127	Jan 2006	Pembrokeshire County Council
12	Halladale	NC902488	Jan 2006	Fountain Forestry
18	Auchencorth Moss	NT221562	Jan 2006	CEH Edinburgh
19	Shetland	HU500400	Jan 2006	Met Office (Lerwick)
22	Moor House	NY751334	Jan 2006	CEH Lancaster
36C	London Cromwell Road	TQ266791	Jan 2006	CG Images
41	Lagganlia	NH856037	Jan 2006	CEH Banchory
44	Hillsborough	IJ243577	Jan 2006	DANI
47	Rum	NM408992	Feb 2006	Scottish Natural Heritage
60C	Edinburgh St Leonards	NT262731	Jan 2006	City of Edinburgh Council
77	Carradale	NR798378	Jan 2006	SEPA
97	Detling	TQ801597	Feb 2006	Maidstone Environmental Health
98	Harwell	SU474863	May 2006	AEA
99	Ladybower	SK164892	Feb 2006	Nick Hewitt
100	Plas Y Brenin	SH716578	May 2006	Countryside Council for Wales (CCW)
102	Caenby	SK993900	Feb 2006	West Lindsey District Council
103	Goonhilly	SW723214	Jan 2006	BT

## 4.2 Method and Data Collection

The Nitric Acid Monitoring Network uses an extension of the DELTA system at the NAMN sites to additionally sample HNO<sub>3</sub> and related species. The sampling train used in the DELTA system is shown in Figure 4-2.

HNO<sub>3</sub>, SO<sub>2</sub> and HCl are removed by the first set of K<sub>2</sub>CO<sub>3</sub> / glycerol coated denuders, and a second set of citric acid coated denuders removes NH<sub>3</sub>. Two sets of coated filter papers in a two-stage filter-pack at the end of the sampling train collect the aerosol components. The first filter is impregnated with K<sub>2</sub>CO<sub>3</sub> / glycerol to sample aerosol NO<sub>3</sub><sup>-</sup>, SO<sub>4</sub><sup>2-</sup>, Cl<sup>-</sup> plus the base cations Na<sup>+</sup>, Ca<sup>2+</sup> and Mg<sup>2+</sup>, followed by a citric acid coated paper to sample aerosol NH<sub>4</sub><sup>+</sup>.

Returned samples are stored in a cold room at 4 °C until analysis. The carbonate-coated denuders and filters are extracted into 5 ml of 0.05 % H<sub>2</sub>O<sub>2</sub>. The initial uncoated short length of Teflon inlet is not extracted as this only serves to develop a laminar flow through the coated denuders. (Tests have shown that <1% of the total is captured in this portion.) Aqueous extracts from the denuders and filters are sent to Harwell Scientifics on a monthly basis for analysis by ion chromatography. Denuder sample extracts are analysed for NO<sub>3</sub><sup>-</sup>, SO<sub>4</sub><sup>2-</sup> and Cl<sup>-</sup> and filter sample extracts are analysed for NO<sub>3</sub><sup>-</sup>, SO<sub>4</sub><sup>2-</sup>, Cl<sup>-</sup>, Na<sup>+</sup>, Mg<sup>2+</sup> and Ca<sup>2+</sup>.

The acid-coated denuders and filter papers are extracted into 3 ml and 4 ml of deionised H<sub>2</sub>O respectively. These sample extracts are analysed for NH<sub>4</sub><sup>+</sup> on the high sensitivity AMFIA (AMmonia Flow Injection Analysis) system (developed at ECN, Petten, NL) based on the selective dialysis of ammonium across a membrane at high pH with subsequent analysis of conductivity.

Monitoring of gaseous NH<sub>3</sub> and aerosol NH<sub>4</sub><sup>+</sup> is carried out as part of the NAMN, and measurements are reported separately under that contract. However, NH<sub>3</sub> and NH<sub>4</sub><sup>+</sup> data are used in this report to aid interpretation of data obtained under the Nitric Acid Monitoring Network.

**Figure 4-2 CEH DENuder for Long-Term Atmospheric sampling (DELTA) for monthly measurements of nitric acid, nitrate and associated acids and aerosols**

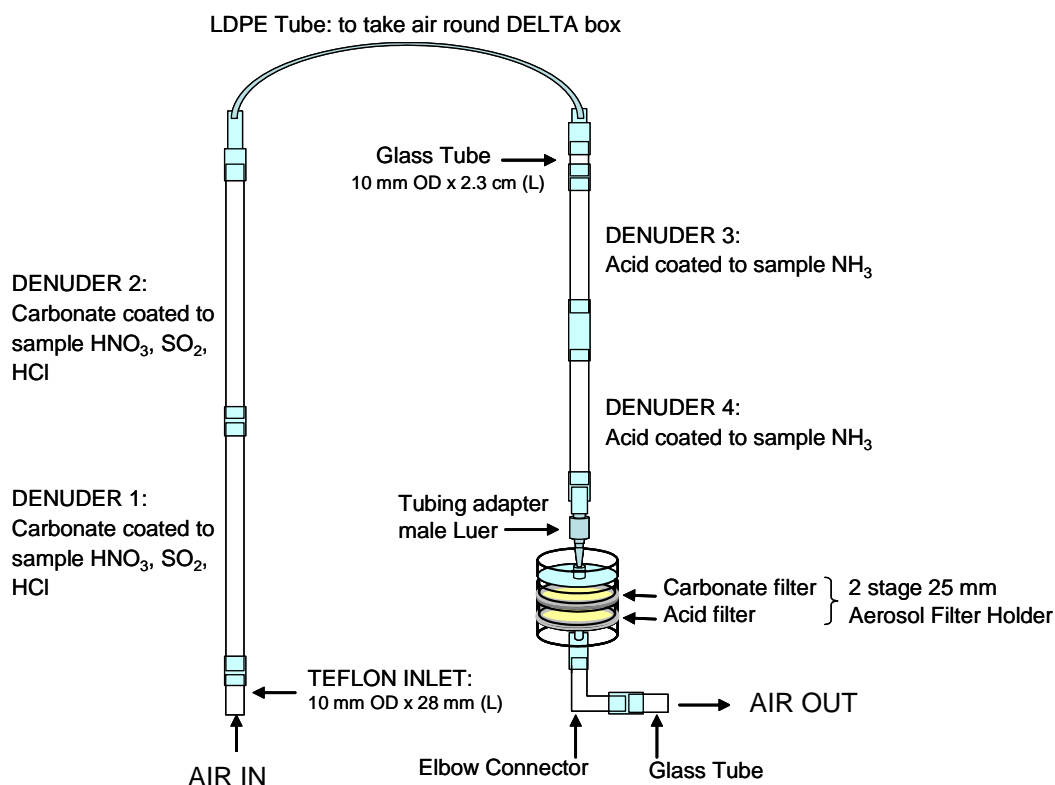

### Analysis and Calculations

The amount of a gas collected ( $Q$ ) on a denuder due to air sampling is given by:

$$Q = (c_e - c_b) \cdot v \tag{1}$$

where  $c_e$  is the liquid concentration of an exposed tube,  $c_b$  is the liquid concentration of a blank tube and  $v$  is the liquid volume of the extraction solution. The air concentrations ( $\chi_a$ ) of the gas of interest is then determined as:

$$\chi_a = Q / V \tag{2}$$

where  $V$  is the effective volume of air sampled. For denuder samples, this is found directly from the gas meter readings and is typically 15 m<sup>3</sup> per month.

The use of two denuders in series allow for the determination of capture efficiency, by comparing the amounts of trace gas in both. An infinite series correction factor, based on the capture efficiency, is applied for trace gas not captured. The corrected air concentration of the gas ( $\chi_a$  (corrected)) is then determined as:

$$\chi_a \text{ (corrected)} = \chi_a \text{ (Denuder 1)} * \frac{1}{[1 - (\chi_a \text{ (Denuder 2)} / \chi_a \text{ (Denuder 1)})]} \tag{3}$$

The absolute amount of the correction is added to the value for the acid gas, and subtracted from the aerosol value. At a typical capture efficiency of 90% in the first denuder, the correction represents 1% of the corrected air concentration. At 80%, 75% and 70% capture, the correction amounts to 6%, 11% and 17% of the total, respectively. Below 60% capture efficiency, the correction amounts to greater than 50% and should not be applied. The air concentration of the trace gas is then determined as:

$$\chi_a = \chi_a \text{ (Denuder 1)} + \chi_a \text{ (Denuder 2)} \tag{4}$$

### 4.3 Measurements

#### 4.3.1 Denuder Capture Efficiency

The use of 2 glass denuders in series allows the capture efficiency of every sample to be assessed by comparing the amount of HNO<sub>3</sub>/SO<sub>2</sub>/HCl in both tubes. A collection efficiency correction is applied to the measurement based on the capture efficiency. Where less than 75% of the total captured is recorded in the first denuder, data are marked as being less certain. The monthly averaged denuder capture efficiencies from the 30 monitoring sites for HNO<sub>3</sub>, SO<sub>2</sub> and HCl are shown in Figure 4-3. The quality control using a double denuder system confirms that the capture efficiency in the denuders is adequate and that the correction factors are small (typically ~ 5%).

Figure 4-3 Monthly mean denuder capture efficiency for NH<sub>3</sub>, HNO<sub>3</sub>, SO<sub>2</sub> and HCl from 30 monitoring sites (= amount in 1st denuder / (Amounts captured in 1st + 2nd denuders)\*100 %)

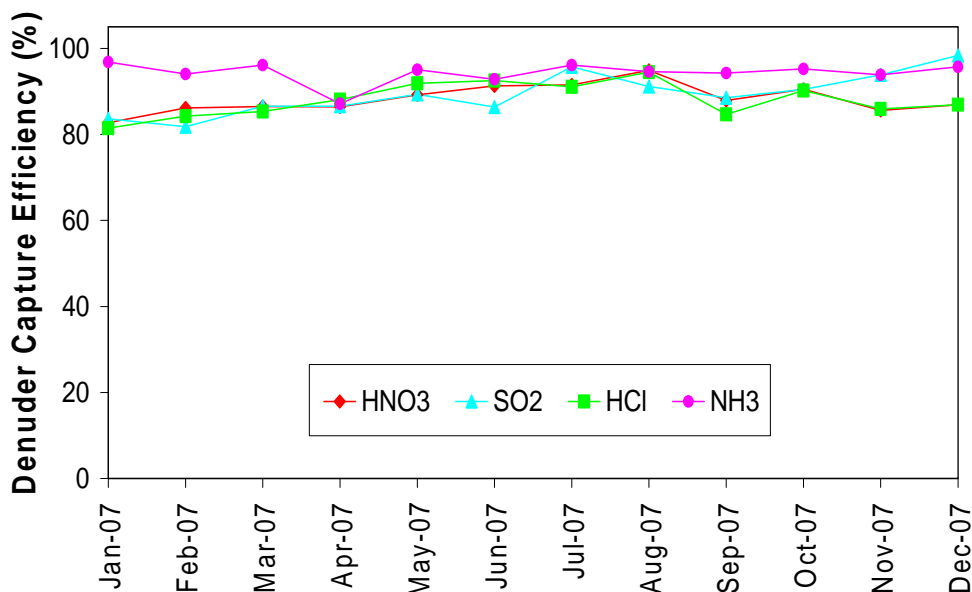



### 4.3.2 Measurement Reproducibility

At the Bush OTC monitoring site, 2 DELTA systems are operated in parallel to provide an ongoing assessment of the precision of the DELTA approach. Excellent agreement was achieved with the replicate sampling (e.g. an annual average difference of  $\pm 2\%$  in  $\text{HNO}_3$ , Figure 4-4).

In Figure 4-5, a comparison of replicate measurements of the other components are made, which shows good agreement for all components.

**Figure 4-4 Gaseous  $\text{HNO}_3$  and aerosol  $\text{NO}_3^-$  data from two parallel DELTA systems at Bush OTC**

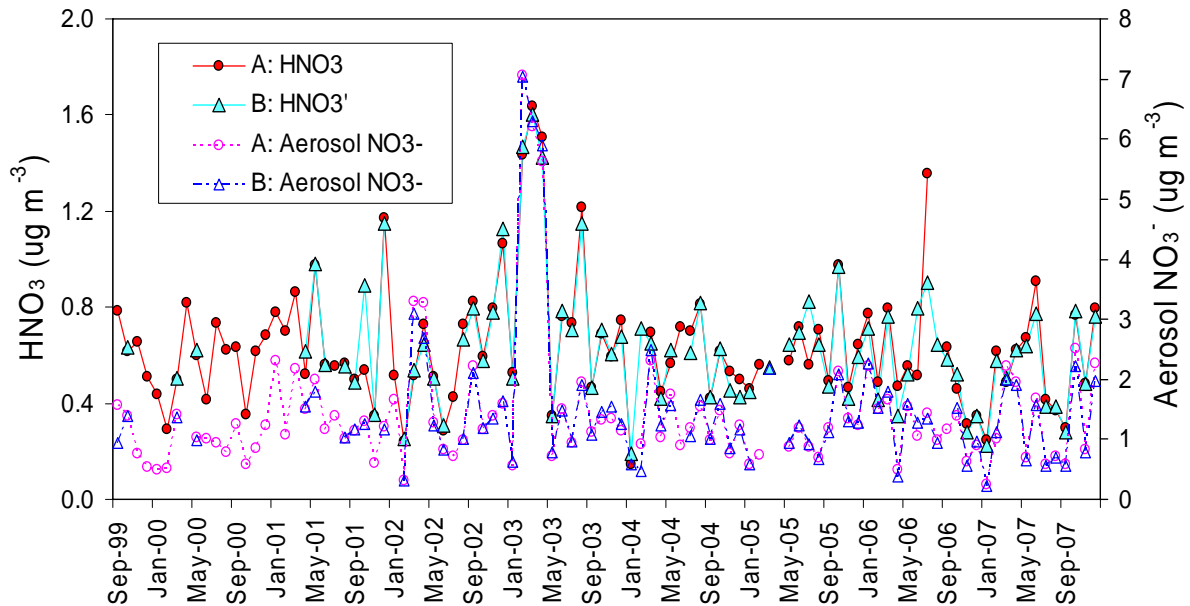

**Figure 4-5 Correlation plots of replicate DELTA measurements made at Bush OTC**

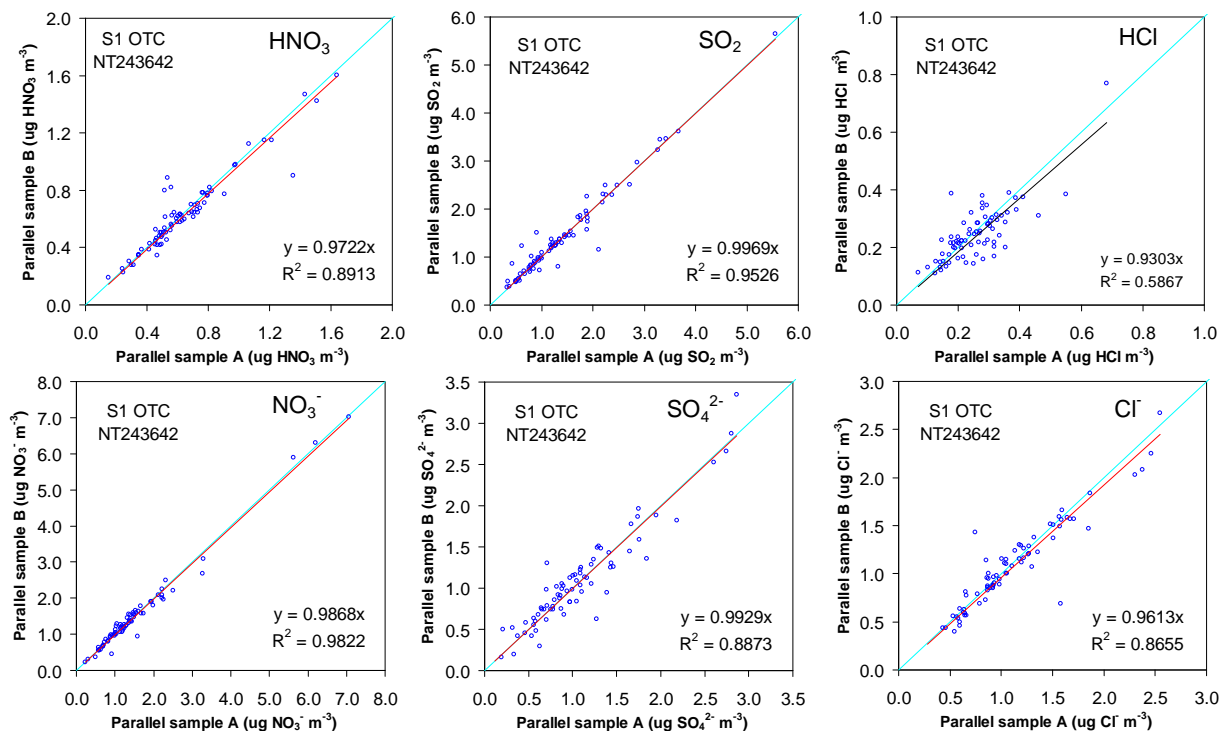

### 4.3.3 Measurements and Trends – 2007

The complete set of monthly measurements and statistical summaries of the acid gases and acidic and base cation aerosol components, made in 2007 can be found in Appendix 5 of this data report. Graphs showing the below  $\text{HNO}_3 / \text{NO}_3^-$ , and  $\text{SO}_2 / \text{SO}_4^{2-}$  trends are presented in Appendix 5. Parallel analyses have also been made for  $\text{HCl} / \text{Cl}^-$  and  $\text{NH}_3 / \text{NH}_4^+$  (as part of the NAMN), as well as the base cations  $\text{Ca}^{2+}$ ,  $\text{Mg}^{2+}$  and  $\text{Na}^+$ .

#### Monthly $\text{HNO}_3 / \text{NO}_3^-$ Trends

Monthly monitored concentrations of gaseous  $\text{HNO}_3$  and particulate  $\text{NO}_3^-$  are found to be relatively invariant at a monthly level and have a weak seasonal variability. The annual cycle for  $\text{HNO}_3$  and  $\text{NO}_3^-$  has an observed maximum during late spring and early summer, which may be related to increased ozone concentrations during the season and an enhancement of  $\text{HNO}_3$  formation. During the winter months, low temperature and high humidity favour the formation of  $\text{NH}_4\text{NO}_3$  from the gas phase  $\text{NH}_3$  and  $\text{HNO}_3$ . Coupled with changes in boundary layer conditions, this produces the winter minimum in the cycle. The ratio of the concentrations of  $\text{HNO}_3$  and  $\text{NO}_3^-$  is similar throughout the year; fluctuations in the ratio are influenced by the loss of  $\text{HNO}_3$  due to dry deposition.

The largest  $\text{HNO}_3$  concentrations were measured in southeast England (e.g. London: 2007 annual mean =  $3.7 \mu\text{g HNO}_3 \text{ m}^{-3}$ , range =  $2.7 - 4.8 \mu\text{g HNO}_3 \text{ m}^{-3}$ ) and smallest in the remote north and western areas of Britain. The lowest  $\text{HNO}_3$  concentrations were observed at remote locations away from sources, and where the influence of continental Europe was minimal (e.g. Lough Navar, Northern Ireland: 2007 annual mean =  $0.24 \mu\text{g HNO}_3 \text{ m}^{-3}$ , range =  $0.05 - 0.5 \mu\text{g HNO}_3 \text{ m}^{-3}$ ).

#### Monthly $\text{SO}_2 / \text{SO}_4^{2-}$ Trends

Monthly monitored concentrations of gaseous  $\text{SO}_2$  and particulate  $\text{SO}_4^{2-}$  have also been compared. The figures illustrate that concentrations of  $\text{SO}_2$  have a seasonal variability, with winter exceeding summer values by between 50% and a factor of 2. During the winter months, higher emissions of  $\text{SO}_2$ , coupled with stable conditions resulting in less vertical dispersion, produce the winter maximum in the cycle.

The highest  $\text{SO}_2$  concentrations occurred at sites close to the UK's major emission sources. At Sutton Bonington, located 2 km south of the 2000 MW capacity coal-fired Ratcliffe on Soar power station, a peak concentration of  $8.6 \mu\text{g SO}_2 \text{ m}^{-3}$  was measured in August 2007 (annual mean =  $2.4 \mu\text{g SO}_2 \text{ m}^{-3}$ , range =  $0.6 - 8.6 \mu\text{g SO}_2 \text{ m}^{-3}$ ). The lowest concentrations of  $\text{SO}_2$  were also monitored at remote sites in less populated areas: Lough Navar in Northern Ireland, and Lagganlia, Strathvaich Dam and Halladale in the Scottish Highlands.

#### Relationships Between Gaseous and Aerosol Components

Scatter plots of the concentration of gas and aerosol phases of the different components show that there are significant spatial correlations between the concentrations of the different pollutants (Figure 4-6). Much of this may be related to correlation in the emission distribution of precursor gases, or the effect of long-range transport of aerosol across the UK and from Europe.

The comparison of the gas phase concentrations shows that there is more  $\text{NH}_3$  than either  $\text{SO}_2$  or  $\text{HNO}_3$  at these sites (on a molar basis), while  $\text{HNO}_3$  concentration is comparable to  $\text{SO}_2$ . For the aerosol components, the close coupling between acidic ( $\text{NO}_3^-$ ,  $\text{SO}_4^{2-}$ ) and basic ( $\text{NH}_4^+$ ) aerosol components is demonstrated by the high correlations. As with the gases, reduced nitrogen ( $\text{NH}_4^+$ ) is in molar excess over  $\text{SO}_4^{2-}$  and  $\text{NO}_3^-$ . However, aerosol  $\text{NO}_3^-$  is in molar excess over  $\text{SO}_4^{2-}$  and is even somewhat larger in terms of equivalents of  $\text{H}^+$ . Whilst there is no discernible relationship between particulate  $\text{Cl}^-$  and  $\text{NH}_4^+$ , there is a near 1:1 relationship between  $\text{Cl}^-$  and  $\text{Na}^+$ , consistent with a marine origin for these ions in the UK. The high correlations between the aerosol species also indicate the quality of the measurements, since uncertainty in the measurements on a monthly basis would propagate through to scatter in these plots.

**Figure 4-6 Scatter plots showing the relationships between concentrations of HNO<sub>3</sub>, SO<sub>2</sub>, NH<sub>3</sub>, NO<sub>3</sub><sup>-</sup>, SO<sub>4</sub><sup>2-</sup>, NH<sub>4</sub><sup>+</sup>, Cl<sup>-</sup> and Na<sup>+</sup> from the monthly measurements in 2007 at all 30 sites**

**(A) Gaseous Components**

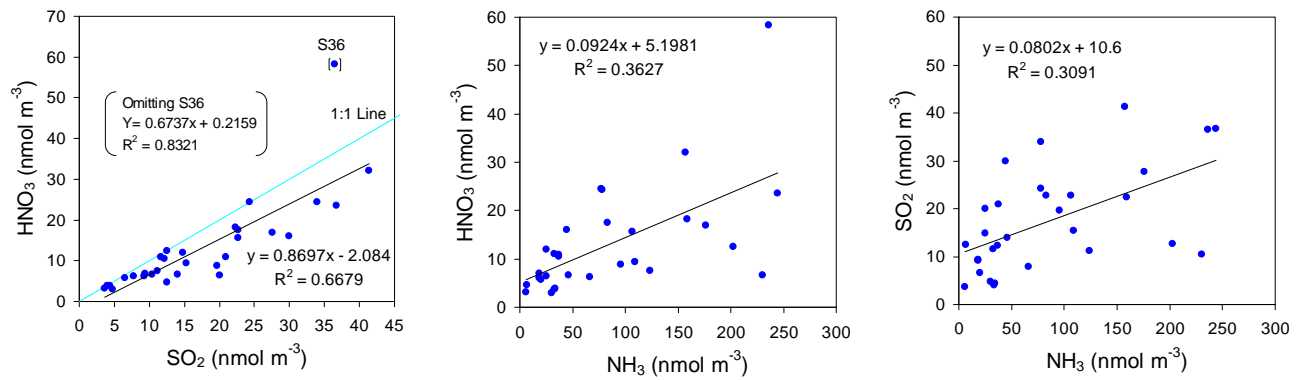

**(B) Particulate Components**

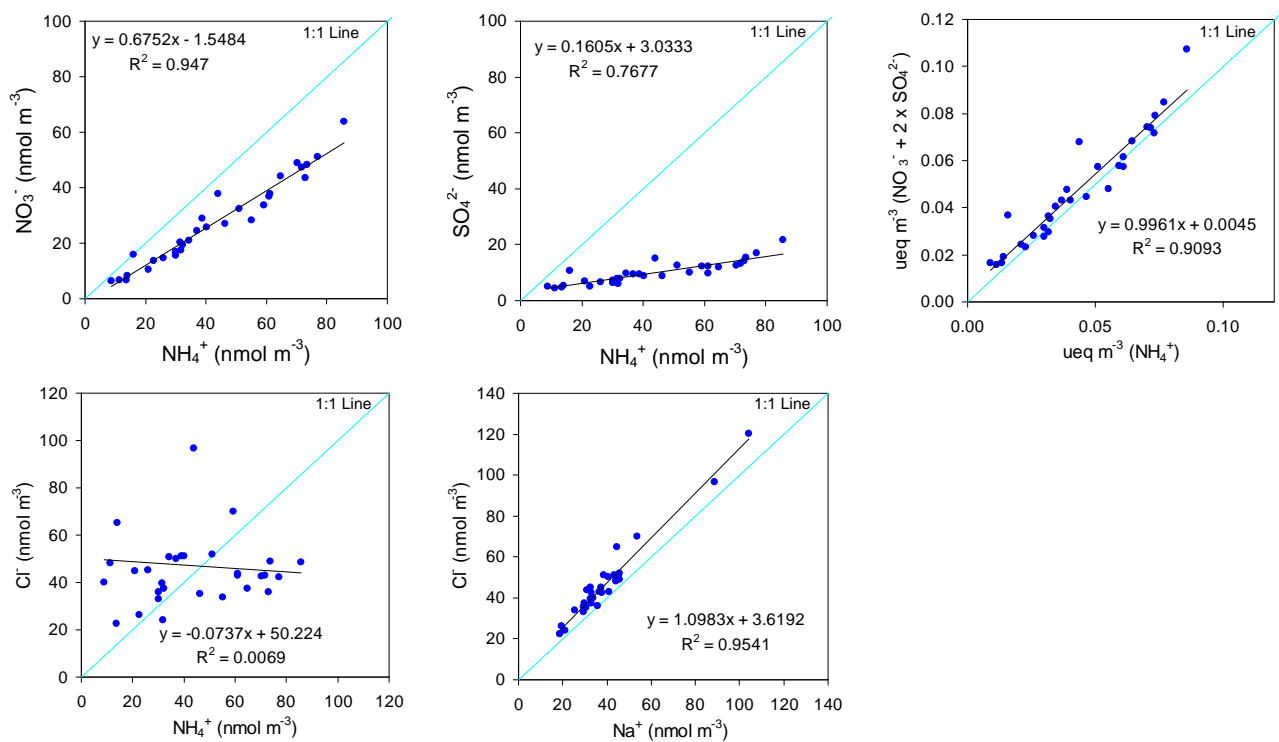

**Temporal Trends**

The average seasonal variations across all sites in species measured in the network are shown in Figure 4-7. This figure shows that the temporal patterns for the gaseous components are reproducible between years. For the particulate components, the temporal patterns are also similar between years. One notable exception remains the large peak in aerosol nitrate and sulphate in the early spring of 2003.

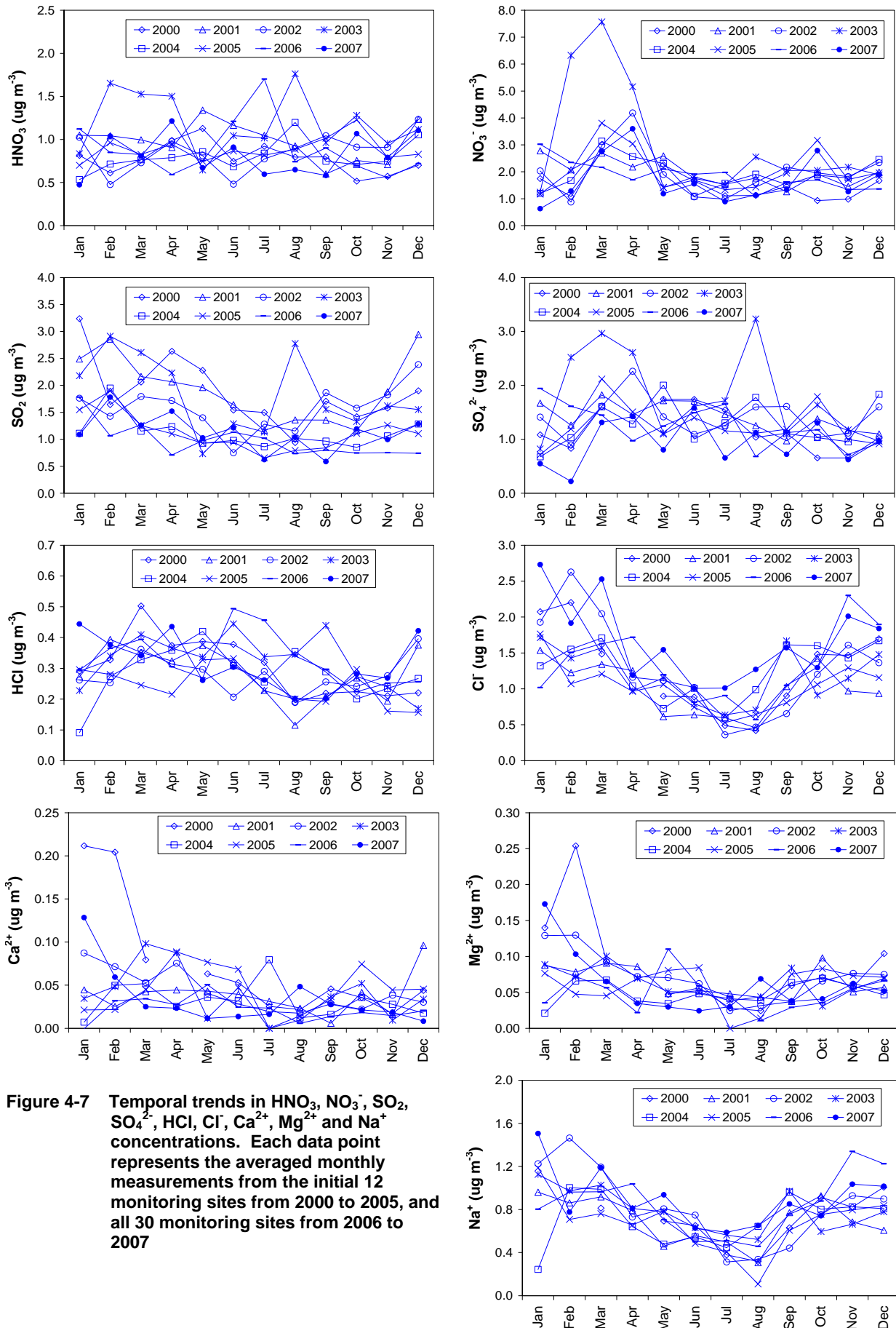
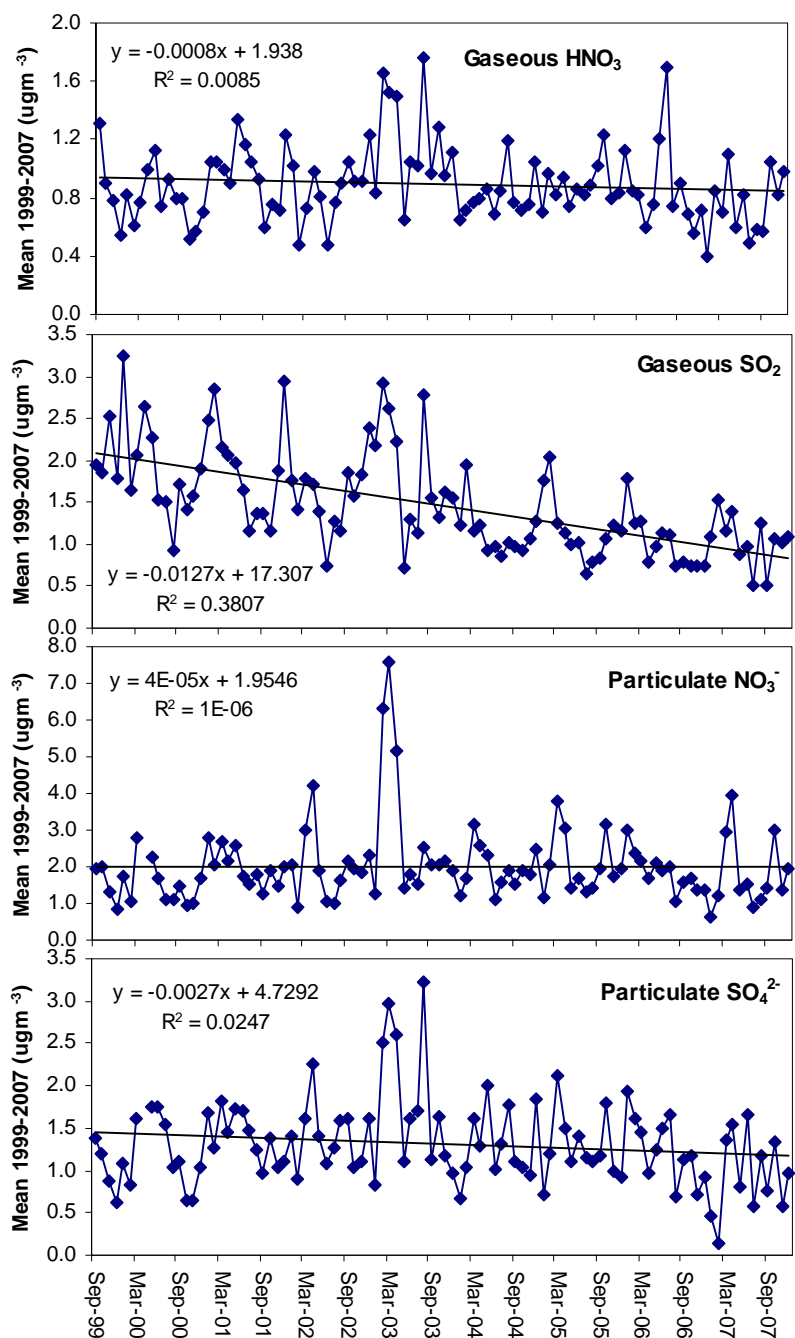

**Figure 4-7** Temporal trends in  $\text{HNO}_3$ ,  $\text{NO}_3^-$ ,  $\text{SO}_2$ ,  $\text{SO}_4^{2-}$ ,  $\text{HCl}$ ,  $\text{Cl}^-$ ,  $\text{Ca}^{2+}$ ,  $\text{Mg}^{2+}$  and  $\text{Na}^+$  concentrations. Each data point represents the averaged monthly measurements from the initial 12 monitoring sites from 2000 to 2005, and all 30 monitoring sites from 2006 to 2007

**Long Term Trends**

Long-term trends in gaseous  $\text{HNO}_3$ ,  $\text{SO}_2$  and particulate  $\text{NO}_3^-$ ,  $\text{SO}_4^{2-}$  are shown in Figure 4-8, by plotting monthly averages of measurement data from the original 12 sites for the period 1999-2007 (insufficient data from new sites for trend analysis). The overall dataset shows no detectable trend in gaseous  $\text{HNO}_3$  or particulate  $\text{NO}_3^-$ , indicating that a longer measurement period may be needed before trends can be detected. Gaseous  $\text{SO}_2$  concentrations however continue to show a gradual downward trend, in agreement with national data from the previous Rural  $\text{SO}_2$  monitoring programme and with UK  $\text{SO}_2$  emissions trends. The average concentration of  $\text{SO}_2$  measured by the nitric acid monitoring network decreased by a factor of nearly 2 over the measurement period, from an annual mean of  $1.9 \mu\text{g SO}_2 \text{ m}^{-3}$  in 2000 to  $1.0 \mu\text{g SO}_2 \text{ m}^{-3}$  in 2007. The decrease in gaseous  $\text{SO}_2$  concentrations is not accompanied by a reduction in DELTA-measured particulate  $\text{SO}_4^{2-}$  concentrations, which remained constant over the same period.

**Figure 4-8 Long-Term trend in gaseous  $\text{HNO}_3$ ,  $\text{SO}_2$  and particulate  $\text{NO}_3^-$ ,  $\text{SO}_4^{2-}$  concentrations (each data point represents the averaged monthly measurements from the original 12 monitoring sites in the network).**



#### 4.3.4 Concentration Maps for 2007

Interpolated concentration fields for 2007 across the UK from the 30 monitoring sites are shown in Figure 4-9. A bilinear interpolation procedure was used to provide the mean concentration field at a grid resolution of 10 km x 10 km. The spatial distributions of  $\text{HNO}_3$  and  $\text{NO}_3^-$  are seen to be rather different to that of  $\text{HCl}$  and  $\text{Cl}^-$ . Both the nitrogen species are largest in central and southeast England, with the lowest concentrations of  $\text{HNO}_3$  in Scotland and Northern Ireland. Atmospheric  $\text{HNO}_3$  is expected to be more spatially variable than  $\text{NO}_3^-$  aerosol, reflecting the long atmospheric residence time of the latter. The increase in the number of sites in the network to improve on the spatial concentration field does appear to confirm the higher spatial variability in gaseous  $\text{HNO}_3$ .

The UK Rural  $\text{SO}_2$  Monitoring Network<sup>6</sup>, previously dedicated to the measurement of  $\text{SO}_2$  concentrations, was terminated at the end of 2005, as future measurements would be available from the expanded Nitric Acid monitoring network. The largest annual mean  $\text{SO}_2$  concentrations derived from the DELTA measurements occurred at Sutton Bonington, London Cromwell Road and Detling, with annual mean concentrations of 2.4, 2.3 and 2.7  $\mu\text{g SO}_2 \text{ m}^{-3}$  respectively.  $\text{SO}_2$  concentrations generally decreased towards the west and north of the UK, with the lowest concentrations of  $< 0.5 \mu\text{g SO}_2 \text{ m}^{-3}$  in northern Scotland.  $\text{SO}_2$  is seen to be more spatially variable than  $\text{SO}_4^{2-}$  aerosol, reflecting the long atmospheric residence time of the latter.

Figure 4-9 shows that  $\text{HCl}$  and  $\text{Cl}^-$  concentrations are the largest in the south east and south west of England (Barcombe Mills, Yarner Wood) and lowest in the west of the country (Lough Navar, Eskdalemuir and Cwmystwyth) and most of Scotland (with the exception of Shetland). The distribution may reflect the dual contribution of anthropogenic and marine sources to atmospheric  $\text{Cl}^-$ . The high  $\text{HCl}$  concentrations in the south may be derived from emissions or reaction with  $\text{HNO}_3$  to produce  $\text{HCl}$ . In contrast, the larger  $\text{Cl}^-$  concentration in the southwest is likely to reflect a marine contribution to the aerosol.

The concentration of base cations varies greatly depending on the species. The concentration map for  $\text{Na}^+$  is similar to  $\text{Cl}^-$ , showing the close coupling between the two species.

---

<sup>6</sup> Part of Defra's *Acid Deposition Processes in the UK* contracts: most recently EPG 1/3/166 and RMP 2125

**Figure 4-9 Spatial patterns of HNO<sub>3</sub>, SO<sub>2</sub>, HCl and of aerosols NO<sub>3</sub><sup>-</sup>, SO<sub>4</sub><sup>2-</sup>, Cl<sup>-</sup>, Ca<sup>2+</sup>, Mg<sup>2+</sup> and Na<sup>+</sup> concentrations in the UK from averaged monthly measurements made in 2007**

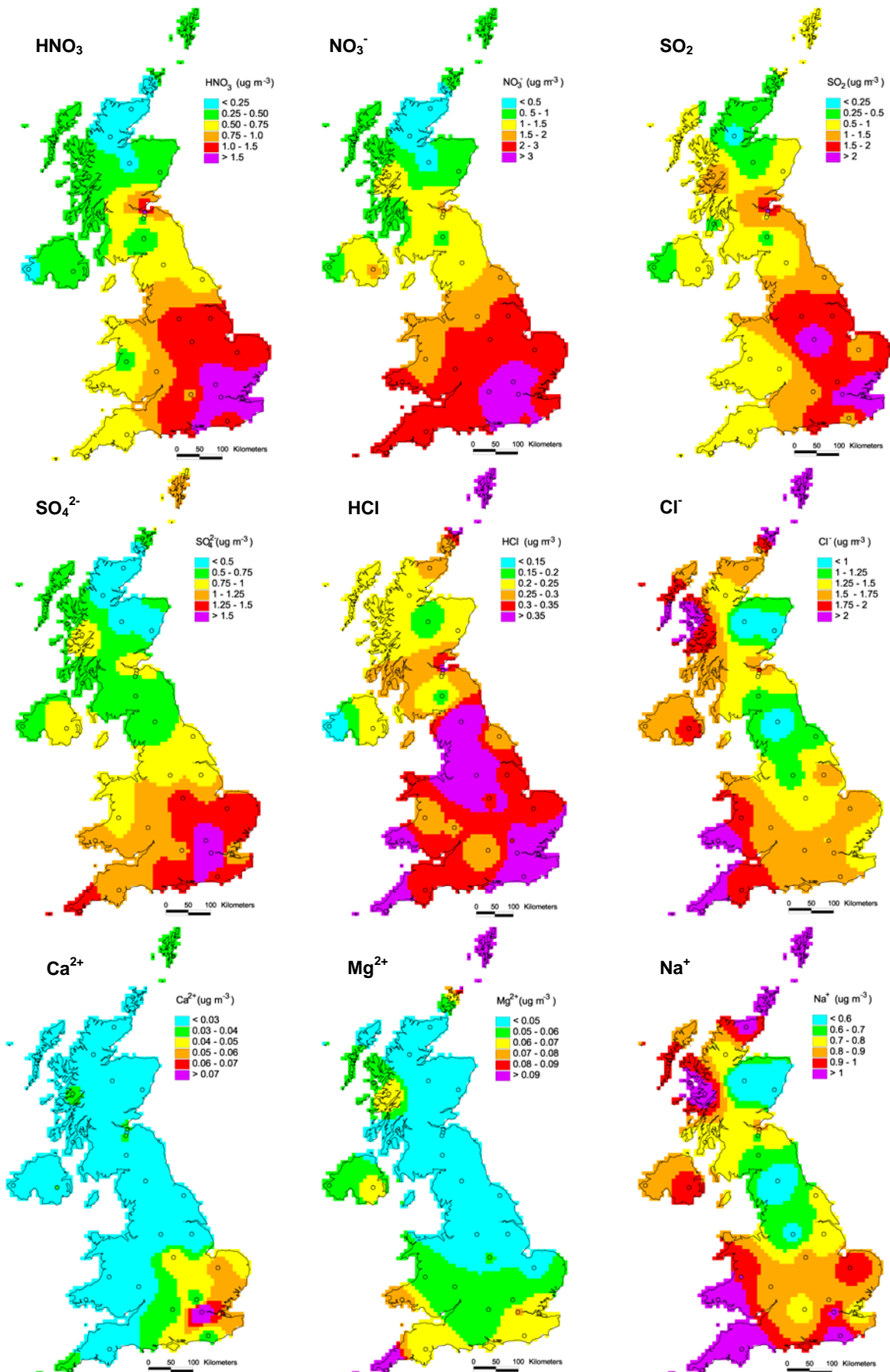

## 4.4 Discussion

Monthly values from the expanded 30 site network have provided an improved spatial concentration field across the UK (see comparisons made in Figure 4-10 below). The main features of the spatial distribution in the pollutants measured are shown in the annual maps (Figure 4-9). In general, there is a reasonable correlation between the concentrations of the different pollutants at the 30 monthly monitoring sites, and for some species there are very high spatial correlations. In the case of the gases, this can be attributed to the regional distribution of sources being similar, meanwhile for the aerosol the chemistry must obviously balance between the major cations and anions.

Figure 4-6 shows that there is, in general, a low correlation between concentrations of gaseous NH<sub>3</sub> and those of SO<sub>2</sub> and HNO<sub>3</sub>; this may be attributed to the different sources of these pollutants, with NH<sub>3</sub> derived predominantly from agricultural sources and SO<sub>2</sub> and HNO<sub>3</sub> from combustion sources.

**Figure 4-10 Comparing HNO<sub>3</sub> and SO<sub>2</sub> concentration maps produced from the new expanded 30 site network with the maps produced using only data from the original 12 sites.**

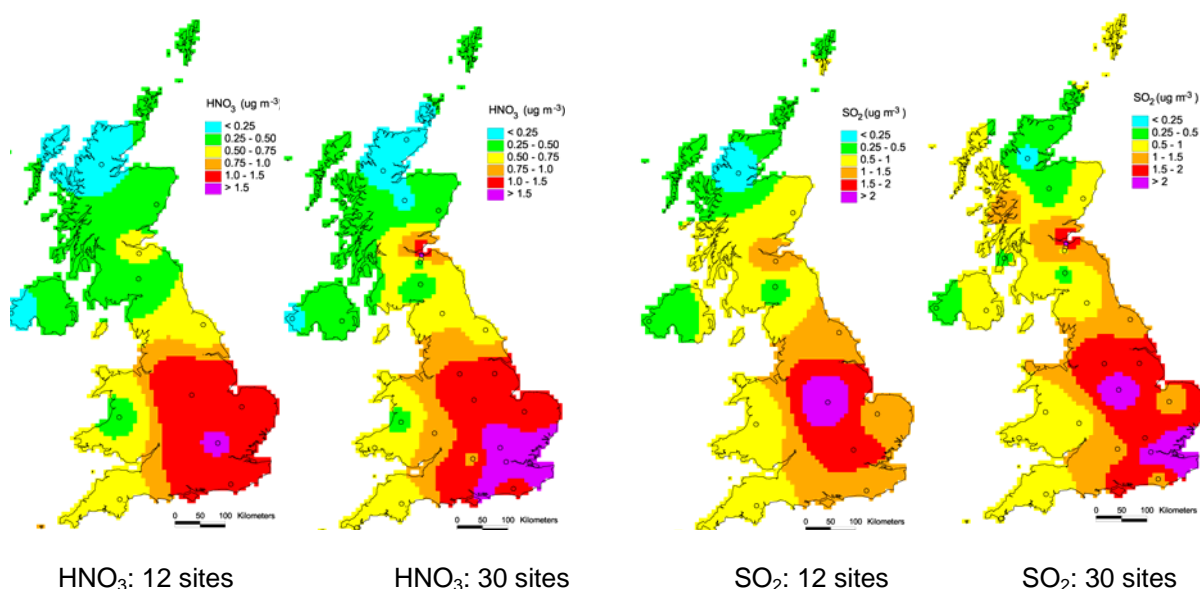

It should be noted that the maps of the acid gas and aerosol concentrations shown in Figure 4-9 are constructed using bi-linear interpolation. With an increase in the number of sites from 12 to 30, there may now be a sufficient number to permit more sophisticated interpolation methods (e.g. kriging), which would provide an estimate of uncertainty in the interpolation. It is clear, however, from the maps that each part of the country is fully dependent on only one point in the interpolation and that, whilst there is a high correlation between the pollutants measured at the sites, there are major differences in concentrations between all adjacent sites. The increase in density of the network thus would allow interpolation uncertainties to be quantified, and could also be expected to change the estimates of regional dry deposition budgets.

The UK deposition budgets for HNO<sub>3</sub>, using interpolated concentrations from the 12 sites in the monitoring network for 2000-2006 are shown in Table 4-2 below.

Year	2000	2001	2002	2003	2004	2005	2006
Annual deposition Budgets for HNO <sub>3</sub> (ktN)	57	73	62	87	57	63	61



The variation between years is due to the inter-annual variability in  $\text{HNO}_3$  concentrations. For 2006, interpolated concentrations from the new expanded 30 site network were used to provide the improved UK deposition budgets for  $\text{HNO}_3$ . Moving from 12 to 30 sites has not greatly altered the UK budget, as the estimate for 2006 was 61 kt N from the new 30 sites network, which is similar to the 2005 estimate of 63 kt N. However, as already demonstrated by the measurements from 12 sites previously, the difference in deposition estimates between years is due to inter-annual variability in  $\text{HNO}_3$  concentrations.

The monthly site data provide information on the overall seasonal behaviour of the different pollutants and inter-annual trends. Figure 4-4 illustrates the monthly changes at each site, and after 8 full years of monitoring, the seasonal trends are distinctive and replicated for each site. Figure 4-7 shows the average seasonal changes for 2000 to 2007 and indicates more clearly the main differences for the pollutants.  $\text{HNO}_3$ ,  $\text{HCl}$  and  $\text{NO}_3^-$  have a maximum during late spring and early summer, which may reflect the importance of photochemical production processes. Conversely,  $\text{SO}_2$ ,  $\text{Na}^+$  and  $\text{Cl}^-$  have maxima during winter, reflecting the importance of combustion processes for  $\text{SO}_2$  and marine sources in winter for sea salt. The reasons for the observed seasonal trends in  $\text{SO}_4^{2-}$ ,  $\text{Mg}^{2+}$  and  $\text{Ca}^{2+}$  are less clear.

## 5 Other Activities

### 5.1 EMEP Intercomparison

#### 5.1.1 Results of the 25<sup>th</sup> EMEP Intercomparison

An important data quality assessment is organised annually by the EMEP Chemical Co-ordinating Centre (CCC) at the Norwegian Institute for Air Research (NILU). Each July, samples are sent to approximately 36 analytical laboratories in Europe, and approximately 25 additional internationally recognised analytical laboratories. The intercomparison exercise is required as part of the EMEP monitoring programme – such a fundamental check on analytical performance is essential if response to emission reductions can be observed consistently throughout Europe. 2007 was the 25<sup>th</sup> time such an intercomparison took place, in which Harwell Scientifics again participated. The samples provided by the CCC included nitrogen dioxide in absorbing solution and synthetic rainwater samples. The results were submitted to the CCC in October 2007, with the expected results provided in January 2008.

A series of method improvements were identified as a result of the 23<sup>rd</sup> intercomparison. These included:

- 1) Introduction of a limit of quantification solution (LOQ) to ensure that the instrument sensitivity criteria are met;
- 2) Expansion of the range of data recorded in the column efficiency logs to improve the way instrument performance is monitored;
- 3) Increasing the coefficient of determination ( $R^2$ ) for the calibration from 0.99 to at least 0.999. The calibration of the ion chromatography instrument uses a parabolic regression analysis. This method of calibration allowed the lowest calibrating standard to have a disproportionately large influence on the calibration- particularly at low concentration levels. The previous  $R^2$  value of 0.99 was too lax to ensure a sufficiently rigorous calibration.

These steps produced a slight improvement in the overall analysis for the 24<sup>th</sup> intercomparison [Lawrence *et al.* 2007]. As analysis of the components of rainwater is UKAS accredited, the method improvements outlined above required an update of Harwell Scientifics' UKAS accreditation.

The 24<sup>th</sup> EMEP Intercomparison identified an issue with the quality of the septa used to seal the top of the sampling vials. Harwell Scientifics now purchase vials with no septa pre-inserted into the vial cap. The septa are now made "in-house" using cleaned aluminum foil. This method, whilst being more time consuming, results in a higher certainty that the septa are not contaminated and also overcomes the issue of the septa breaking up. Since switching to foil septa, the reproducibility (precision) of QC data throughout any given analytical run has improved. The number of QC failures for rainwater analyses has also decreased noticeably, likely as a result of injection volumes being more stable (i.e. less fragments of septa in the system).

This improvement is shown in the 25<sup>th</sup> intercomparison, where the variation observed from the 24<sup>th</sup> intercomparison has not been repeated.

Table 5-1 compares the expected and measured concentrations for different components of the rainwater samples. Generally, the agreement for nitrate, ammonia, magnesium, sodium, chloride, potassium and pH is the same or better than that found for the unaffected samples for the 24<sup>th</sup> intercomparison. The agreement for sulphate was not as good as for the 24<sup>th</sup> intercomparison.

<b>Table 5-1 Comparison of Expected and Measured Concentrations of the Major Ions in Synthetic Rainwater</b>				
Species	Sample code	Expected concentration $\mu\text{eq l}^{-1}$	Measured concentration $\mu\text{eq l}^{-1}$	Absolute Mean difference (%)
Sulphate	G1	69.6	65.7	-5.7
	G2	69.9	63.6	-9.4
	G3	44.4	40.2	-9.9
	G4	55.3	49.8	-10.0
Nitrate	G1	21.4	21.5	0.3
	G2	21.0	21.2	1.0
	G3	28.4	28.8	1.2
	G4	40.4	40.2	-0.5
Ammonium	G1	11.5	11.1	-2.8
	G2	9.5	11.0	14.1
	G3	17.2	18.1	5.4
	G4	26.9	28.1	4.2
Magnesium	G1	12.7	12.7	-0.6
	G2	5.5	6.0	8.4
	G3	6.8	6.7	-0.7
	G4	8.5	8.6	1.7
Sodium	G1	9.3	8.2	-11.9
	G2	10.8	10.4	-3.8
	G3	15.4	15.1	-1.8
	G4	20.2	19.4	-3.8
Chloride	G1	3.8	3.6	-6.2
	G2	4.6	4.2	-7.8
	G3	7.6	7.3	-3.9
	G4	9.3	8.7	-6.7
Calcium	G1	0.0	1.7	N/A
	G2	7.6	7.6	-0.8
	G3	8.9	8.1	-9.3
	G4	12.1	11.8	-2.4
Potassium	G1	4.5	4.2	-8.0
	G2	5.2	4.3	-18.0
	G3	3.5	3.4	-1.3
	G4	2.6	2.7	3.0
pH *	G1	4.2	4.3	0.9
	G2	4.2	4.3	0.5
	G3	4.5	4.6	0.6
	G4	4.5	4.5	0.4

\* pH as pH units

Table 5-2 shows the results of the 25<sup>th</sup> EMEP intercomparison for nitrogen dioxide in an absorbing solution. The performance was an improvement over the 24<sup>th</sup> intercomparison results.

<b>Table 5-2 Comparison of Expected and Measured Concentrations of Nitrogen Dioxide in Absorbing Solution</b>			
Sample code	Expected concentration $\mu\text{g NO}_2\text{-N/ml}$	Measured concentration $\mu\text{g NO}_2\text{-N/ml}$	Absolute Mean difference (%)
C1	0.077	0.076	-1.00
C2	0.047	0.044	-6.01
C3	0.100	0.103	2.83
C4	0.107	0.107	0.19

## 5.2 LGC Prepared Samples

As an additional quality assurance measure, 2 artificial rainwater samples were obtained from the Laboratory of the Government Chemist (LGC)<sup>7</sup>. These samples were each divided into 2 equal sub-samples and submitted to Harwell Scientifics Ltd as if they were actual rainwater samples (4 samples were submitted altogether).

The certified concentrations are compared against the concentrations obtained by the analysts in Table 5-3. There was good agreement between the sulphate, higher nitrate concentration, ammonium, sodium and chloride concentrations. The nitrate concentration for Sample 408 was comparable in magnitude to Samples G1 and G2 of the EMEP intercomparison, however the analytical performance of the lower concentration LGC sample was slightly poorer than for the lower concentration EMEP samples.

There was a poorer agreement between the calcium and potassium observed and expected values, with laboratory measurements being greater than the expected values in all cases.

Overall the laboratory performance for the Certified Reference Material provided by LGC was not as good as for the EMEP samples.

AEA will work with Harwell Scientifics Ltd to understand reasons for the discrepancy in performance between the EMEP and LGC samples.

---

<sup>7</sup> These solutions were provided to LGC by the European Commission Joint Research Centre, Institute for Reference Materials and Measurements

<b>Table 5-3 Comparison of Expected LGC values and Measured Concentrations</b>				
Species	Sample code	Expected concentration $\mu\text{eq l}^{-1}$	Measured concentration $\mu\text{eq l}^{-1}$	Mean Difference (%)
Sulphate	408A	21.0	18.9	-10.7
	408B	21.0	19.4	-7.9
	409A	106.4	99.3	-6.9
	409B	106.4	99.0	-7.2
Nitrate	408A	20.1	21.2	5.4
	408B	20.1	26.1	25.9
	409A	78.1	77.3	-1.1
	409B	78.1	77.0	-1.4
Ammonium	408A	21.0	21.7	3.1
	408B	21.0	21.9	4.0
	409A	106.0	111.3	4.9
	409B	106.0	110.6	4.3
Magnesium	408A	12.3	13.8	11.9
	408B	12.3	13.9	12.1
	409A	24.6	26.5	7.5
	409B	24.6	26.1	6.0
Sodium	408A	42.0	44.4	5.6
	408B	42.0	45.3	7.5
	409A	82.9	87.0	4.8
	409B	82.9	85.9	3.6
Chloride	408A	67.3	67.0	-0.5
	408B	67.3	67.6	0.4
	409A	113.0	111.9	-1.0
	409B	113.0	111.6	-1.3
Calcium	408A	15.4	19.4	23.0
	408B	15.4	25.3	48.7
	409A	31.0	36.2	15.5
	409B	31.0	35.0	12.2
Potassium	408A	2.3	2.6	12.9
	408B	2.3	2.9	22.6
	409A	4.3	4.9	14.4
	409B	4.3	4.9	13.3
pH *	408A	4.8	5.0	4.5
	408B	4.8	4.7	-1.7
	409A	4.3	4.4	1.9
	409B	4.3	4.7	8.5

\* pH as pH units

## References

- Campbell, G.W., J.R. Stedman, C.E.H. Downing, K. Vincent, S.E. Hasler and M. Davies (1994): **Acid Deposition in the United Kingdom: Data Report 1993**, Report AEA/CS/16419029/001, AEA Technology, Culham, Oxon. OX14 3ED
- Campbell, G.W., K. Vincent, C. Downing, S. Hasler, B. Donovan, M. Smith, L. Sansom and H. Page (1998): **Acid Deposition Monitoring in the UK: 1986 to 1997**, Report (AEAT-3716/20137001 Issue 1) prepared for the Department of the Environment, Transport and the Regions under contract EPG 1/3/54, AEA Technology, Culham, Oxon. OX14 3ED
- Dore, C.J., J.D. Watterson, T.P. Murrells, N.R. Passant, M.M. Hobson, S.L. Baggott, G. Thistlethwaite et al (2006): **Emissions of Air Pollutants 1970-2004**, 18<sup>th</sup> annual report from the UK National Atmospheric Emissions Inventory (NAEI), Report AEA/R/2359, AEA Technology plc, Gemini Building, Harwell, Didcot OX11 0QR
- Hall, D.J. (1986): **The Precipitation Collector for Use in the Secondary National Acid Deposition Network**, Warren Spring Laboratory, LR 561 (AP), Available from AEA Technology, Culham, Oxon. OX14 3ED
- Hayman, G.D., K. Vincent, S. Hasler, S. Baker, B. Donovan, M. Smith, L. Sansom and H. Page (2000): **Acid Deposition Monitoring in the UK: 1986 to 1998**, AEA Technology Report AEAT/EEQC-0143, AEA Technology plc, E5 Culham, Abingdon, OX14 3ED
- Hayman, G.D., S. Hasler, S. Baker, M. Smith, M. Davies, J.R. Stedman, L. Sansom and H. Page (2001a): **Rural Sulphur Dioxide Monitoring in the UK: 1998**, AEA Technology Report AEAT/R/ENV/0378 Issue 2, prepared on the contract TO 7078D1/Acid Deposition Processes (EPG 1/3/94), AEA Technology plc, E5 Culham, Abingdon, OX14 3ED
- Hayman, G.D., S. Hasler, S. Baker, M. Smith, M. Davies, J.R. Stedman, R. Storeton-West, D. Fowler, K. Hargreaves, Y.S. Tang, L. Sansom and H. Page (2001b): **Rural Sulphur Dioxide Monitoring in the UK: 1999**, AEA Technology Report AEAT/ENV/R/0463 Issue 1, prepared on the contract TO 7078D1/Acid Deposition Processes (EPG 1/3/94), AEA Technology plc, E5 Culham, Abingdon, OX14 3ED
- Hayman, G.D., K. Vincent, S. Hasler, S. Baker, B. Donovan, M. Smith, M. Sutton, Y.S. Tang, U. Dragosits, L. Love, D. Fowler, L. Sansom and H. Page (2001c): **Acid Deposition Monitoring in the UK: 1986 to 1999**, AEA Technology Report AEAT/ENV/R/0523 Issue 1, AEA Technology plc, E5 Culham, Abingdon, OX14 3ED
- Hayman, G.D., S. Hasler, K. Vincent, H. Lawrence, M. Smith, M. Davies, M. Sutton, Y.S. Tang, U. Dragosits, L. Love, D. Fowler, L. Sansom and H. Page (2001d): **Operation and Management of the UK Acid Deposition Monitoring Networks: Data Summary for 2000**, AEA Technology Report AEAT/ENV/R/0740 Issue 1, AEA Technology plc, E5 Culham, Abingdon, OX14 3ED
- Hayman, G.D., S. Hasler, S. Baker, M. Smith, M. Davies, K. Vincent, J.R. Stedman, L. Sansom and H. Page (2003a): **Rural Sulphur Dioxide Monitoring in the UK: 2000**, AEA Technology Report AEAT/R/ENV/0619 Issue 1, prepared on the contract F3CR05-D4-117-01/Acid Deposition Processes (EPG 1/3/166), AEA Technology plc, E5 Culham, Abingdon, OX14 3ED
- Hayman, G.D., S. Hasler, K. Vincent, H. Lawrence, M. Smith, M. Davies, M. Sutton, Y.S. Tang, U. Dragosits, L. Love, D. Fowler, L. Sansom and H. Page (2003b): **Operation and Management of the UK Acid Deposition Monitoring Networks: Data Summary for 2001**, AEA Technology Report AEAT/ENV/R/1343 Issue 1, AEA Technology plc, E5 Culham, Abingdon, OX14 3ED
- Hayman, G.D., S. Hasler, K. Vincent, H. Lawrence, M. Smith, M. Davies, M. Sutton, Y.S. Tang, U. Dragosits, L. Love, D. Fowler, L. Sansom and H. Page (2004): **Operation and Management of the UK Acid Deposition Monitoring Networks: Data Summary for 2002**, AEA Technology Report AEAT/ENV/R/1696 Issue 1, AEA Technology plc, E5 Culham, Abingdon, OX14 3ED
- Hayman, G.D., K. Vincent, H. Lawrence, M. Smith, M. Davies, M. Sutton, Y.S. Tang, U. Dragosits, L. Love, D. Fowler, L. Sansom and H. Page (2005a): **Operation and Management of the UK Acid Deposition Monitoring Networks: Data Summary for 2003**, AEA Technology Report AEAT/ENV/R/1818 Issue 1, AEA Technology plc, 551 Harwell, Abingdon, OX11 0QJ

- Hayman, G.D., K. Vincent, H. Lawrence, M. Smith, M. Davies, M. Sutton, Y.S. Tang, U. Dragosits, L. Love, D. Fowler, L. Sansom and H. Page (2005b): **Operation and Management of the UK Acid Deposition Monitoring Networks: Data Summary for 2004**, AEA Technology Report AEAT/ENV/R/2093 Issue 1, AEA Technology plc, 551 Harwell, Abingdon, OX11 0QJ
- Hayman, G.D., K. Vincent, H. Lawrence, M. Smith, C. Colbeck, M. Davies, M. Sutton, Y.S. Tang, U. Dragosits, L. Love, D. Fowler, M. Kendall and H. Page (2007a): **Management and Operation of the UK Acid Deposition Monitoring Network: Data Summary for 2005**, AEA Energy & Environment Report AEAT/ENV/R/2342 Issue 1, AEA Technology plc, The Gemini Building, Fermi Avenue, Harwell, OX11 0QR
- Hayman, G.D., H. Lawrence, K. Vincent, M. Smith, M. Davies, C. Colbeck, S. Hasler, S. Baker, J. Stedman, L. Sansom, H. Page and M. Kendall (2007b): **Rural Sulphur Dioxide Monitoring in the UK: Data Summary 2001-2005**, AEA Energy & Environment Report AEAT/ENV/R/2292 Issue 1, AEA Technology plc, The Gemini Building, Fermi Avenue, Harwell, OX11 0QR
- Kent, A.J., S. Grice, J.R. Stedman, T.J. Bush, K.J. Vincent, J. Abbott, R. Derwent, M. Hobson (2006): **UK air quality modelling for annual reporting 2005 on ambient air quality assessment under Council Directives 96/62/EC, 1999/30/EC and 2000/69/EC**, AEA Energy & Environment Report AEAT/ENV/R/2278 Issue 1, AEA Technology plc, The Gemini Building, Fermi Avenue, Harwell, OX11 0QR
- Lawrence, H., K. Vincent, M. Smith, C. Colbeck, Y.S. Tang, M.A. Sutton, I. Simmons, L. Love, E. Vogt, N. van Dijk, J.N. Cape and R. I. Smith (2007): **UK Acid Deposition Monitoring Network: Data Summary 2006**, AEA Energy & Environment Report AEAT/ENV/R/2534 Issue 2, AEA Technology plc, The Gemini Building, Fermi Avenue, Harwell, OX11 0QR
- NEGTA (2001): **Transboundary Air Pollution: Acidification, Eutrophication and Ground-level Ozone in the UK**, Report prepared by the National Expert Group on Transboundary Air Pollution on behalf of the Department for Environment, Food and Rural Affairs and the Devolved Administrations (ISBN 1 870393 61 9)
- RGAR (1990): **Acid Deposition in the United Kingdom 1986-1988**, Third report of the Review Group on Acid Rain prepared for the UK Department of the Environment [ISBN 0-85624 650 6]
- RGAR (1997): **Acid Deposition in the United Kingdom 1992-1994**, The Review Group on Acid Rain, London (DOE Publications Despatch Centre, Blackhorse Road, London, SE99 6TT), ISBN 0-7058-1741-5
- Stedman, J.R. (1997): **Estimated High Resolution Maps of Background Air Pollutant Concentrations in the UK in 1996**, Report AEA/RAMP/20008001/004, AEA Technology, Culham, Oxon. OX14 3ED
- Stone, B.H. and P.J. Tily (1992): **Field Trials of a Re-designed Wet-only Precipitation Collector**, Warren Spring Laboratory, LR 918 (AP), Available from AEA Technology, Culham, Oxon. OX14 3ED
- Vincent K.J., Campbell, G.W., J.R. Stedman, C.E.H. Downing, S.E. Hasler, M. Davies, L.E. Sansom, M.E. Kendall and H.M. Page (1995): **Acid Deposition in the United Kingdom: Wet Deposition 1994**, Report AEA/RAMP/20017001/001, AEA Technology, Culham, Oxon. OX14 3ED
- Vincent K.J. and G.W. Campbell (1996): **Rural Sulphur Dioxide concentrations in the United Kingdom: 1991 to 1995**, Report AEA/RAMP/20088001/1, AEA Technology, Culham, Oxon. OX14 3ED
- Vincent K.J., G.W. Campbell, J.R. Stedman, C.E.H. Downing, S.E. Hasler, M. Davies, L.E. Sansom, C. Briscoombe and H.M. Page (1996): **Acid Deposition Monitoring in the United Kingdom: The First Ten Years**, Report AEA/1825/20017001/Issue 1, AEA Technology, Culham, Oxon. OX14 3ED
- Vincent K.J., C.E.H. Downing, S.E. Hasler, M. Davies, L.E. Sansom, H.M. Page and G.W. Campbell (1998): **Acid Deposition Monitoring in the United Kingdom: 1986 to 1996**, Report AEA/2766/20017201/Issue 1, AEA Technology, Culham, Oxon. OX14 3ED
- Webster, R., G.W. Campbell and J.G. Irwin (1991): **Spatial analysis and mapping the annual mean concentrations of acidity and major ions in precipitation over the United Kingdom in 1986**, Environ. Monitor. Assess., 16,1-17, 1991

## Acknowledgements

This work was funded by the UK Department for Environment, Food and Rural Affairs (Defra) and the Devolved Administrations – the Scottish Government, the Welsh Assembly Government and the Department of Environment Northern Ireland, under the contract: *The UK Acid Deposition Monitoring Network* (RMP 2901).

Special thanks are due to the local site operators, all of whom have conscientiously serviced the sampling equipment regardless of weather conditions. Their commitment to the network has helped provide such a comprehensive and high quality data set.

We are grateful for the expertise of Anthony Cossburn, Elina Armas-Sanchez, Marketa Dina, Mark Heaps and Heather Page of Harwell Scientifics Ltd, for their capability and quick response to any queries.

Thanks are due to Malcolm Smith, the AEA network manager until July 2008, and to Martin Davies for their combined work in the network management role.

The Nitric Acid Monitoring programme, operated and managed by the Centre for Ecology and Hydrology (CEH), Edinburgh, was funded under this contract together with supporting funds from NERC and the Defra-funded UK National Ammonia Monitoring Network. CEH are grateful to the site operators at the monitoring sites for their contributions, and other colleagues at CEH who assisted in the project.



## Appendices

- Appendix 1: Bulk Precipitation Data 2007
- Appendix 2: Tables of Mean Concentration and Total Rainfall  
1986 – 2007
- Appendix 3: Concentration Data for Particulate Sulphate 2007
- Appendix 4: Concentration Data for Nitrogen Dioxide 2007
- Appendix 5: Nitric Acid Denuder Measurements 2007
- Appendix 6: Geostatistics



# Appendix 1

## Bulk Precipitation Data 2007 – Fortnightly Measurements

### Notes to Appendix 1.1

There are two pages of information for each site. The first includes site characteristics, time and seasonal trends; the second page presents individual concentrations for all samples collected (including those samples contaminated with bird strike). Also included are the Ordnance Survey co-ordinates, latitude and longitude and altitude of the site and the average rainfall for the 5 x 5 km square containing the site for the years 1941 to 1970.

Abbreviations for monitoring equipment, which also includes co-located sampling instrumentation, are given below:

- WOC Wet-only collector for daily measurement of rainfall composition
- DT Monthly diffusion tube measurement for nitrogen dioxide
- Daily SO<sub>2</sub> Daily measurements of SO<sub>2</sub> by hydrogen peroxide bubbler and of particulate sulphate on a Whatman 40 filter with ion chromatographic analysis
- Weekly SO<sub>2</sub> Weekly measurements of SO<sub>2</sub> by hydrogen peroxide bubbler with ion chromatographic analysis
- Ozone Hourly measurements surface ozone
- SO<sub>2</sub> Hourly measurements of SO<sub>2</sub>
- NO<sub>x</sub> Hourly measurements of NO<sub>x</sub>
- HNO<sub>3</sub> Denuder Monthly measurements of nitric acid, sulphur dioxide, hydrogen chloride and acid and base aerosol components using the CEH DELTA samplers
- Met Meteorological measurements
- UKAWMN Catchment monitored by the UK Acid Waters Monitoring Network
- EMEP Daily data from this site are made available to EMEP

In the tables of data, a '-' indicates a missing value. A dry week is indicated by a complete row of '-'. Some weeks only have rainfall volumes reported; this is because no analyses were carried out on very low volume rainfall samples or on samples that were visibly contaminated. Individual ion concentrations or conductivities are missing for some low volume weeks, due to there being insufficient sample for complete analysis. A '< Value' indicates that the concentration was less than the detection limit of the analysis. Annual precipitation-weighted mean concentrations and rainfall total are included at the bottom of the table.

A phosphate concentration was also determined for each rainwater sample. A phosphate concentration > 0.1 mg P l<sup>-1</sup> (or > 9.7 µeq l<sup>-1</sup>) was taken as evidence of contamination by birds. Although all these samples have been included in the tables, they were not included in the calculation of annual means. The rainfall totals presented in Appendix 2, Table 10 include all samples collected and are therefore sometimes higher than the totals presented in this section.

# Goonhilly

2007

Site Code: 5003  
 Easting: 1723  
 Northing: 214  
 Latitude: 50 02 54 N  
 Longitude: 05 10 52 W  
 Altitude (m): 108  
 Rainfall (mm): 973  
 [30 year mean 1940 - 1971]

Site Environment:  
 Open moorland, Satellite tracking station

Other measurements:  
 DT, HNO3 Denuder

Site Operator:  
 BT

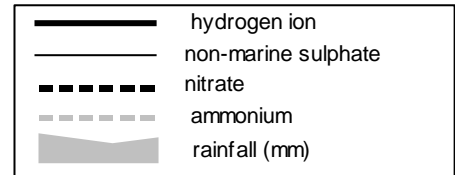
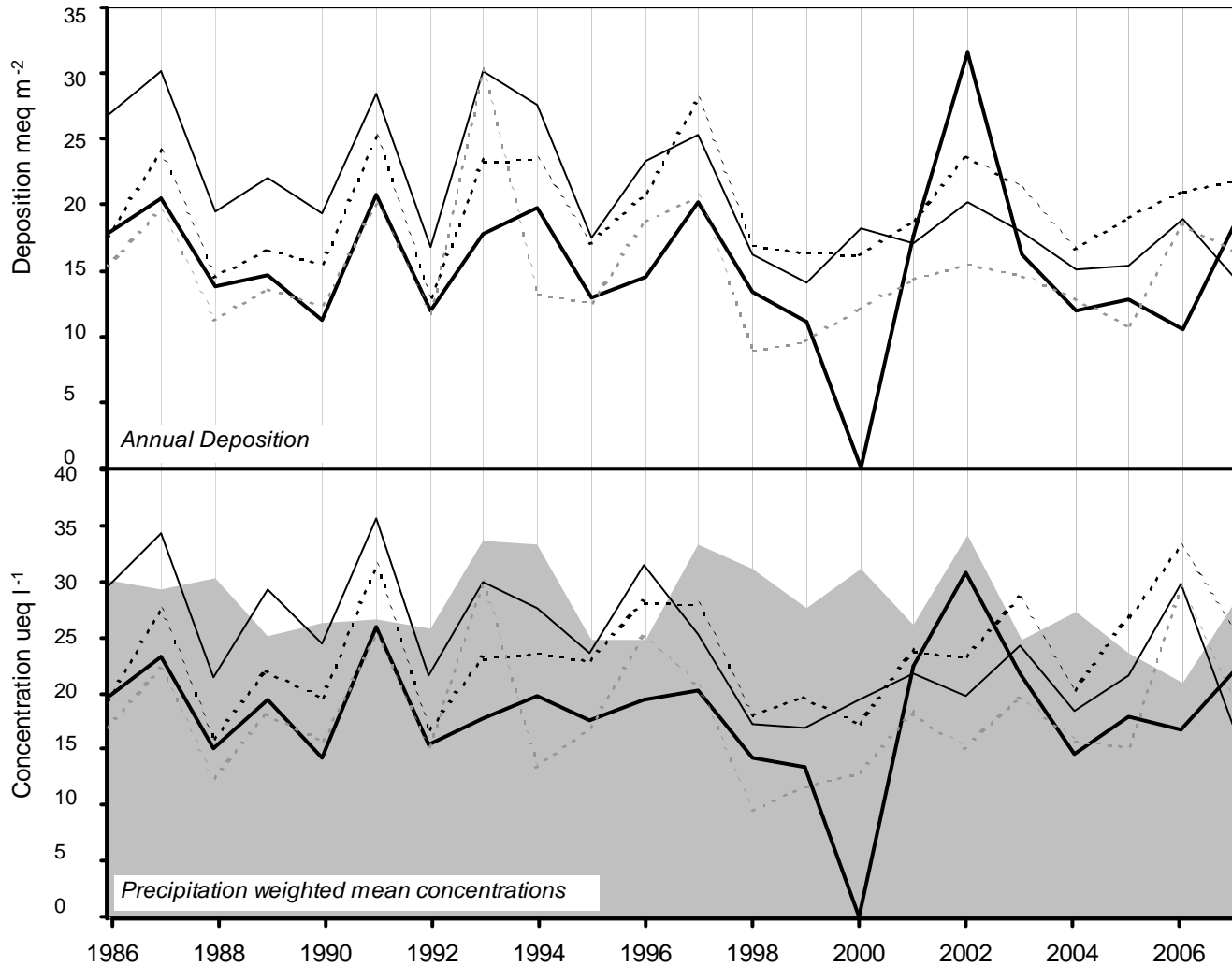

long-term trends in concentration (+x = increase; -x = decrease)	
<i>hydrogen ion</i>	-0.02 ueq/l (-0.12 %/year): 21 years' data - No significant trend detected
<i>non-marine sulphate</i>	-0.47 ueq/l (-1.59 %/year): 22 years' data + Significant trend detected
<i>nitrate</i>	0.33 ueq/l (1.62 %/year): 22 years' data - No significant trend detected
<i>ammonium</i>	0.14 ueq/l (0.84 %/year): 22 years' data - No significant trend detected

(5003) Goonhilly

Start Date	End Date	pH	SO4 (µeq/l)	NO3 (µeq/l)	NH4 (µeq/l)	Na (µeq/l)	Mg (µeq/l)	Ca (µeq/l)	Cl (µeq/l)	K (µeq/l)	PO4 (µeq/l)	nss (µeq/l)	H+ (µeq/l)	Conductivity (S/cm)	Rainfall (mm)
10/Jan/2007	24/Jan/2007	5.2	14.4	3.0	5.5	199.1	38.9	11.7	116.7	2.9	1.5	0.0	6.9	61.8	8.3
24/Jan/2007	08/Feb/2007	4.0	70.0	123.6	78.8	194.7	44.0	14.9	219.8	5.4	<1.0	46.6	109.6	81.6	38.0
08/Feb/2007	21/Feb/2007	4.7	50.4	8.2	15.1	378.7	81.0	18.4	392.6	8.4	<1.0	4.8	19.5	60.8	108.4
21/Feb/2007	08/Mar/2007	5.4	55.4	9.4	23.0	426.9	88.3	20.2	464.4	11.3	6.3	4.0	3.7	66.1	90.7
08/Mar/2007	21/Mar/2007	6.8	90.5	20.2	127.3	663.7	96.6	29.8	735.4	24.3	10.6	10.5	0.2	115.3	8.4
21/Mar/2007	05/Apr/2007	-	-	-	-	-	-	-	-	-	-	-	-	-	0.0
05/Apr/2007	23/Apr/2007	4.7	125.0	240.0	185.9	151.0	42.6	108.4	126.4	9.0	<1.0	106.8	20.0	-	7.7
23/Apr/2007	07/May/2007	4.6	68.3	89.1	63.0	178.9	41.7	37.1	179.7	5.5	<1.0	46.8	27.5	47.9	25.9
07/May/2007	18/May/2007	4.7	38.8	8.4	12.1	211.7	44.6	14.1	196.6	5.0	<1.0	13.3	22.4	35.5	63.8
18/May/2007	04/Jun/2007	4.6	65.3	23.6	9.7	347.4	75.5	24.6	368.5	8.1	<1.0	23.4	24.0	62.7	27.4
04/Jun/2007	15/Jun/2007	4.5	46.3	38.6	27.3	68.4	15.1	17.4	61.0	3.9	<1.0	38.0	30.2	26.3	8.2
15/Jun/2007	02/Jul/2007	4.6	39.6	14.6	7.7	151.7	32.0	8.9	188.9	2.7	<1.0	21.3	26.9	33.0	114.6
02/Jul/2007	26/Jul/2007	4.7	34.3	10.5	3.5	180.2	35.0	11.3	184.8	4.2	<1.0	12.6	19.5	33.0	83.4
26/Jul/2007	09/Aug/2007	4.4	38.0	27.0	0.9	174.5	38.4	15.4	183.8	4.6	<1.0	17.0	41.7	35.2	15.7
09/Aug/2007	28/Aug/2007	4.5	28.5	8.1	3.6	179.2	38.6	11.5	206.0	4.1	<1.0	6.9	34.7	23.4	38.3
28/Aug/2007	11/Sep/2007	-	-	-	-	-	-	-	-	-	-	-	-	-	0.0
11/Sep/2007	19/Sep/2007	-	-	-	-	-	-	-	-	-	-	-	-	-	0.0
19/Sep/2007	03/Oct/2007	5.4	52.1	33.7	27.3	307.5	67.4	40.0	325.7	10.1	<1.0	15.0	3.8	55.5	20.2
03/Oct/2007	17/Oct/2007	4.6	47.2	65.6	38.4	138.8	30.2	14.0	122.1	4.3	<1.0	30.5	24.5	33.6	19.3
17/Oct/2007	16/Nov/2007	5.0	80.6	84.5	52.3	362.5	81.4	33.7	361.3	8.0	3.0	37.0	10.0	-	15.3
16/Nov/2007	29/Nov/2007	4.9	28.6	17.0	13.8	171.6	35.3	12.0	181.4	3.8	<1.0	7.9	12.9	27.0	31.8
29/Nov/2007	12/Dec/2007	5.5	110.7	3.5	<0.7	958.7	217.2	49.1	1021.8	19.2	1.4	0.0	3.4	130.8	81.5
12/Dec/2007	11/Jan/2008	4.8	86.6	44.0	25.3	656.8	143.4	39.3	697.2	13.6	<1.0	7.5	15.5	102.9	49.9
5003		Precipitation<weighted annual means for site(samples containing phosphate are excluded)													Total rainfall
		55.6	25.5	19.2	343.0	74.3	21.9	364.1	7.8	1.2	16.6	22.1		856.7	

# Yarner Wood

2007

Site Code: 5008  
 Easting: 2786  
 Northing: 789  
 Latitude: 50 35 48 N  
 Longitude: 03 42 56 W  
 Altitude (m): 119  
 Rainfall (mm): 1377  
 [30 year mean 1940 - 1971]

Site Environment:  
 Open moorland, nature reserve

Other measurements:  
 DT (triplicate), Daily SO<sub>4</sub>, HNO<sub>3</sub> Denuder, ozone, EMEP

Site Operator:  
 Natural England

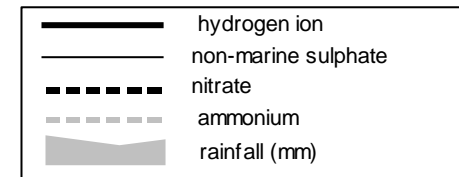
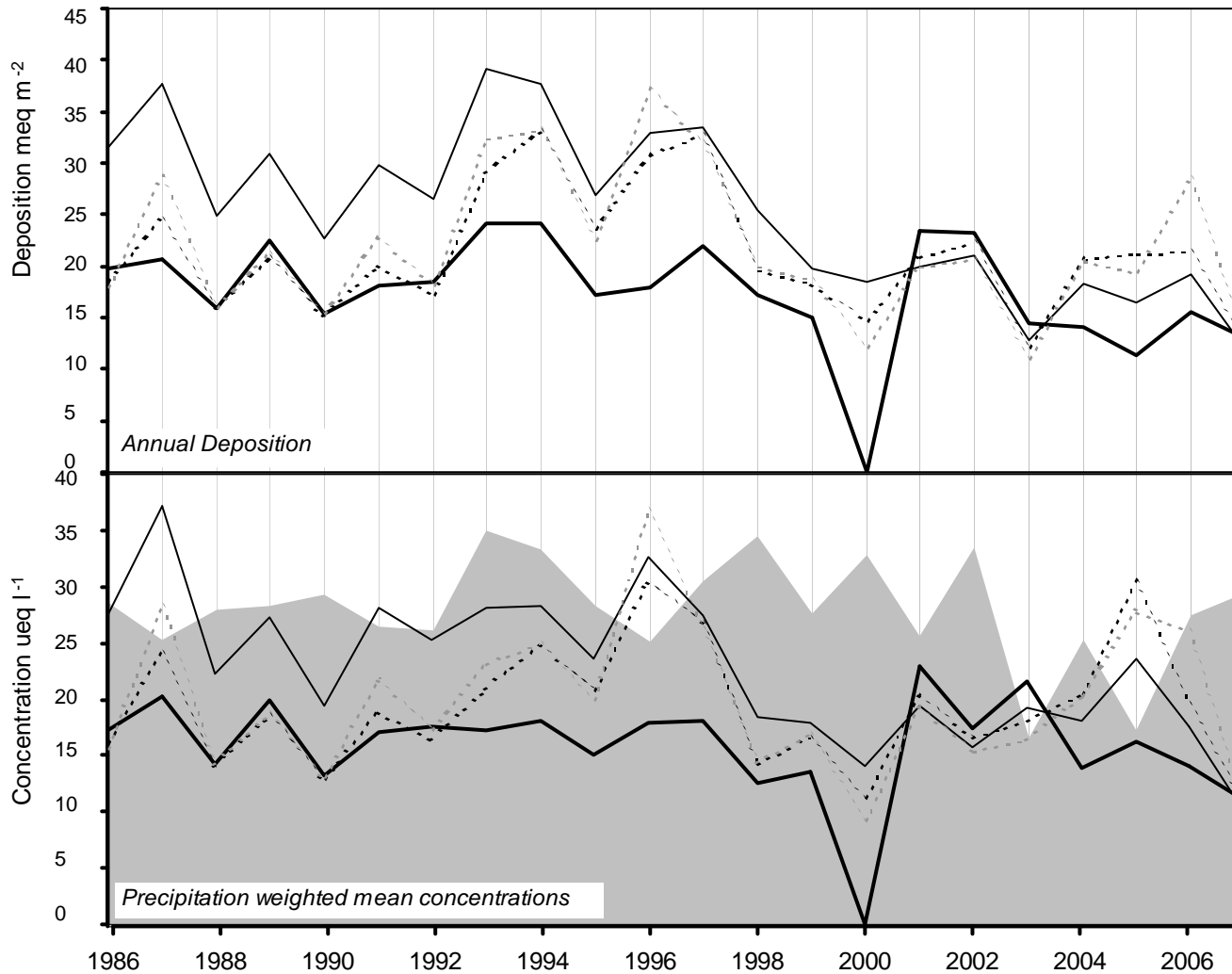

long-term trends in concentration (+x = increase; -x = decrease)	
<i>hydrogen ion</i>	-0.07 ueq/l (-0.39 %/year): 21 years' data - No significant trend detected
<i>non-marine sulphate</i>	-0.67 ueq/l (-2.26 %/year): 22 years' data ++ Moderately strong trend detected
<i>nitrate</i>	0.14 ueq/l (0.79 %/year): 22 years' data - No significant trend detected
<i>ammonium</i>	0.16 ueq/l (0.83 %/year): 22 years' data - No significant trend detected

(5008) Yarner Wood

Start Date	End Date	pH	SO4 (µeq/l)	NO3 (µeq/l)	NH4 (µeq/l)	Na (µeq/l)	Mg (µeq/l)	Ca (µeq/l)	Cl (µeq/l)	K (µeq/l)	PO4 (µeq/l)	Nss SO4 (µeq/l)	H+ (µeq/l)	Conductivity (S/cm)	Rainfall (mm)
10/Jan/2007	24/Jan/2007	5.2	25.2	3.9	<0.7	187.6	36.7	9.7	195.1	3.0	<1.0	2.6	5.9	27.3	78.9
24/Jan/2007	07/Feb/2007	-	-	-	-	-	-	-	-	-	-	-	-	-	0.0
07/Feb/2007	21/Feb/2007	4.8	30.9	15.3	20.0	164.0	32.5	9.3	176.3	3.6	<1.0	11.2	15.8	30.9	162.6
21/Feb/2007	07/Mar/2007	5.0	23.6	5.7	5.2	143.3	28.8	6.5	161.9	2.2	<1.0	6.3	10.0	23.8	186.6
07/Mar/2007	21/Mar/2007	-	-	-	-	-	-	-	-	-	-	-	-	-	0.0
21/Mar/2007	04/Apr/2007	-	-	-	-	-	-	-	-	-	-	-	-	-	0.0
04/Apr/2007	18/Apr/2007	-	-	-	-	-	-	-	-	-	-	-	-	-	0.0
18/Apr/2007	02/May/2007	4.7	462.2	111.3	1867.6	110.7	28.7	36.4	157.5	252.1	812.7	448.9	20.0	-	3.7
02/May/2007	16/May/2007	5.3	21.8	18.6	27.8	26.2	6.0	12.3	22.0	2.3	<1.0	18.7	4.9	10.0	72.6
16/May/2007	29/May/2007	5.5	17.7	9.5	8.8	63.7	8.2	5.8	58.6	3.3	<1.0	10.0	3.5	12.6	41.8
29/May/2007	12/Jun/2007	7.9	161.2	20.7	1133.2	116.8	21.8	9.4	132.6	122.3	322.6	147.1	0.0	176.8	8.3
12/Jun/2007	26/Jun/2007	6.8	87.2	11.1	867.6	36.5	6.2	2.2	57.9	68.3	200.7	82.8	0.2	94.2	164.3
26/Jun/2007	11/Jul/2007	7.4	105.7	7.5	1248.7	102.8	14.0	3.8	160.0	81.4	186.6	93.3	0.0	165.6	30.1
11/Jul/2007	25/Jul/2007	4.7	24.7	13.9	9.8	39.9	7.3	8.7	35.6	1.0	<1.0	19.9	22.4	14.7	35.3
25/Jul/2007	08/Aug/2007	5.2	14.4	<0.7	2.5	63.1	10.6	7.3	63.4	1.3	<1.0	6.8	5.9	8.6	34.2
08/Aug/2007	22/Aug/2007	5.0	14.9	6.8	5.3	61.3	9.9	13.8	61.6	1.7	<1.0	7.5	9.1	9.1	53.4
22/Aug/2007	05/Sep/2007	-	-	-	-	-	-	-	-	-	-	-	-	-	0.0
05/Sep/2007	19/Sep/2007	-	-	-	-	-	-	-	-	-	-	-	-	-	0.0
19/Sep/2007	03/Oct/2007	6.4	52.3	49.1	118.2	88.8	16.5	8.8	105.7	15.8	23.0	41.6	0.4	32.3	50.5
03/Oct/2007	31/Oct/2007	4.7	28.7	38.3	30.6	35.9	9.4	10.8	31.2	2.8	<1.0	24.4	20.9	15.7	31.7
31/Oct/2007	15/Nov/2007	-	-	-	-	-	-	-	-	-	-	-	-	-	0.0
15/Nov/2007	28/Nov/2007	4.8	13.0	17.1	7.0	37.2	8.0	5.3	38.5	1.2	1.3	8.5	17.8	11.7	50.8
28/Nov/2007	12/Dec/2007	5.2	30.2	3.0	2.9	252.5	53.6	16.0	261.1	5.1	1.3	0.0	5.8	34.5	128.3
12/Dec/2007	26/Dec/2007	4.8	31.7	29.3	18.7	82.5	17.5	23.5	79.7	3.0	1.2	21.7	17.8	29.7	9.4
26/Dec/2007	09/Jan/2008	4.7	42.3	16.3	11.0	284.1	61.1	15.4	308.8	5.7	<1.0	8.1	21.9	49.1	37.6
			Precipitation<weighted annual means for site(samples containing phosphate are excluded)												Total rainfall
5008			25.2	10.6	10.4	137.0	27.6	10.2	145.0	3.0	0.7	10.1	11.0		1180.2

# Barcombe Mills

2007

Site Code: 5007  
 Easting: 5437  
 Northing: 1149  
 Latitude: 50 54 54 N  
 Longitude: 00 02 40 E  
 Altitude (m): 10  
 Rainfall (mm): 876  
 [30 year mean 1940 - 1971]

Site Environment:  
 Water pumping site

Other measurements:  
 DT, Daily SO<sub>4</sub>, HNO<sub>3</sub> Denuder, EMEP

Site Operator:  
 South East Water

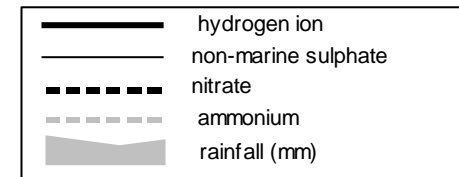
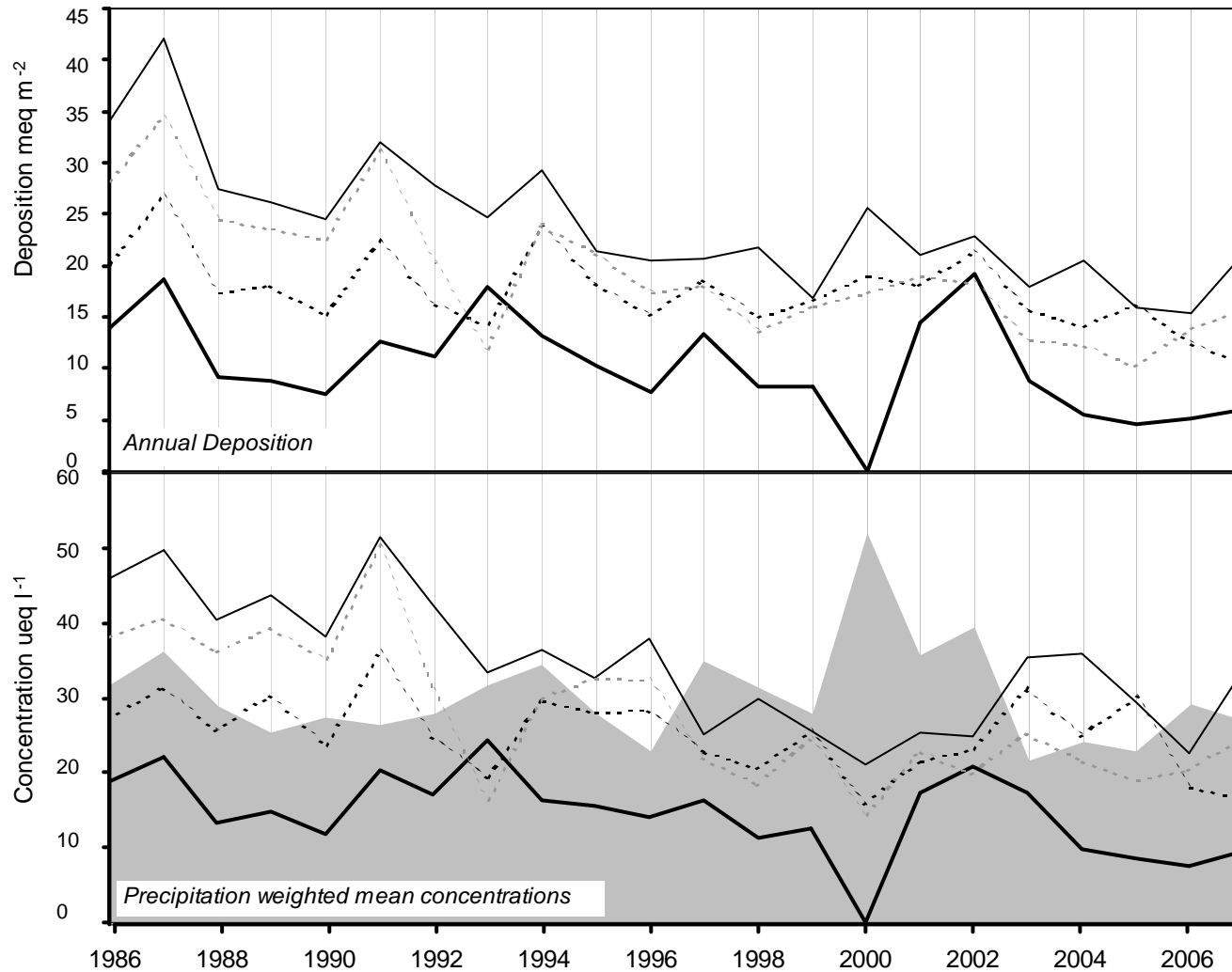

long-term trends in concentration (+x = increase; -x = decrease)	
<i>hydrogen ion</i>	-1.11 ueq/l (-2.82 %/year): 22 years' data +++ Strong trend detected
<i>non-marine sulphate</i>	-0.96 ueq/l (-2.14 %/year): 22 years' data ++ Moderately strong trend detected
<i>nitrate</i>	-0.31 ueq/l (-1.10 %/year): 22 years' data - No significant trend detected
<i>ammonium</i>	-0.42 ueq/l (-2.17 %/year): 21 years' data + Significant trend detected



(5007) Barcombe Mills

Start Date	End Date	pH	SO4 (µeq/l)	NO3 (µeq/l)	NH4 (µeq/l)	Na (µeq/l)	Mg (µeq/l)	Ca (µeq/l)	Cl (µeq/l)	K (µeq/l)	PO4 (µeq/l)	Nss SO4 (µeq/l)	H+ (µeq/l)	Conductivity (S/cm)	Rainfall (mm)
03/Jan/2007	24/Jan/2007	5.0	104.7	10.3	35.5	635.7	140.7	44.3	734.7	23.5	<1.0	28.1	11.2	126.9	39.6
24/Jan/2007	31/Jan/2007	-	-	-	-	-	-	-	-	-	-	-	-	-	0.0
31/Jan/2007	14/Feb/2007	4.7	37.5	22.1	31.3	199.5	43.8	14.5	219.2	4.8	<1.0	13.4	20.4	38.4	38.3
14/Feb/2007	28/Feb/2007	4.7	24.1	14.1	10.9	80.3	15.2	5.6	96.5	2.0	<1.0	14.5	18.6	21.7	53.9
28/Feb/2007	14/Mar/2007	4.8	46.8	9.3	6.6	318.0	72.6	23.8	359.7	7.1	<1.0	8.5	15.8	53.5	44.6
14/Mar/2007	28/Mar/2007	-	-	-	-	-	-	-	-	-	-	-	-	-	0.0
28/Mar/2007	11/Apr/2007	-	-	-	-	-	-	-	-	-	-	-	-	-	0.0
11/Apr/2007	25/Apr/2007	-	-	-	-	-	-	-	-	-	-	-	-	-	0.0
25/Apr/2007	09/May/2007	-	-	-	-	-	-	-	-	-	-	-	-	-	2.6
09/May/2007	23/May/2007	5.7	49.4	8.8	27.1	119.7	22.7	20.9	128.7	21.4	3.6	35.0	1.8	23.9	38.6
23/May/2007	06/Jun/2007	6.9	84.4	39.7	494.5	57.0	6.9	19.0	55.4	58.1	92.5	77.6	0.1	82.8	24.7
06/Jun/2007	20/Jun/2007	5.4	64.9	38.7	40.7	35.0	12.4	31.5	45.4	22.7	1.9	60.7	4.4	20.0	14.9
20/Jun/2007	04/Jul/2007	5.6	37.8	<0.7	8.4	83.7	15.7	11.2	95.7	19.1	<1.0	27.8	2.8	17.9	69.6
04/Jul/2007	18/Jul/2007	4.6	41.3	45.0	40.8	30.1	7.6	14.4	29.1	14.2	<1.0	37.7	24.0	21.4	76.7
18/Jul/2007	01/Aug/2007	6.7	23.8	<0.7	0.9	52.3	584.5	416.4	57.5	10.7	<1.0	17.5	0.2	54.4	14.6
01/Aug/2007	15/Aug/2007	6.3	101.5	<0.7	35.5	57.7	19.7	25.0	106.5	147.6	5.8	94.5	0.6	35.8	43.8
15/Aug/2007	29/Aug/2007	6.6	52.8	26.6	157.8	66.0	15.3	17.2	78.3	30.2	34.6	44.8	0.3	30.4	15.3
29/Aug/2007	12/Sep/2007	-	-	-	-	-	-	-	-	-	-	-	-	-	0.0
12/Sep/2007	26/Sep/2007	6.6	58.5	13.0	45.4	153.8	41.4	61.2	188.4	73.0	16.9	40.0	0.3	45.3	13.8
26/Sep/2007	17/Oct/2007	6.0	63.5	26.4	35.8	40.9	14.8	29.1	60.0	55.8	4.9	58.6	1.1	19.2	37.3
17/Oct/2007	31/Oct/2007	5.6	275.1	81.8	62.0	327.8	151.3	488.9	454.7	145.8	3.0	235.6	2.5	-	6.5
31/Oct/2007	14/Nov/2007	4.7	59.1	34.8	140.5	188.1	34.4	24.8	232.2	60.4	42.9	36.4	20.0	-	2.2
14/Nov/2007	28/Nov/2007	6.2	82.8	37.0	34.9	198.6	51.2	75.3	257.2	63.6	9.8	58.9	0.6	48.8	16.5
28/Nov/2007	12/Dec/2007	5.7	41.0	7.8	17.3	275.2	58.0	24.7	306.7	12.4	2.2	7.8	2.2	44.2	70.0
12/Dec/2007	04/Jan/2008	5.6	90.1	43.4	63.6	422.6	101.9	45.7	470.7	18.7	2.1	39.2	2.7	76.3	8.1
Precipitation<weighted annual means for site(samples containing phosphate are excluded)															Total rainfall
5007			54.3	16.6	25.0	169.3	53.7	36.6	196.3	28.4	1.7	33.9	9.6		631.5

# Harwell

**2007**

Site Code: 5170  
 Easting: 4468  
 Northing: 1860  
 Latitude: 51 34 15 N  
 Longitude: 1 19 34 W  
 Altitude (m): 120  
 Rainfall (mm): 636

[30 year mean 1940 - 1971]

Site Environment:  
**Rural. Former Airfield.**

Other measurements:  
**PAH, Metals, NOX, Ozone, VOC, SO2 Denuder**

Site Operator:

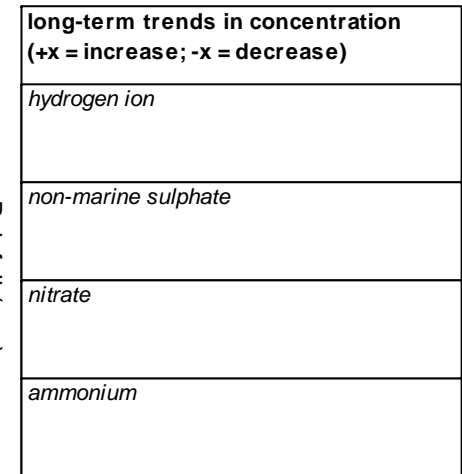
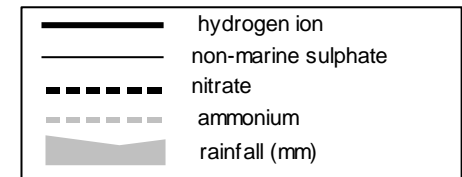
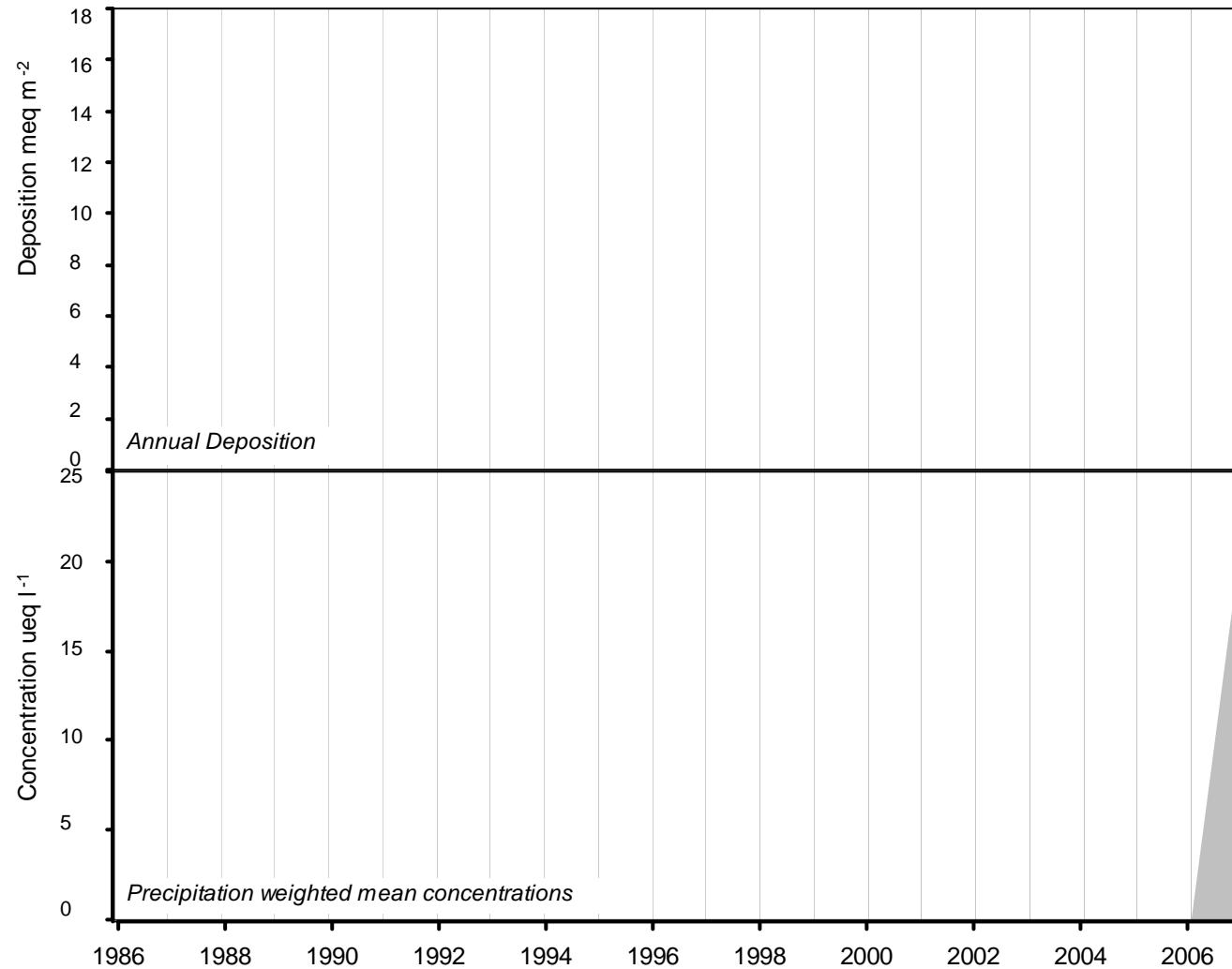

(5170) Harwell

Start Date	End Date	pH	SO4 (µeq/l)	NO3 (µeq/l)	NH4 (µeq/l)	Na (µeq/l)	Mg (µeq/l)	Ca (µeq/l)	Cl (µeq/l)	K (µeq/l)	PO4 (µeq/l)	Nss SO4 (µeq/l)	H+ (µeq/l)	Conductivity (S/cm)	Rainfall (mm)
09/Jan/2007	22/Jan/2007	5.5	21.0	6.5	14.5	122.8	22.8	8.0	130.3	1.9	1.5	6.2	3.2	20.9	55.2
22/Jan/2007	06/Feb/2007	4.7	46.2	37.3	59.9	132.0	21.0	27.1	125.4	14.3	8.5	30.3	20.0	-	2.5
06/Feb/2007	21/Feb/2007	4.8	27.9	27.1	34.2	60.3	11.4	10.5	65.0	1.7	<1.0	20.6	16.2	18.7	32.0
21/Feb/2007	05/Mar/2007	5.3	21.5	11.1	22.7	70.9	13.5	6.6	78.3	2.0	<1.0	13.0	5.4	15.0	53.7
05/Mar/2007	21/Mar/2007	6.0	36.2	13.1	22.9	159.0	30.0	26.7	172.9	4.1	<1.0	17.0	1.0	28.9	22.0
21/Mar/2007	02/Apr/2007	4.7	90.2	124.6	161.2	54.2	16.3	50.5	54.2	5.5	2.3	83.7	20.0	-	2.8
02/Apr/2007	17/Apr/2007	-	-	-	-	-	-	-	-	-	-	-	-	-	0.0
17/Apr/2007	30/Apr/2007	-	-	-	-	-	-	-	-	-	-	-	-	-	0.0
30/Apr/2007	18/May/2007	6.0	19.4	11.2	34.3	41.3	7.3	14.7	33.9	2.2	1.6	14.4	1.0	12.2	66.8
18/May/2007	01/Jun/2007	4.8	19.8	18.5	17.4	14.7	3.1	7.1	14.3	0.8	<1.0	18.1	15.8	11.2	71.6
01/Jun/2007	13/Jun/2007	-	-	-	-	-	-	-	-	-	-	-	-	-	0.0
13/Jun/2007	27/Jun/2007	5.0	14.5	16.6	13.0	11.0	3.0	7.4	12.4	1.8	<1.0	13.2	10.2	8.4	82.3
27/Jun/2007	15/Jul/2007	5.2	20.2	16.4	7.2	30.6	7.5	13.3	39.7	1.9	<1.0	16.5	6.6	10.3	31.8
15/Jul/2007	06/Aug/2007	4.7	19.6	18.6	15.1	15.0	2.6	7.9	14.2	1.6	<1.0	17.8	22.4	12.0	106.5
06/Aug/2007	03/Sep/2007	4.7	26.0	24.3	11.9	24.3	9.7	29.3	25.1	2.1	2.5	23.0	18.6	9.5	36.7
03/Sep/2007	01/Oct/2007	6.2	42.2	36.7	37.5	59.4	17.4	53.1	70.5	4.6	3.3	35.0	0.6	21.4	37.1
01/Oct/2007	05/Nov/2007	4.4	42.6	56.6	21.6	38.2	12.0	24.9	35.8	1.4	1.4	38.0	41.7	28.4	23.9
05/Nov/2007	03/Dec/2007	5.0	25.9	24.6	27.5	77.4	16.2	11.0	80.5	2.5	<1.0	16.6	10.5	16.5	58.7
03/Dec/2007	14/Dec/2007	5.1	19.6	6.1	13.1	83.5	16.1	8.7	93.5	3.1	<1.0	9.6	7.6	17.3	27.0
14/Dec/2007	24/Dec/2007	-	-	-	-	-	-	-	-	-	-	-	-	-	0.3
24/Dec/2007	17/Jan/2008	5.1	18.4	10.9	14.2	89.7	17.5	6.4	94.8	2.5	<1.0	7.6	8.5	16.7	118.4
5170			22.6	18.1	20.1	54.5	11.2	12.8	57.5	2.2	0.9	16.1	11.2		Total rainfall 829.1

# Rothamsted

2007

Site Code: 5165  
 Easting: 5131  
 Northing: 2132  
 Latitude: 51 48 23 N  
 Longitude: 00 27 37 W  
 Altitude (m): 130  
 Rainfall (mm): 765  
 [30 year mean 1940 - 1971]

Site Environment:  
 Pasture

Other measurements:  
 ECN, HNO3 Denuder

Site Operator:  
 Rothamsted Experimental Station

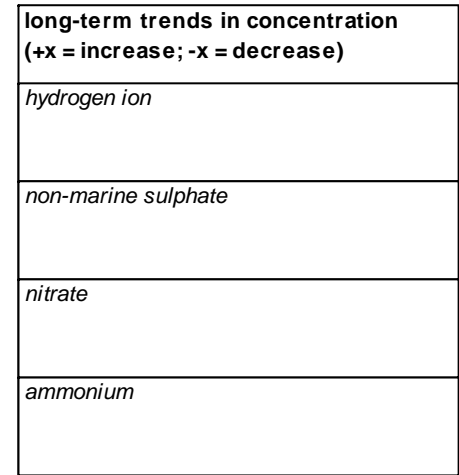
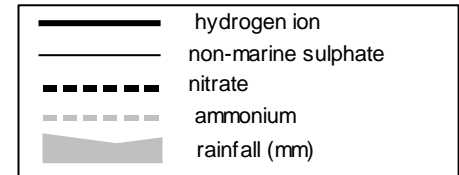
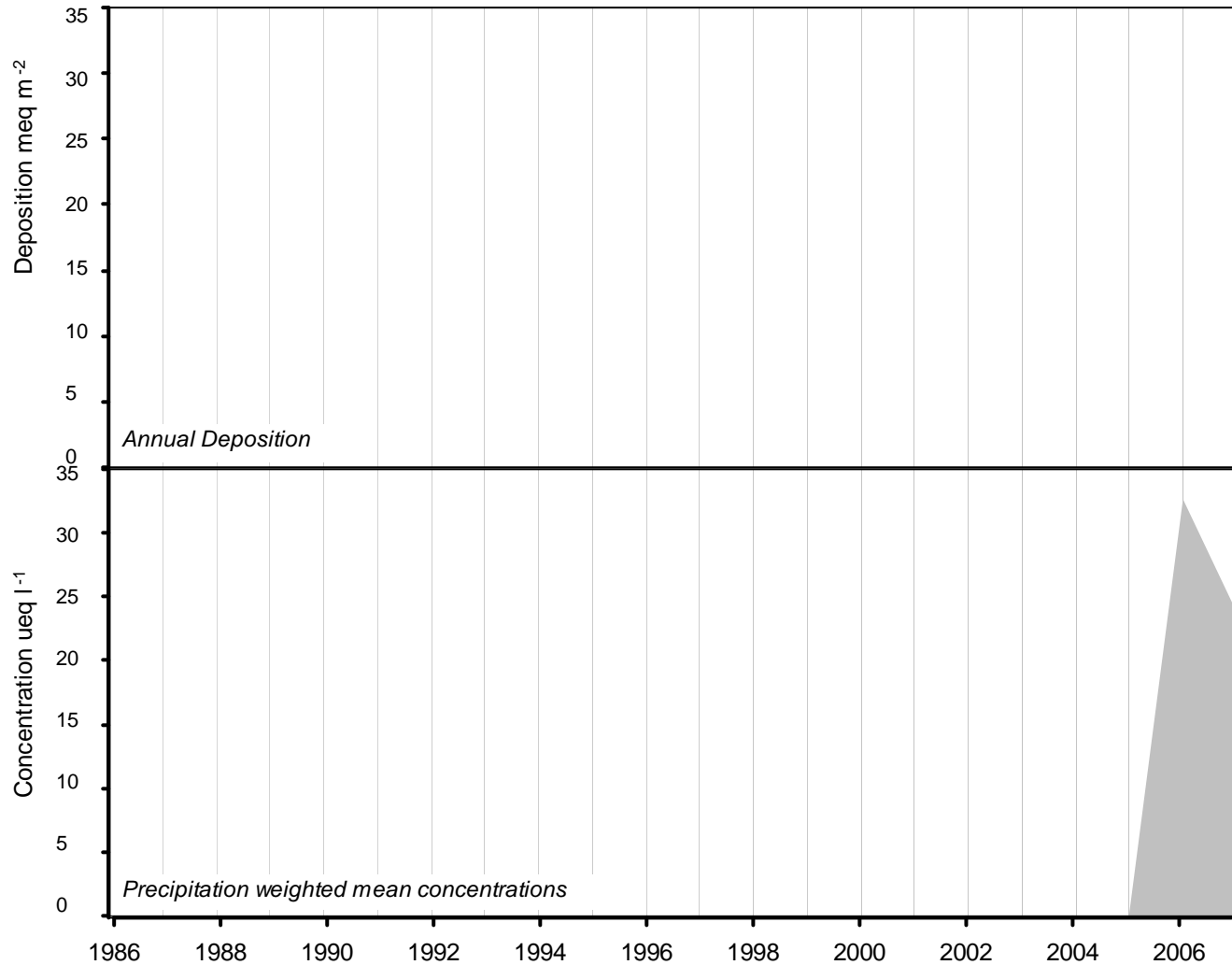

(5165) Rothamsted

Start Date	End Date	pH	SO4 (µeq/l)	NO3 (µeq/l)	NH4 (µeq/l)	Na (µeq/l)	Mg (µeq/l)	Ca (µeq/l)	Cl (µeq/l)	K (µeq/l)	PO4 (µeq/l)	Nss SO4 (µeq/l)	H+ (µeq/l)	Conductivity (S/cm)	Rainfall (mm)
04/Jan/2007	25/Jan/2007	4.9	24.2	13.9	13.9	85.1	16.5	7.1	84.3	5.3	<1.0	14.0	14.1	17.7	57.3
25/Jan/2007	08/Feb/2007	-	-	-	-	-	-	-	-	-	-	-	-	-	0.0
08/Feb/2007	21/Feb/2007	4.5	22.3	27.5	18.5	47.4	9.9	7.0	53.0	1.0	<1.0	16.6	29.5	20.3	45.1
21/Feb/2007	07/Mar/2007	4.4	21.6	17.5	23.6	67.0	12.7	8.1	67.4	1.9	<1.0	13.5	39.8	-	60.4
07/Mar/2007	21/Mar/2007	6.2	62.8	35.9	47.1	164.1	31.6	44.2	171.8	5.0	<1.0	43.0	0.6	35.3	5.7
21/Mar/2007	04/Apr/2007	5.4	241.6	269.5	316.4	230.1	62.6	174.5	236.1	15.1	<1.0	213.8	3.7	98.4	3.4
04/Apr/2007	18/Apr/2007	-	-	-	-	-	-	-	-	-	-	-	-	-	0.0
18/Apr/2007	02/May/2007	4.7	197.4	233.8	235.9	93.9	46.4	214.5	84.8	31.0	<1.0	186.0	20.0	-	1.1
02/May/2007	16/May/2007	5.2	24.4	17.7	33.0	34.3	7.1	14.8	30.0	1.3	<1.0	20.3	7.1	12.4	54.8
16/May/2007	30/May/2007	4.7	19.5	27.0	21.6	15.4	3.7	8.8	15.2	1.2	<1.0	17.6	20.9	13.5	58.1
30/May/2007	13/Jun/2007	5.7	42.8	57.3	14.8	84.7	13.2	68.9	76.5	21.9	<1.0	32.6	1.9	26.0	3.7
13/Jun/2007	27/Jun/2007	4.5	30.4	36.8	24.7	12.8	4.2	12.0	14.2	2.1	<1.0	28.8	33.9	18.7	43.2
27/Jun/2007	11/Jul/2007	4.8	23.8	16.2	16.3	25.8	6.0	10.8	29.3	2.5	<1.0	20.7	15.5	11.4	31.4
11/Jul/2007	25/Jul/2007	4.7	33.6	40.8	39.7	16.8	7.2	16.0	15.4	1.9	<1.0	31.6	21.4	16.8	47.2
25/Jul/2007	08/Aug/2007	5.7	27.5	35.9	30.0	40.8	9.5	30.2	33.5	3.7	3.5	22.6	2.2	11.3	15.8
08/Aug/2007	22/Aug/2007	6.1	28.2	29.7	32.1	22.9	5.9	49.2	23.8	1.6	4.2	25.4	0.8	11.4	42.6
22/Aug/2007	05/Sep/2007	5.6	74.2	62.2	50.7	87.3	21.8	75.0	95.3	5.8	<1.0	63.7	2.5	28.2	10.0
05/Sep/2007	19/Sep/2007	-	-	-	-	-	-	-	-	-	-	-	-	-	0.0
19/Sep/2007	03/Oct/2007	5.7	33.2	27.5	30.9	80.9	18.4	25.7	93.2	2.8	<1.0	23.4	2.1	19.1	24.1
03/Oct/2007	31/Oct/2007	4.6	36.5	52.9	43.5	23.3	6.3	13.1	22.9	2.3	1.3	33.7	26.9	18.4	40.7
31/Oct/2007	14/Nov/2007	4.7	63.8	37.1	64.3	203.2	37.1	47.6	210.3	7.8	2.8	39.4	20.0	-	7.4
14/Nov/2007	28/Nov/2007	4.5	26.3	33.6	28.8	41.1	9.1	8.2	44.0	1.6	1.4	21.3	29.5	19.8	49.6
28/Nov/2007	12/Dec/2007	4.9	17.8	10.4	12.7	71.6	14.5	7.6	78.8	2.1	2.4	9.2	14.1	16.3	44.4
12/Dec/2007	09/Jan/2008	4.6	37.0	39.1	40.0	102.9	21.3	11.6	107.5	2.8	<1.0	24.6	26.3	29.2	31.6
5165			29.2	29.7	29.3	49.4	10.8	16.9	51.0	2.5	1.1	23.2	19.9		Total rainfall 677.6

# Crai Reservoir

2007

Site Code: 5154  
 Easting: 2882  
 Northing: 2219  
 Latitude: 51 53 25 N  
 Longitude: 03 37 10 W  
 Altitude (m): 310  
 Rainfall (mm): 2339  
 [30 year mean 1940 - 1971]

Site Environment:

Bank of Crai Reservoir in valley. Sheep grazing.

Other measurements:

---

Site Operator:

Welsh Water

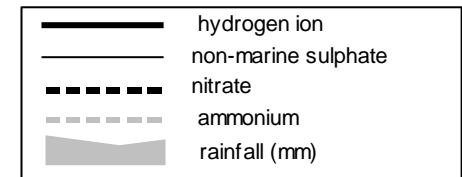
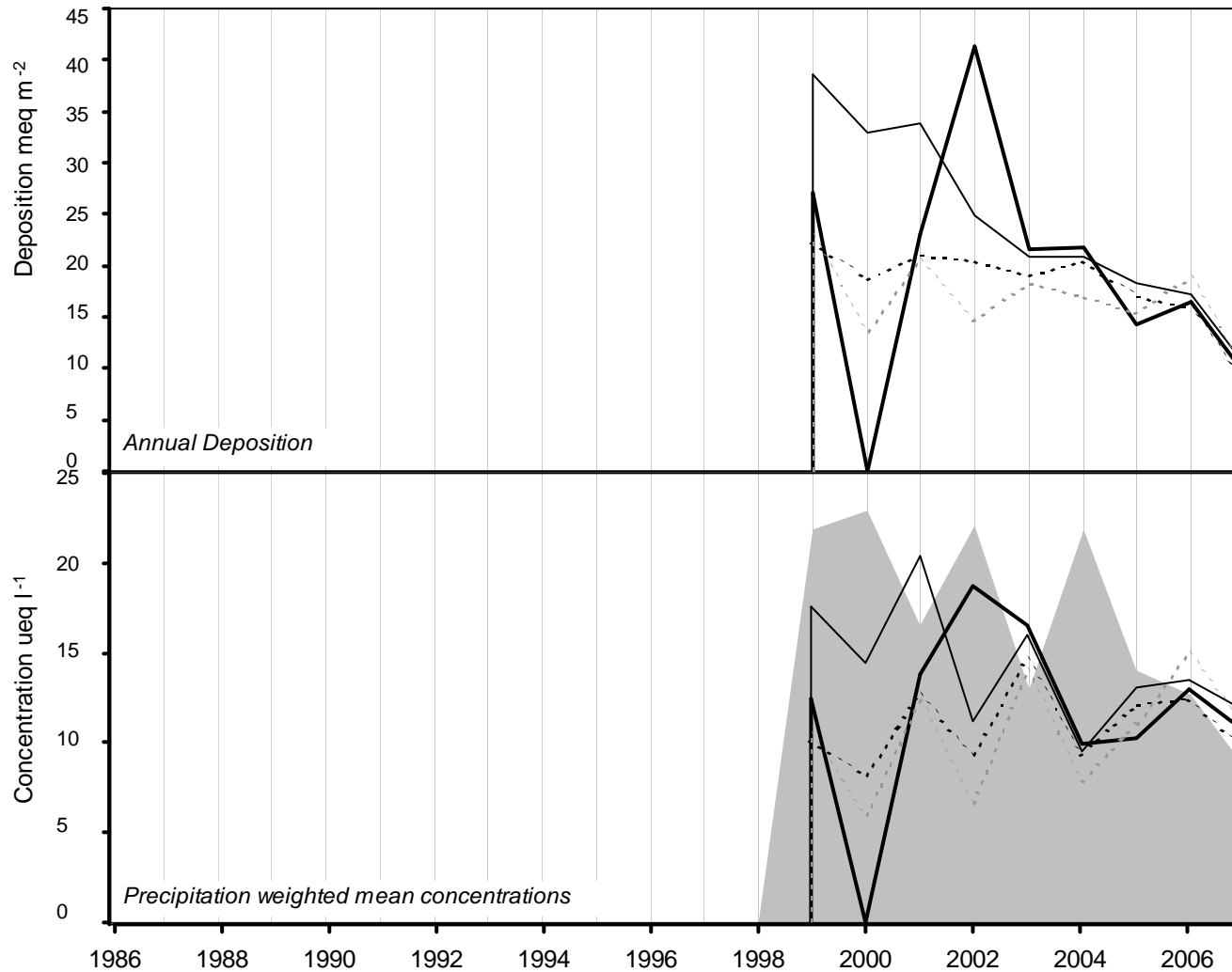

long-term trends in concentration (+x = increase; -x = decrease)	
<i>hydrogen ion</i>	-0.35 ueq/l (-1.83 %/year): 8 years' data - No significant trend detected
<i>non-marine sulphate</i>	-0.70 ueq/l (-2.69 %/year): 9 years' data - No significant trend detected
<i>nitrate</i>	0.35 ueq/l (6.76 %/year): 9 years' data - No significant trend detected
<i>ammonium</i>	0.72 ueq/l (-50.51 %/year): 9 years' data - No significant trend detected

### (5154) Crai Reservoir

Start Date	End Date	pH	SO4 (µeq/l)	NO3 (µeq/l)	NH4 (µeq/l)	Na (µeq/l)	Mg (µeq/l)	Ca (µeq/l)	Cl (µeq/l)	K (µeq/l)	PO4 (µeq/l)	Nss SO4 (µeq/l)	H+ (µeq/l)	Conductivity (S/cm)	Rainfall (mm)
29/Jan/2007	01/Mar/2007	5.0	30.8	5.7	10.9	173.0	35.1	10.0	187.2	3.5	<1.0	9.9	11.2	29.8	92.5
01/Mar/2007	30/Mar/2007	-	-	-	-	-	-	-	-	-	-	-	-	-	0.0
30/Mar/2007	30/Apr/2007	5.7	43.7	31.7	29.3	6.4	16.8	32.4	7.8	4.2	<1.0	42.9	2.0	12.8	39.0
30/Apr/2007	30/May/2007	7.3	198.2	11.7	75.9	429.9	34.1	188.0	147.3	32.4	2.5	146.5	0.1	89.0	8.7
30/May/2007	29/Jun/2007	-	-	-	-	-	-	-	-	-	-	-	-	-	0.0
29/Jun/2007	30/Jul/2007	-	-	-	-	-	-	-	-	-	-	-	-	-	0.0
30/Jul/2007	31/Aug/2007	4.8	14.8	8.0	10.5	30.1	14.3	9.3	35.5	1.6	2.2	11.2	16.6	7.2	96.1
31/Aug/2007	28/Sep/2007	5.5	22.3	12.5	12.8	62.8	14.9	9.0	74.2	2.0	<1.0	14.8	3.2	13.9	119.2
28/Sep/2007	07/Nov/2007	5.0	21.1	15.5	21.8	58.8	11.9	7.0	61.6	2.2	2.1	14.1	10.7	15.2	28.3
07/Nov/2007	03/Dec/2007	4.8	17.6	6.6	5.3	95.2	19.7	7.1	103.7	2.6	<1.0	6.2	14.5	19.7	261.5
03/Dec/2007	03/Jan/2008	5.0	30.4	9.3	9.9	196.0	40.8	11.7	210.2	4.1	2.1	6.8	9.5	32.1	223.9
5154		Precipitation<weighted annual means for site(samples containing phosphate are excluded)													
			25.7	9.6	11.0	116.0	25.3	12.0	123.2	3.2	1.2	11.8	10.7	Total rainfall 869.3	

# Flatford Mill

2007

Site Code: 5024  
 Easting: 6077  
 Northing: 2333  
 Latitude: 51 57 32 N  
 Longitude: 01 01 24 E  
 Altitude (m): 5  
 Rainfall (mm): 599  
 [30 year mean 1940 - 1971]

Site Environment:  
 Open meadow near River Stour

Other measurements:  
 DT

Site Operator:  
 Field Studies Council

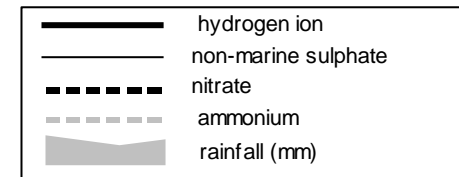
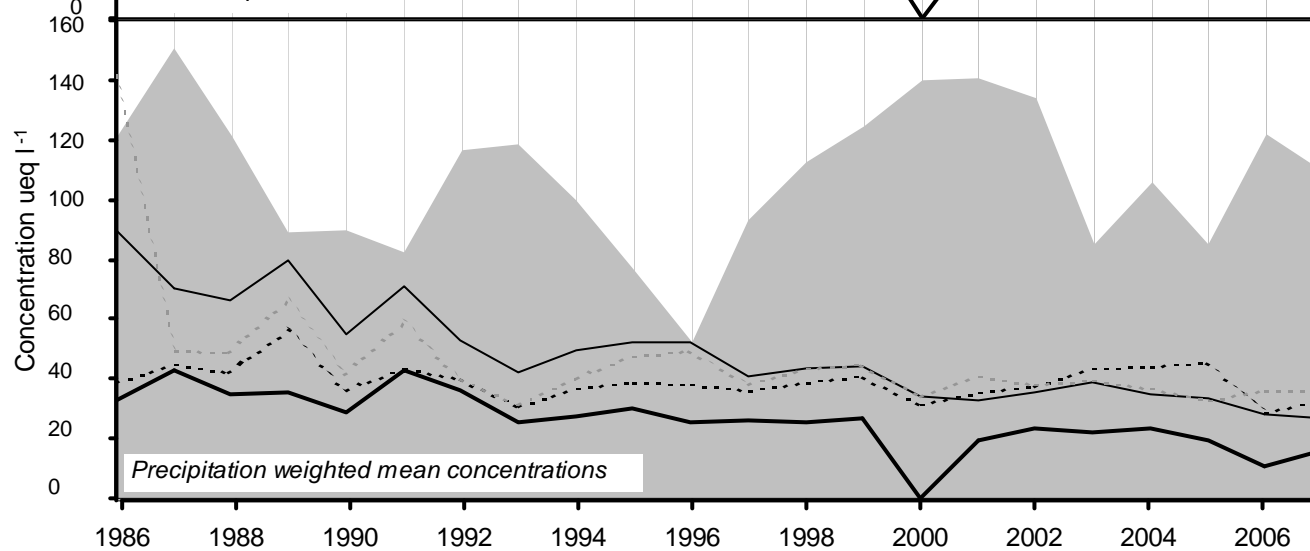
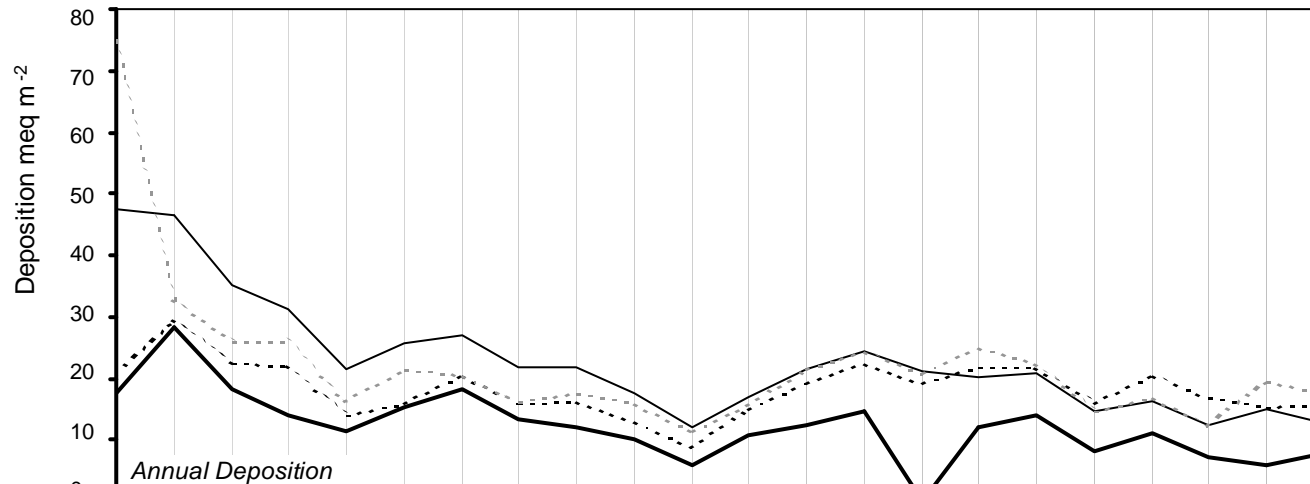

long-term trends in concentration (+x = increase; -x = decrease)	
<i>hydrogen ion</i>	-1.18 ueq/l (-3.04 %/year): 21 years' data ++++ Very strong trend detected
<i>non-marine sulphate</i>	-2.44 ueq/l (-3.27 %/year): 22 years' data ++++ Very strong trend detected
<i>nitrate</i>	-0.38 ueq/l (-0.88 %/year): 22 years' data - No significant trend detected
<i>ammonium</i>	-0.89 ueq/l (-1.70 %/year): 21 years' data ++ Moderately strong trend detected



(5024) Flatford Mill

Start Date	End Date	pH	SO4 (µeq/l)	NO3 (µeq/l)	NH4 (µeq/l)	Na (µeq/l)	Mg (µeq/l)	Ca (µeq/l)	Cl (µeq/l)	K (µeq/l)	PO4 (µeq/l)	Nss SO4 (µeq/l)	H+ (µeq/l)	Conductivity (S/cm)	Rainfall (mm)	
09/Jan/2007	23/Jan/2007	5.1	36.2	17.5	28.5	149.6	27.6	15.0	133.5	2.9	<1.0	18.2	7.2	25.7	26.2	
23/Jan/2007	06/Feb/2007	-	-	-	-	-	-	-	-	-	-	-	-	-	0.0	
06/Feb/2007	20/Feb/2007	4.4	38.2	44.0	39.3	100.8	21.8	10.2	107.0	3.7	<1.0	26.1	37.2	30.6	33.2	
20/Feb/2007	06/Mar/2007	4.8	24.6	19.6	23.8	71.2	15.4	7.8	74.1	3.0	<1.0	16.0	15.5	18.3	47.5	
06/Mar/2007	20/Mar/2007	6.1	31.4	17.0	25.7	111.2	20.3	18.5	113.9	3.9	<1.0	18.1	0.8	21.4	17.5	
20/Mar/2007	02/Apr/2007	5.6	153.8	148.4	234.0	278.0	65.0	82.7	296.8	18.4	13.0	120.3	2.8	81.1	4.1	
02/Apr/2007	17/Apr/2007	-	-	-	-	-	-	-	-	-	-	-	-	-	0.0	
17/Apr/2007	01/May/2007	-	-	-	-	-	-	-	-	-	-	-	-	-	0.0	
01/May/2007	15/May/2007	5.7	28.9	21.1	48.5	57.3	10.4	14.4	48.7	3.5	1.5	22.0	1.9	16.5	42.4	
15/May/2007	29/May/2007	4.8	21.4	24.8	21.3	20.0	4.7	8.9	16.8	2.0	2.1	19.0	15.8	12.6	47.6	
29/May/2007	12/Jun/2007	4.9	22.2	39.9	15.8	14.3	6.3	21.2	16.0	5.7	1.9	20.4	12.0	13.2	11.0	
12/Jun/2007	26/Jun/2007	4.5	31.1	36.3	27.2	17.1	5.3	12.4	19.8	3.8	2.0	29.1	30.9	20.0	49.5	
26/Jun/2007	10/Jul/2007	4.7	25.5	23.2	21.3	17.7	6.0	10.7	22.7	2.4	<1.0	23.4	19.1	12.8	34.2	
10/Jul/2007	24/Jul/2007	4.7	70.8	71.7	72.2	84.8	22.3	41.4	93.2	7.5	2.1	60.5	20.4	35.2	32.4	
24/Jul/2007	07/Aug/2007	4.7	28.0	26.1	51.0	51.4	6.9	19.1	38.3	7.6	8.5	21.8	20.0	-	3.4	
07/Aug/2007	21/Aug/2007	5.0	42.5	49.0	70.0	55.9	9.8	25.1	51.6	14.9	7.3	35.7	10.0	-	20.7	
21/Aug/2007	04/Sep/2007	4.7	116.8	99.5	177.7	189.7	38.2	42.5	212.5	15.5	12.4	93.9	20.0	-	2.1	
04/Sep/2007	18/Sep/2007	-	-	-	-	-	-	-	-	-	-	-	-	-	0.0	
18/Sep/2007	02/Oct/2007	5.5	48.2	43.6	43.4	126.5	29.6	32.6	153.0	8.4	<1.0	32.9	3.4	29.0	25.8	
02/Oct/2007	16/Oct/2007	4.7	21.2	31.8	25.3	16.8	5.7	10.1	15.1	2.2	13.5	5.7	19.2	12.8	18.2	
16/Oct/2007	30/Oct/2007	4.8	41.0	40.7	42.7	33.5	8.3	13.6	34.2	3.2	<1.0	37.0	16.6	17.2	16.6	
30/Oct/2007	14/Nov/2007	4.7	95.5	54.1	92.7	191.3	53.6	53.3	210.2	9.9	3.6	72.5	20.0	-	4.6	
14/Nov/2007	27/Nov/2007	4.7	42.9	50.3	43.6	146.3	29.8	17.4	157.9	5.9	2.8	25.3	20.0	-	15.2	
27/Nov/2007	11/Dec/2007	5.0	26.3	18.0	23.2	102.2	20.0	10.6	108.8	3.3	2.0	14.0	11.0	18.8	25.0	
11/Dec/2007	02/Jan/2008	5.0	57.0	52.5	72.4	169.3	34.5	24.4	176.7	9.5	1.4	36.6	10.0	-	1.9	
			Precipitation<weighted annual means for site(samples containing phosphate are excluded)													Total rainfall
5024			34.9	33.1	36.4	69.2	15.1	16.5	71.5	4.5	1.6	26.6	16.1	479.3		

# Tycanol Wood

2007

Site Code: 5123  
 Easting: 2093  
 Northing: 2364  
 Latitude: 51 59 34 N  
 Longitude: 04 46 41 W  
 Altitude (m): 205  
 Rainfall (mm): 1133  
 [30 year mean 1940 - 1971]

Site Environment:  
 Open moorland

Other measurements:  
 DT

Site Operator:  
 Countryside Council for Wales

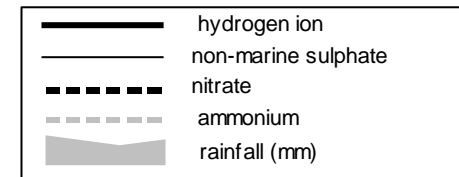

long-term trends in concentration (+x = increase; -x = decrease)	
<i>hydrogen ion</i>	-0.15 ueq/l (-0.87 %/year): 21 years' data - No significant trend detected
<i>non-marine sulphate</i>	-0.57 ueq/l (-2.09 %/year): 22 years' data +++ Strong trend detected
<i>nitrate</i>	0.00 ueq/l (-0.02 %/year): 22 years' data - No significant trend detected
<i>ammonium</i>	0.15 ueq/l (1.05 %/year): 22 years' data - No significant trend detected

### (5123) Tycanol Wood

Start Date	End Date	pH	SO4 (µeq/l)	NO3 (µeq/l)	NH4 (µeq/l)	Na (µeq/l)	Mg (µeq/l)	Ca (µeq/l)	Cl (µeq/l)	K (µeq/l)	PO4 (µeq/l)	Nss SO4 (µeq/l)	H+ (µeq/l)	Conductivity (S/cm)	Rainfall (mm)
05/Jan/2007	10/Jan/2007	5.2	45.1	4.9	15.8	349.7	71.0	15.9	382.3	2.2	<1.0	3.0	5.8	55.0	106.6
10/Jan/2007	24/Jan/2007	5.3	33.3	4.4	8.6	275.7	56.8	12.2	279.9	3.9	<1.0	0.1	5.2	40.3	62.7
24/Jan/2007	07/Feb/2007	-	-	-	-	-	-	-	-	-	-	-	-	-	0.0
07/Feb/2007	21/Feb/2007	5.1	24.4	7.7	8.5	142.1	26.3	6.2	164.2	2.5	<1.0	7.3	8.5	24.1	126.4
21/Feb/2007	07/Mar/2007	5.1	23.5	7.4	8.1	152.6	31.5	8.8	157.3	3.0	<1.0	5.1	8.9	25.8	147.2
07/Mar/2007	21/Mar/2007	4.9	51.1	19.6	24.1	287.7	61.7	17.9	309.2	6.3	<1.0	16.5	12.0	49.5	26.1
21/Mar/2007	04/Apr/2007	-	-	-	-	-	-	-	-	-	-	-	-	-	0.0
04/Apr/2007	18/Apr/2007	-	-	-	-	-	-	-	-	-	-	-	-	-	0.0
18/Apr/2007	02/May/2007	4.4	50.9	27.2	36.7	28.9	8.7	15.7	32.5	1.4	<1.0	47.4	38.0	22.6	45.8
02/May/2007	23/May/2007	5.7	20.0	8.6	13.7	67.3	12.8	14.4	70.3	1.8	<1.0	11.8	1.8	14.0	95.6
23/May/2007	30/May/2007	5.7	43.4	19.6	38.3	168.6	29.9	16.1	174.5	5.0	2.1	23.1	1.8	31.7	17.3
30/May/2007	13/Jun/2007	4.7	96.0	87.1	111.7	69.5	16.7	33.2	67.9	4.0	<1.0	87.6	20.0	-	3.7
13/Jun/2007	27/Jun/2007	-	-	-	-	-	-	-	-	-	-	-	-	-	0.0
27/Jun/2007	11/Jul/2007	5.6	20.7	8.2	28.9	54.1	5.8	3.2	51.7	4.6	<1.0	14.2	2.3	13.5	207.0
11/Jul/2007	25/Jul/2007	5.7	20.5	8.3	25.6	65.0	5.6	2.8	60.0	7.4	<1.0	12.7	1.9	14.0	96.9
25/Jul/2007	08/Aug/2007	4.3	43.3	11.1	16.9	75.8	16.9	8.0	82.9	2.1	<1.0	34.1	51.3	21.3	35.0
08/Aug/2007	22/Aug/2007	4.7	20.5	7.4	10.9	60.6	15.1	7.3	71.1	1.8	3.6	13.2	21.4	11.8	62.0
22/Aug/2007	05/Sep/2007	-	-	-	-	-	-	-	-	-	-	-	-	-	0.0
05/Sep/2007	19/Sep/2007	-	-	-	-	-	-	-	-	-	-	-	-	-	0.0
19/Sep/2007	03/Oct/2007	6.4	84.0	14.0	542.6	102.2	9.1	5.8	115.2	57.9	136.3	71.7	0.4	87.5	91.4
03/Oct/2007	17/Oct/2007	4.7	17.1	24.3	16.9	67.8	13.9	10.7	61.4	2.1	<1.0	9.0	20.0	-	14.6
17/Oct/2007	31/Oct/2007	4.6	41.6	11.3	21.2	84.5	17.7	8.2	88.9	2.0	2.7	31.5	23.4	21.0	25.1
31/Oct/2007	14/Nov/2007	5.0	57.0	12.2	41.7	393.8	72.0	27.1	429.4	11.2	2.8	9.5	10.0	-	6.5
14/Nov/2007	28/Nov/2007	5.8	42.5	22.2	16.5	217.7	47.8	15.8	232.5	8.0	7.0	16.3	1.6	35.3	105.9
28/Nov/2007	12/Dec/2007	5.5	47.2	2.6	8.1	385.9	80.5	21.3	415.8	8.2	<1.0	0.8	3.1	61.6	17.2
12/Dec/2007	02/Jan/2008	4.7	66.8	30.3	25.4	382.7	78.8	24.8	398.9	8.8	2.1	20.7	20.0	65.8	80.8
5123			32.4	11.7	18.6	158.8	31.3	10.7	168.1	4.3	1.4	13.3	9.5		Total rainfall 1373.7

# Ystradffin

2007

Site Code: 5169  
 Easting: 2788  
 Northing: 2471  
 Latitude: 52 07 47N  
 Longitude: 03 44 26W  
 Altitude (m): 230  
 Rainfall (mm): 1774

[30 year mean 1940 - 1971]

Site Environment:  
 Nature Reserve. Relocated from Llynn Brienne.

Other measurements:

Site Operator:  
 Environment Agency Wales

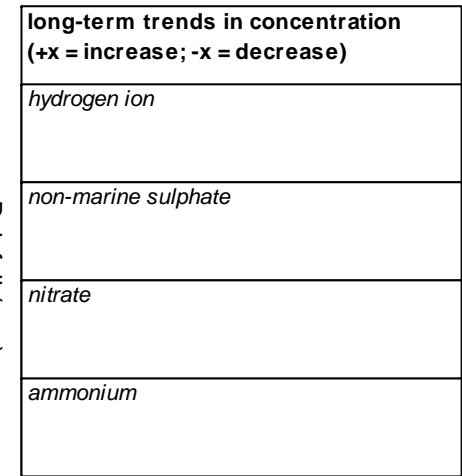
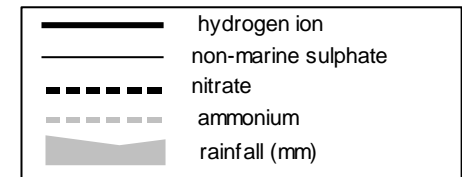
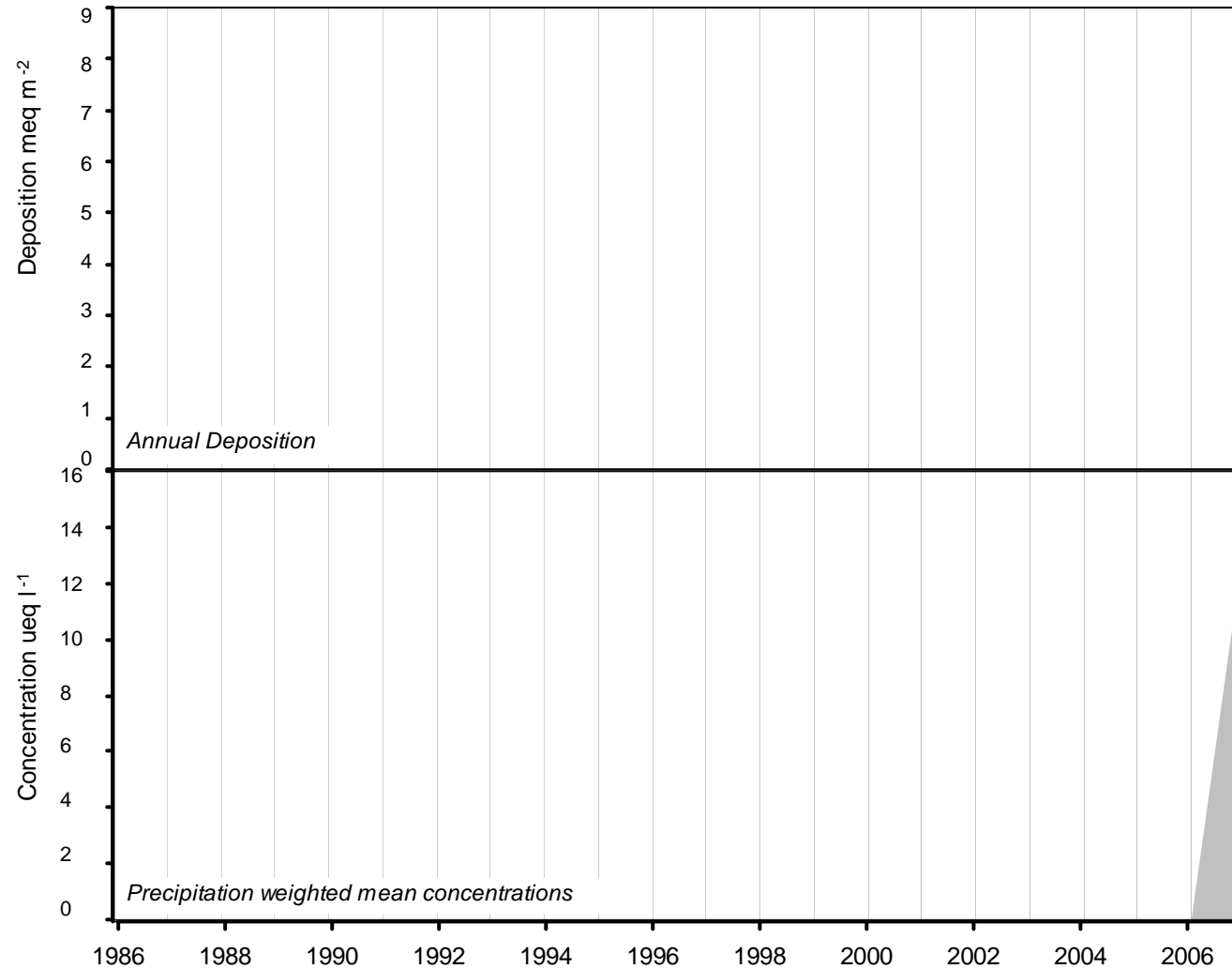

(5169) Ystradffin

Start Date	End Date	pH	SO4 (µeq/l)	NO3 (µeq/l)	NH4 (µeq/l)	Na (µeq/l)	Mg (µeq/l)	Ca (µeq/l)	Cl (µeq/l)	K (µeq/l)	PO4 (µeq/l)	Nss SO4 (µeq/l)	H+ (µeq/l)	Conductivity (S/cm)	Rainfall (mm)
06/Sep/2007	25/Sep/2007	5.2	18.1	5.7	10.6	86.6	20.5	9.5	94.7	2.3	<1.0	7.7	6.3	12.1	89.2
25/Sep/2007	12/Oct/2007	4.7	30.2	27.9	34.2	48.2	9.6	11.5	46.5	5.3	2.8	24.4	20.0	-	14.2
12/Oct/2007	02/Nov/2007	4.9	26.3	21.8	25.9	50.7	8.9	8.0	51.3	2.0	<1.0	20.2	12.9	14.2	61.4
02/Nov/2007	19/Nov/2007	4.9	30.5	20.0	20.3	152.4	30.0	13.7	161.7	3.7	<1.0	12.2	11.5	26.9	74.7
19/Nov/2007	03/Dec/2007	5.2	25.6	9.9	12.5	145.2	28.8	11.9	157.5	3.1	2.1	8.1	6.5	24.7	75.8
03/Dec/2007	13/Dec/2007	5.3	24.7	2.6	7.1	181.6	35.7	10.3	193.0	3.7	<1.0	2.8	5.4	25.8	106.2
13/Dec/2007	07/Jan/2008	4.9	28.8	15.8	15.2	165.7	33.5	10.9	176.3	3.5	2.2	8.9	11.7	29.1	97.2
Precipitation<weighted annual means for site(samples containing phosphate are excluded)															Total rainfall
5169			25.6	12.2	14.9	133.6	27.0	10.7	142.5	3.2	1.1	9.5	9.1		518.7

# Pumlumon

2007

Site Code: 5150  
 Easting: 2823  
 Northing: 2854  
 Latitude: 52 27 13 N  
 Longitude: 03 43 56 W  
 Altitude (m): 390  
 Rainfall (mm): 3079  
 [30 year mean 1940 - 1971]

Site Environment:  
 Open moorland, upland hill farming

Other measurements:  
 DT, UKAWMN (nearby)

Site Operator:  
 Centre for Ecology and Hydrology (Bangor)

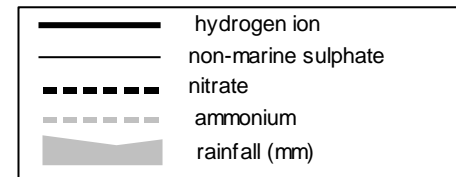

long-term trends in concentration (+x = increase; -x = decrease)	
<i>hydrogen ion</i>	-0.55 ueq/l (-3.03 %/year): 18 years' data +++ Strong trend detected
<i>non-marine sulphate</i>	-0.82 ueq/l (-3.19 %/year): 19 years' data ++++ Very strong trend detected
<i>nitrate</i>	-0.18 ueq/l (-1.34 %/year): 19 years' data - No significant trend detected
<i>ammonium</i>	-0.20 ueq/l (-1.25 %/year): 19 years' data - No significant trend detected

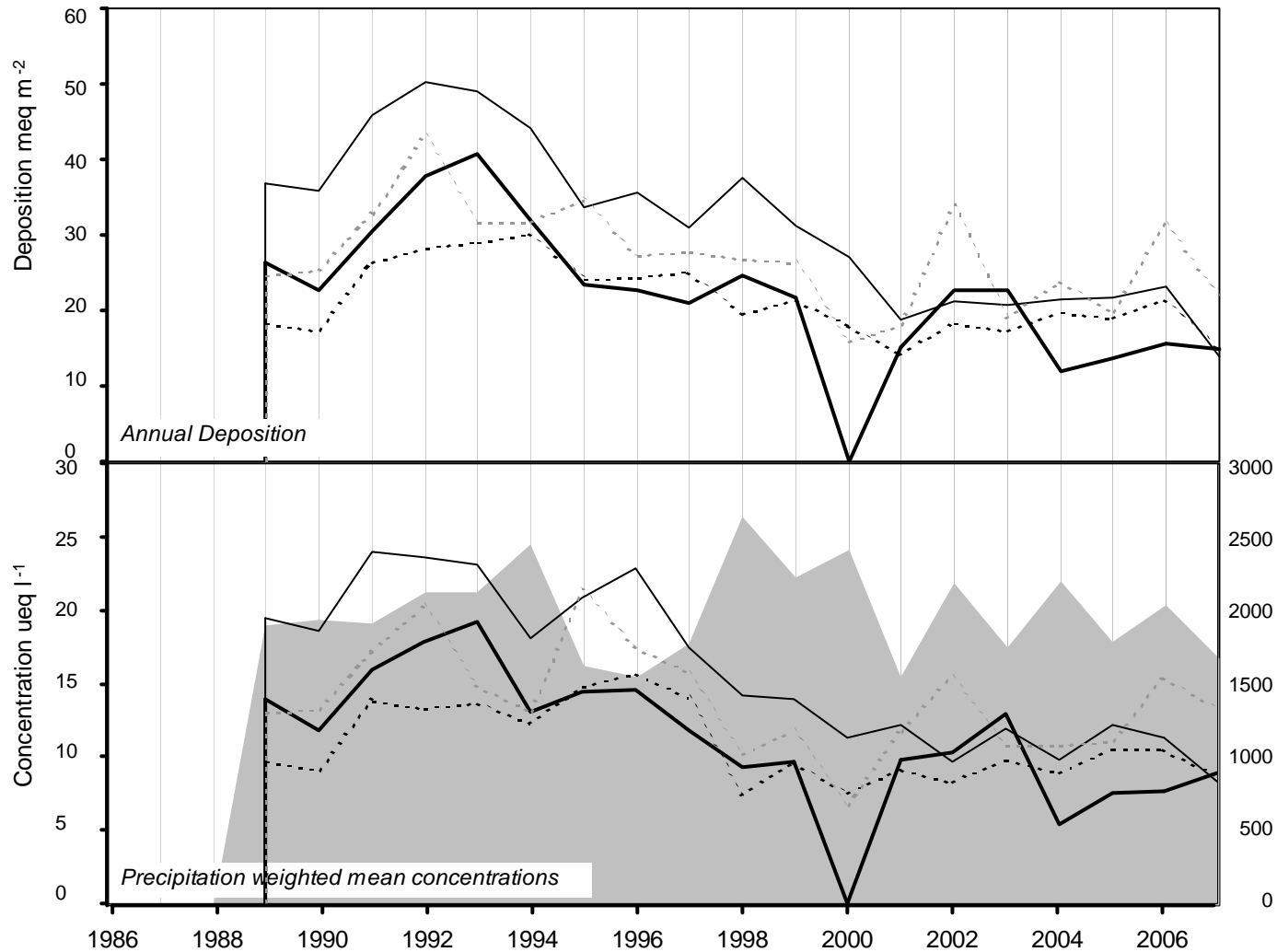

## (5150) Pumlumon

Start Date	End Date	pH	SO4 (µeq/l)	NO3 (µeq/l)	NH4 (µeq/l)	Na (µeq/l)	Mg (µeq/l)	Ca (µeq/l)	Cl (µeq/l)	K (µeq/l)	PO4 (µeq/l)	Nss SO4 (µeq/l)	H+ (µeq/l)	Conductivity (S/cm)	Rainfall (mm)
02/Jan/2007	09/Jan/2007	5.3	18.0	1.6	9.1	102.8	20.2	4.9	108.8	2.3	1.9	5.6	5.2	18.4	129.9
09/Jan/2007	23/Jan/2007	5.4	24.4	1.8	8.6	184.0	36.3	8.2	193.5	2.8	<1.0	2.3	4.3	27.7	193.7
23/Jan/2007	06/Feb/2007	4.7	30.9	22.8	45.7	124.4	20.3	9.0	141.9	2.7	<1.0	15.9	20.0	-	6.0
06/Feb/2007	21/Feb/2007	4.8	14.7	11.2	10.4	79.0	13.8	5.4	86.6	1.8	<1.0	5.2	14.8	17.8	82.8
21/Feb/2007	06/Mar/2007	5.3	18.5	5.4	9.3	121.8	22.9	6.3	124.9	2.4	<1.0	3.9	5.2	19.3	143.5
06/Mar/2007	20/Mar/2007	5.8	28.7	8.3	20.8	166.4	30.8	7.9	174.4	3.2	<1.0	8.6	1.7	26.3	60.1
20/Mar/2007	03/Apr/2007	7.1	162.7	64.9	967.2	314.6	34.0	39.5	137.4	101.5	134.9	124.8	0.1	158.2	10.8
03/Apr/2007	17/Apr/2007	-	-	-	-	-	-	-	-	-	-	-	-	-	0.0
17/Apr/2007	15/May/2007	6.1	23.1	9.3	72.3	47.3	4.1	3.4	52.2	10.4	15.8	17.4	0.7	18.2	150.9
15/May/2007	29/May/2007	5.0	21.9	8.5	10.5	109.9	21.0	8.5	117.4	2.8	<1.0	8.6	10.0	20.9	60.4
29/May/2007	12/Jun/2007	4.8	53.4	63.2	78.3	23.6	6.9	21.7	25.4	2.6	<1.0	50.5	17.4	22.8	15.3
12/Jun/2007	26/Jun/2007	5.0	15.8	15.6	20.0	11.5	3.5	4.6	13.0	0.8	<1.0	14.5	11.2	8.8	113.3
26/Jun/2007	10/Jul/2007	4.9	15.7	4.8	6.4	60.1	11.2	4.2	73.7	1.2	<1.0	8.4	11.7	13.4	197.9
10/Jul/2007	24/Jul/2007	6.1	21.5	13.2	72.5	12.5	0.8	<1.0	9.7	6.9	15.3	20.0	0.8	13.4	126.7
24/Jul/2007	07/Aug/2007	6.2	29.7	8.0	160.0	45.0	4.4	2.8	47.9	13.3	51.0	24.3	0.6	28.1	52.6
07/Aug/2007	21/Aug/2007	4.9	15.6	8.4	10.7	45.4	8.7	5.0	52.4	1.6	<1.0	10.1	13.2	8.8	56.7
21/Aug/2007	04/Sep/2007	5.6	23.3	15.4	22.2	64.5	11.5	12.2	69.0	2.5	<1.0	15.5	2.5	12.6	22.6
04/Sep/2007	18/Sep/2007	5.4	17.4	11.2	13.9	63.3	14.4	10.2	65.3	4.7	<1.0	9.7	4.3	9.6	21.5
18/Sep/2007	02/Oct/2007	5.0	2.0	0.0	<0.7	<0.9	1.6	2.2	1.2	0.7	2.9	2.1	10.0	-	3.2
02/Oct/2007	30/Oct/2007	6.5	29.9	15.0	139.7	42.8	3.5	1.7	47.9	11.9	30.9	24.8	0.3	22.0	78.4
30/Oct/2007	13/Nov/2007	5.1	63.2	18.0	37.5	362.7	76.9	23.9	391.5	7.1	2.7	19.5	7.2	56.7	35.8
13/Nov/2007	27/Nov/2007	4.6	30.2	33.1	22.9	129.7	27.3	8.0	136.0	2.8	2.8	14.6	25.7	27.7	40.5
27/Nov/2007	11/Dec/2007	-	-	-	-	-	-	-	-	-	-	-	-	-	0.0
11/Dec/2007	02/Jan/2008	5.0	23.4	11.3	13.1	120.4	23.7	7.6	126.3	2.9	<1.0	8.9	10.7	20.8	68.3
			Precipitation-weighted annual means for site(samples containing phosphate are excluded)												
5150			21.4	8.7	13.2	108.5	21.3	7.0	116.4	2.3	0.8	8.3	8.9		Total rainfall 1670.8

# Stoke Ferry

2007

Site Code: 5004  
 Easting: 5700  
 Northing: 2988  
 Latitude: 52 33 36 N  
 Longitude: 00 30 29 E  
 Altitude (m): 15  
 Rainfall (mm): 606  
 [30 year mean 1940 - 1971]

Site Environment:  
 Grassed land at water treatment works

Other measurements:  
 HNO3 Denuder, WF, EMEP, TOMPs

Site Operator:  
 BC of King's Lynn & West Norfolk

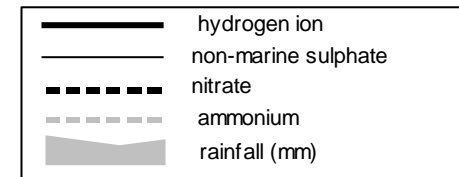
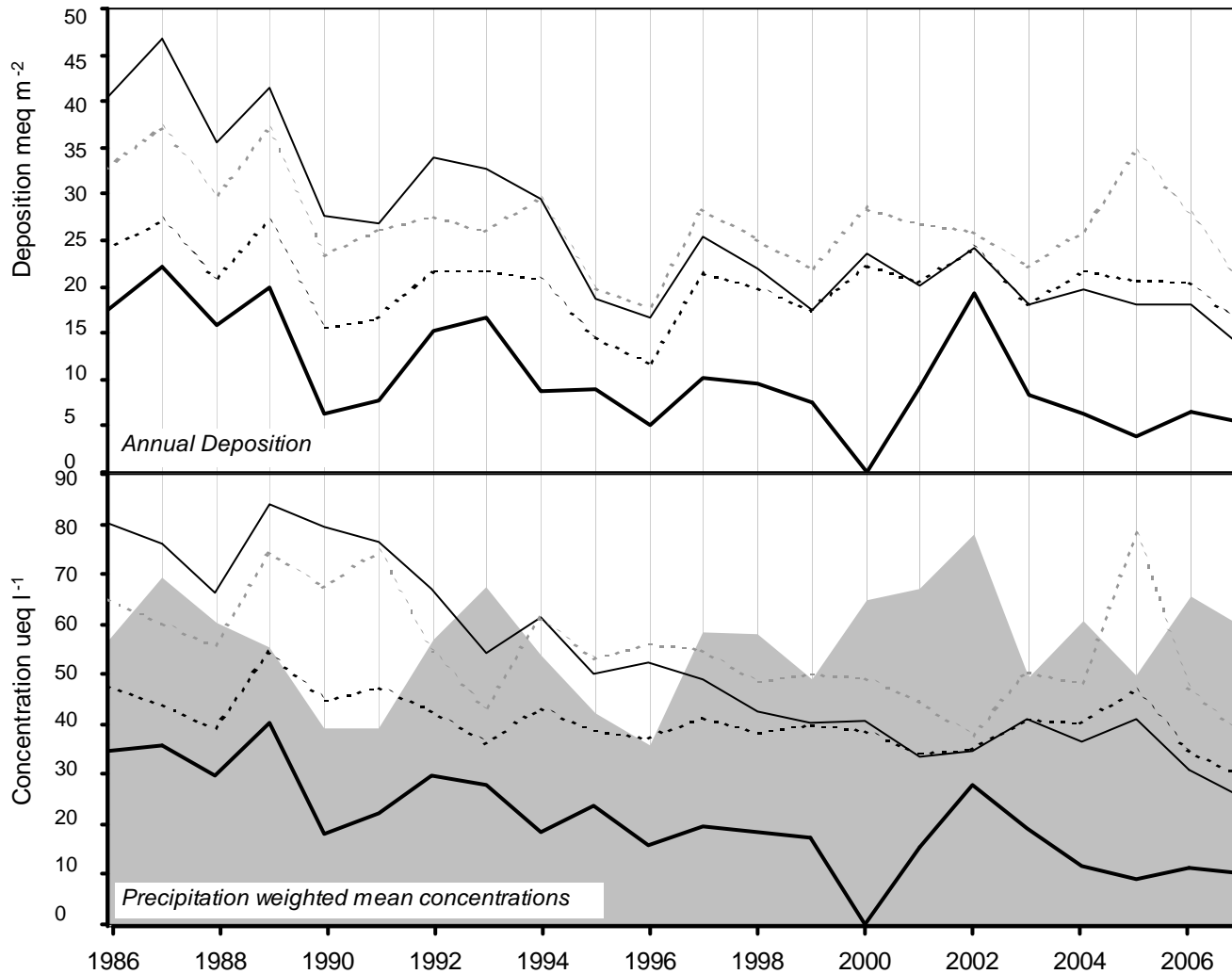

long-term trends in concentration (+x = increase; -x = decrease)	
<i>hydrogen ion</i>	-1.15 ueq/l (-3.46 %/year): 21 years' data +++ Strong trend detected
<i>non-marine sulphate</i>	-2.62 ueq/l (-3.26 %/year): 22 years' data ++++ Very strong trend detected
<i>nitrate</i>	-0.46 ueq/l (-0.99 %/year): 22 years' data + Significant trend detected
<i>ammonium</i>	-0.78 ueq/l (-1.22 %/year): 22 years' data + Significant trend detected



(5004) Stoke Ferry

Start Date	End Date	pH	SO4 (µeq/l)	NO3 (µeq/l)	NH4 (µeq/l)	Na (µeq/l)	Mg (µeq/l)	Ca (µeq/l)	Cl (µeq/l)	K (µeq/l)	PO4 (µeq/l)	Nss SO4 (µeq/l)	H+ (µeq/l)	Conductivity (S/cm)	Rainfall (mm)	
10/Jan/2007	24/Jan/2007	5.7	33.4	17.7	40.9	121.5	21.1	11.6	113.1	6.8	7.5	18.8	1.9	21.4	13.3	
24/Jan/2007	07/Feb/2007	4.7	274.6	119.8	315.7	320.7	56.7	72.8	340.1	36.3	27.8	236.0	20.0	-	1.5	
07/Feb/2007	20/Feb/2007	5.3	34.5	35.9	61.0	55.9	13.1	9.3	58.8	2.4	<1.0	27.8	5.6	19.0	20.5	
20/Feb/2007	07/Mar/2007	5.0	22.8	19.6	28.3	37.8	7.6	8.6	40.3	1.5	<1.0	18.2	9.3	13.3	40.2	
07/Mar/2007	21/Mar/2007	6.2	99.3	19.1	43.2	560.2	110.5	53.5	620.5	11.2	<1.0	31.8	0.7	92.4	13.1	
21/Mar/2007	04/Apr/2007	-	-	-	-	-	-	-	-	-	-	-	-	-	0.0	
04/Apr/2007	18/Apr/2007	-	-	-	-	-	-	-	-	-	-	-	-	-	0.0	
18/Apr/2007	01/May/2007	-	-	-	-	-	-	-	-	-	-	-	-	-	0.0	
01/May/2007	15/May/2007	6.0	22.1	18.9	42.5	28.8	4.6	19.4	26.5	1.3	1.6	18.6	0.9	12.6	44.4	
15/May/2007	30/May/2007	5.4	28.8	28.9	27.6	66.9	15.4	22.4	72.5	2.5	<1.0	20.7	4.3	18.4	51.5	
30/May/2007	13/Jun/2007	5.0	107.6	175.7	207.5	89.0	25.9	213.4	95.9	16.1	34.9	96.9	10.0	-	1.6	
13/Jun/2007	27/Jun/2007	4.7	29.0	35.2	37.1	19.1	4.5	13.0	21.2	2.1	<1.0	26.7	19.5	15.6	67.8	
27/Jun/2007	11/Jul/2007	4.8	14.1	14.2	9.9	10.3	3.4	6.3	12.5	0.7	<1.0	12.8	15.8	8.0	39.1	
11/Jul/2007	25/Jul/2007	5.9	44.5	59.3	54.1	46.2	9.0	53.2	38.3	3.4	<1.0	38.9	1.3	22.4	21.7	
25/Jul/2007	08/Aug/2007	-	-	-	-	-	-	-	-	-	-	-	-	-	0.0	
08/Aug/2007	22/Aug/2007	7.0	221.0	14.9	2122.0	149.4	15.0	50.8	59.5	120.7	377.2	203.0	0.1	341.0	49.4	
22/Aug/2007	04/Sep/2007	4.3	85.3	55.6	55.1	229.9	52.7	40.9	254.9	7.5	<1.0	57.6	46.8	55.2	17.9	
04/Sep/2007	19/Sep/2007	-	-	-	-	-	-	-	-	-	-	-	-	-	0.0	
19/Sep/2007	03/Oct/2007	6.8	53.9	16.3	117.3	197.1	38.2	62.2	230.3	12.1	57.7	30.2	0.2	60.2	26.1	
03/Oct/2007	17/Oct/2007	5.4	18.8	23.7	29.3	9.8	4.0	9.9	9.1	1.3	1.8	17.6	3.7	5.8	56.6	
17/Oct/2007	31/Oct/2007	4.7	140.2	123.4	90.5	147.2	30.2	188.7	128.1	10.8	6.4	122.5	20.0	-	1.6	
31/Oct/2007	14/Nov/2007	5.0	144.5	51.2	108.2	248.1	48.6	162.1	280.4	15.6	6.6	114.6	10.0	-	4.8	
14/Nov/2007	27/Nov/2007	4.8	51.6	56.7	65.2	130.1	27.5	20.5	139.3	3.9	1.9	36.0	15.1	31.9	16.1	
27/Nov/2007	12/Dec/2007	5.0	27.7	15.8	21.5	100.7	21.4	13.7	109.1	3.3	2.2	15.5	10.2	22.5	23.6	
12/Dec/2007	03/Jan/2008	5.0	48.4	29.2	57.7	72.2	14.2	15.0	71.9	2.8	1.2	39.7	9.1	22.5	14.3	
			Precipitation<weighted annual means for site(samples containing phosphate are excluded)													Total rainfall
5004			33.6	29.2	37.1	68.6	14.6	20.0	73.0	2.8	1.2	25.3	10.1		525.2	

# Preston Montford

2007

Site Code: 5023  
 Easting: 3432  
 Northing: 3143  
 Latitude: 52 43 23 N  
 Longitude: 02 50 17 W  
 Altitude (m): 70  
 Rainfall (mm): 695  
 [30 year mean 1940 - 1971]

Site Environment:  
 Field adjacent to Study Centre

Other measurements:  
 Met

Site Operator:  
 Field Studies Council

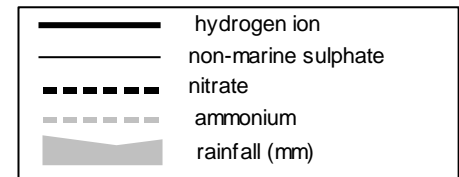

long-term trends in concentration (+x = increase; -x = decrease)	
<i>hydrogen ion</i>	-1.22 ueq/l (-3.98 %/year): 21 years' data ++ Moderately strong trend detected
<i>non-marine sulphate</i>	-2.21 ueq/l (-3.55 %/year): 22 years' data ++++ Very strong trend detected
<i>nitrate</i>	-0.48 ueq/l (-1.54 %/year): 22 years' data + Significant trend detected
<i>ammonium</i>	-0.81 ueq/l (-1.52 %/year): 22 years' data + Significant trend detected

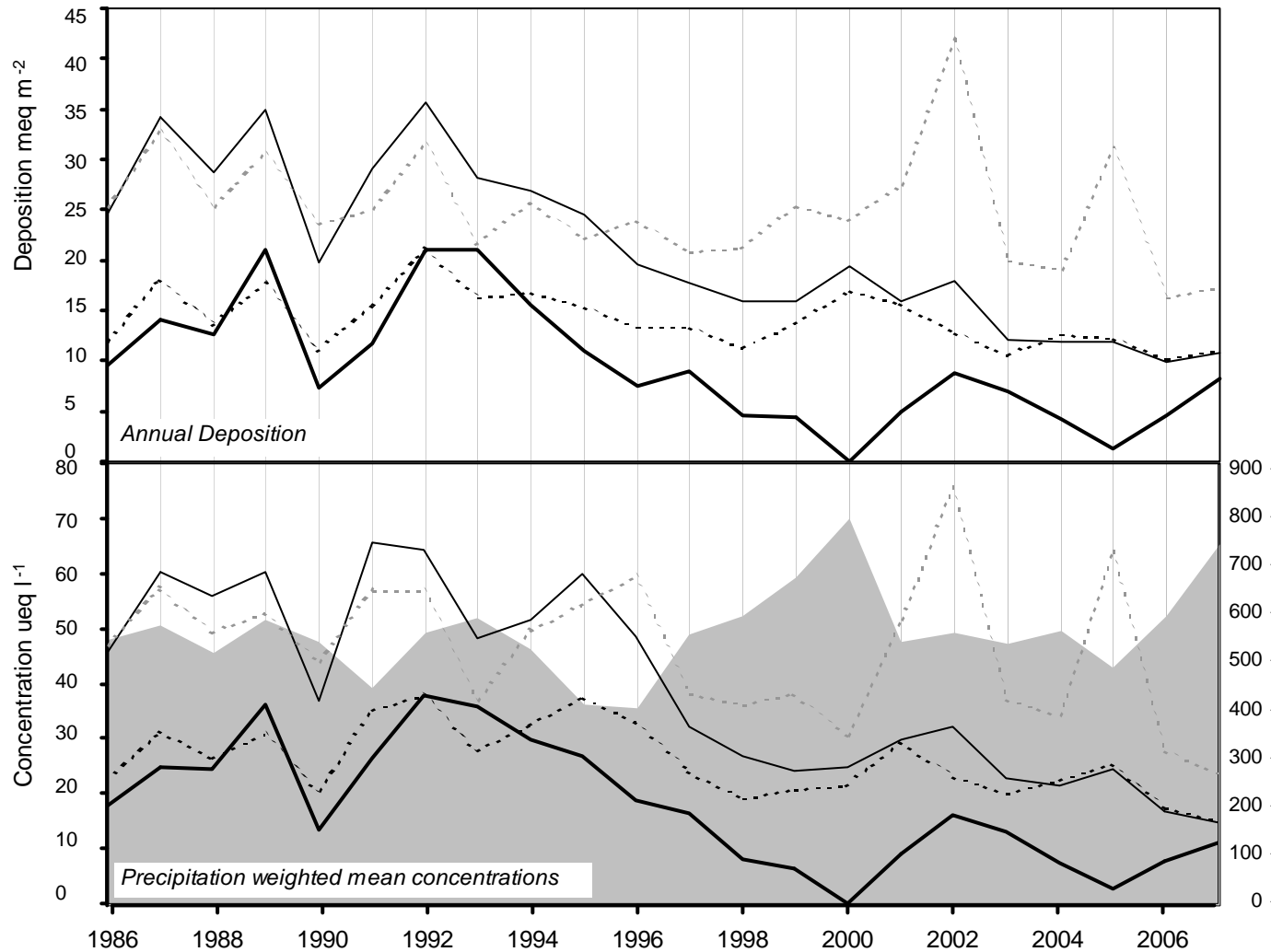

(5023) Preston Montford

Start Date	End Date	pH	SO4 (µeq/l)	NO3 (µeq/l)	NH4 (µeq/l)	Na (µeq/l)	Mg (µeq/l)	Ca (µeq/l)	Cl (µeq/l)	K (µeq/l)	PO4 (µeq/l)	Nss SO4 (µeq/l)	H+ (µeq/l)	Conductivity (S/cm)	Rainfall (mm)
08/Jan/2007	22/Jan/2007	5.9	18.6	2.5	18.8	134.8	19.4	7.1	146.7	4.8	<1.0	2.3	1.3	22.5	47.5
22/Jan/2007	05/Feb/2007	-	-	-	-	-	-	-	-	-	-	-	-	-	0.0
05/Feb/2007	19/Feb/2007	4.5	26.3	30.2	31.9	27.5	5.4	5.3	31.3	1.9	<1.0	22.9	28.8	16.2	41.8
19/Feb/2007	05/Mar/2007	5.4	14.7	8.1	15.8	63.2	10.0	6.0	74.3	1.9	<1.0	7.1	3.9	14.0	19.3
05/Mar/2007	19/Mar/2007	5.8	24.0	4.5	12.9	155.2	27.8	10.0	184.5	6.0	<1.0	5.3	1.5	27.0	14.5
19/Mar/2007	02/Apr/2007	-	-	-	-	-	-	-	-	-	-	-	-	-	0.0
02/Apr/2007	16/Apr/2007	-	-	-	-	-	-	-	-	-	-	-	-	-	0.0
16/Apr/2007	30/Apr/2007	6.1	49.8	34.3	63.9	19.4	5.3	25.7	11.0	6.4	<1.0	47.4	0.9	17.8	10.2
30/Apr/2007	14/May/2007	5.0	10.6	7.8	5.8	8.1	3.2	8.1	9.6	1.3	<1.0	9.6	10.0	6.5	89.8
14/May/2007	28/May/2007	5.9	21.1	16.6	55.7	24.2	2.1	3.2	22.4	8.2	2.7	18.1	1.3	11.5	27.6
28/May/2007	11/Jun/2007	4.7	28.2	23.2	1.5	32.8	10.9	25.1	32.7	4.2	<1.0	24.3	20.9	15.9	7.8
11/Jun/2007	25/Jun/2007	4.7	18.6	19.7	20.7	3.5	1.5	3.9	4.7	1.6	<1.0	18.2	20.0	10.6	100.5
25/Jun/2007	09/Jul/2007	5.3	10.3	3.2	3.3	21.2	3.9	5.0	24.4	5.4	<1.0	7.8	4.9	6.4	38.4
09/Jul/2007	23/Jul/2007	4.8	19.4	19.0	23.7	4.5	1.1	2.2	5.3	1.3	<1.0	18.8	17.0	10.7	145.2
23/Jul/2007	06/Aug/2007	-	-	-	-	-	-	-	-	-	-	-	-	-	20.0
06/Aug/2007	20/Aug/2007	6.0	11.7	13.0	42.4	17.8	2.7	3.3	21.1	8.1	2.4	9.6	1.0	8.8	15.3
20/Aug/2007	03/Sep/2007	-	-	-	-	-	-	-	-	-	-	-	-	-	0.0
03/Sep/2007	17/Sep/2007	6.1	37.8	13.3	30.4	26.3	7.1	44.4	28.8	3.1	<1.0	34.7	0.8	9.5	12.4
17/Sep/2007	27/Sep/2007	-	-	-	-	-	-	-	-	-	-	-	-	-	0.0
27/Sep/2007	03/Oct/2007	6.2	24.1	17.5	52.0	53.1	6.2	7.8	57.7	14.6	<1.0	17.7	0.7	15.9	19.1
03/Oct/2007	16/Oct/2007	5.0	26.7	25.1	61.4	37.9	5.4	6.5	38.4	11.1	3.1	22.1	10.0	-	6.0
16/Oct/2007	12/Nov/2007	6.0	47.2	15.2	42.2	247.2	47.1	25.5	279.9	33.6	<1.0	17.4	1.0	40.9	12.3
12/Nov/2007	24/Nov/2007	4.8	24.2	35.6	38.4	44.9	10.3	8.7	49.0	3.7	1.3	18.8	17.0	16.5	33.4
24/Nov/2007	10/Dec/2007	5.9	16.0	3.1	19.6	101.4	16.2	6.7	110.8	6.8	2.4	3.8	1.2	14.9	41.9
10/Dec/2007	02/Jan/2008	5.7	18.1	10.7	27.5	60.0	9.2	5.8	63.2	3.4	2.3	10.8	2.1	13.2	30.7
		Precipitation<weighted annual means for site(samples containing phosphate are excluded)													Total rainfall
5023			19.4	15.2	23.7	38.1	6.8	6.8	42.2	4.0	0.9	14.8	11.1		733.5

# Bottesford

2007

Site Code: 5121  
 Easting: 4797  
 Northing: 3376  
 Latitude: 52 55 46 N  
 Longitude: 00 48 51 W  
 Altitude (m): 32  
 Rainfall (mm): 561  
 [30 year mean 1940 - 1971]

Site Environment:  
 Rural pasture

Other measurements:  
 SO<sub>2</sub> (PowerGen), ozone (PowerGen)

Site Operator:  
 E.ON

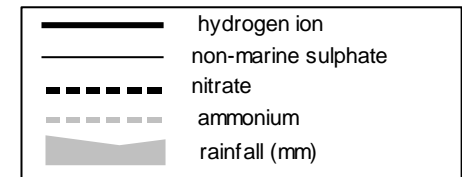
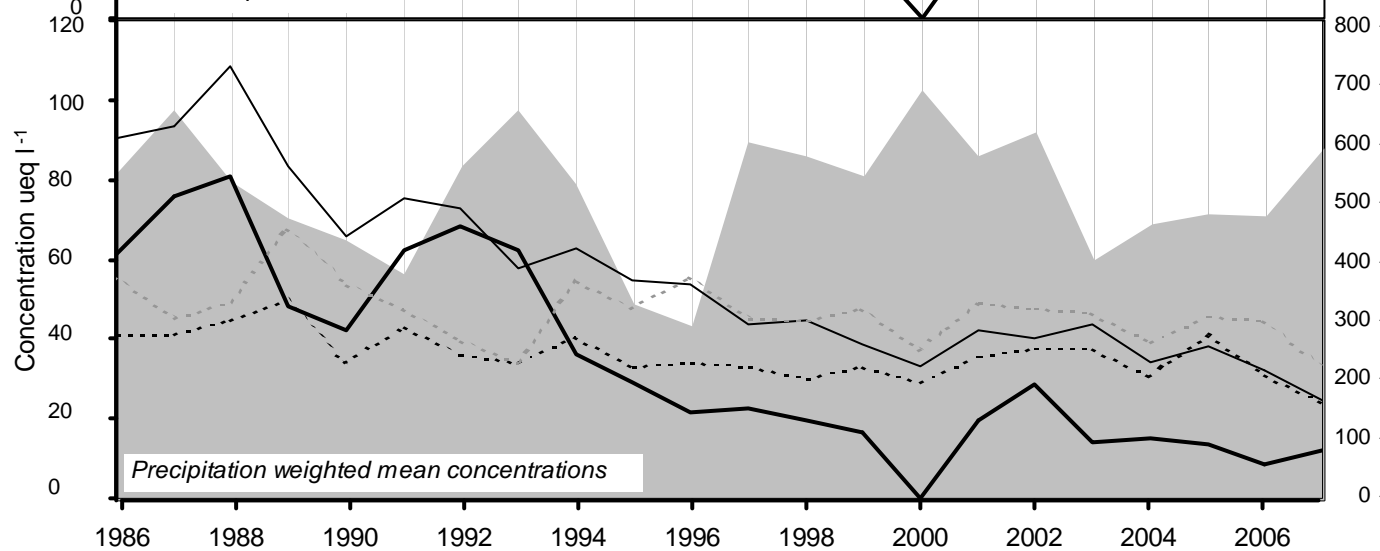
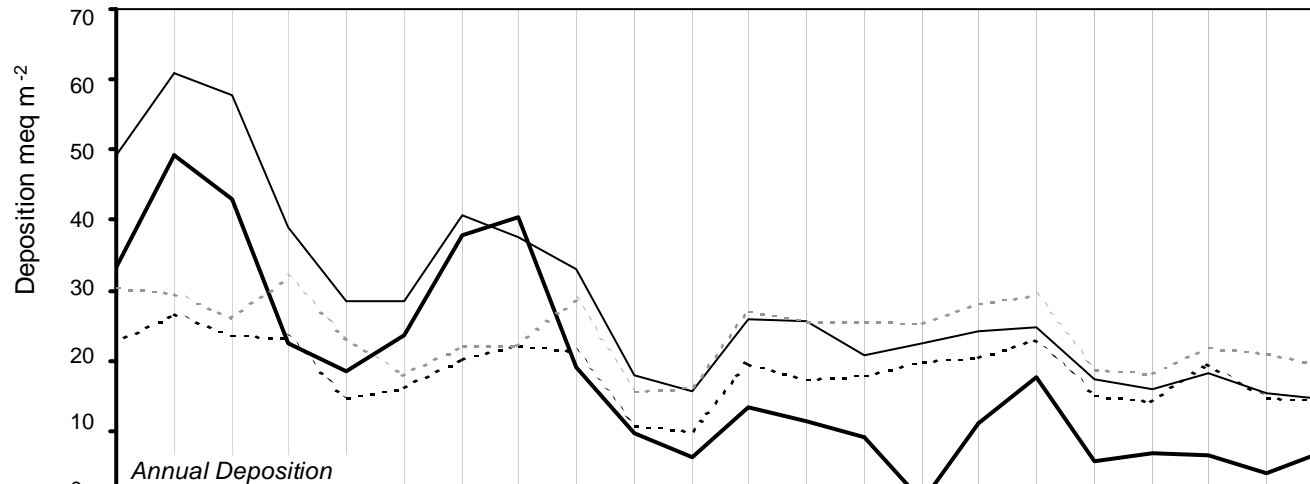

long-term trends in concentration (+x = increase; -x = decrease)	
<i>hydrogen ion</i>	-3.39 ueq/l (-4.86 %/year): 21 years' data +++ Very strong trend detected
<i>non-marine sulphate</i>	-3.24 ueq/l (-3.60 %/year): 22 years' data +++ Very strong trend detected
<i>nitrate</i>	-0.47 ueq/l (-1.13 %/year): 22 years' data ++ Moderately strong trend detected
<i>ammonium</i>	-0.44 ueq/l (-0.84 %/year): 22 years' data - No significant trend detected

### (5121) Bottesford

Start Date	End Date	pH	SO4 (µeq/l)	NO3 (µeq/l)	NH4 (µeq/l)	Na (µeq/l)	Mg (µeq/l)	Ca (µeq/l)	Cl (µeq/l)	K (µeq/l)	PO4 (µeq/l)	Nss SO4 (µeq/l)	H+ (µeq/l)	Conductivity (S/cm)	Rainfall (mm)
03/Jan/2007	06/Feb/2007	5.1	31.4	12.7	31.0	89.8	16.5	9.5	98.0	2.7	<1.0	20.6	8.5	20.2	36.4
06/Feb/2007	21/Feb/2007	4.6	35.3	40.8	50.6	46.3	10.2	13.1	51.0	2.2	<1.0	29.7	26.3	21.9	27.2
21/Feb/2007	06/Mar/2007	5.0	18.0	15.1	22.6	31.9	7.0	6.3	34.7	1.2	<1.0	14.1	9.1	11.3	43.2
06/Mar/2007	20/Mar/2007	6.4	67.9	31.5	59.3	152.8	25.0	15.7	219.8	5.0	4.5	49.5	0.4	43.9	5.5
20/Mar/2007	03/Apr/2007	4.7	360.8	249.7	492.6	257.8	65.3	149.4	284.1	17.4	5.4	329.7	20.0	-	2.1
03/Apr/2007	18/Apr/2007	-	-	-	-	-	-	-	-	-	-	-	-	-	0.0
18/Apr/2007	10/May/2007	6.1	43.1	38.9	69.4	33.0	11.5	45.6	33.1	7.1	<1.0	39.1	0.9	22.9	15.0
10/May/2007	29/May/2007	5.0	25.6	20.9	31.0	22.8	5.3	6.6	26.7	1.6	<1.0	22.9	11.2	12.6	88.2
29/May/2007	21/Jun/2007	4.9	39.3	45.1	52.1	13.0	8.3	21.8	14.1	3.1	1.2	37.7	12.9	16.5	64.8
21/Jun/2007	05/Jul/2007	5.1	14.2	9.4	12.7	4.6	3.3	4.9	6.4	0.6	<1.0	13.6	8.7	5.9	133.2
05/Jul/2007	15/Aug/2007	5.4	22.9	19.5	30.9	16.9	4.3	20.9	18.7	3.0	<1.0	20.9	4.5	9.0	66.2
15/Aug/2007	05/Sep/2007	4.5	39.7	19.9	13.2	11.4	5.5	28.8	11.3	1.9	<1.0	38.4	33.1	12.2	25.6
05/Sep/2007	18/Sep/2007	-	-	-	-	-	-	-	-	-	-	-	-	-	0.0
18/Sep/2007	09/Oct/2007	-	-	-	-	-	-	-	-	-	-	-	-	-	0.0
09/Oct/2007	31/Oct/2007	4.4	45.5	50.9	47.1	52.4	14.6	26.2	49.9	2.9	<1.0	39.2	39.8	-	8.4
31/Oct/2007	20/Nov/2007	4.7	28.2	34.1	27.3	56.3	13.7	18.8	60.4	2.8	<1.0	21.4	20.0	16.9	26.6
20/Nov/2007	06/Dec/2007	4.7	37.0	32.0	37.0	87.4	17.8	16.0	93.1	4.3	<1.0	26.5	21.4	25.2	14.9
06/Dec/2007	18/Dec/2007	5.6	17.6	10.6	28.0	45.8	8.0	7.8	46.5	2.8	1.2	12.1	2.3	9.3	6.4
18/Dec/2007	11/Jan/2008	4.9	49.6	44.8	60.8	112.3	21.8	15.7	114.5	4.1	2.1	36.1	13.8	30.0	22.7
			Precipitation-weighted annual means for site (samples containing phosphate are excluded)												
5121			28.6	24.2	32.9	32.0	8.2	14.0	35.3	2.3	0.7	24.8	12.1		Total rainfall 586.3

# Llyn Llgi

2007

Site Code: 5160  
 Easting: 2647  
 Northing: 3483  
 Latitude: 53 01 48 N  
 Longitude: 04 01 82 W  
 Altitude (m): 380  
 Rainfall (mm): 2588

[30 year mean 1940 - 1971]

Site Environment:  
**Grassland and moorland**

Other measurements:  
**UKAWMN, Lakewater chemistry.**

Site Operator:  
**Centre for Ecology and Hydrology (Bangor)**

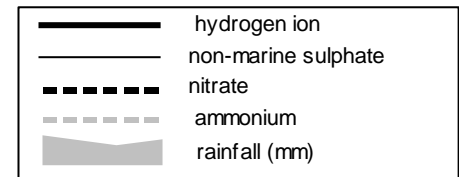
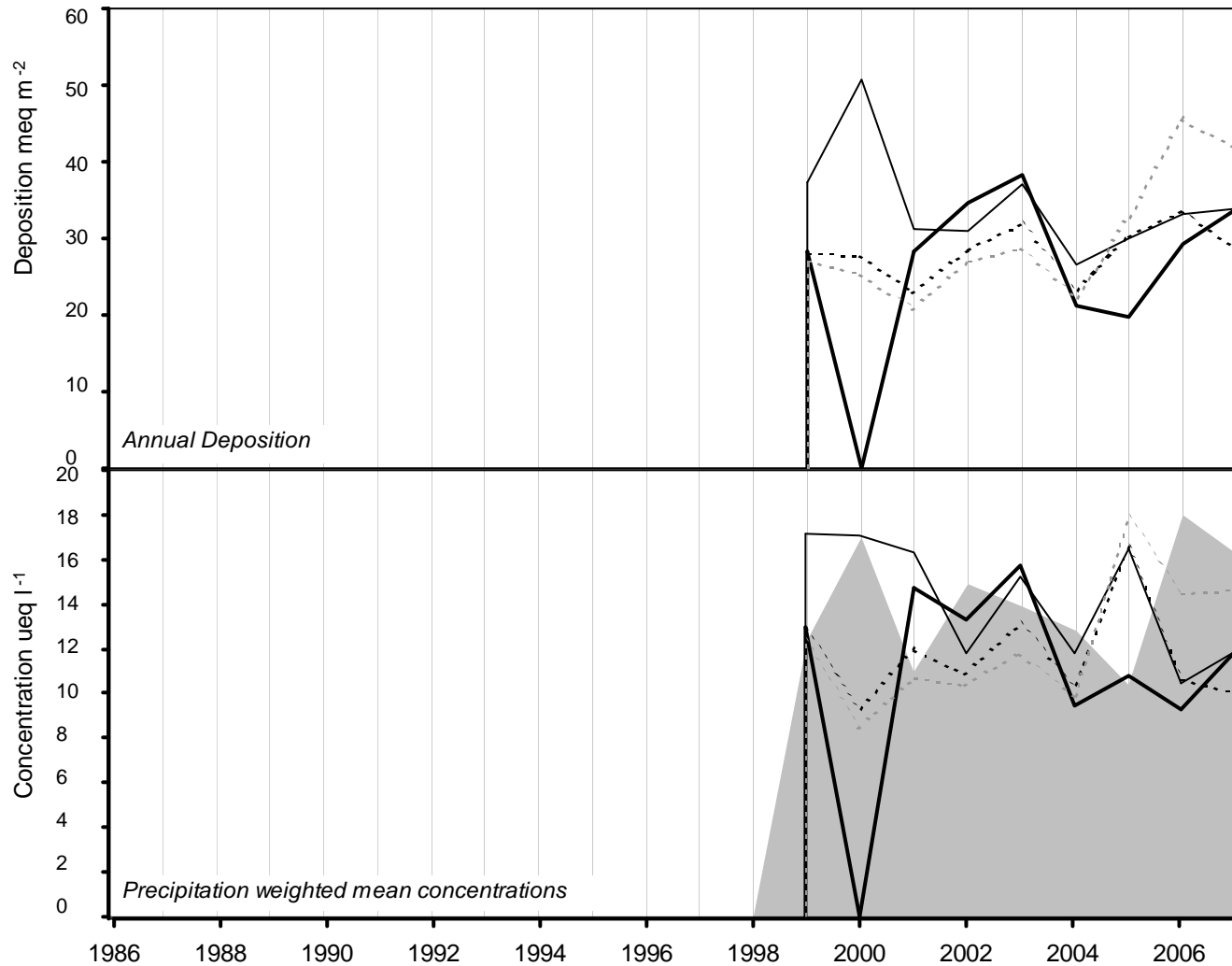

long-term trends in concentration (+x = increase; -x = decrease)	
<i>hydrogen ion</i>	-0.80 ueq/l (-3.18 %/year): 8 years' data - No significant trend detected
<i>non-marine sulphate</i>	-0.67 ueq/l (-2.62 %/year): 9 years' data + Significant trend detected
<i>nitrate</i>	0.06 ueq/l (0.58 %/year): 9 years' data - No significant trend detected
<i>ammonium</i>	0.67 ueq/l (75.80 %/year): 9 years' data - No significant trend detected

(5160) Llyn Llagi

Start Date	End Date	pH	SO4 (µeq/l)	NO3 (µeq/l)	NH4 (µeq/l)	Na (µeq/l)	Mg (µeq/l)	Ca (µeq/l)	Cl (µeq/l)	K (µeq/l)	PO4 (µeq/l)	Nss SO4 (µeq/l)	H+ (µeq/l)	Conductivity (S/cm)	Rainfall (mm)
08/Jan/2007	22/Jan/2007	5.3	47.7	5.7	12.1	454.7	88.6	21.7	444.6	5.5	<1.0	0.0	4.9	59.4	298.1
22/Jan/2007	07/Feb/2007	5.9	28.0	15.4	42.8	96.3	15.5	5.1	108.6	2.1	<1.0	16.4	1.4	20.5	21.7
07/Feb/2007	22/Feb/2007	4.9	18.5	9.9	10.1	123.5	25.0	7.6	133.8	2.8	<1.0	3.6	12.6	22.8	101.7
22/Feb/2007	08/Mar/2007	5.4	26.3	6.3	14.1	175.3	34.9	9.7	196.9	3.7	<1.0	5.2	4.3	28.4	174.1
08/Mar/2007	19/Mar/2007	5.3	35.1	13.1	18.6	181.4	35.1	12.9	193.7	3.4	<1.0	13.2	5.1	30.3	86.4
19/Mar/2007	02/Apr/2007	5.2	32.5	25.7	21.4	174.3	34.2	18.0	181.6	4.7	<1.0	11.5	5.8	30.8	5.9
02/Apr/2007	16/Apr/2007	-	-	-	-	-	-	-	-	-	-	-	-	-	0.0
16/Apr/2007	15/May/2007	5.1	28.7	12.4	31.9	37.0	7.1	5.6	40.9	2.7	4.1	24.2	7.4	13.3	274.3
15/May/2007	30/May/2007	5.2	22.8	10.6	16.3	77.9	13.4	7.5	82.8	2.0	<1.0	13.5	6.8	16.3	83.4
30/May/2007	11/Jun/2007	5.2	22.8	20.5	16.9	50.6	9.9	17.0	54.1	3.2	<1.0	16.7	5.9	14.7	4.8
11/Jun/2007	26/Jun/2007	4.7	20.2	17.1	15.4	25.5	5.0	3.2	28.2	1.1	<1.0	17.1	20.4	13.4	121.3
26/Jun/2007	09/Jul/2007	4.8	18.0	5.0	4.7	78.2	15.0	4.3	93.2	1.6	<1.0	8.6	15.1	16.4	235.0
09/Jul/2007	24/Jul/2007	4.7	13.3	11.4	8.4	15.9	2.6	1.5	16.5	0.6	<1.0	11.4	21.4	10.3	205.2
24/Jul/2007	06/Aug/2007	-	-	-	-	-	-	-	-	-	-	-	-	-	0.0
06/Aug/2007	21/Aug/2007	4.5	15.2	9.0	5.1	42.6	9.3	4.6	50.7	1.3	<1.0	10.1	33.1	10.2	148.8
21/Aug/2007	03/Sep/2007	5.6	22.0	14.7	41.2	37.6	6.2	10.2	38.5	2.1	<1.0	17.5	2.4	10.0	29.1
03/Sep/2007	18/Sep/2007	5.4	37.7	21.7	26.6	188.5	43.8	18.7	201.4	4.4	<1.0	15.0	3.8	28.0	29.5
18/Sep/2007	02/Oct/2007	6.4	20.4	4.7	14.5	88.8	19.1	9.2	106.6	3.1	5.8	9.7	0.4	14.1	182.7
02/Oct/2007	29/Oct/2007	5.4	25.7	16.6	33.8	49.8	9.5	7.1	50.3	2.1	2.8	19.7	4.2	9.7	176.0
29/Oct/2007	12/Nov/2007	5.5	52.9	15.2	34.0	312.3	64.2	23.3	342.7	6.4	2.8	15.3	3.1	48.1	40.8
12/Nov/2007	26/Nov/2007	4.5	34.7	29.8	18.8	153.2	31.0	15.2	161.7	3.3	2.9	16.2	31.6	35.2	66.2
26/Nov/2007	10/Dec/2007	4.8	23.3	3.6	<0.7	154.4	32.3	10.4	170.6	3.6	<1.0	4.7	16.2	29.0	319.4
10/Dec/2007	21/Dec/2007	-	-	-	-	-	-	-	-	-	-	-	-	-	0.0
21/Dec/2007	07/Jan/2008	4.8	28.5	13.1	12.0	155.4	31.4	9.6	165.5	3.4	<1.0	9.7	14.8	27.0	245.1
5160			26.3	10.0	14.6	135.9	27.0	9.2	144.0	2.9	1.4	11.9	11.9		Total rainfall 2849.6

# Llyn Llydaw

2007

Site Code: 5153  
 Easting: 2638  
 Northing: 3549  
 Latitude: 53 04 35 N  
 Longitude: 04 01 42 W  
 Altitude (m): 490  
 Rainfall (mm): 4536  
 [30 year mean 1940 - 1971]

Site Environment:  
 Very open moorland in Snowdon Horseshoe

Other measurements:  
 DT

Site Operator:  
 Countryside Council for Wales

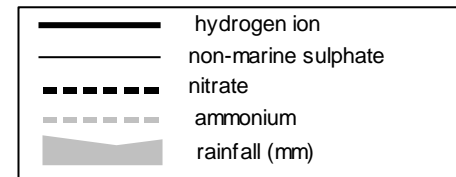

long-term trends in concentration (+x = increase; -x = decrease)	
<i>hydrogen ion</i>	-0.33 ueq/l (-1.99 %/year): 21 years' data ++ Moderately strong trend detected
<i>non-marine sulphate</i>	-1.17 ueq/l (-3.69 %/year): 22 years' data +++ Strong trend detected
<i>nitrate</i>	-0.20 ueq/l (-1.42 %/year): 22 years' data + Significant trend detected
<i>ammonium</i>	-0.11 ueq/l (-0.84 %/year): 22 years' data - No significant trend detected

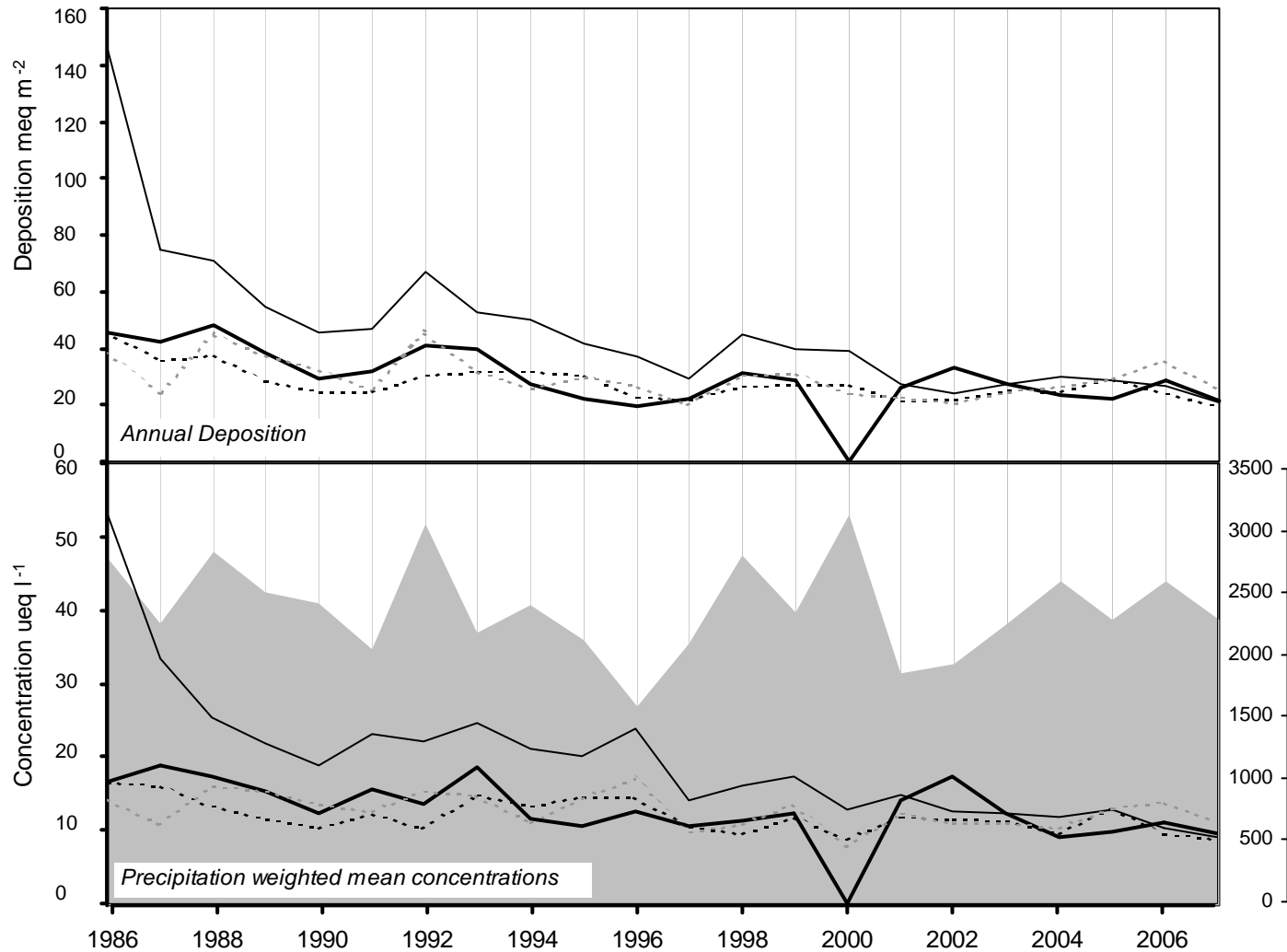



(5153) Llyn Llydaw

Start Date	End Date	pH	SO4 (µeq/l)	NO3 (µeq/l)	NH4 (µeq/l)	Na (µeq/l)	Mg (µeq/l)	Ca (µeq/l)	Cl (µeq/l)	K (µeq/l)	PO4 (µeq/l)	Nss SO4 (µeq/l)	H+ (µeq/l)	Conductivity (S/cm)	Rainfall (mm)
03/Jan/2007	24/Jan/2007	5.3	25.9	3.9	9.9	195.3	39.9	9.7	208.0	3.7	<1.0	2.3	5.5	30.6	144.4
24/Jan/2007	07/Feb/2007	4.7	57.2	34.9	109.2	318.7	60.8	23.4	255.5	12.6	<1.0	18.8	20.0	-	2.0
07/Feb/2007	21/Feb/2007	4.8	16.4	9.3	9.1	86.4	17.0	5.3	92.0	1.7	<1.0	6.0	14.8	17.8	114.2
21/Feb/2007	07/Mar/2007	5.2	17.0	6.1	8.9	103.5	17.6	5.3	108.8	2.2	<1.0	4.5	6.2	18.2	171.0
07/Mar/2007	21/Mar/2007	5.4	24.9	11.2	19.2	100.4	20.2	6.9	105.9	2.0	<1.0	12.8	4.1	18.4	52.4
21/Mar/2007	04/Apr/2007	4.7	68.7	64.5	80.6	72.5	19.8	32.8	76.2	4.3	<1.0	59.9	19.1	31.0	5.9
04/Apr/2007	18/Apr/2007	-	-	-	-	-	-	-	-	-	-	-	-	-	0.0
18/Apr/2007	02/May/2007	5.0	18.2	9.8	17.2	5.4	2.3	5.5	6.7	0.6	<1.0	17.5	10.7	7.6	103.3
02/May/2007	16/May/2007	5.3	16.6	7.7	17.3	65.5	12.6	6.6	59.2	1.4	<1.0	8.7	4.6	12.8	117.7
16/May/2007	30/May/2007	5.1	18.6	11.4	14.4	47.8	9.3	6.7	50.6	1.6	<1.0	12.9	8.7	13.1	40.1
30/May/2007	13/Jun/2007	4.8	44.1	51.0	59.4	13.4	4.1	13.6	16.1	2.6	<1.0	42.4	14.8	17.5	18.4
13/Jun/2007	27/Jun/2007	4.8	16.8	13.2	10.5	31.1	6.1	2.3	38.8	0.8	<1.0	13.1	17.0	11.2	169.2
27/Jun/2007	11/Jul/2007	5.0	17.4	4.9	6.3	55.3	10.2	3.8	68.3	1.0	<1.0	10.8	10.0	12.4	288.3
11/Jul/2007	25/Jul/2007	4.7	15.5	14.3	9.8	15.0	3.0	4.8	16.4	1.4	<1.0	13.7	22.4	7.3	7.7
25/Jul/2007	08/Aug/2007	5.0	12.5	5.9	8.9	35.8	6.9	6.6	37.0	1.3	<1.0	8.2	11.0	6.5	130.5
08/Aug/2007	22/Aug/2007	5.2	12.8	6.2	8.9	29.5	4.9	6.6	31.4	2.5	<1.0	9.2	6.0	5.0	130.9
22/Aug/2007	05/Sep/2007	5.8	17.9	12.3	38.6	24.2	3.5	3.3	29.4	1.8	<1.0	15.0	1.5	7.4	39.9
05/Sep/2007	19/Sep/2007	5.4	17.3	7.8	12.7	99.7	17.3	6.0	97.6	2.3	<1.0	5.3	4.3	14.2	61.9
19/Sep/2007	03/Oct/2007	-	-	-	-	-	-	-	-	-	-	-	-	-	0.0
03/Oct/2007	17/Oct/2007	4.8	23.7	17.6	20.7	35.2	9.5	5.8	36.4	1.8	1.6	19.5	14.8	10.8	67.4
17/Oct/2007	31/Oct/2007	5.1	10.8	7.3	6.5	38.4	7.1	3.9	38.9	1.4	<1.0	6.1	7.6	6.9	70.3
31/Oct/2007	14/Nov/2007	5.0	36.3	12.5	32.8	205.3	38.9	16.3	211.5	5.1	2.8	11.6	10.0	-	16.5
14/Nov/2007	28/Nov/2007	4.6	26.2	26.4	17.2	85.0	18.5	8.9	87.1	2.0	<1.0	16.0	28.2	22.3	77.0
28/Nov/2007	12/Dec/2007	5.4	23.4	2.4	2.8	173.6	33.3	8.3	194.9	3.1	<1.0	2.5	4.4	25.3	232.4
12/Dec/2007	02/Jan/2008	5.0	19.0	9.6	7.6	103.0	21.3	8.7	106.6	2.5	1.2	6.6	9.5	19.4	192.0
		Precipitation<weighted annual means for site(samples containing phosphate are excluded)													Total rainfall
5153			19.0	8.7	11.2	82.0	16.0	6.4	88.5	2.0	0.6	9.1	9.5		2253.2

# Wardlow Hay Cop

2007

Site Code: 5120  
 Easting: 4177  
 Northing: 3739  
 Latitude: 53 55 41 N  
 Longitude: 01 44 05 W  
 Altitude (m): 350  
 Rainfall (mm): 811  
 [30 year mean 1940 - 1971]

Site Environment:  
 Open moorland

Other measurements:  
 DT, Met

Site Operator:  
 Natural England

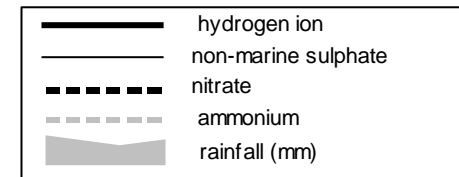
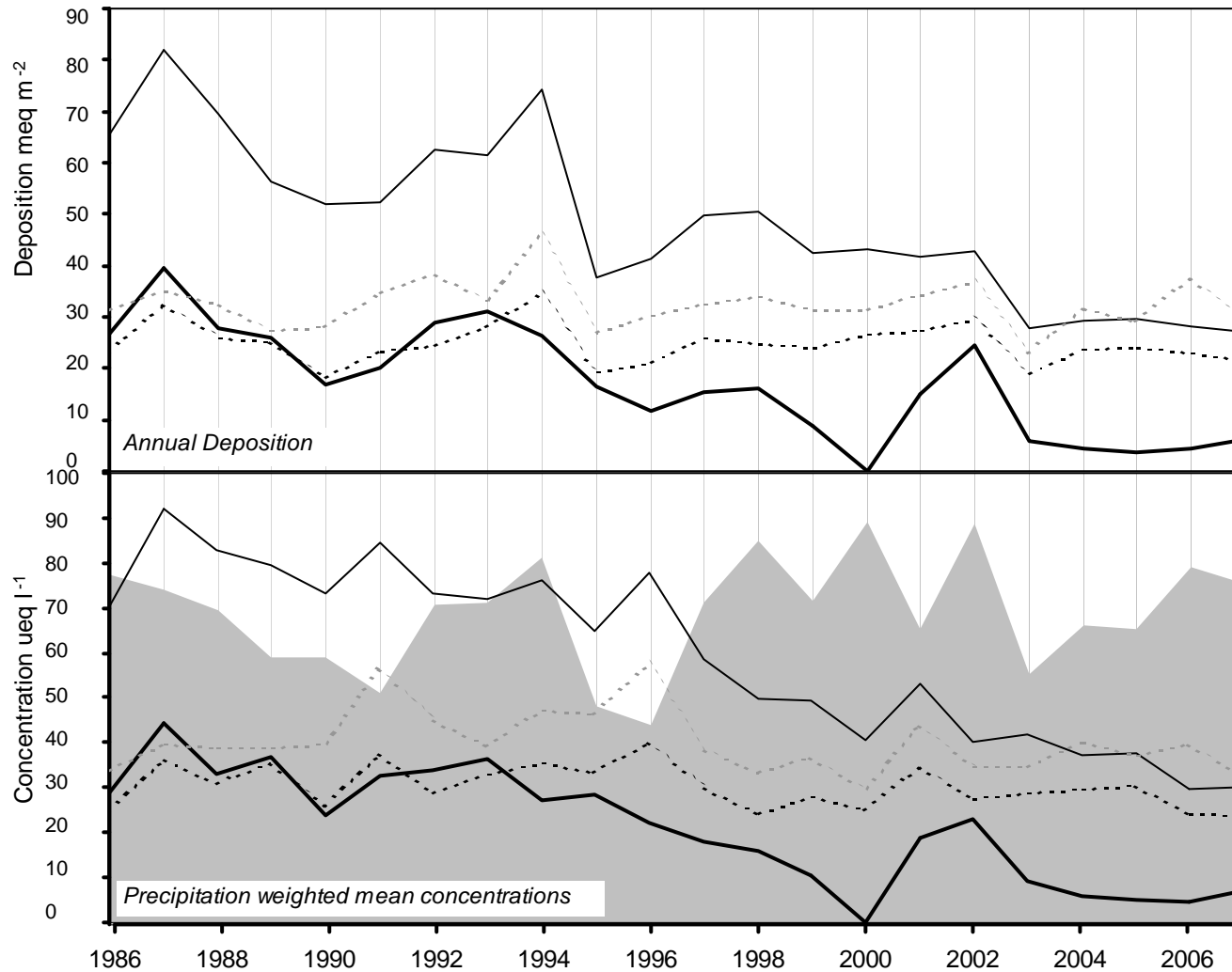

long-term trends in concentration (+x = increase; -x = decrease)	
<i>hydrogen ion</i>	-1.77 ueq/l (-4.45 %/year): 21 years' data ++++ Very strong trend detected
<i>non-marine sulphate</i>	-2.79 ueq/l (-3.13 %/year): 22 years' data ++++ Very strong trend detected
<i>nitrate</i>	-0.28 ueq/l (-0.83 %/year): 22 years' data - No significant trend detected
<i>ammonium</i>	-0.22 ueq/l (-0.52 %/year): 22 years' data - No significant trend detected

### (5120) Wardlow Hay Cop

Start Date	End Date	pH	SO4 (µeq/l)	NO3 (µeq/l)	NH4 (µeq/l)	Na (µeq/l)	Mg (µeq/l)	Ca (µeq/l)	Cl (µeq/l)	K (µeq/l)	PO4 (µeq/l)	Nss SO4 (µeq/l)	H+ (µeq/l)	Conductivity (S/cm)	Rainfall (mm)
07/Jan/2007	21/Jan/2007	6.0	32.7	6.0	16.0	161.3	29.9	15.6	169.0	2.0	<1.0	13.3	1.0	25.1	93.3
21/Jan/2007	04/Feb/2007	6.2	21.5	5.6	80.9	207.7	38.5	42.2	57.9	8.0	<1.0	0.0	0.6	47.6	11.6
04/Feb/2007	18/Feb/2007	4.8	38.0	36.8	40.2	47.3	10.9	26.3	52.5	1.8	<1.0	32.3	14.5	20.4	41.1
18/Feb/2007	18/Mar/2007	5.9	37.4	20.2	30.5	117.7	22.5	25.9	128.6	3.0	<1.0	23.2	1.2	26.4	81.0
18/Mar/2007	01/Apr/2007	4.7	156.0	127.3	182.1	218.6	53.5	158.2	200.0	11.5	4.3	129.6	20.0	-	9.1
01/Apr/2007	15/Apr/2007	-	-	-	-	-	-	-	-	-	-	-	-	-	0.0
15/Apr/2007	29/Apr/2007	6.3	75.0	67.1	109.9	15.6	6.9	99.5	15.4	3.0	1.9	73.1	0.5	29.5	11.8
29/Apr/2007	20/May/2007	5.8	34.2	19.7	27.9	33.2	9.3	49.1	29.7	1.5	<1.0	30.2	1.5	14.4	61.9
20/May/2007	03/Jun/2007	5.7	51.2	34.0	42.2	72.3	16.0	57.6	75.8	2.9	2.0	42.5	1.8	23.8	21.1
03/Jun/2007	17/Jun/2007	4.6	33.6	26.8	17.1	1.5	2.3	20.2	4.0	1.2	<1.0	33.4	24.0	13.4	68.7
17/Jun/2007	01/Jul/2007	4.8	21.3	18.9	15.0	6.6	3.6	8.5	9.7	1.1	<1.0	20.5	14.5	8.8	100.0
01/Jul/2007	15/Jul/2007	5.4	23.5	8.4	14.1	16.4	3.4	17.7	18.9	1.4	<1.0	21.5	3.6	8.4	84.5
15/Jul/2007	29/Jul/2007	5.2	24.4	20.8	23.5	15.8	4.1	15.5	15.2	1.8	<1.0	22.5	5.9	9.8	46.0
29/Jul/2007	15/Aug/2007	6.0	36.9	22.3	27.0	40.2	9.1	68.2	46.1	4.3	<1.0	32.1	1.0	16.5	21.2
15/Aug/2007	26/Aug/2007	5.8	31.1	16.9	37.9	31.5	3.7	14.5	24.6	2.7	2.1	27.3	1.5	8.6	10.2
26/Aug/2007	02/Sep/2007	-	-	-	-	-	-	-	-	-	-	-	-	-	0.0
02/Sep/2007	16/Sep/2007	4.7	137.1	93.9	84.3	159.0	38.5	276.3	166.9	11.3	<1.0	117.9	20.0	-	1.6
16/Sep/2007	30/Sep/2007	6.4	38.8	14.3	43.2	44.3	7.9	27.8	54.9	2.6	<1.0	33.4	0.4	14.6	33.7
30/Sep/2007	21/Oct/2007	5.3	77.8	83.3	84.1	33.3	10.4	66.1	32.3	2.8	1.4	73.8	5.0	25.8	21.1
21/Oct/2007	28/Oct/2007	4.7	45.2	30.2	49.5	50.1	9.6	34.9	43.0	9.1	<1.0	39.2	20.0	-	2.6
28/Oct/2007	11/Nov/2007	6.4	92.5	20.4	59.5	356.7	70.7	82.0	388.5	8.8	2.8	49.6	0.4	62.6	17.7
11/Nov/2007	25/Nov/2007	4.8	32.1	40.4	43.4	40.6	8.9	17.2	41.4	1.8	<1.0	27.2	15.1	16.8	32.8
25/Nov/2007	09/Dec/2007	5.1	22.9	6.3	11.1	76.4	16.5	15.5	84.0	2.3	16.4	13.7	7.4	16.7	100.3
09/Dec/2007	23/Dec/2007	6.8	363.1	220.1	277.3	241.0	89.6	317.5	250.8	45.3	7.2	334.0	0.2	126.4	2.8
23/Dec/2007	06/Jan/2008	5.3	34.8	27.2	43.4	75.7	15.4	15.9	81.0	3.4	2.1	25.7	5.2	19.3	29.2
		Precipitation<weighted annual means for site(samples containing phosphate are excluded)													Total rainfall
5120			37.4	24.0	32.4	64.6	13.7	30.2	66.6	2.5	0.8	30.1	7.1		903.2

# Driby

2007

Site Code: 5136  
 Easting: 5386  
 Northing: 3744  
 Latitude: 53 14 54 N  
 Longitude: 00 04 39 E  
 Altitude (m): 47  
 Rainfall (mm): 579  
 [30 year mean 1940 - 1971]

Site Environment:  
**Sheep pasture**

Other measurements:  
**DT, Met**

Site Operator:  
**Anglian Water**

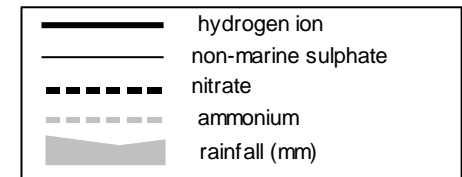
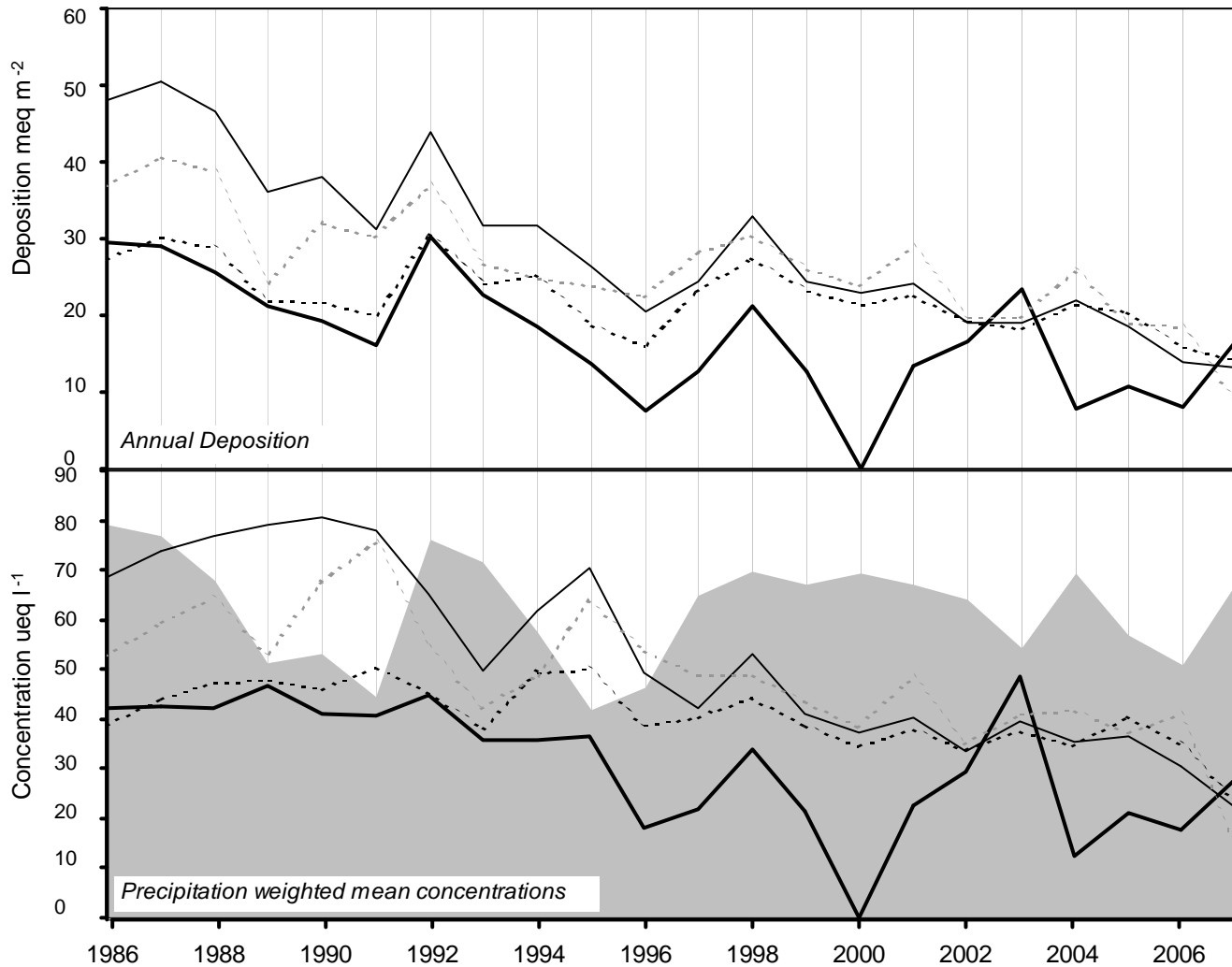

long-term trends in concentration (+x = increase; -x = decrease)	
<i>hydrogen ion</i>	-1.35 ueq/l (-2.97 %/year): 21 years' data ++ Moderately strong trend detected
<i>non-marine sulphate</i>	-2.62 ueq/l (-3.26 %/year): 22 years' data ++++ Very strong trend detected
<i>nitrate</i>	-0.57 ueq/l (-1.20 %/year): 22 years' data ++ Moderately strong trend detected
<i>ammonium</i>	-1.23 ueq/l (-1.95 %/year): 22 years' data +++ Strong trend detected

(5136) Driby

Start Date	End Date	pH	SO4 (µeq/l)	NO3 (µeq/l)	NH4 (µeq/l)	Na (µeq/l)	Mg (µeq/l)	Ca (µeq/l)	Cl (µeq/l)	K (µeq/l)	PO4 (µeq/l)	Nss SO4 (µeq/l)	H+ (µeq/l)	Conductivity (S/cm)	Rainfall (mm)
17/Jan/2007	22/Jan/2007	5.5	21.9	6.9	14.4	102.2	19.0	8.6	108.1	2.1	<1.0	9.6	3.0	17.8	7.3
22/Jan/2007	19/Feb/2007	4.3	48.4	48.5	40.5	113.6	26.7	13.9	129.2	3.0	<1.0	34.7	49.0	36.0	46.3
19/Feb/2007	06/Mar/2007	4.7	28.9	29.5	26.4	54.2	12.3	9.8	58.7	1.9	<1.0	22.3	19.1	18.3	33.6
06/Mar/2007	02/Apr/2007	5.3	93.2	55.0	82.6	320.3	75.0	45.6	357.3	8.5	<1.0	54.6	5.4	66.1	22.3
02/Apr/2007	26/Apr/2007	7.2	120.3	84.9	110.5	198.2	49.7	129.2	215.2	12.7	9.9	96.5	0.1	59.1	4.5
26/Apr/2007	15/Jun/2007	4.4	38.9	28.7	14.1	112.8	25.6	18.5	121.5	2.1	<1.0	25.4	40.7	30.8	141.9
15/Jun/2007	09/Jul/2007	4.6	14.3	12.2	<0.7	13.8	4.0	4.8	18.0	0.8	<1.0	12.7	27.5	11.6	182.2
09/Jul/2007	04/Oct/2007	4.8	31.9	20.2	11.2	81.6	19.2	21.5	88.6	2.9	<1.0	22.1	17.0	19.9	163.6
			Precipitation<weighted annual means for site(samples containing phosphate are excluded)												
5136			31.5	23.6	14.4	78.4	18.3	15.2	86.6	2.2	0.5	22.1	27.8	Total rainfall 601.5	

# River Etherow

2007

Site Code: 5158  
 Easting: 4125  
 Northing: 3986  
 Latitude: 53 48 39 N  
 Longitude: 01 81 31 W  
 Altitude (m): 485  
 Rainfall (mm): 1633  
 [30 year mean 1940 - 1971]

Site Environment:  
**Moorland**

Other measurements:  
**UKAWMN. Streamwater and soil chemistry**

Site Operator:  
**ENSIS**

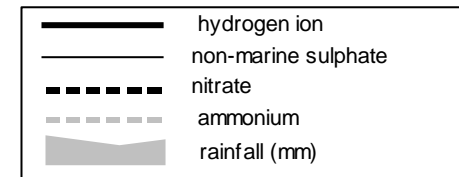
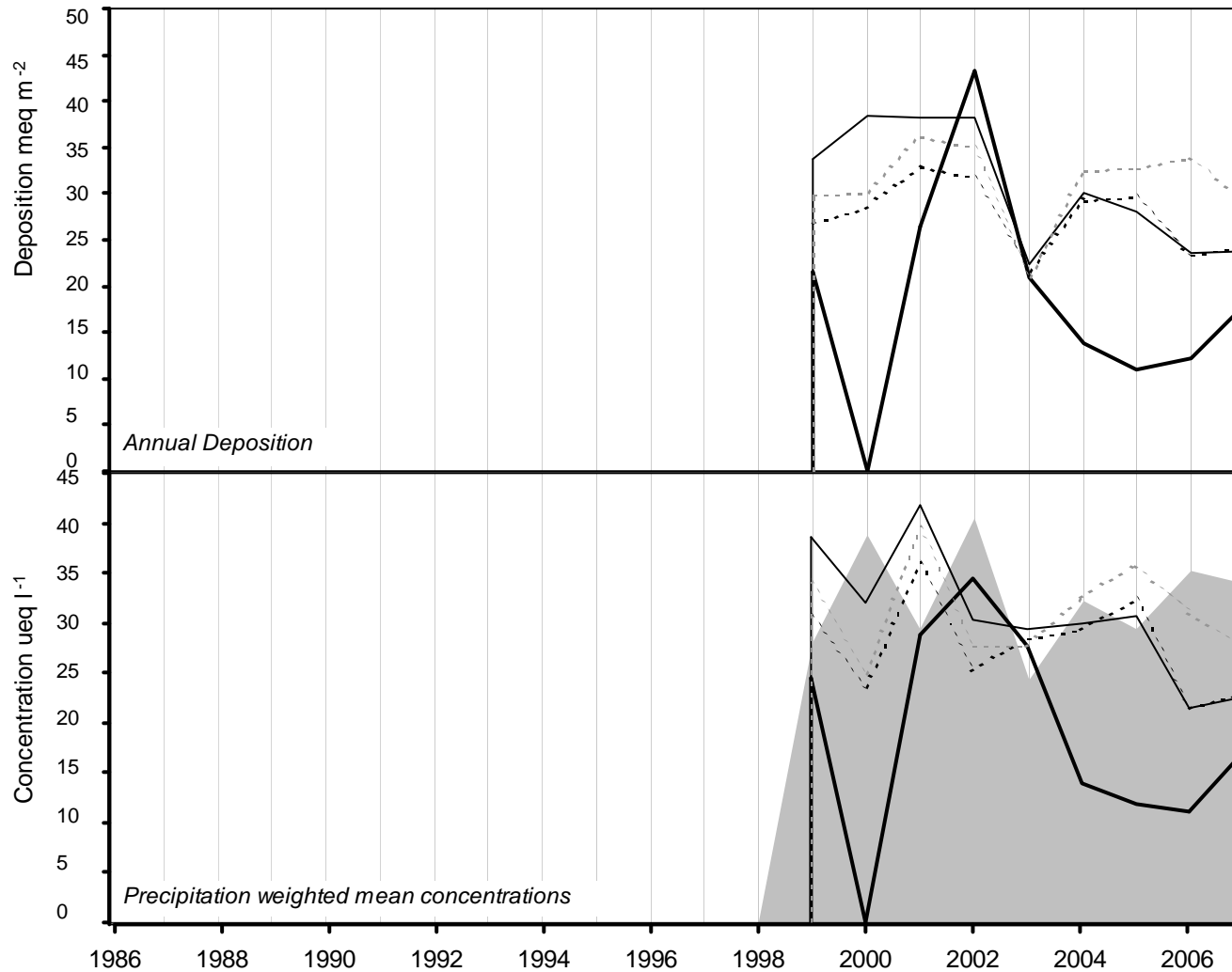

long-term trends in concentration (+x = increase; -x = decrease)	
<i>hydrogen ion</i>	-3.13 ueq/l (-4.34 %/year): 8 years' data - No significant trend detected
<i>non-marine sulphate</i>	-1.96 ueq/l (-3.06 %/year): 9 years' data ++ Moderately strong trend detected
<i>nitrate</i>	-0.77 ueq/l (-1.90 %/year): 9 years' data - No significant trend detected
<i>ammonium</i>	0.04 ueq/l (0.14 %/year): 9 years' data - No significant trend detected

### (5158) River Etherow

Start Date	End Date	pH	SO4 (µeq/l)	NO3 (µeq/l)	NH4 (µeq/l)	Na (µeq/l)	Mg (µeq/l)	Ca (µeq/l)	Cl (µeq/l)	K (µeq/l)	PO4 (µeq/l)	Nss SO4 (µeq/l)	H+ (µeq/l)	Conductivity (S/cm)	Rainfall (mm)
08/Jan/2007	23/Jan/2007	5.5	23.2	5.0	16.4	134.4	24.5	6.7	138.0	2.1	<1.0	7.0	3.3	21.0	92.0
23/Jan/2007	05/Feb/2007	-	-	-	-	-	-	-	-	-	-	-	-	-	0.0
05/Feb/2007	19/Feb/2007	4.5	26.0	25.8	23.3	50.6	11.7	10.4	53.9	1.3	<1.0	19.9	33.9	23.0	45.0
19/Feb/2007	05/Mar/2007	5.0	24.3	16.4	24.7	81.7	15.1	8.4	88.0	1.8	<1.0	14.5	9.8	18.4	77.0
05/Mar/2007	19/Mar/2007	5.8	38.4	20.9	34.7	119.0	20.7	11.7	134.9	3.1	<1.0	24.0	1.6	26.2	18.6
19/Mar/2007	02/Apr/2007	4.4	119.7	172.3	220.4	91.7	25.5	47.4	81.7	7.3	<1.0	108.7	39.8	65.1	11.6
02/Apr/2007	16/Apr/2007	-	-	-	-	-	-	-	-	-	-	-	-	-	0.0
16/Apr/2007	28/Apr/2007	4.7	68.1	93.4	76.4	55.3	17.5	68.7	40.1	3.4	<1.0	61.4	20.0	-	8.1
28/Apr/2007	15/May/2007	4.8	31.9	14.6	30.0	36.6	7.2	9.2	30.6	1.3	<1.0	27.4	14.8	14.4	96.6
15/May/2007	29/May/2007	4.6	51.9	38.9	39.7	99.8	21.8	22.0	105.4	3.0	<1.0	39.9	28.2	30.9	25.6
29/May/2007	11/Jun/2007	5.8	81.9	88.1	112.6	38.3	11.0	56.2	31.6	5.0	<1.0	77.3	1.4	30.4	9.6
11/Jun/2007	27/Jun/2007	4.6	25.4	21.3	20.6	5.5	1.6	4.3	6.4	0.5	<1.0	24.7	28.2	13.8	183.4
27/Jun/2007	12/Jul/2007	6.2	21.0	9.8	25.0	41.7	4.1	22.5	40.7	5.7	1.5	16.0	0.6	14.4	33.3
12/Jul/2007	26/Jul/2007	4.9	26.1	16.6	16.8	24.1	4.0	8.2	21.0	2.6	<1.0	23.2	13.8	12.1	84.3
26/Jul/2007	08/Aug/2007	-	-	-	-	-	-	-	-	-	-	-	-	-	0.0
08/Aug/2007	20/Aug/2007	4.8	23.1	18.3	24.5	27.7	6.5	12.4	28.7	2.0	<1.0	19.8	14.8	9.1	38.7
20/Aug/2007	06/Sep/2007	5.1	50.7	36.4	35.6	71.7	14.6	29.8	63.0	3.2	<1.0	42.1	8.3	19.3	11.3
06/Sep/2007	16/Sep/2007	-	-	-	-	-	-	-	-	-	-	-	-	-	1.4
16/Sep/2007	01/Oct/2007	5.4	24.3	10.7	22.3	55.6	12.5	9.1	66.0	2.1	<1.0	17.6	4.0	11.3	80.7
01/Oct/2007	14/Oct/2007	4.2	50.4	92.6	48.0	39.0	13.8	22.1	38.1	2.9	<1.0	45.7	58.9	40.7	19.2
14/Oct/2007	29/Oct/2007	-	-	-	-	-	-	-	-	-	-	-	-	-	1.7
29/Oct/2007	12/Nov/2007	-	-	-	-	-	-	-	-	-	-	-	-	-	0.0
12/Nov/2007	26/Nov/2007	4.5	33.8	51.2	47.8	46.1	9.5	7.4	48.6	2.0	<1.0	28.3	35.5	24.2	45.7
26/Nov/2007	10/Dec/2007	4.8	24.2	8.4	9.3	97.9	19.5	8.5	110.5	2.4	<1.0	12.4	15.1	20.3	96.1
10/Dec/2007	27/Dec/2007	4.8	43.9	64.5	52.4	91.4	19.6	16.0	72.6	4.8	1.2	32.9	15.8	30.3	19.6
27/Dec/2007	11/Jan/2008	4.9	28.8	20.1	27.0	119.7	24.8	8.4	127.9	3.0	2.1	14.3	13.5	23.0	56.7
			Precipitation<weighted annual means for site(samples containing phosphate are excluded)												
5158			29.7	23.0	27.5	59.6	12.0	10.6	62.0	2.1	0.6	22.6	17.1		Total rainfall 1056.1

# Thorganby

2007

Site Code: 5117  
 Easting: 4676  
 Northing: 4428  
 Latitude: 53 52 36 N  
 Longitude: 00 58 19 W  
 Altitude (m): 8  
 Rainfall (mm): 565  
 [30 year mean 1940 - 1971]

Site Environment:  
 Open meadow and arable land

Other measurements:  
 ---

Site Operator:  
 Selby District Council

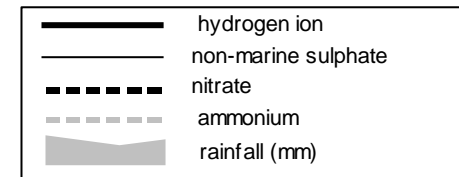
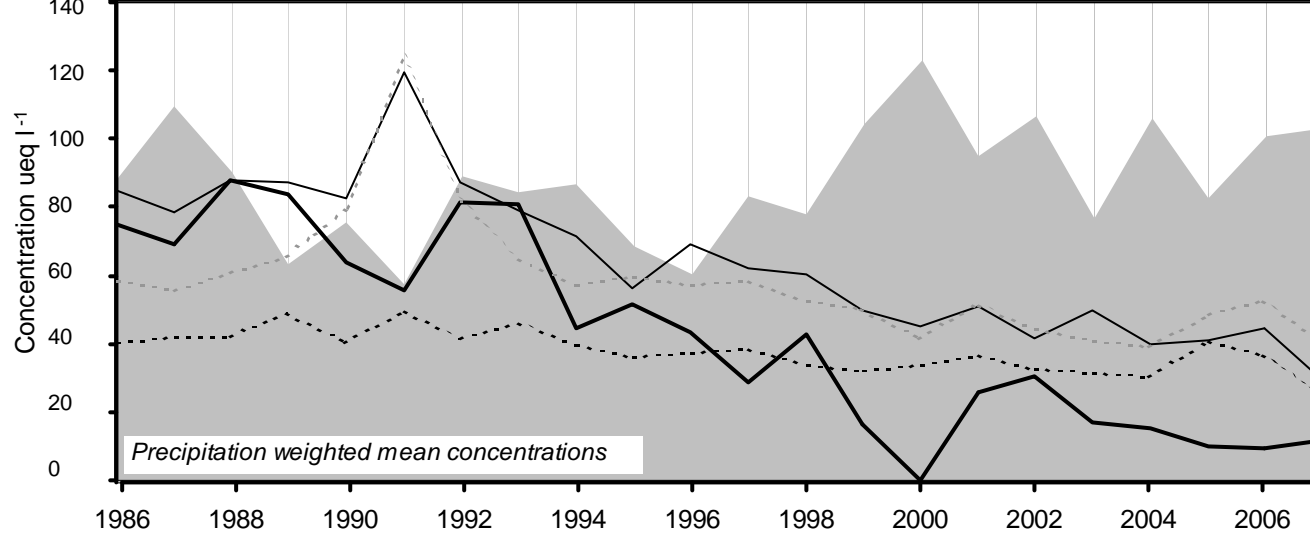
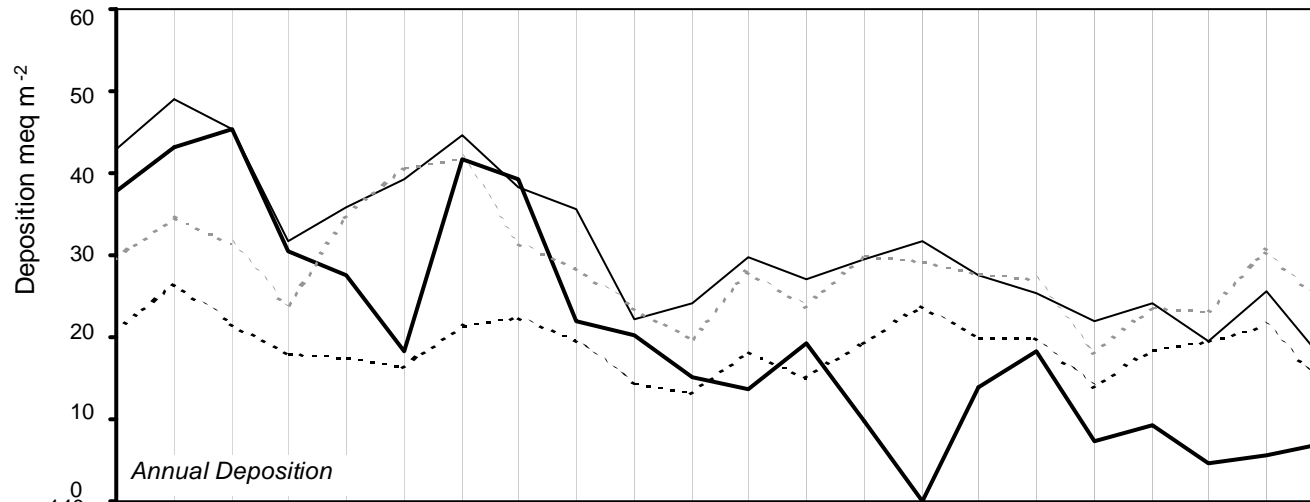

long-term trends in concentration (+x = increase; -x = decrease)	
<i>hydrogen ion</i>	-4.13 ueq/l (-4.78 %/year): 21 years' data ++++ Very strong trend detected
<i>non-marine sulphate</i>	-2.99 ueq/l (-3.12 %/year): 22 years' data ++++ Very strong trend detected
<i>nitrate</i>	-0.54 ueq/l (-1.21 %/year): 22 years' data ++ Moderately strong trend detected
<i>ammonium</i>	-1.56 ueq/l (-2.09 %/year): 21 years' data + Significant trend detected

Rainfall (mm)



### (5117) Thorganby

Start Date	End Date	pH	SO4 (µeq/l)	NO3 (µeq/l)	NH4 (µeq/l)	Na (µeq/l)	Mg (µeq/l)	Ca (µeq/l)	Cl (µeq/l)	K (µeq/l)	PO4 (µeq/l)	Nss SO4 (µeq/l)	H+ (µeq/l)	Conductivity (S/cm)	Rainfall (mm)	
03/Jan/2007	10/Jan/2007	5.1	45.0	12.7	46.4	51.0	12.6	11.5	58.4	3.0	<1.0	38.9	8.9	18.7	9.6	
10/Jan/2007	24/Jan/2007	5.4	43.9	9.3	19.8	253.3	53.7	19.5	271.0	4.6	<1.0	13.4	4.5	40.5	30.9	
24/Jan/2007	07/Feb/2007	-	-	-	-	-	-	-	-	-	-	-	-	-	0.0	
07/Feb/2007	21/Feb/2007	4.6	10.0	11.7	47.3	46.2	10.3	12.3	16.1	3.3	<1.0	4.5	26.9	22.2	22.5	
21/Feb/2007	07/Mar/2007	5.1	39.9	22.9	41.3	51.9	11.0	11.3	56.1	4.3	<1.0	33.6	8.1	19.1	29.0	
07/Mar/2007	14/Mar/2007	-	-	-	-	-	-	-	-	-	-	-	-	-	0.0	
14/Mar/2007	04/Apr/2007	7.7	478.6	100.2	1937.8	526.7	16.6	5.9	568.0	514.5	1129.2	415.2	0.0	377.0	9.4	
04/Apr/2007	25/Apr/2007	8.8	1092.4	40.0	10257.3	185.3	74.8	213.0	166.0	1375.0	2239.9	1070.1	0.0	1513.0	3.1	
25/Apr/2007	02/May/2007	-	-	-	-	-	-	-	-	-	-	-	-	-	0.0	
02/May/2007	16/May/2007	6.6	67.1	15.6	294.6	67.5	17.6	34.8	67.3	28.5	101.4	59.0	0.3	48.9	27.6	
16/May/2007	30/May/2007	7.7	193.7	41.6	1850.0	134.1	<0.8	<1.0	175.7	169.0	354.0	177.5	0.0	0.3	13.6	
30/May/2007	13/Jun/2007	4.7	85.6	89.9	117.8	54.1	22.4	69.8	52.0	35.3	3.7	79.0	20.0	-	2.5	
13/Jun/2007	27/Jun/2007	6.9	86.6	14.0	1186.2	45.7	5.9	6.6	36.9	81.0	194.0	81.1	0.1	131.3	166.4	
27/Jun/2007	11/Jul/2007	7.5	166.2	24.2	479.1	213.7	264.9	478.3	146.3	76.9	130.5	140.4	0.0	195.3	100.3	
11/Jul/2007	24/Jul/2007	6.6	110.5	25.2	366.9	93.7	8.8	9.0	68.4	74.5	213.9	99.2	0.3	69.2	43.9	
24/Jul/2007	02/Aug/2007	5.9	32.6	9.2	31.8	15.0	2.9	9.4	15.2	2.8	<1.0	30.8	1.1	8.0	5.8	
02/Aug/2007	15/Aug/2007	6.0	40.5	24.5	47.2	16.6	18.5	98.8	15.5	7.0	<1.0	38.5	1.0	23.2	15.3	
15/Aug/2007	29/Aug/2007	4.7	39.8	26.7	30.3	25.7	11.0	50.5	19.4	4.6	<1.0	36.7	20.0	-	8.3	
29/Aug/2007	12/Sep/2007	-	-	-	-	-	-	-	-	-	-	-	-	-	0.1	
12/Sep/2007	26/Sep/2007	6.2	48.2	15.6	45.6	53.6	17.4	48.5	56.5	4.8	1.3	41.7	0.6	19.0	23.9	
26/Sep/2007	10/Oct/2007	4.5	53.6	64.6	58.7	83.9	22.8	25.5	102.4	5.5	3.1	43.5	28.8	37.4	17.5	
10/Oct/2007	25/Oct/2007	-	-	-	-	-	-	-	-	-	-	-	-	-	0.5	
25/Oct/2007	15/Nov/2007	5.0	62.7	27.3	57.5	138.1	32.3	52.7	143.9	15.6	3.2	46.1	10.0	-	4.3	
15/Nov/2007	28/Nov/2007	4.7	33.4	45.1	40.1	61.1	16.4	14.8	63.8	2.4	<1.0	26.0	21.9	21.3	17.7	
28/Nov/2007	12/Dec/2007	5.2	31.2	13.2	24.4	86.6	16.7	12.1	95.0	3.1	<1.0	20.7	6.9	16.3	27.7	
12/Dec/2007	09/Jan/2008	4.6	48.5	38.5	56.2	67.0	16.1	11.7	72.3	3.2	2.1	40.4	22.9	27.0	10.6	
			Precipitation<weighted annual means for site(samples containing phosphate are excluded)													Total rainfall
5117			39.2	24.0	40.4	84.6	20.6	26.7	87.9	4.7	0.9	29.1	11.9	590.5		

# High Muffles

2007

Site Code: 5009  
 Easting: 4776  
 Northing: 4939  
 Latitude: 54 20 05 N  
 Longitude: 00 48 23 W  
 Altitude (m): 267  
 Rainfall (mm): 897  
 [30 year mean 1940 - 1971]

Site Environment:  
**Forestry plantation**

Other measurements:  
 DT, Daily SO<sub>4</sub>, HNO<sub>3</sub> Denuder, ozone, TOMPs, EMEP

Site Operator:  
**Forest Research**

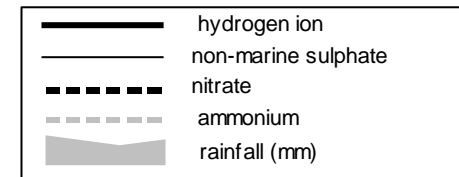
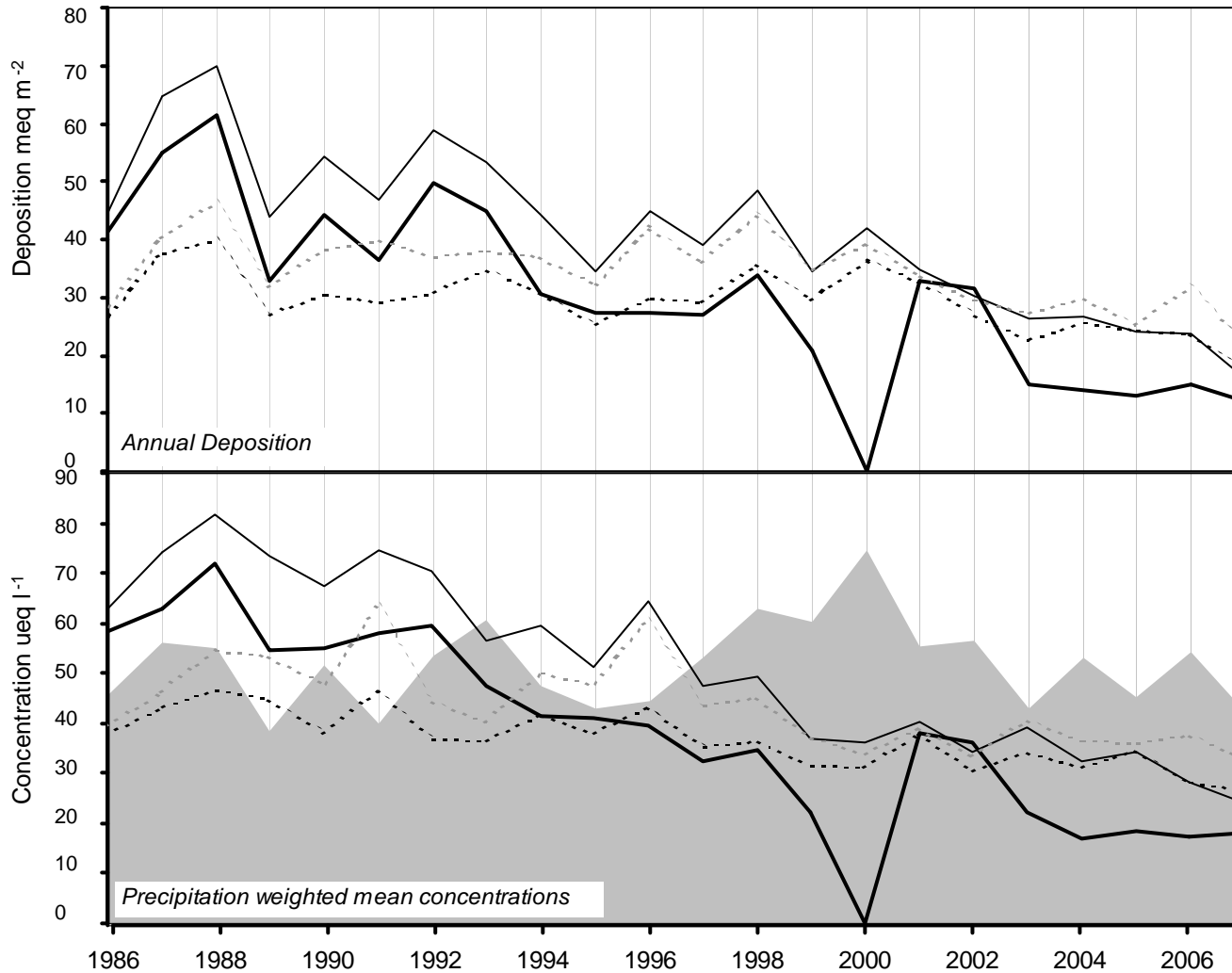

long-term trends in concentration (+x = increase; -x = decrease)	
<i>hydrogen ion</i>	-2.59 ueq/l (-3.91 %/year): 21 years' data +++ Very strong trend detected
<i>non-marine sulphate</i>	-2.52 ueq/l (-3.22 %/year): 22 years' data +++ Very strong trend detected
<i>nitrate</i>	-0.68 ueq/l (-1.54 %/year): 22 years' data +++ Strong trend detected
<i>ammonium</i>	-0.78 ueq/l (-1.49 %/year): 22 years' data ++ Moderately strong trend detected

### (5009) High Muffles

Start Date	End Date	pH	SO4 (µeq/l)	NO3 (µeq/l)	NH4 (µeq/l)	Na (µeq/l)	Mg (µeq/l)	Ca (µeq/l)	Cl (µeq/l)	K (µeq/l)	PO4 (µeq/l)	Nss SO4 (µeq/l)	H+ (µeq/l)	Conductivity (S/cm)	Rainfall (mm)	
03/Jan/2007	10/Jan/2007	5.0	33.7	17.5	33.7	44.2	9.0	7.1	47.3	1.6	2.4	28.3	10.7	17.0	15.6	
10/Jan/2007	24/Jan/2007	5.2	37.1	11.4	19.4	220.2	45.6	14.2	233.5	3.0	<1.0	10.6	6.0	35.1	13.8	
24/Jan/2007	14/Feb/2007	4.4	43.0	37.2	36.3	119.1	25.4	9.4	137.4	3.6	<1.0	28.6	43.7	36.5	49.0	
14/Feb/2007	28/Feb/2007	4.4	38.7	47.2	51.5	31.5	7.2	8.3	34.7	1.7	<1.0	34.9	38.0	24.3	52.1	
28/Feb/2007	07/Mar/2007	5.2	29.5	20.5	34.3	49.5	9.1	9.2	49.1	1.7	<1.0	23.5	6.0	15.1	13.0	
07/Mar/2007	21/Mar/2007	5.9	68.9	12.6	15.5	443.6	80.0	28.5	520.2	11.1	<1.0	15.4	1.2	77.7	17.0	
21/Mar/2007	04/Apr/2007	6.1	74.5	65.1	53.6	294.0	57.8	60.2	321.6	19.7	<1.0	39.1	0.8	56.9	2.9	
04/Apr/2007	18/Apr/2007	-	-	-	-	-	-	-	-	-	-	-	-	-	0.0	
18/Apr/2007	02/May/2007	6.3	114.1	68.1	190.3	54.9	12.8	27.1	63.5	8.8	2.4	107.5	0.5	41.3	6.3	
02/May/2007	16/May/2007	6.4	32.4	8.6	109.1	57.2	8.0	12.9	60.4	14.6	19.0	25.5	0.4	27.6	41.5	
16/May/2007	06/Jun/2007	5.3	54.8	30.9	34.8	185.7	40.3	41.8	198.7	8.8	<1.0	32.4	4.8	39.2	23.9	
06/Jun/2007	13/Jun/2007	4.4	85.9	77.2	101.8	16.8	5.5	41.3	7.5	7.0	<1.0	83.9	39.8	-	3.2	
13/Jun/2007	27/Jun/2007	-	-	-	-	-	-	-	-	-	-	-	-	-	0.0	
27/Jun/2007	11/Jul/2007	4.9	17.1	11.3	13.1	5.5	2.7	5.1	7.7	2.0	<1.0	16.4	12.9	7.1	73.2	
11/Jul/2007	25/Jul/2007	4.5	24.0	22.3	17.9	12.2	3.9	8.1	14.7	2.6	<1.0	22.6	35.5	14.7	53.4	
25/Jul/2007	08/Aug/2007	5.2	41.9	14.3	14.0	47.0	8.4	30.1	33.3	6.5	<1.0	36.2	6.5	9.0	1.6	
08/Aug/2007	22/Aug/2007	5.1	28.8	20.3	37.8	25.5	6.4	11.8	28.2	3.2	<1.0	25.8	8.3	9.0	52.5	
22/Aug/2007	06/Sep/2007	-	-	-	-	-	-	-	-	-	-	-	-	-	0.0	
06/Sep/2007	19/Sep/2007	5.8	42.6	7.3	12.7	232.3	53.6	29.0	254.3	7.1	<1.0	14.7	1.6	35.3	13.6	
19/Sep/2007	03/Oct/2007	5.4	32.2	9.4	20.8	198.4	42.2	21.0	211.0	5.4	<1.0	8.3	4.2	36.3	49.0	
03/Oct/2007	31/Oct/2007	4.7	72.4	85.1	93.1	28.9	11.0	44.8	26.2	4.3	3.4	69.0	22.4	27.7	14.2	
31/Oct/2007	14/Nov/2007	5.6	42.5	13.3	25.0	229.0	49.5	24.9	238.5	7.4	3.0	14.9	2.3	33.0	18.7	
14/Nov/2007	28/Nov/2007	4.6	46.1	43.5	41.7	197.9	41.1	19.7	216.1	4.9	3.2	22.3	26.9	41.2	62.7	
28/Nov/2007	12/Dec/2007	5.6	23.0	10.8	17.3	109.0	15.9	7.0	100.2	2.2	8.0	9.9	2.6	15.6	39.6	
12/Dec/2007	03/Jan/2008	4.7	34.3	34.3	44.3	50.9	10.8	9.1	52.3	3.3	1.2	28.2	19.5	21.5	42.9	
			Precipitation<weighted annual means for site(samples containing phosphate are excluded)													Total rainfall
5009			36.6	26.8	33.3	103.6	21.7	14.9	112.2	4.0	1.5	24.1	18.1	659.7		

# Bannisdale

2007

Site Code: 5111  
 Easting: 3515  
 Northing: 5043  
 Latitude: 54 25 54 N  
 Longitude: 02 44 52 W  
 Altitude (m): 265  
 Rainfall (mm): 2035  
 [30 year mean 1940 - 1971]

Site Environment:  
 Open moorland, sheep grazing

Other measurements:  
 DT, HNO3 Denuder

Site Operator:  
 Mr. R Newport

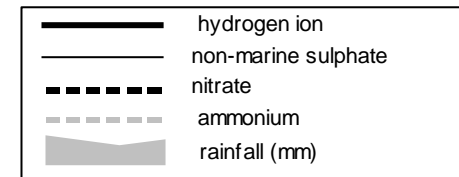
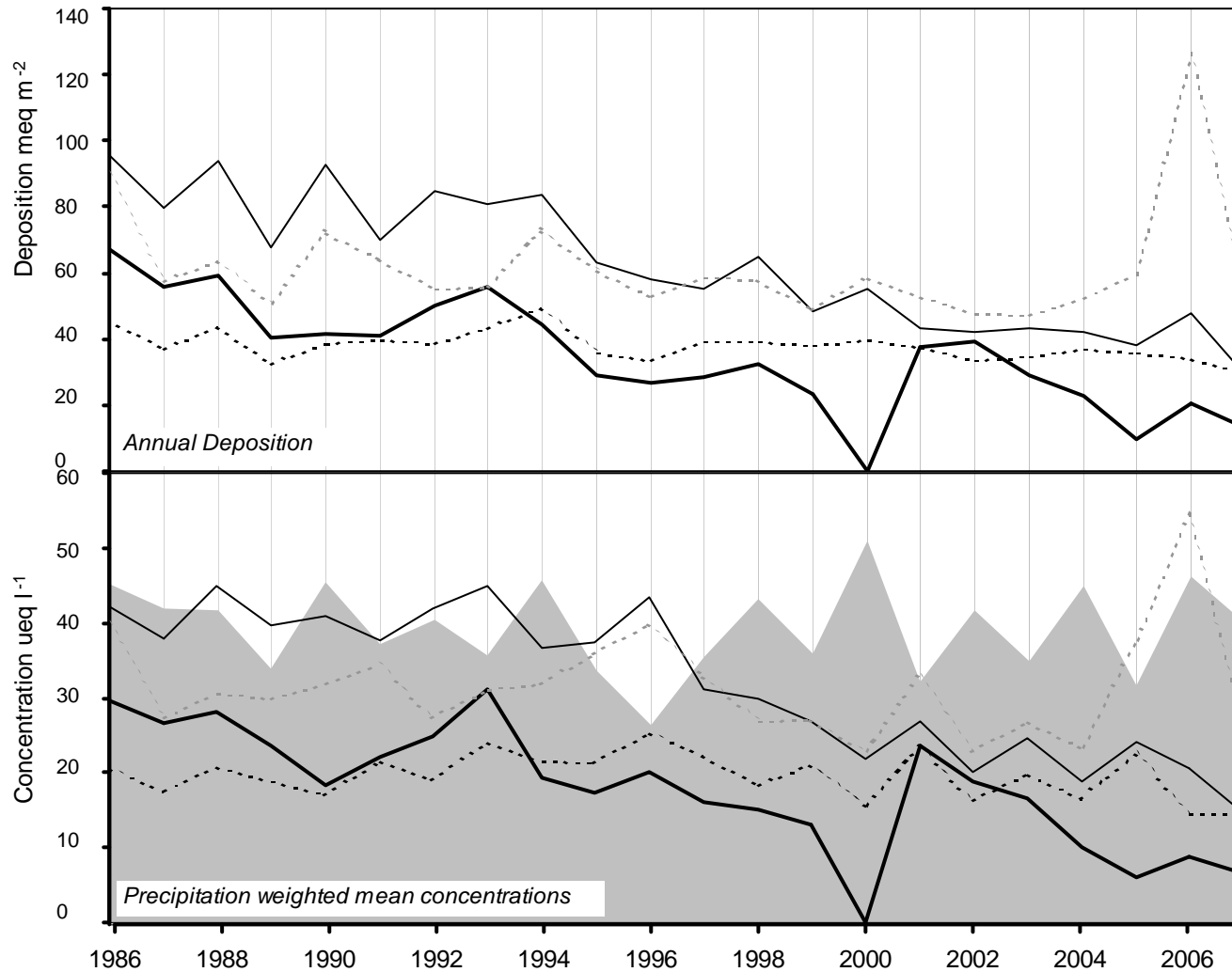

long-term trends in concentration (+x = increase; -x = decrease)	
<i>hydrogen ion</i>	-0.97 ueq/l (-3.38 %/year): 21 years' data +++ Strong trend detected
<i>non-marine sulphate</i>	-1.33 ueq/l (-2.89 %/year): 22 years' data ++++ Very strong trend detected
<i>nitrate</i>	-0.14 ueq/l (-0.65 %/year): 22 years' data - No significant trend detected
<i>ammonium</i>	0.40 ueq/l (1.40 %/year): 22 years' data - No significant trend detected

(5111) Bannisdale

Start Date	End Date	pH	SO4 (µeq/l)	NO3 (µeq/l)	NH4 (µeq/l)	Na (µeq/l)	Mg (µeq/l)	Ca (µeq/l)	Cl (µeq/l)	K (µeq/l)	PO4 (µeq/l)	Nss SO4 (µeq/l)	H+ (µeq/l)	Conductivity (S/cm)	Rainfall (mm)	
10/Jan/2007	24/Jan/2007	5.6	63.8	7.9	15.8	607.3	116.8	26.1	605.9	7.6	<1.0	0.0	2.5	74.9	169.2	
24/Jan/2007	07/Feb/2007	4.7	98.9	49.0	207.7	358.2	59.7	23.8	378.9	14.9	<1.0	55.8	20.0	-	3.4	
07/Feb/2007	21/Feb/2007	4.9	32.3	34.3	58.2	70.7	13.7	7.2	77.7	1.9	<1.0	23.8	11.5	22.1	64.3	
21/Feb/2007	07/Mar/2007	5.6	26.7	14.7	27.1	119.8	19.0	8.2	120.8	2.8	<1.0	12.3	2.5	21.0	139.7	
07/Mar/2007	21/Mar/2007	5.9	41.3	12.0	33.2	232.3	43.3	11.9	255.3	4.9	<1.0	13.3	1.3	39.8	79.2	
21/Mar/2007	04/Apr/2007	4.8	41.7	84.4	103.4	24.2	7.4	15.2	25.5	4.5	<1.0	38.8	15.5	23.7	15.7	
04/Apr/2007	17/Apr/2007	-	-	-	-	-	-	-	-	-	-	-	-	-	0.0	
17/Apr/2007	01/May/2007	5.4	30.1	20.5	42.3	8.1	2.8	11.5	10.0	1.1	<1.0	29.2	4.0	10.5	118.6	
01/May/2007	16/May/2007	5.5	31.9	20.6	39.1	116.0	22.9	16.2	115.7	3.7	<1.0	17.9	3.1	23.0	73.6	
16/May/2007	30/May/2007	5.6	42.0	16.7	32.8	206.9	38.4	18.8	221.4	5.8	<1.0	17.1	2.7	37.3	29.3	
30/May/2007	13/Jun/2007	5.1	65.0	82.3	108.0	17.0	5.1	39.4	18.5	4.4	<1.0	62.9	8.7	26.5	23.0	
13/Jun/2007	27/Jun/2007	4.7	16.7	17.1	16.6	13.5	2.5	4.0	14.8	1.8	<1.0	15.1	19.1	10.7	121.3	
27/Jun/2007	11/Jul/2007	5.0	13.0	7.2	9.0	22.3	4.1	2.6	27.2	1.4	<1.0	10.4	9.8	8.0	155.0	
11/Jul/2007	25/Jul/2007	5.5	25.9	21.6	30.8	21.6	3.7	3.6	18.9	4.3	<1.0	23.2	3.5	10.1	75.5	
25/Jul/2007	08/Aug/2007	5.1	20.5	8.6	18.0	54.8	9.5	7.2	55.8	2.1	<1.0	13.9	8.5	9.4	84.9	
08/Aug/2007	22/Aug/2007	-	-	-	-	-	-	-	-	-	-	-	-	-	0.0	
22/Aug/2007	05/Sep/2007	5.0	23.7	16.3	34.5	90.6	5.1	7.5	46.0	6.0	<1.0	12.8	10.0	-	7.4	
05/Sep/2007	19/Sep/2007	5.5	26.1	12.6	23.3	103.7	21.6	15.1	122.1	3.1	<1.0	13.7	3.5	18.6	50.7	
19/Sep/2007	03/Oct/2007	5.5	19.2	9.5	20.2	57.2	12.4	8.2	67.0	1.9	<1.0	12.3	3.5	10.0	90.0	
03/Oct/2007	17/Oct/2007	6.7	56.2	48.3	198.0	33.9	12.1	19.7	56.4	9.3	49.9	52.1	0.2	33.3	58.9	
17/Oct/2007	31/Oct/2007	5.6	22.3	15.5	36.5	71.6	11.8	7.5	73.3	2.2	2.8	13.6	2.5	11.7	52.0	
31/Oct/2007	14/Nov/2007	5.6	40.7	21.1	39.2	173.4	32.8	14.1	189.5	4.9	2.8	19.8	2.5	30.3	26.0	
14/Nov/2007	28/Nov/2007	5.8	39.4	36.7	73.4	74.0	10.4	8.2	78.8	7.2	12.3	30.5	1.7	20.0	96.2	
28/Nov/2007	12/Dec/2007	5.3	26.6	6.1	11.1	186.1	37.4	10.6	193.9	3.7	1.3	4.1	5.2	26.2	181.2	
12/Dec/2007	26/Dec/2007	6.0	54.5	42.3	106.7	126.5	20.8	9.1	131.0	14.8	14.6	39.3	1.0	34.6	17.3	
26/Dec/2007	12/Jan/2008	5.0	27.4	10.4	15.8	162.4	32.5	9.9	174.7	4.1	<1.0	7.8	9.1	26.9	272.3	
5111		Precipitation<weighted annual means for site(samples containing phosphate are excluded)														Total rainfall
5111			30.0	14.6	25.3	146.6	28.2	10.9	152.3	3.5	0.7	14.5	6.5		2004.5	

# Scoat Tarn

2007

Site Code: 5159  
 Easting: 3158  
 Northing: 5103  
 Latitude: 54 48 10 N  
 Longitude: 03 30 10 W  
 Altitude (m): 595  
 Rainfall (mm): 3597  
 [30 year mean 1940 - 1971]

Site Environment:  
**Grassland**

Other measurements:  
**UKAWMN. Lakewater and soil chemistry**

Site Operator:  
**ENSIS**

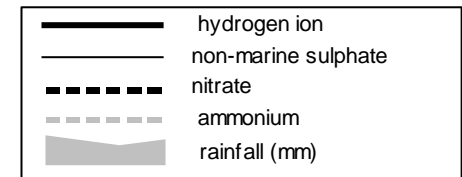
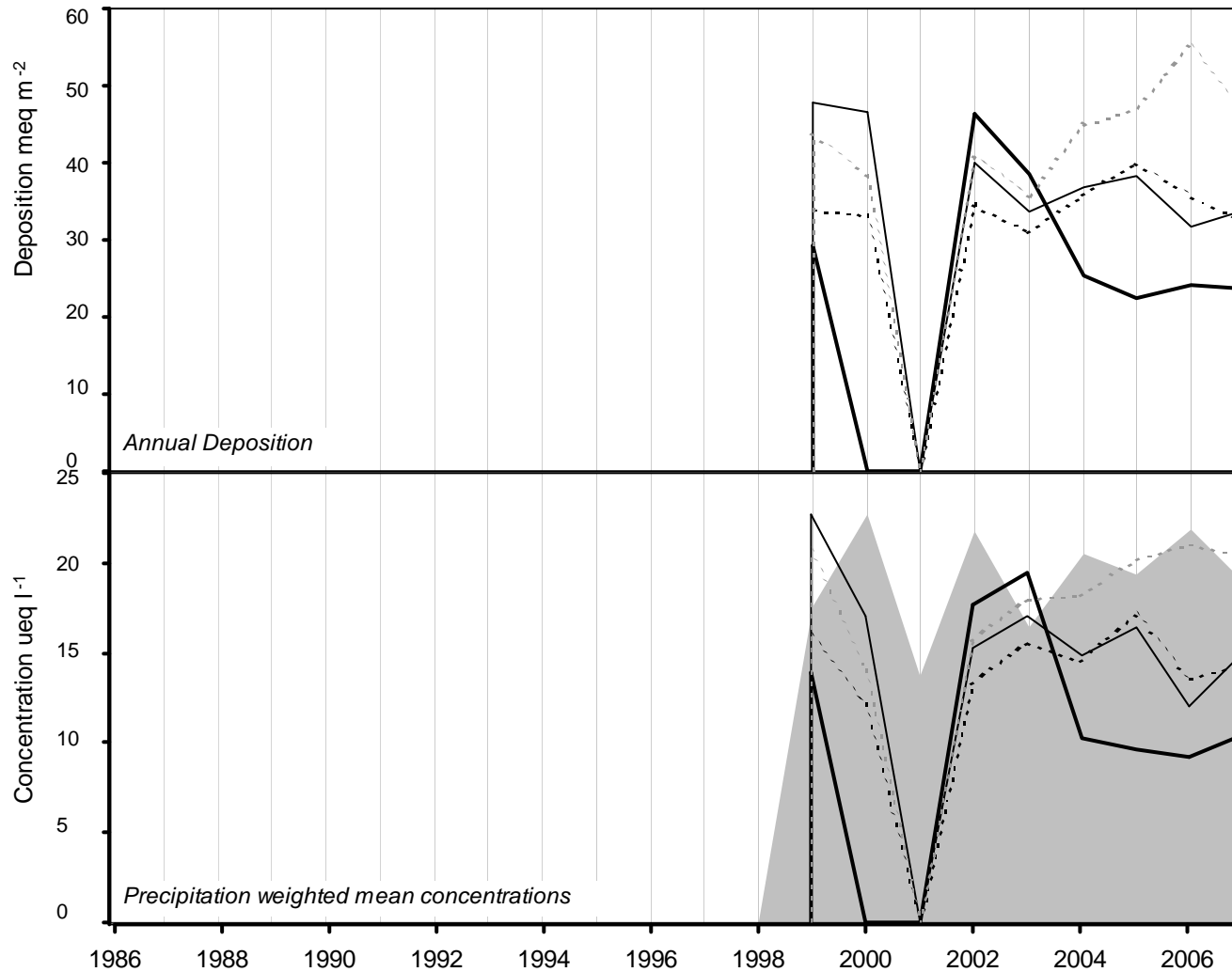

long-term trends in concentration (+x = increase; -x = decrease)	
<i>hydrogen ion</i>	-1.36 ueq/l (-3.79 %/year): 8 years' data - No significant trend detected
<i>non-marine sulphate</i>	-0.84 ueq/l (-2.72 %/year): 9 years' data + Significant trend detected
<i>nitrate</i>	0.02 ueq/l (0.15 %/year): 9 years' data - No significant trend detected
<i>ammonium</i>	0.53 ueq/l (5.65 %/year): 9 years' data - No significant trend detected

### (5159) Scoat Tarn

Start Date	End Date	pH	SO4 (µeq/l)	NO3 (µeq/l)	NH4 (µeq/l)	Na (µeq/l)	Mg (µeq/l)	Ca (µeq/l)	Cl (µeq/l)	K (µeq/l)	PO4 (µeq/l)	Nss SO4 (µeq/l)	H+ (µeq/l)	Conductivity (S/cm)	Rainfall (mm)
09/Jan/2007	23/Jan/2007	5.4	17.5	2.4	9.2	323.7	65.1	14.6	152.8	4.2	<1.0	0.0	4.4	46.6	116.6
23/Jan/2007	06/Feb/2007	6.1	28.0	14.9	56.4	103.6	14.3	4.7	108.8	2.6	<1.0	15.5	0.9	22.1	26.8
06/Feb/2007	20/Feb/2007	4.8	29.3	28.3	37.4	80.2	13.8	6.0	89.1	4.1	<1.0	19.6	17.4	21.0	56.1
20/Feb/2007	06/Mar/2007	5.1	18.2	12.0	1.0	8.9	2.1	<1.0	82.5	0.5	3.2	17.1	8.5	17.0	174.4
06/Mar/2007	20/Mar/2007	5.4	41.1	15.2	28.3	178.3	35.2	10.5	191.8	3.8	<1.0	19.6	3.6	31.4	57.5
20/Mar/2007	03/Apr/2007	4.6	27.1	65.4	49.6	39.4	8.1	17.9	41.0	3.4	<1.0	22.4	26.9	23.9	11.9
03/Apr/2007	17/Apr/2007	-	-	-	-	-	-	-	-	-	-	-	-	-	0.0
17/Apr/2007	28/Apr/2007	4.9	21.6	12.8	25.0	11.4	4.0	24.3	9.8	1.4	<1.0	20.2	12.9	8.8	191.4
28/Apr/2007	14/May/2007	5.0	28.2	14.8	31.5	112.3	22.9	10.8	102.6	2.5	<1.0	14.7	9.3	22.5	75.8
14/May/2007	29/May/2007	5.5	19.5	13.4	25.9	59.7	10.5	6.7	62.8	3.0	<1.0	12.3	3.2	13.4	75.4
29/May/2007	11/Jun/2007	-	-	-	-	-	-	-	-	-	-	-	-	-	0.0
11/Jun/2007	28/Jun/2007	4.7	19.7	21.6	22.9	14.6	3.0	3.0	16.9	0.7	<1.0	17.9	18.2	11.8	145.9
28/Jun/2007	11/Jul/2007	5.1	21.2	9.3	11.4	60.7	9.5	3.2	79.0	4.2	<1.0	13.9	7.6	13.1	77.7
11/Jul/2007	27/Jul/2007	-	-	-	-	-	-	-	-	-	-	-	-	-	0.0
09/Aug/2007	21/Aug/2007	4.7	17.0	11.7	12.3	27.7	5.2	7.0	29.5	1.1	<1.0	13.6	20.9	7.6	140.4
21/Aug/2007	05/Sep/2007	5.8	18.6	12.0	35.0	47.0	4.7	3.2	49.4	2.7	<1.0	13.0	1.5	9.6	49.9
05/Sep/2007	15/Sep/2007	6.3	39.4	26.2	53.8	100.1	15.9	10.6	90.6	3.9	<1.0	27.3	0.5	18.9	13.0
15/Sep/2007	02/Oct/2007	5.5	19.4	6.4	15.4	100.6	19.0	7.9	105.2	2.4	1.4	7.3	3.5	14.9	250.9
02/Oct/2007	15/Oct/2007	4.8	32.4	30.9	34.5	28.2	8.6	10.7	31.0	1.2	<1.0	29.0	16.6	14.5	72.1
15/Oct/2007	30/Oct/2007	4.9	27.3	17.9	22.9	97.5	19.5	7.2	101.0	2.6	<1.0	15.5	13.8	19.5	98.0
30/Oct/2007	13/Nov/2007	5.7	31.0	14.7	36.7	128.6	23.7	10.3	136.9	5.0	3.2	15.5	1.9	20.9	63.1
13/Nov/2007	27/Nov/2007	4.6	36.4	30.1	26.2	143.7	30.7	10.3	152.8	3.2	2.8	19.1	26.3	32.1	63.9
27/Nov/2007	11/Dec/2007	5.2	3.4	<0.7	6.7	99.0	18.4	5.9	104.7	2.0	16.1	0.0	6.6	13.0	282.1
11/Dec/2007	23/Dec/2007	5.1	24.7	10.8	12.0	141.4	27.3	8.4	146.4	3.4	2.2	7.7	7.2	24.7	89.7
23/Dec/2007	08/Jan/2008	4.9	30.8	15.0	16.8	173.0	37.2	11.7	187.1	3.8	2.3	9.9	12.6	31.2	128.1
		Precipitation<weighted annual means for site(samples containing phosphate are excluded)													Total rainfall
5159			23.6	14.3	20.4	88.9	17.6	9.1	89.2	2.4	1.2	15.0	10.5		2260.6

# Hillsborough Forest

2007

Site Code: 5149  
 Easting: 1349  
 Northing: 5156  
 Latitude: 54 27 09 N  
 Longitude: 06 05 03 W  
 Altitude (m): 120  
 Rainfall (mm): 965  
 [30 year mean 1940 - 1971]

Site Environment:  
 Open arable, cows graze in summer

Other measurements:  
 DT

Site Operator:  
 Agri-Food and Biosciences Institute, NI

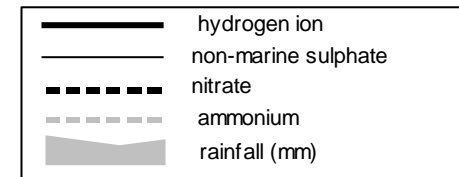
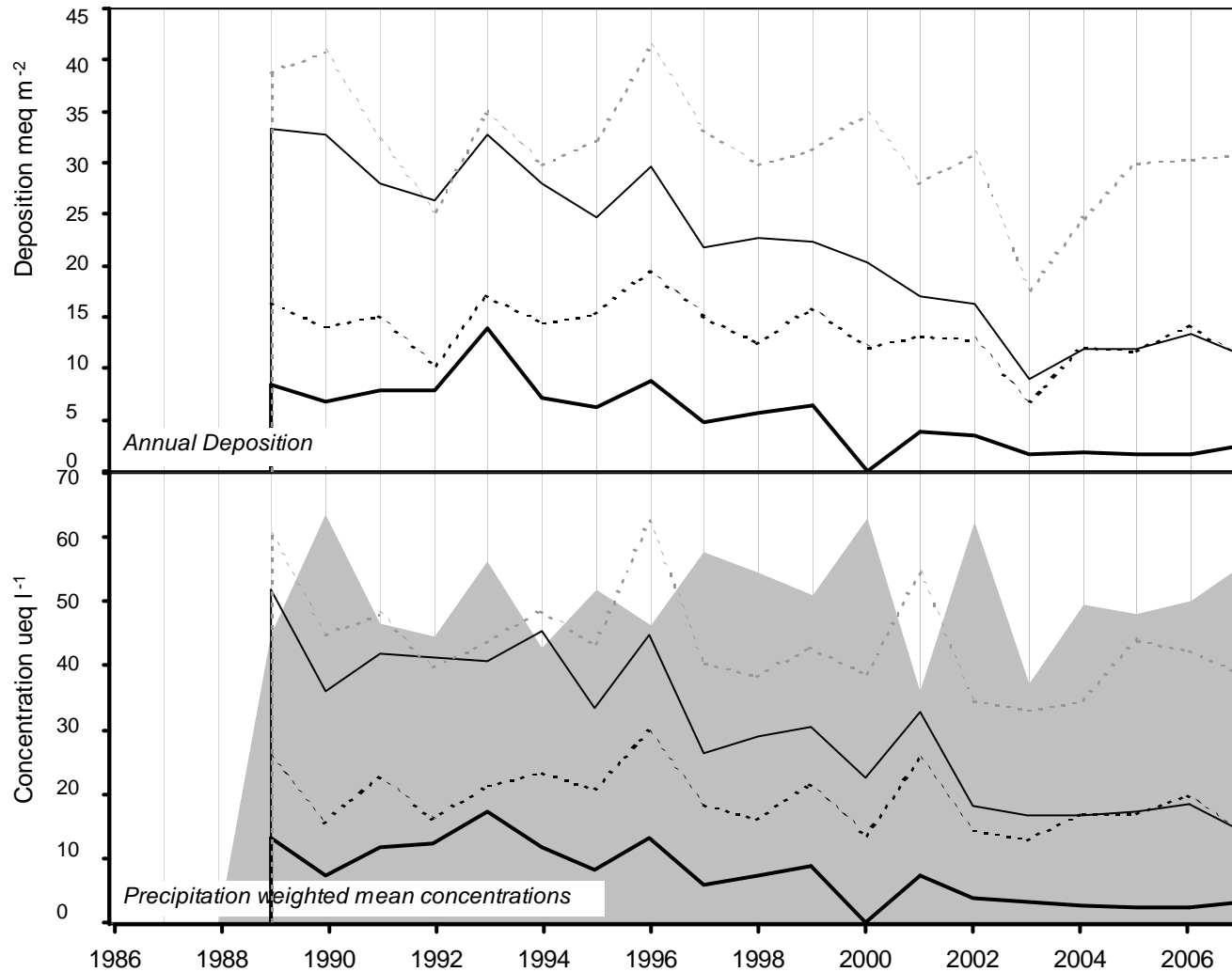

long-term trends in concentration (+x = increase; -x = decrease)	
<i>hydrogen ion</i>	-0.70 ueq/l (-4.41 %/year): 18 years' data +++ Strong trend detected
<i>non-marine sulphate</i>	-1.86 ueq/l (-3.54 %/year): 19 years' data ++++ Very strong trend detected
<i>nitrate</i>	-0.26 ueq/l (-1.15 %/year): 19 years' data - No significant trend detected
<i>ammonium</i>	-0.63 ueq/l (-1.22 %/year): 19 years' data - No significant trend detected



(5149) Hillsborough Forest

Start Date	End Date	pH	SO4 (µeq/l)	NO3 (µeq/l)	NH4 (µeq/l)	Na (µeq/l)	Mg (µeq/l)	Ca (µeq/l)	Cl (µeq/l)	K (µeq/l)	PO4 (µeq/l)	Nss SO4 (µeq/l)	H+ (µeq/l)	Conductivity (S/cm)	Rainfall (mm)
03/Jan/2007	12/Jan/2007	5.8	28.6	4.1	32.0	200.7	34.9	8.5	214.9	5.1	<1.0	4.4	1.6	33.2	27.5
12/Jan/2007	22/Jan/2007	5.5	29.8	5.2	31.0	201.4	33.9	7.5	214.5	2.7	2.1	5.5	3.1	34.6	22.8
22/Jan/2007	07/Feb/2007	4.4	94.4	28.5	76.1	132.9	16.6	9.7	277.5	3.3	<1.0	78.4	39.8	-	1.3
07/Feb/2007	23/Feb/2007	5.2	42.4	28.0	58.0	156.8	31.6	10.8	177.7	3.6	<1.0	23.5	5.8	32.7	44.1
23/Feb/2007	07/Mar/2007	5.7	21.1	6.6	23.8	111.7	16.5	7.3	120.8	3.3	<1.0	7.6	1.9	20.1	39.5
07/Mar/2007	21/Mar/2007	6.0	56.0	6.5	30.8	414.8	80.1	20.1	457.8	7.5	<1.0	6.0	1.0	63.9	24.9
21/Mar/2007	04/Apr/2007	6.5	112.5	78.9	124.8	157.2	36.6	100.6	143.9	18.6	<1.0	93.5	0.3	53.8	5.8
04/Apr/2007	18/Apr/2007	-	-	-	-	-	-	-	-	-	-	-	-	-	0.0
18/Apr/2007	02/May/2007	6.1	24.7	21.3	59.5	35.5	6.2	16.5	40.1	2.0	<1.0	20.5	0.7	17.3	9.6
02/May/2007	17/May/2007	6.2	14.8	9.9	34.4	36.4	5.6	5.4	39.1	2.7	<1.0	10.4	0.7	3.9	36.5
17/May/2007	30/May/2007	6.3	48.7	18.6	60.1	200.0	34.6	30.9	213.1	7.3	<1.0	24.6	0.5	43.1	7.0
30/May/2007	13/Jun/2007	5.2	18.2	19.0	33.8	6.6	1.3	5.2	7.5	1.0	<1.0	17.4	5.9	7.4	67.4
13/Jun/2007	27/Jun/2007	6.4	33.6	15.2	174.0	39.9	2.7	1.1	56.6	31.9	56.6	28.8	0.4	32.6	91.5
27/Jun/2007	11/Jul/2007	6.2	16.0	5.3	45.7	15.6	3.9	3.1	17.2	4.0	8.1	14.1	0.6	9.5	82.5
11/Jul/2007	25/Jul/2007	5.7	19.5	17.8	44.5	12.5	1.1	1.5	13.0	2.3	<1.0	18.0	1.8	8.8	47.9
25/Jul/2007	09/Aug/2007	5.5	10.1	4.3	15.6	18.1	2.6	6.6	18.6	1.2	<1.0	7.9	3.4	4.4	46.4
09/Aug/2007	22/Aug/2007	5.7	6.2	5.9	16.4	36.2	2.5	4.9	34.5	1.0	<1.0	1.9	2.2	6.0	72.1
22/Aug/2007	05/Sep/2007	-	-	-	-	-	-	-	-	-	-	-	-	-	0.0
05/Sep/2007	20/Sep/2007	6.5	26.0	12.9	48.2	87.3	17.9	19.7	99.9	6.2	1.5	15.5	0.4	18.1	9.7
20/Sep/2007	03/Oct/2007	6.0	45.6	20.9	71.4	186.9	36.2	25.9	203.0	5.2	<1.0	23.1	1.1	41.4	11.2
03/Oct/2007	17/Oct/2007	5.9	77.6	55.7	581.2	60.2	40.6	44.7	76.0	825.1	326.5	70.4	1.3	-	3.4
17/Oct/2007	31/Oct/2007	6.5	27.2	24.5	87.5	89.3	11.0	6.2	90.4	3.7	9.4	16.4	0.4	21.4	12.8
31/Oct/2007	14/Nov/2007	4.7	74.4	11.2	60.1	434.5	84.3	29.7	475.9	10.3	2.8	22.0	20.0	-	11.7
14/Nov/2007	28/Nov/2007	5.4	36.3	31.0	59.6	98.7	17.7	6.8	105.8	6.2	9.0	24.4	4.3	21.8	60.3
28/Nov/2007	12/Dec/2007	5.4	18.4	4.7	17.6	72.8	11.7	4.8	80.7	5.4	5.3	9.6	4.5	15.6	45.3
12/Dec/2007	01/Jan/2008	6.5	46.8	15.5	135.4	132.1	15.3	6.0	141.1	25.2	44.8	30.9	0.3	39.6	19.5
		Precipitation<weighted annual means for site(samples containing phosphate are excluded)													
5149			24.6	13.3	38.6	87.6	15.4	8.3	95.0	3.7	2.7	14.0	3.1		Total rainfall 800.7

# Lough Navar

2007

Site Code: 5006  
 Easting: 192  
 Northing: 5212  
 Latitude: 54 26 20 N  
 Longitude: 07 54 00 W  
 Altitude (m): 130  
 Rainfall (mm): 808  
 [30 year mean 1940 - 1971]

Site Environment:  
 Clearing near Forestry Offices

Other measurements:  
 DT, Daily SO<sub>4</sub>, HNO<sub>3</sub> Denuder, ozone, EMEP

Site Operator:  
 Forestry Service, NI

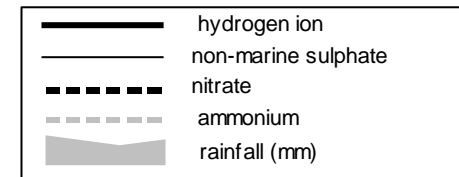
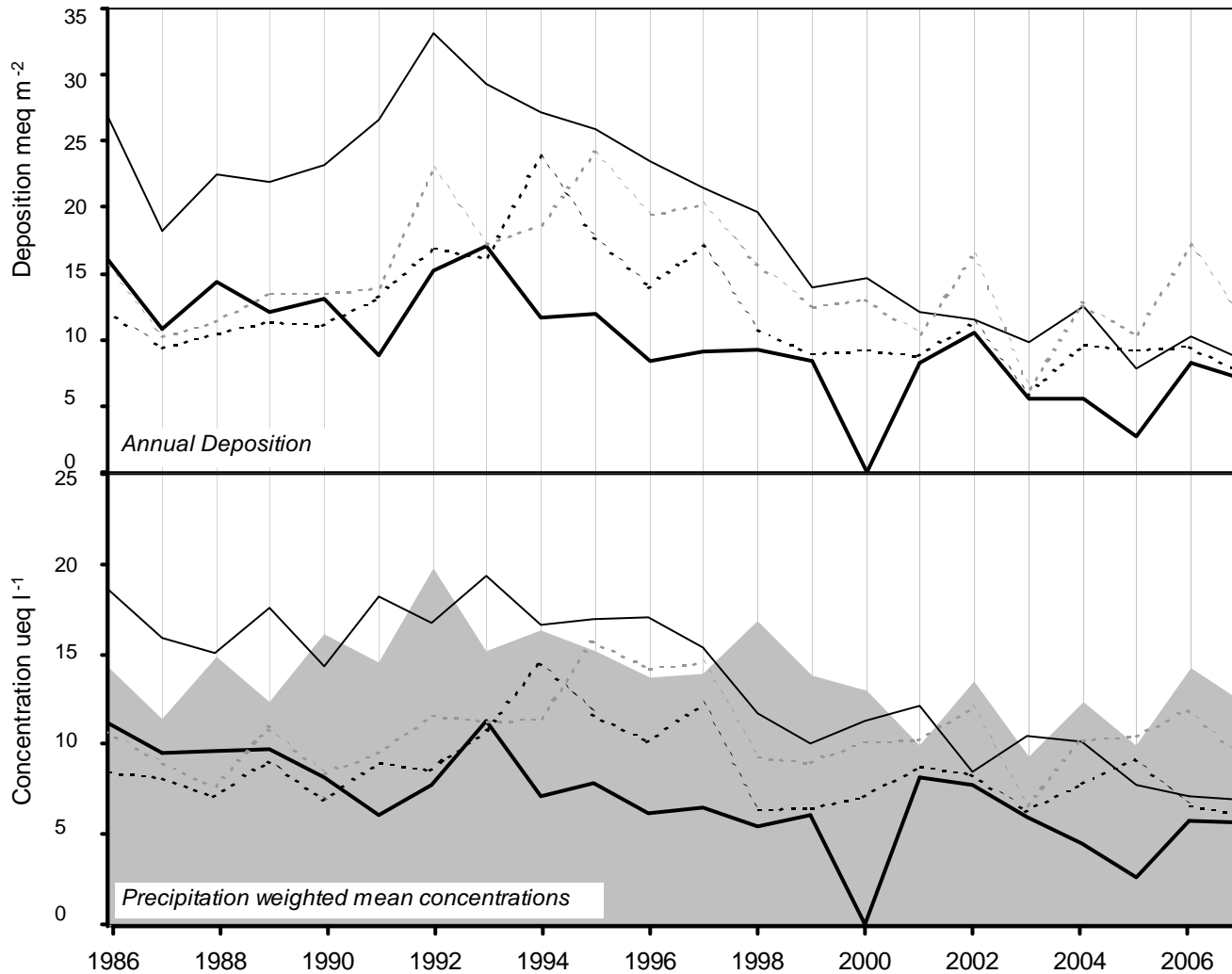

long-term trends in concentration (+x = increase; -x = decrease)	
<i>hydrogen ion</i>	-0.26 ueq/l (-2.65 %/year): 21 years' data +++ Strong trend detected
<i>non-marine sulphate</i>	-0.53 ueq/l (-2.80 %/year): 22 years' data ++++ Very strong trend detected
<i>nitrate</i>	-0.07 ueq/l (-0.79 %/year): 22 years' data - No significant trend detected
<i>ammonium</i>	0.04 ueq/l (0.37 %/year): 22 years' data - No significant trend detected

(5006) Lough Navar

Start Date	End Date	pH	SO4 (µeq/l)	NO3 (µeq/l)	NH4 (µeq/l)	Na (µeq/l)	Mg (µeq/l)	Ca (µeq/l)	Cl (µeq/l)	K (µeq/l)	PO4 (µeq/l)	Nss SO4 (µeq/l)	H+ (µeq/l)	Conductivity (S/cm)	Rainfall (mm)
08/Jan/2007	22/Jan/2007	5.4	34.0	2.2	<0.7	323.1	64.8	17.6	335.0	5.6	<1.0	0.0	4.0	45.9	124.1
22/Jan/2007	05/Feb/2007	5.5	36.5	3.1	21.4	274.8	57.6	33.1	293.2	22.6	<1.0	3.4	3.5	40.0	9.9
05/Feb/2007	19/Feb/2007	5.5	20.0	15.2	28.5	83.1	14.1	8.3	89.6	2.3	<1.0	10.0	3.4	17.5	36.6
19/Feb/2007	05/Mar/2007	5.3	32.1	5.4	15.6	215.0	43.9	16.3	227.1	5.0	<1.0	6.2	5.4	35.1	56.0
05/Mar/2007	19/Mar/2007	5.6	65.5	2.6	<0.7	582.8	122.8	30.4	644.0	10.7	<1.0	0.0	2.5	82.6	77.0
19/Mar/2007	02/Apr/2007	6.0	39.1	16.8	18.5	248.7	51.9	37.1	268.7	9.5	<1.0	9.2	0.9	42.1	6.0
02/Apr/2007	16/Apr/2007	-	-	-	-	-	-	-	-	-	-	-	-	-	0.0
16/Apr/2007	30/Apr/2007	5.8	15.2	9.5	22.3	20.7	5.3	15.8	23.4	1.6	<1.0	12.7	1.6	9.7	26.8
30/Apr/2007	14/May/2007	5.8	20.3	11.5	8.0	81.2	17.6	31.5	87.5	4.7	<1.0	10.5	1.5	10.2	26.7
14/May/2007	28/May/2007	6.0	22.5	<0.7	48.9	122.7	14.8	5.9	130.9	14.8	13.0	7.7	1.0	27.6	61.0
28/May/2007	11/Jun/2007	5.9	12.7	<0.7	5.1	15.9	5.0	21.0	19.2	<0.5	<1.0	10.8	1.3	7.0	13.8
11/Jun/2007	25/Jun/2007	4.9	20.4	22.6	27.0	13.4	3.3	11.2	13.8	0.9	<1.0	18.8	13.8	11.8	64.9
25/Jun/2007	09/Jul/2007	5.3	13.2	2.2	2.3	44.5	9.7	5.3	55.1	1.1	<1.0	7.8	4.8	9.6	76.9
09/Jul/2007	25/Jul/2007	4.7	13.1	9.0	<0.7	29.6	5.7	5.4	28.4	1.2	<1.0	9.6	20.9	10.3	79.4
25/Jul/2007	06/Aug/2007	-	-	-	-	-	-	-	-	-	-	-	-	-	0.0
06/Aug/2007	20/Aug/2007	5.1	9.9	3.2	3.6	42.2	7.9	20.6	47.2	1.0	2.8	4.9	7.9	7.0	67.6
20/Aug/2007	03/Sep/2007	5.5	16.9	3.9	10.4	71.1	12.0	11.1	75.1	3.3	2.2	8.4	3.5	11.8	22.4
03/Sep/2007	17/Sep/2007	5.6	10.4	3.6	5.5	52.2	11.4	8.5	55.4	2.8	<1.0	4.2	2.4	7.1	41.0
17/Sep/2007	01/Oct/2007	5.4	20.7	7.3	11.4	135.8	28.1	14.1	146.7	3.7	<1.0	4.3	3.9	21.6	61.4
01/Oct/2007	15/Oct/2007	5.3	19.5	17.7	26.1	49.5	10.4	9.6	52.1	2.7	<1.0	13.6	5.4	11.1	25.7
15/Oct/2007	29/Oct/2007	5.7	12.7	4.5	10.0	72.4	13.3	6.8	79.3	2.5	<1.0	3.9	2.2	23.6	45.8
29/Oct/2007	12/Nov/2007	5.5	71.8	5.3	22.0	496.0	120.6	48.2	549.5	22.9	3.0	12.0	3.2	69.6	30.1
12/Nov/2007	26/Nov/2007	5.3	35.1	12.1	15.1	223.7	44.9	15.9	240.8	6.0	<1.0	8.1	5.6	32.9	33.3
26/Nov/2007	10/Dec/2007	5.4	23.1	<0.1	<0.7	175.4	37.6	24.0	194.1	5.4	<1.0	2.0	3.6	28.2	143.5
10/Dec/2007	24/Dec/2007	4.7	22.2	16.1	26.9	89.7	16.3	9.7	95.3	5.1	2.4	11.4	20.0	-	8.0
24/Dec/2007	14/Jan/2008	5.5	56.9	4.5	16.7	470.5	99.4	26.5	509.3	10.7	<1.0	0.2	2.9	69.5	96.1
			Precipitation<weighted annual means for site(samples containing phosphate are excluded)												
5006			28.1	6.0	9.1	193.4	40.5	17.8	209.3	5.1	0.7	6.9	5.6		Total rainfall 1234.1

# Moorhouse

2007

Site Code: 5167  
 Easting: 3758  
 Northing: 5328  
 Latitude: 54 41 23 N  
 Longitude: 02 22 37 W  
 Altitude (m): 570  
 Rainfall (mm): 2308

[30 year mean 1940 - 1971]

Site Environment:  
**Very open moorland**

Other measurements:  
 DT, HNO3 Denuder, ECN, Met

Site Operator:  
**Centre for Ecology and Hydrology (Lancaster)**

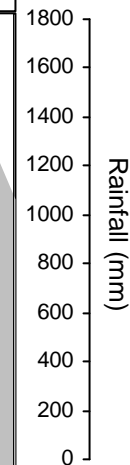
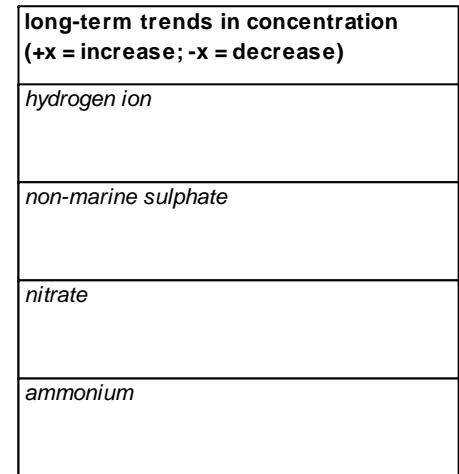
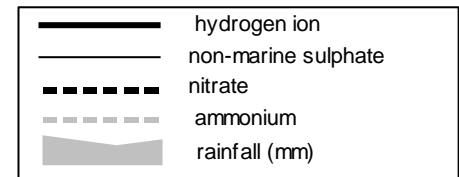

(5167) Moorhouse

Start Date	End Date	pH	SO4 (µeq/l)	NO3 (µeq/l)	NH4 (µeq/l)	Na (µeq/l)	Mg (µeq/l)	Ca (µeq/l)	Cl (µeq/l)	K (µeq/l)	PO4 (µeq/l)	Nss SO4 (µeq/l)	H+ (µeq/l)	Conductivity (S/cm)	Rainfall (mm)	
10/Jan/2007	31/Jan/2007	5.6	24.9	5.8	16.4	177.8	34.4	10.4	185.5	3.3	<1.0	3.5	2.4	30.6	94.6	
31/Jan/2007	06/Feb/2007	4.7	9.2	8.0	24.6	16.4	2.1	2.8	25.4	0.7	<1.0	7.2	20.0	-	2.6	
06/Feb/2007	21/Feb/2007	4.6	26.0	33.5	36.8	66.2	13.6	7.4	69.6	1.1	<1.0	18.1	25.1	22.8	28.7	
21/Feb/2007	07/Mar/2007	5.1	19.4	12.4	15.1	78.8	13.2	6.0	95.9	2.5	<1.0	9.9	7.8	17.9	124.8	
07/Mar/2007	21/Mar/2007	6.0	44.1	20.0	54.2	199.1	33.9	12.0	215.0	4.8	2.9	20.1	1.1	37.7	17.4	
21/Mar/2007	04/Apr/2007	4.7	75.9	151.5	132.1	35.3	11.5	27.2	44.5	5.7	<1.0	71.6	20.0	-	4.0	
04/Apr/2007	17/Apr/2007	-	-	-	-	-	-	-	-	-	-	-	-	-	0.0	
17/Apr/2007	02/May/2007	5.5	26.2	22.0	34.6	14.1	3.3	8.4	15.0	1.4	<1.0	24.5	3.2	10.2	24.4	
02/May/2007	16/May/2007	5.2	21.8	15.8	21.7	64.4	11.9	10.3	67.5	1.9	<1.0	14.1	6.3	14.8	79.1	
16/May/2007	30/May/2007	5.6	30.5	13.1	20.8	144.9	27.2	16.8	155.0	3.6	<1.0	13.0	2.5	25.4	36.7	
30/May/2007	13/Jun/2007	4.9	53.3	65.5	84.0	8.1	6.3	24.4	9.3	1.8	<1.0	52.3	13.8	21.3	38.5	
13/Jun/2007	25/Jun/2007	4.5	16.6	19.2	6.6	16.8	5.2	4.6	21.9	0.5	<1.0	14.6	31.6	13.2	110.1	
25/Jun/2007	18/Jul/2007	5.8	13.7	7.0	31.6	9.4	0.8	0.2	11.5	5.8	5.9	12.6	1.4	7.6	15.2	
18/Jul/2007	01/Aug/2007	4.9	26.4	31.6	38.9	14.9	2.9	7.2	10.0	1.4	<1.0	24.6	14.1	12.7	60.7	
01/Aug/2007	08/Aug/2007	5.5	18.5	9.7	14.4	65.9	10.2	9.3	57.5	1.7	<1.0	10.6	3.1	9.6	42.7	
08/Aug/2007	22/Aug/2007	6.6	42.0	11.5	222.0	19.7	5.3	5.4	16.5	21.5	81.0	39.6	0.2	35.3	63.0	
22/Aug/2007	05/Sep/2007	5.0	11.9	9.5	34.9	29.5	8.0	5.0	34.6	2.4	2.5	8.3	10.0	-	15.4	
05/Sep/2007	19/Sep/2007	5.9	13.0	9.9	18.8	43.5	9.1	8.1	45.9	1.6	<1.0	7.7	1.2	7.2	32.1	
19/Sep/2007	03/Oct/2007	5.2	13.8	6.9	6.7	54.1	11.6	7.0	64.5	1.4	<1.0	7.2	6.5	9.1	67.3	
03/Oct/2007	17/Oct/2007	5.1	16.7	19.9	27.0	21.4	3.9	5.2	18.2	1.2	<1.0	14.1	8.9	7.1	37.7	
17/Oct/2007	31/Oct/2007	-	-	-	-	-	-	-	-	-	-	-	-	-	0.0	
31/Oct/2007	14/Nov/2007	6.0	29.5	16.1	43.6	137.8	21.3	7.7	147.6	3.4	<1.0	12.9	1.0	24.2	16.5	
14/Nov/2007	28/Nov/2007	4.4	37.5	52.2	38.7	104.8	23.6	11.2	107.9	2.7	2.8	24.9	41.7	34.2	46.8	
28/Nov/2007	12/Dec/2007	-	-	-	-	-	-	-	-	-	-	-	-	-	0.0	
12/Dec/2007	24/Dec/2007	-	-	-	-	-	-	-	-	-	-	-	-	-	0.0	
24/Dec/2007	09/Jan/2008	5.1	20.3	10.5	12.1	102.9	19.8	6.2	112.1	2.6	2.2	8.0	7.6	18.9	140.9	
5167		Precipitation<weighted annual means for site(samples containing phosphate are excluded)														Total rainfall
			23.0	18.6	22.8	74.3	14.5	8.4	80.3	2.2	1.0	14.1	11.3		1099.3	

# Loch Dee

2007

Site Code: 5107  
 Easting: 2468  
 Northing: 5779  
 Latitude: 55 04 19 N  
 Longitude: 04 23 59 W  
 Altitude (m): 230  
 Rainfall (mm): 2494  
 [30 year mean 1940 - 1971]

Site Environment:  
 Open moorland

Other measurements:  
 DT

Site Operator:  
 SEPA West Region

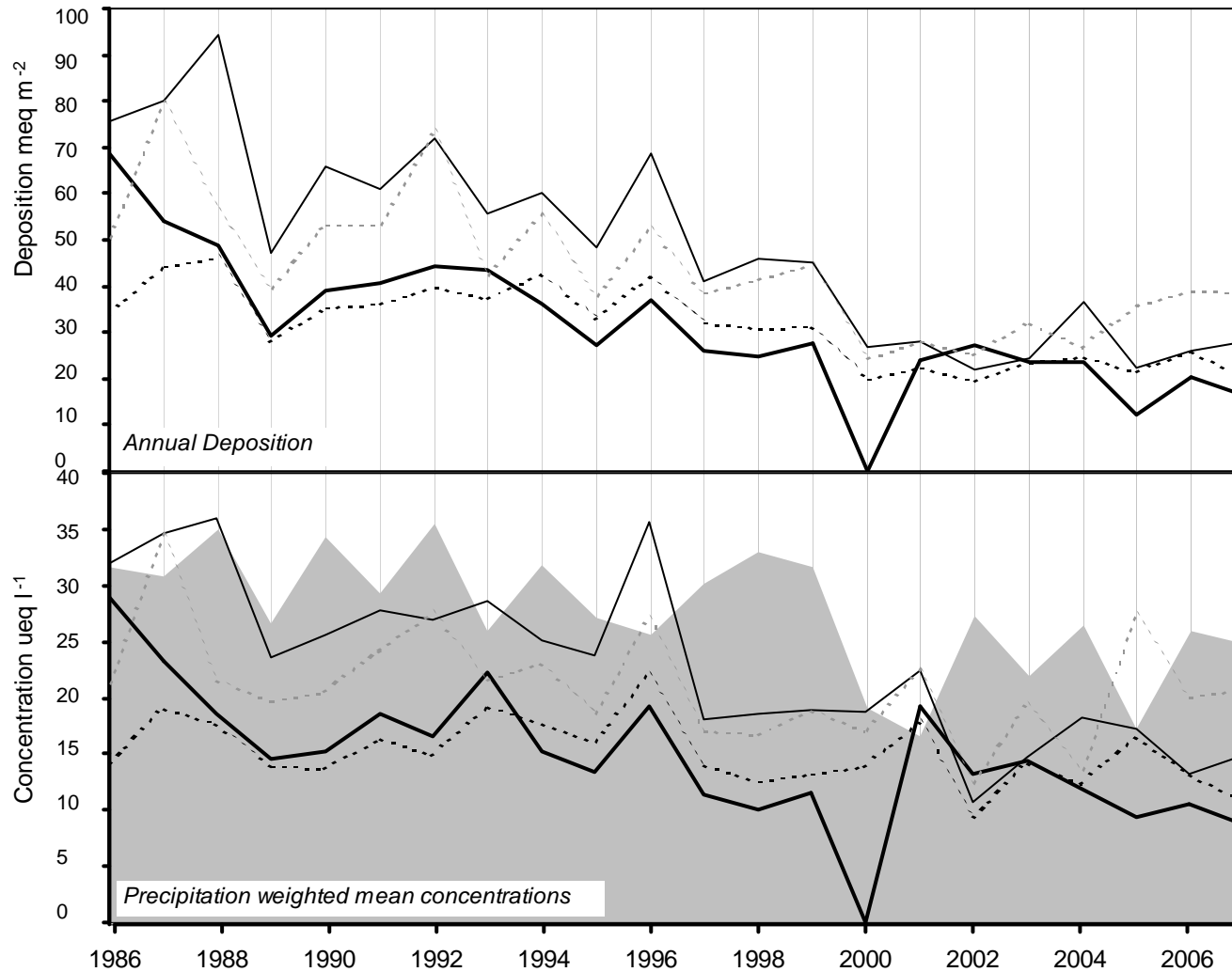
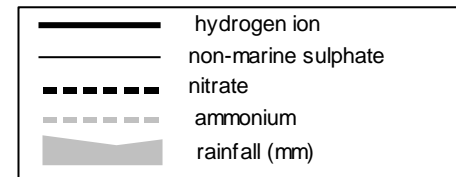

long-term trends in concentration (+x = increase; -x = decrease)	
<i>hydrogen ion</i>	-0.60 ueq/l (-2.78 %/year): 21 years' data ++ Moderately strong trend detected
<i>non-marine sulphate</i>	-0.95 ueq/l (-2.87 %/year): 22 years' data +++ Strong trend detected
<i>nitrate</i>	-0.16 ueq/l (-0.96 %/year): 22 years' data - No significant trend detected
<i>ammonium</i>	-0.30 ueq/l (-1.25 %/year): 22 years' data - No significant trend detected

(5107) Loch Dee

Start Date	End Date	pH	SO4 (µeq/l)	NO3 (µeq/l)	NH4 (µeq/l)	Na (µeq/l)	Mg (µeq/l)	Ca (µeq/l)	Cl (µeq/l)	K (µeq/l)	PO4 (µeq/l)	Nss SO4 (µeq/l)	H+ (µeq/l)	Conductivity (S/cm)	Rainfall (mm)	
10/Jan/2007	25/Jan/2007	5.5	46.4	14.3	10.7	361.5	77.4	15.9	390.4	4.9	3.5	2.9	3.0	54.6	124.9	
25/Jan/2007	15/Feb/2007	5.1	32.6	19.6	34.3	103.1	18.5	5.4	124.5	3.9	<1.0	20.1	7.6	23.9	62.4	
15/Feb/2007	28/Feb/2007	5.7	47.2	10.9	52.9	101.1	16.0	8.0	110.8	13.1	3.3	35.0	2.1	23.6	155.3	
28/Feb/2007	15/Mar/2007	5.7	2.3	0.8	13.1	144.1	27.6	6.7	13.9	4.7	<1.0	0.0	1.8	24.9	172.9	
15/Mar/2007	29/Mar/2007	5.4	73.5	7.0	11.5	612.8	134.0	28.7	657.5	10.7	<1.0	0.0	4.4	91.8	38.7	
29/Mar/2007	11/Apr/2007	5.6	25.4	16.3	32.2	48.2	10.3	9.2	47.7	2.7	<1.0	19.6	2.5	13.6	13.4	
11/Apr/2007	25/Apr/2007	5.2	24.9	19.0	32.1	25.4	6.2	8.8	28.1	2.4	<1.0	21.8	6.3	11.1	80.4	
25/Apr/2007	09/May/2007	5.5	36.4	21.4	42.0	74.4	15.5	12.1	78.7	3.8	<1.0	27.4	2.9	19.9	25.5	
09/May/2007	29/May/2007	6.2	33.1	6.6	97.1	52.8	4.9	2.5	59.2	11.9	46.8	26.8	0.7	23.7	92.7	
29/May/2007	15/Jun/2007	6.8	58.9	24.4	326.7	20.4	3.0	1.8	28.3	42.5	115.6	56.5	0.2	54.0	57.4	
15/Jun/2007	27/Jun/2007	4.4	22.2	27.9	18.2	10.8	3.2	4.6	12.9	0.5	<1.0	20.9	36.3	13.8	69.2	
27/Jun/2007	10/Jul/2007	4.9	11.8	5.2	4.4	20.3	3.7	1.8	23.1	0.9	<1.0	9.3	12.0	7.0	94.8	
10/Jul/2007	24/Jul/2007	6.9	65.2	8.8	505.2	14.9	10.0	7.3	21.0	49.8	195.2	63.4	0.1	70.3	66.0	
24/Jul/2007	16/Aug/2007	4.8	10.7	6.5	10.0	25.9	5.0	6.3	28.9	1.0	<1.0	7.6	15.8	6.7	185.7	
16/Aug/2007	30/Aug/2007	5.9	16.0	5.6	67.5	24.6	2.1	1.0	30.8	6.1	11.0	13.0	1.3	9.3	68.3	
30/Aug/2007	19/Sep/2007	7.2	67.5	8.6	480.9	65.4	6.4	2.4	76.4	55.9	142.6	59.6	0.1	68.4	104.9	
19/Sep/2007	04/Oct/2007	-	-	-	-	-	-	-	-	-	-	-	-	-	0.0	
04/Oct/2007	16/Oct/2007	-	-	-	-	-	-	-	-	-	-	-	-	-	0.0	
16/Oct/2007	02/Nov/2007	7.1	641.4	0.3	9431.3	228.6	101.0	92.9	251.5	557.8	1642.8	613.9	0.1	1162.0	66.5	
02/Nov/2007	14/Nov/2007	7.3	162.8	6.7	1665.5	273.3	66.1	21.8	316.0	162.5	284.5	129.9	0.0	256.0	14.8	
14/Nov/2007	13/Dec/2007	7.0	64.6	8.3	708.0	103.7	20.5	16.3	117.5	59.2	156.8	52.1	0.1	101.8	182.5	
13/Dec/2007	09/Jan/2008	5.0	30.6	11.3	16.6	190.8	38.1	9.7	205.6	4.3	2.1	7.6	9.3	31.9	185.7	
			Precipitation<weighted annual means for site(samples containing phosphate are excluded)													Total rainfall
5107			26.5	10.9	20.8	135.2	27.2	8.6	126.7	4.6	1.4	15.0	8.8		1862.1	

# Beaghs Burn

2007

Site Code: 5155  
 Easting: 1345  
 Northing: 5865  
 Latitude: 55 05 00 N  
 Longitude: 00 06 11 W  
 Altitude (m): 250  
 Rainfall (mm): 1550  
 [30 year mean 1940 - 1971]

Site Environment:  
 Turbarry, open peat cutting.

Other measurements:  
 UKAWMN

Site Operator:  
 Agri-Food and Biosciences Institute, NI

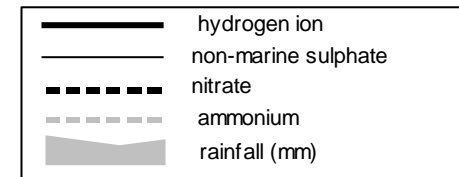
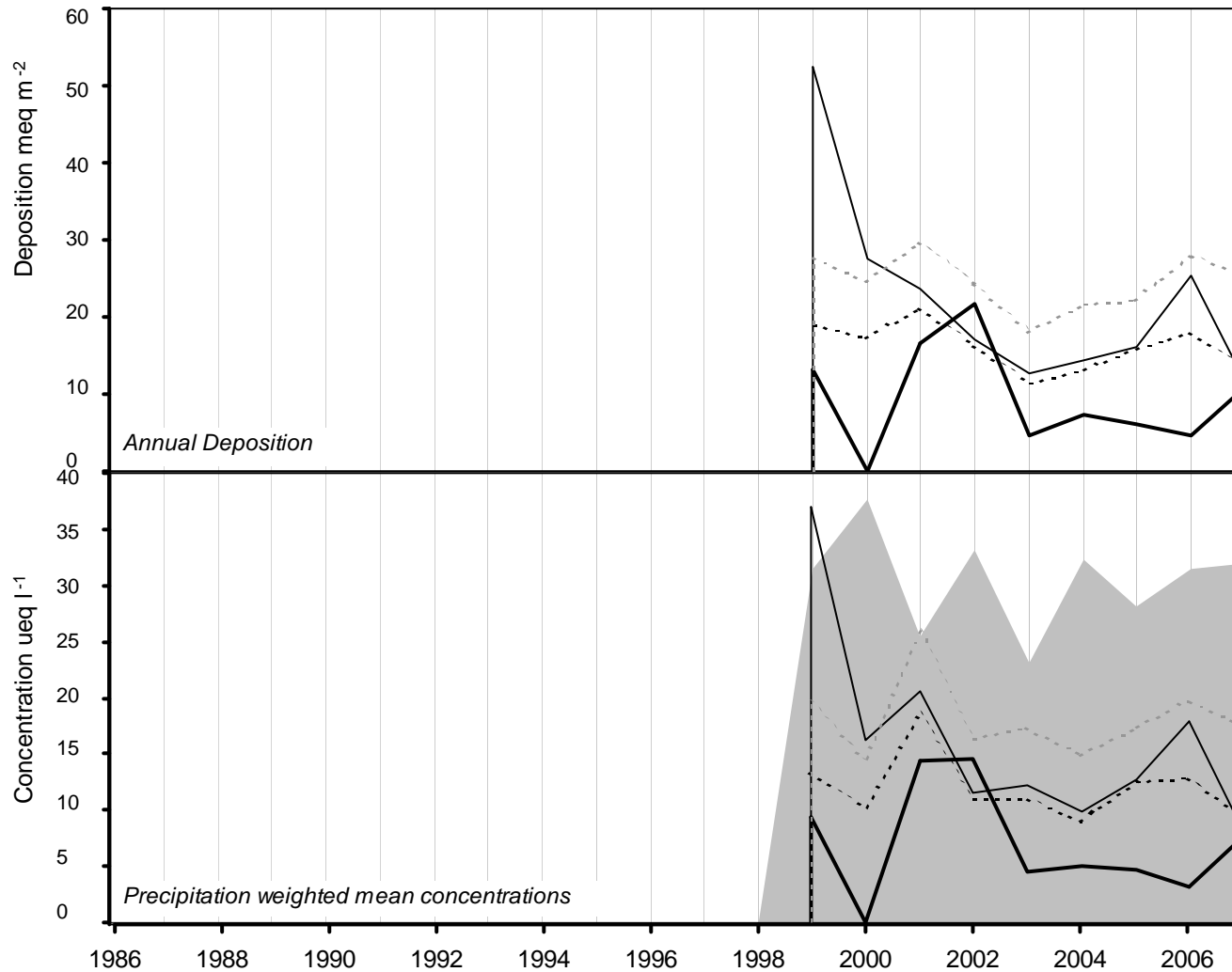

long-term trends in concentration (+x = increase; -x = decrease)	
<i>hydrogen ion</i>	-1.53 ueq/l (-4.69 %/year): 8 years' data - No significant trend detected
<i>non-marine sulphate</i>	-2.14 ueq/l (-4.07 %/year): 9 years' data + Significant trend detected
<i>nitrate</i>	-0.14 ueq/l (-0.97 %/year): 9 years' data - No significant trend detected
<i>ammonium</i>	-0.03 ueq/l (-0.16 %/year): 9 years' data - No significant trend detected



## (5155) Beaghs Burn

Start Date	End Date	pH	SO4 (µeq/l)	NO3 (µeq/l)	NH4 (µeq/l)	Na (µeq/l)	Mg (µeq/l)	Ca (µeq/l)	Cl (µeq/l)	K (µeq/l)	PO4 (µeq/l)	Nss SO4 (µeq/l)	H+ (µeq/l)	Conductivity (S/cm)	Rainfall (mm)
09/Jan/2007	23/Jan/2007	5.7	44.4	4.1	10.7	421.1	78.3	12.4	427.7	5.2	3.4	0.0	2.0	55.8	83.4
23/Jan/2007	06/Feb/2007	5.8	28.8	5.9	24.0	157.5	25.5	6.2	217.7	2.9	<1.0	9.9	1.7	33.9	22.4
06/Feb/2007	20/Feb/2007	4.5	44.9	41.1	48.3	179.9	39.1	10.3	194.5	4.5	<1.0	23.3	34.7	41.3	57.2
20/Feb/2007	06/Mar/2007	5.7	22.1	5.5	14.0	173.0	31.5	8.2	181.6	3.9	<1.0	1.2	2.2	27.0	94.6
06/Mar/2007	20/Mar/2007	5.9	63.7	4.3	17.2	532.4	107.3	24.3	598.8	9.2	<1.0	0.0	1.2	76.2	67.9
20/Mar/2007	03/Apr/2007	4.8	25.5	24.3	31.4	63.6	14.5	12.0	62.8	2.6	<1.0	17.8	15.5	18.0	18.9
03/Apr/2007	16/Apr/2007	4.7	49.5	28.3	68.2	118.0	20.3	45.5	105.6	29.0	<1.0	35.3	20.0	-	1.2
16/Apr/2007	01/May/2007	5.8	17.5	12.0	39.7	27.6	3.8	7.6	31.7	1.6	<1.0	14.1	1.6	11.0	36.8
01/May/2007	15/May/2007	10.2	15.0	6.6	19.2	52.1	7.3	3.8	53.8	4.0	<1.0	8.7	0.0	0.7	70.5
15/May/2007	29/May/2007	5.6	12.4	3.5	15.5	62.3	9.3	3.8	66.6	1.8	<1.0	4.9	2.6	12.6	57.3
29/May/2007	12/Jun/2007	5.1	5.0	7.2	1.5	8.1	1.8	4.9	7.0	0.8	<1.0	4.0	8.1	4.6	27.0
12/Jun/2007	26/Jun/2007	4.6	32.2	19.8	23.6	76.7	15.7	7.3	82.3	2.1	<1.0	22.9	25.7	23.8	114.2
26/Jun/2007	10/Jul/2007	5.1	12.9	5.3	11.5	25.4	4.2	4.4	35.5	1.2	<1.0	9.8	7.2	7.0	31.4
10/Jul/2007	24/Jul/2007	4.9	17.6	7.7	2.3	28.0	3.9	3.2	24.0	1.4	<1.0	14.2	13.8	9.6	33.9
24/Jul/2007	07/Aug/2007	5.7	8.9	2.7	13.7	44.7	4.8	3.0	41.3	1.5	<1.0	3.5	1.9	5.9	72.0
07/Aug/2007	21/Aug/2007	5.2	14.8	8.4	12.5	67.5	12.0	8.8	75.4	2.2	<1.0	6.6	6.5	9.8	82.3
21/Aug/2007	04/Sep/2007	5.0	14.3	3.5	22.6	67.9	8.9	9.5	77.2	5.4	<1.0	6.1	10.0	-	19.3
04/Sep/2007	18/Sep/2007	6.4	17.3	7.7	62.9	58.2	10.7	4.7	62.9	2.4	<1.0	10.3	0.4	9.7	13.3
18/Sep/2007	02/Oct/2007	6.2	27.5	4.9	21.8	197.8	39.6	27.3	219.1	5.3	<1.0	3.7	0.6	32.9	8.7
02/Oct/2007	16/Oct/2007	5.6	9.0	8.6	20.3	18.5	2.2	1.7	18.5	1.2	<1.0	6.7	2.4	5.1	39.8
16/Oct/2007	30/Oct/2007	6.0	21.7	8.3	26.7	135.0	23.3	12.0	145.0	3.7	2.8	5.4	1.0	20.1	31.4
30/Oct/2007	13/Nov/2007	5.6	57.0	4.5	21.2	432.2	91.2	25.0	455.8	8.7	2.8	4.9	2.6	60.8	69.9
13/Nov/2007	27/Nov/2007	4.7	39.6	23.7	21.1	237.9	50.2	15.2	254.2	5.2	2.8	10.9	18.6	42.2	49.8
27/Nov/2007	11/Dec/2007	5.5	23.3	2.5	7.7	183.1	35.3	8.9	198.9	3.4	<1.0	1.2	3.1	24.9	103.0
11/Dec/2007	31/Dec/2007	5.6	18.8	13.4	20.6	108.1	17.8	4.6	111.1	2.4	2.2	5.7	2.6	18.2	48.9
31/Dec/2007	22/Jan/2008	5.2	21.4	6.4	8.9	156.6	33.1	10.0	173.4	3.7	<1.0	2.6	6.0	24.3	183.1
			Precipitation<weighted annual means for site(samples containing phosphate are excluded)												
5155			26.4	9.3	17.6	162.8	31.6	9.6	175.2	3.7	1.0	8.0	7.7		Total rainfall 1438.4

# Redesdale

2007

Site Code: 5109  
 Easting: 3833  
 Northing: 5954  
 Latitude: 55 14 59 N  
 Longitude: 02 15 46 W  
 Altitude (m): 240  
 Rainfall (mm): 618  
 [30 year mean 1940 - 1971]

Site Environment:  
 Open moorland, very open sheep farming land

Other measurements:  
 DT

Site Operator:  
 ADAS Redesdale

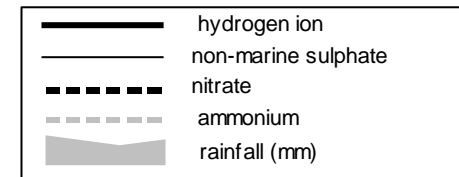
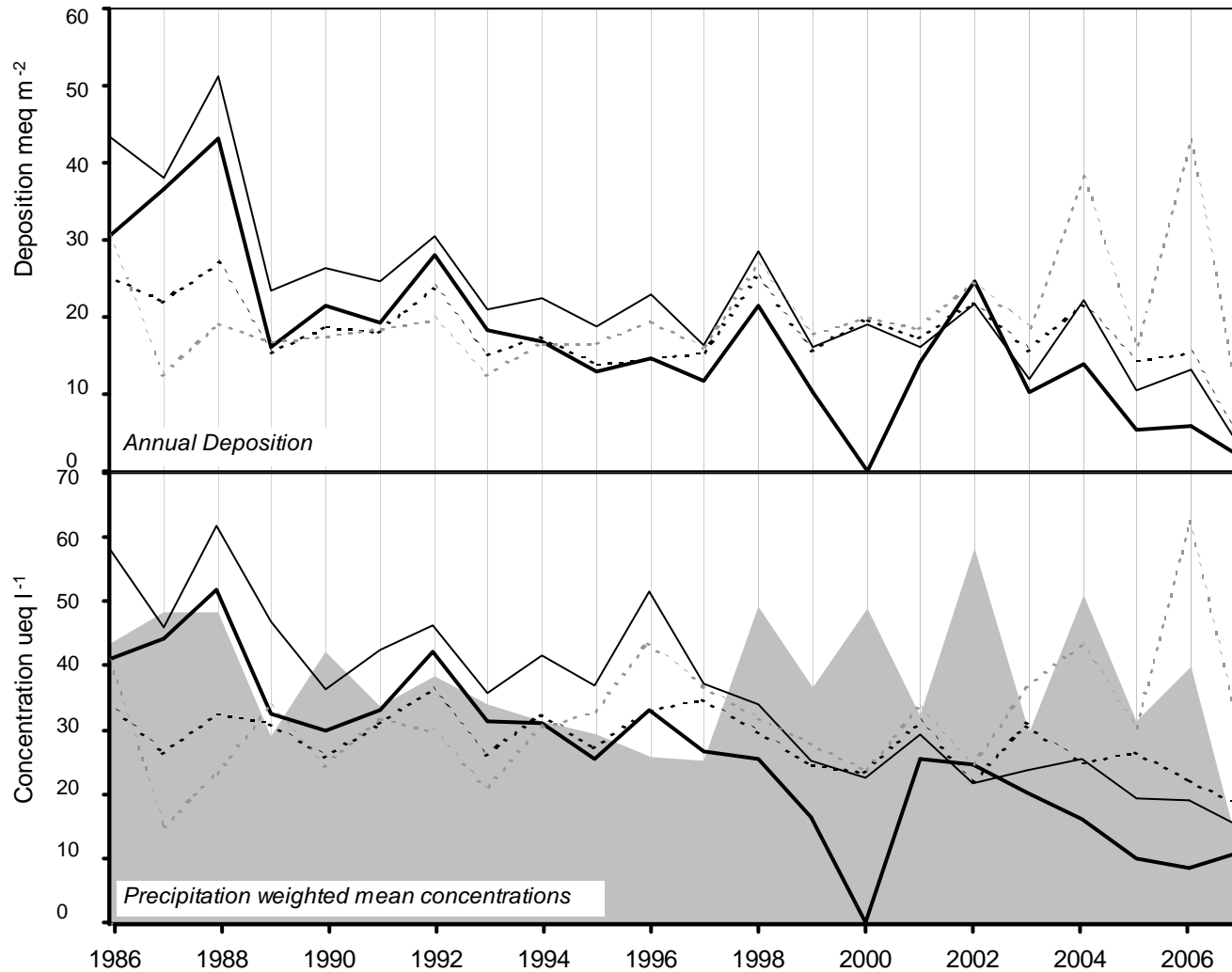

long-term trends in concentration (+x = increase; -x = decrease)	
<i>hydrogen ion</i>	-1.68 ueq/l (-3.79 %/year): 20 years' data ++++ Very strong trend detected
<i>non-marine sulphate</i>	-1.79 ueq/l (-3.31 %/year): 21 years' data ++++ Very strong trend detected
<i>nitrate</i>	-0.33 ueq/l (-1.02 %/year): 21 years' data + Significant trend detected
<i>ammonium</i>	0.72 ueq/l (2.85 %/year): 21 years' data - No significant trend detected

(5109) Redesdale

Start Date	End Date	pH	SO4 (µeq/l)	NO3 (µeq/l)	NH4 (µeq/l)	Na (µeq/l)	Mg (µeq/l)	Ca (µeq/l)	Cl (µeq/l)	K (µeq/l)	PO4 (µeq/l)	Nss SO4 (µeq/l)	H+ (µeq/l)	Conductivity (S/cm)	Rainfall (mm)
09/Jan/2007	23/Jan/2007	5.6	29.8	6.1	13.1	261.9	51.0	12.1	263.4	3.4	<1.0	0.0	2.6	36.6	51.7
23/Jan/2007	06/Feb/2007	-	-	-	-	-	-	-	-	-	-	-	-	-	0.0
06/Feb/2007	20/Feb/2007	4.3	46.2	47.4	44.5	128.4	27.2	10.8	133.6	3.9	<1.0	30.7	52.5	40.6	19.2
20/Feb/2007	06/Mar/2007	5.2	18.3	19.9	30.8	78.8	13.7	5.4	75.1	1.9	<1.0	8.8	6.0	16.9	47.7
06/Mar/2007	22/Mar/2007	5.7	43.0	17.6	38.6	246.1	45.8	17.2	270.1	5.8	<1.0	13.4	1.9	43.5	13.5
5109		Precipitation-weighted annual means for site(samples containing phosphate are excluded)													
			29.4	18.2	26.6	174.8	33.6	10.0	177.3	3.2	0.5	14.8	11.0	Total rainfall 132.1	

# Percy's Cross

2007

Site Code: 5168  
 Easting: 3880  
 Northing: 5935  
 Latitude: 55 14 8 N  
 Longitude: 2 11 25 W  
 Altitude (m): 170  
 Rainfall (mm): 883

[30 year mean 1940 - 1971]

Site Environment:

Open Moorland. Relocated from Redesdale site.

Other measurements:

Site Operator:

Independent

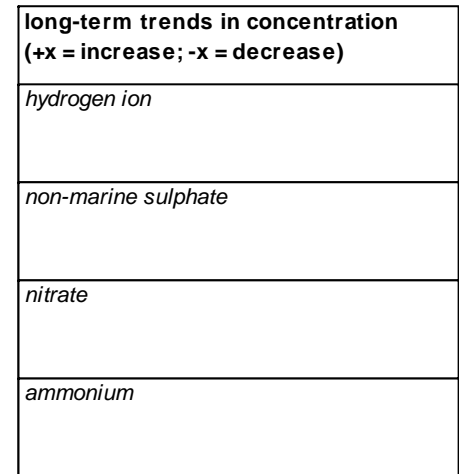
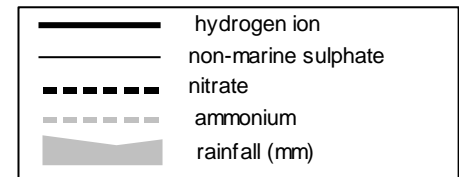
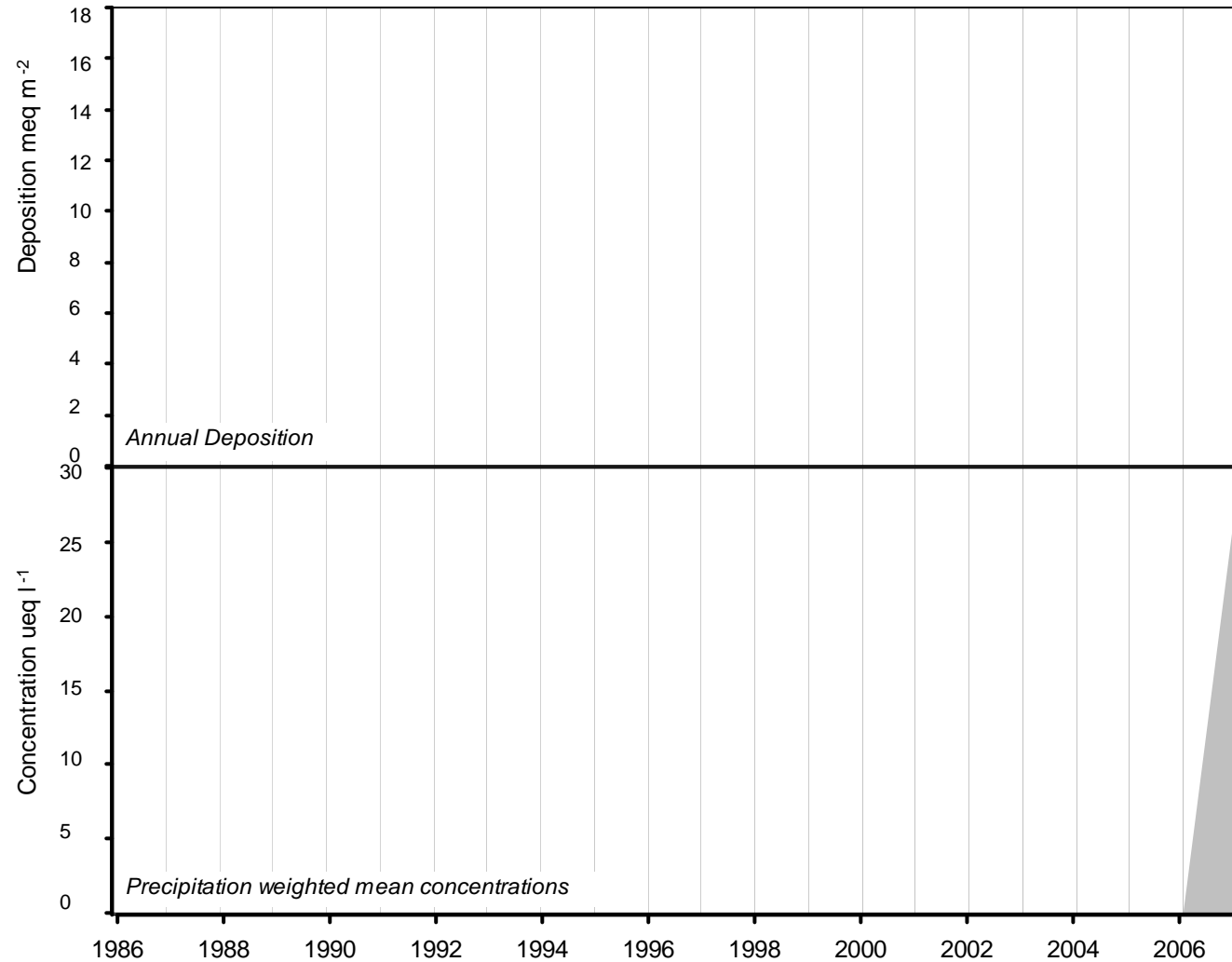

(5168) Percy's Cross

Start Date	End Date	pH	SO4 (µeq/l)	NO3 (µeq/l)	NH4 (µeq/l)	Na (µeq/l)	Mg (µeq/l)	Ca (µeq/l)	Cl (µeq/l)	K (µeq/l)	PO4 (µeq/l)	Nss SO4 (µeq/l)	H+ (µeq/l)	Conductivity (S/cm)	Rainfall (mm)	
22/Mar/2007	03/Apr/2007	4.1	161.8	259.2	252.6	134.2	36.3	78.4	144.6	15.7	<1.0	145.6	79.4	96.7	6.9	
03/Apr/2007	17/Apr/2007	-	-	-	-	-	-	-	-	-	-	-	-	-	0.0	
17/Apr/2007	01/May/2007	4.7	68.5	44.4	108.1	87.9	16.5	19.4	96.9	4.8	<1.0	57.9	20.0	-	7.0	
01/May/2007	15/May/2007	4.7	32.8	29.5	32.6	66.3	14.8	19.6	58.1	3.3	2.1	24.8	19.1	21.2	17.0	
15/May/2007	29/May/2007	4.7	183.4	124.8	159.3	699.6	125.6	88.6	711.4	21.3	20.5	99.1	20.0	-	2.0	
29/May/2007	12/Jun/2007	4.7	98.5	127.2	151.4	19.9	8.5	44.5	17.3	3.7	<1.0	96.1	20.0	-	5.5	
12/Jun/2007	26/Jun/2007	4.4	31.6	33.8	28.4	23.1	5.1	5.4	27.2	1.7	<1.0	28.9	43.7	21.2	109.4	
26/Jun/2007	10/Jul/2007	4.9	5.7	7.3	4.7	3.2	1.2	1.1	4.6	0.4	<1.0	5.3	12.0	4.5	89.7	
10/Jul/2007	24/Jul/2007	4.5	29.1	25.2	18.8	19.3	4.9	7.3	15.5	1.6	<1.0	26.7	32.4	16.1	35.5	
24/Jul/2007	07/Aug/2007	6.2	26.3	24.1	55.0	51.6	4.8	4.8	39.3	3.1	<1.0	20.1	0.7	14.7	14.9	
07/Aug/2007	21/Aug/2007	5.0	19.3	17.3	36.5	28.4	5.5	11.9	24.3	4.1	2.6	15.9	10.0	-	27.7	
21/Aug/2007	04/Sep/2007	-	-	-	-	-	-	-	-	-	-	-	-	-	0.0	
04/Sep/2007	18/Sep/2007	-	-	-	-	-	-	-	-	-	-	-	-	-	0.0	
18/Sep/2007	02/Oct/2007	5.7	43.0	20.0	51.5	212.7	42.3	17.9	237.1	6.9	<1.0	17.4	2.0	39.9	14.7	
02/Oct/2007	30/Oct/2007	5.3	28.2	31.3	52.9	34.5	8.9	8.0	36.5	1.5	<1.0	24.1	5.5	12.4	25.6	
30/Oct/2007	13/Nov/2007	-	-	-	-	-	-	-	-	-	-	-	-	-	0.0	
13/Nov/2007	27/Nov/2007	4.3	43.2	60.8	38.4	152.3	32.2	22.4	164.3	3.4	<1.0	24.9	53.7	43.7	43.6	
27/Nov/2007	11/Dec/2007	4.9	15.1	8.0	8.6	72.2	14.2	7.1	78.4	1.8	<1.0	6.4	12.0	16.3	45.0	
11/Dec/2007	24/Dec/2007	5.0	49.4	43.6	72.6	78.0	14.2	13.9	77.3	3.9	<1.0	40.0	10.0	-	3.8	
24/Dec/2007	12/Jan/2008	4.8	17.7	11.1	11.0	79.3	15.5	5.4	85.2	2.0	<1.0	8.2	15.5	17.0	115.7	
			Precipitation<weighted annual means for site(samples containing phosphate are excluded)													Total rainfall
5168			26.3	26.6	27.8	55.5	11.5	9.0	59.1	2.3	0.6	19.6	23.7		563.8	

# Eskdalemuir

2007

Site Code: 5002  
 Easting: 3235  
 Northing: 6030  
 Latitude: 55 18 54 N  
 Longitude: 03 12 20 W  
 Altitude (m): 259  
 Rainfall (mm): 1745  
 [30 year mean 1940 - 1971]

Site Environment:  
 Open moorland, Met Office Observatory

Other measurements:  
 Daily Bulk, DT (triplicate), Daily SO<sub>4</sub>, HNO<sub>3</sub> Denuder,  
 ozone, Met, EMEP

Site Operator:  
 Met Office

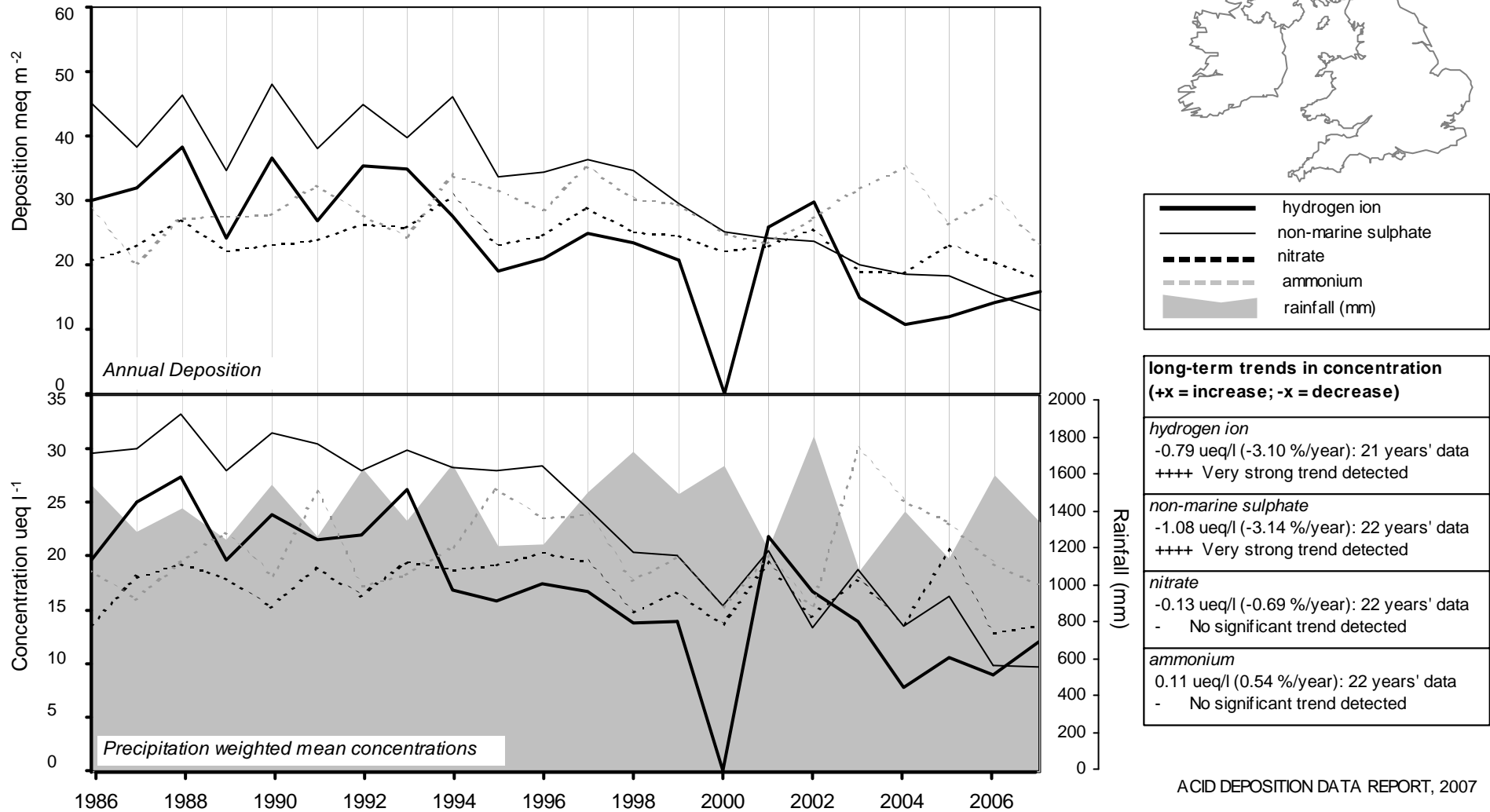

(5002) Eskdalemuir

Start Date	End Date	pH	SO4 (µeq/l)	NO3 (µeq/l)	NH4 (µeq/l)	Na (µeq/l)	Mg (µeq/l)	Ca (µeq/l)	Cl (µeq/l)	K (µeq/l)	PO4 (µeq/l)	Nss SO4 (µeq/l)	H+ (µeq/l)	Conductivity (S/cm)	Rainfall (mm)
10/Jan/2007	24/Jan/2007	5.4	32.0	5.2	12.7	260.4	50.9	10.2	277.7	3.5	<1.0	0.6	3.8	39.1	127.4
24/Jan/2007	07/Feb/2007	4.7	49.1	24.3	73.7	175.0	25.0	22.1	189.4	15.3	<1.0	28.0	20.0	-	3.9
07/Feb/2007	21/Feb/2007	4.7	28.3	28.7	36.8	72.6	15.3	7.0	76.5	1.8	<1.0	19.6	21.9	21.7	48.0
21/Feb/2007	07/Mar/2007	5.5	17.7	10.7	22.0	91.3	16.1	5.3	99.5	2.4	<1.0	6.7	3.2	16.5	125.4
07/Mar/2007	21/Mar/2007	5.0	20.4	10.4	20.8	177.6	35.6	9.2	107.7	4.5	<1.0	0.0	9.5	30.4	54.6
21/Mar/2007	04/Apr/2007	4.5	85.3	141.9	115.6	118.1	21.6	34.8	83.5	5.9	<1.0	71.1	34.7	49.8	5.7
04/Apr/2007	18/Apr/2007	-	-	-	-	-	-	-	-	-	-	-	-	-	0.0
18/Apr/2007	02/May/2007	5.5	37.6	32.8	56.8	28.5	7.4	11.4	29.4	1.8	<1.0	34.2	3.0	14.7	29.5
02/May/2007	16/May/2007	5.2	19.3	11.7	28.2	55.9	9.9	4.2	50.6	2.2	<1.0	12.6	7.1	13.5	76.9
16/May/2007	30/May/2007	5.5	24.9	13.1	26.8	122.6	22.5	10.3	136.1	3.9	<1.0	10.1	3.5	22.8	37.4
30/May/2007	13/Jun/2007	-	-	-	-	-	-	-	-	-	-	-	-	-	0.0
13/Jun/2007	27/Jun/2007	4.7	15.4	17.2	8.9	17.4	7.1	6.2	20.1	0.8	<1.0	13.3	20.0	11.5	64.7
27/Jun/2007	11/Jul/2007	6.0	13.9	6.8	40.0	6.5	0.8	<0.4	10.0	4.5	11.2	13.1	1.1	6.2	89.6
11/Jul/2007	25/Jul/2007	4.8	10.5	9.4	4.8	10.6	1.2	1.3	7.0	0.8	<1.0	9.2	15.8	6.9	83.6
25/Jul/2007	08/Aug/2007	5.1	12.5	4.9	6.5	53.6	9.3	5.5	56.7	1.0	<1.0	6.0	8.1	8.5	53.0
08/Aug/2007	22/Aug/2007	4.6	11.4	12.3	9.3	19.8	5.5	5.9	21.5	0.8	<1.0	9.0	24.0	7.1	74.0
22/Aug/2007	05/Sep/2007	4.5	11.2	<0.7	0.9	25.5	6.6	7.9	21.9	1.0	<1.0	8.2	35.5	8.5	9.6
05/Sep/2007	19/Sep/2007	5.4	11.2	7.5	15.6	39.5	9.3	6.6	42.1	1.1	<1.0	6.4	4.5	6.7	40.3
19/Sep/2007	03/Oct/2007	-	-	-	-	-	-	-	-	-	-	-	-	-	0.0
03/Oct/2007	17/Oct/2007	4.5	35.3	42.7	37.9	43.7	9.6	6.3	41.7	2.1	1.6	30.0	33.9	25.8	19.5
17/Oct/2007	31/Oct/2007	4.8	29.0	33.6	34.0	93.5	19.2	10.0	94.3	3.9	3.8	17.7	17.0	23.1	34.2
31/Oct/2007	14/Nov/2007	5.1	31.3	12.7	20.5	165.1	34.4	13.6	177.7	4.1	<1.0	11.4	7.8	26.5	14.7
14/Nov/2007	28/Nov/2007	4.6	25.0	28.7	19.1	82.5	17.5	11.2	85.7	1.9	<1.0	15.1	26.3	21.2	49.7
28/Nov/2007	12/Dec/2007	5.0	18.6	4.3	4.9	116.1	23.5	7.8	127.0	3.5	<1.0	4.6	9.8	22.1	92.1
12/Dec/2007	26/Dec/2007	4.8	34.7	26.6	29.0	165.6	34.6	11.8	177.7	4.1	2.2	14.8	16.2	31.4	26.5
26/Dec/2007	09/Jan/2008	4.9	17.3	9.9	8.7	99.5	19.5	5.6	106.3	2.4	2.1	5.3	12.6	18.7	164.1
5002			20.9	13.7	17.4	96.4	19.1	7.2	98.5	2.4	0.8	9.7	12.1		Total rainfall 1324.5

# Whiteadder

2007

Site Code: 5106  
 Easting: 3664  
 Northing: 6633  
 Latitude: 55 51 42 N  
 Longitude: 03 32 13 W  
 Altitude (m): 250  
 Rainfall (mm): 1009  
 [30 year mean 1940 - 1971]

Site Environment:  
 Open moorland

Other measurements:  
 DT

Site Operator:  
 East of Scotland Water

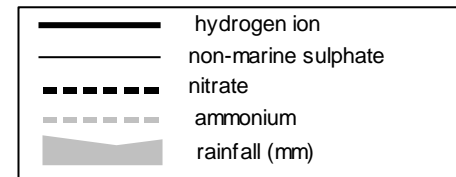

long-term trends in concentration (+x = increase; -x = decrease)	
<i>hydrogen ion</i>	-1.08 ueq/l (-2.61 %/year): 20 years' data +++ Strong trend detected
<i>non-marine sulphate</i>	-1.68 ueq/l (-3.20 %/year): 21 years' data ++++ Very strong trend detected
<i>nitrate</i>	-0.46 ueq/l (-1.35 %/year): 21 years' data + Significant trend detected
<i>ammonium</i>	-0.21 ueq/l (-0.78 %/year): 21 years' data - No significant trend detected

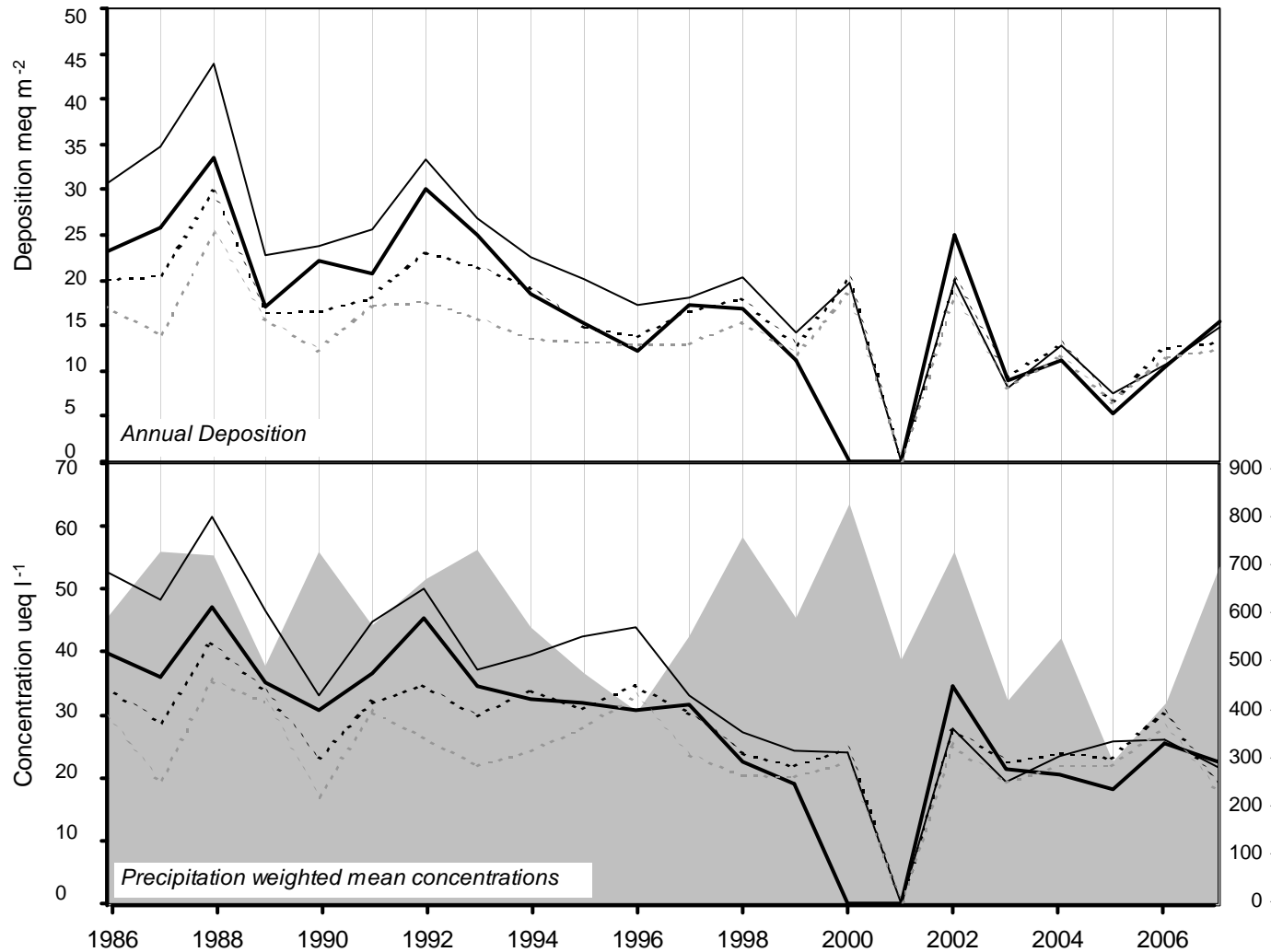



(5106) Whiteadder

Start Date	End Date	pH	SO4 (µeq/l)	NO3 (µeq/l)	NH4 (µeq/l)	Na (µeq/l)	Mg (µeq/l)	Ca (µeq/l)	Cl (µeq/l)	K (µeq/l)	PO4 (µeq/l)	Nss SO4 (µeq/l)	H+ (µeq/l)	Conductivity (S/cm)	Rainfall (mm)	
04/Jan/2007	18/Jan/2007	5.4	23.3	6.9	9.6	167.0	32.0	9.3	173.6	3.2	<1.0	3.2	3.6	26.6	29.1	
18/Jan/2007	01/Feb/2007	5.4	28.2	7.5	<0.7	20.1	3.3	1.3	214.5	0.5	<1.0	25.8	4.2	33.2	15.1	
01/Feb/2007	16/Feb/2007	4.3	50.7	41.9	35.0	185.9	41.7	15.8	203.4	4.8	<1.0	28.3	51.3	44.0	28.9	
16/Feb/2007	01/Mar/2007	4.7	18.5	23.3	23.0	28.4	5.6	4.7	33.9	2.1	<1.0	15.1	19.5	14.2	32.4	
01/Mar/2007	14/Mar/2007	4.7	20.8	18.5	13.0	78.1	15.8	10.9	84.7	1.9	<1.0	11.4	20.0	-	15.1	
14/Mar/2007	27/Mar/2007	4.7	98.7	41.6	20.0	603.4	101.3	60.5	578.6	24.5	7.2	26.0	20.0	-	3.0	
27/Mar/2007	12/Apr/2007	4.1	89.3	143.3	138.0	69.5	20.1	36.6	66.3	7.7	<1.0	81.0	74.1	56.6	11.3	
12/Apr/2007	26/Apr/2007	4.7	108.7	102.0	78.1	166.6	46.3	69.8	134.2	10.4	4.6	88.6	20.0	-	3.7	
26/Apr/2007	10/May/2007	5.8	36.6	26.0	31.2	73.0	15.5	15.3	71.6	4.8	<1.0	27.9	1.6	13.1	7.4	
10/May/2007	24/May/2007	4.6	55.9	37.8	45.5	102.2	19.1	14.4	102.5	6.3	<1.0	43.6	22.9	29.8	8.3	
24/May/2007	07/Jun/2007	6.7	47.2	23.5	23.2	81.6	21.8	100.1	69.3	4.3	<1.0	37.4	0.2	26.9	30.2	
07/Jun/2007	20/Jun/2007	4.6	31.8	21.1	18.2	26.6	5.7	10.7	27.3	1.1	<1.0	28.6	28.2	16.2	55.9	
20/Jun/2007	09/Jul/2007	4.5	25.7	13.1	5.3	24.3	6.7	5.2	30.2	1.0	<1.0	22.8	30.9	14.5	68.5	
09/Jul/2007	19/Jul/2007	6.1	22.3	9.3	41.2	18.3	1.6	1.6	14.1	5.7	3.7	20.1	0.8	7.8	48.6	
19/Jul/2007	01/Aug/2007	4.4	23.1	10.3	3.0	29.1	6.1	8.5	26.0	1.6	<1.0	19.6	36.3	10.3	49.7	
01/Aug/2007	07/Sep/2007	4.5	24.9	16.6	10.7	36.4	7.2	21.9	41.3	1.1	<1.0	20.5	30.9	13.2	59.7	
07/Sep/2007	17/Sep/2007	-	-	-	-	-	-	-	-	-	-	-	-	-	0.0	
17/Sep/2007	29/Sep/2007	6.0	25.6	3.7	73.9	54.4	10.2	6.9	53.1	13.7	25.3	19.1	1.1	14.1	32.2	
29/Sep/2007	11/Oct/2007	4.8	39.7	20.8	16.1	221.1	49.4	25.6	234.0	5.1	<1.0	13.1	16.2	44.8	10.9	
11/Oct/2007	26/Oct/2007	-	-	-	-	-	-	-	-	-	-	-	-	-	0.0	
26/Oct/2007	08/Nov/2007	4.7	32.3	15.6	4.7	146.9	29.0	26.6	141.2	2.7	<1.0	14.6	20.0	-	4.7	
08/Nov/2007	22/Nov/2007	5.7	140.2	26.9	104.5	365.3	28.1	126.1	401.5	19.0	86.1	96.2	1.9	73.7	75.8	
22/Nov/2007	06/Dec/2007	4.7	41.1	12.5	12.4	164.2	32.3	24.0	170.7	5.3	1.3	21.3	20.0	-	8.2	
06/Dec/2007	20/Dec/2007	-	-	-	-	-	-	-	-	-	-	-	-	-	0.0	
20/Dec/2007	10/Jan/2008	4.8	17.5	8.7	6.3	66.9	13.1	5.8	71.1	1.9	<1.0	9.4	16.6	16.1	90.1	
			Precipitation<weighted annual means for site(samples containing phosphate are excluded)													Total rainfall
5106			29.4	19.1	18.1	65.1	13.7	15.6	72.4	2.7	0.8	21.6	22.5	688.7		

# Loch Chon

2007

Site Code: 5156  
 Easting: 2429  
 Northing: 7084  
 Latitude: 56 14 52 N  
 Longitude: 04 32 09 W  
 Altitude (m): 150  
 Rainfall (mm): 1987  
 [30 year mean 1940 - 1971]

Site Environment:  
 Moorland overlooking Loch Katrine

Other measurements:  
 UKAWMN

Site Operator:  
 Fisheries Research Services

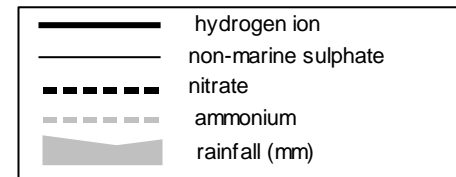

long-term trends in concentration (+x = increase; -x = decrease)	
<i>hydrogen ion</i>	-1.37 ueq/l (-3.50 %/year): 8 years' data - No significant trend detected
<i>non-marine sulphate</i>	-0.87 ueq/l (-3.03 %/year): 9 years' data + Significant trend detected
<i>nitrate</i>	-0.58 ueq/l (-2.40 %/year): 9 years' data + Significant trend detected
<i>ammonium</i>	0.10 ueq/l (0.90 %/year): 9 years' data - No significant trend detected

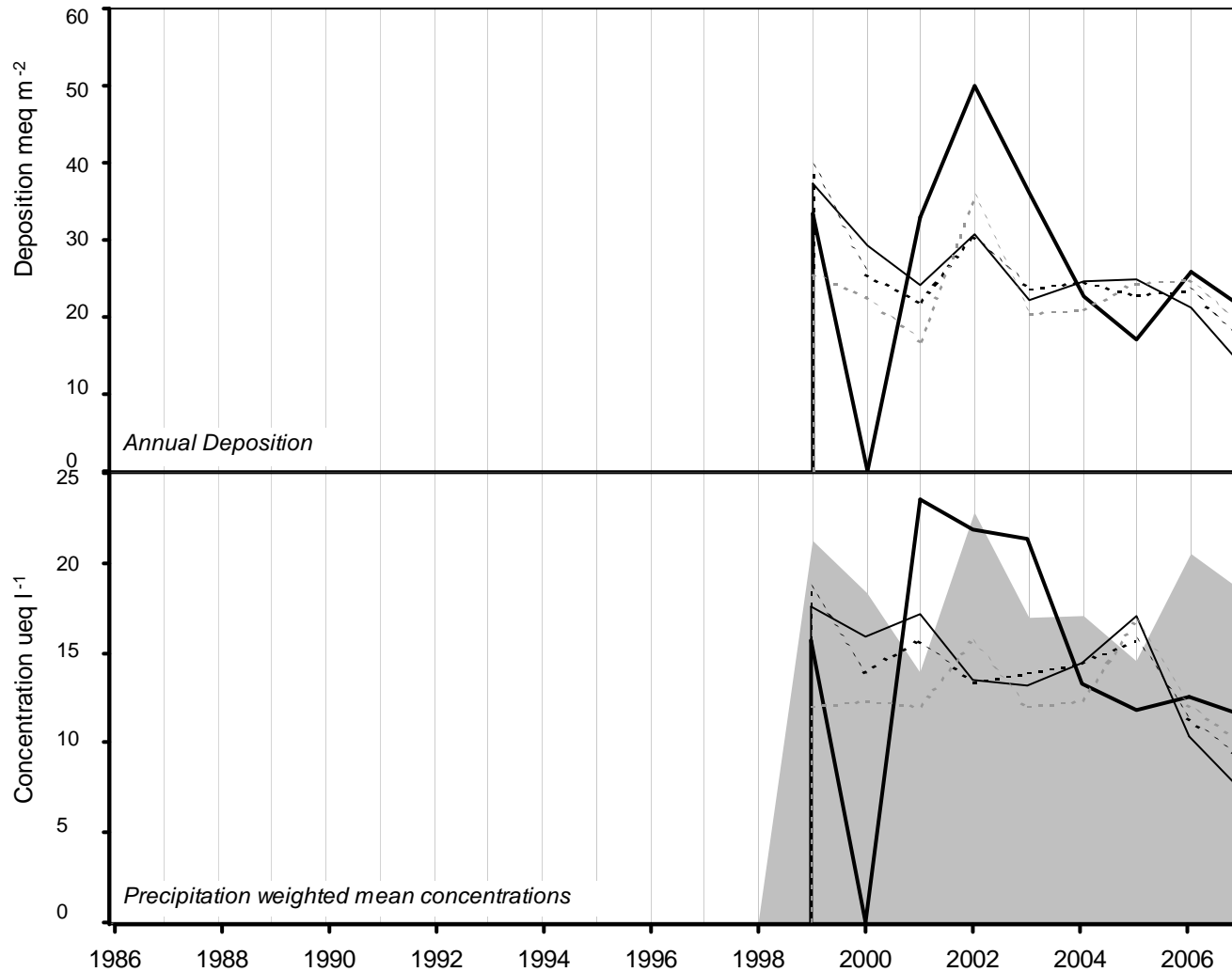

### (5156) Loch Chon

Start Date	End Date	pH	SO4 (µeq/l)	NO3 (µeq/l)	NH4 (µeq/l)	Na (µeq/l)	Mg (µeq/l)	Ca (µeq/l)	Cl (µeq/l)	K (µeq/l)	PO4 (µeq/l)	Nss SO4 (µeq/l)	H+ (µeq/l)	Conductivity (S/cm)	Rainfall (mm)	
10/Jan/2007	24/Jan/2007	5.3	48.0	4.9	12.4	447.5	89.9	17.9	462.9	6.0	<1.0	0.0	4.6	60.9	213.4	
24/Jan/2007	07/Feb/2007	4.7	8.6	2.7	<0.7	56.9	10.3	7.6	58.2	1.4	<1.0	1.7	20.0	-	1.7	
07/Feb/2007	21/Feb/2007	4.4	29.5	30.7	23.6	77.4	16.2	6.0	84.4	2.2	<1.0	20.2	37.2	25.7	27.0	
21/Feb/2007	07/Mar/2007	5.1	8.9	5.4	5.2	43.8	8.7	2.2	50.0	0.8	<1.0	3.6	7.2	9.2	254.0	
07/Mar/2007	21/Mar/2007	5.1	32.2	6.2	6.2	220.8	46.5	14.0	242.5	3.5	<1.0	5.6	8.9	35.4	90.8	
21/Mar/2007	04/Apr/2007	-	-	-	-	-	-	-	-	-	-	-	-	-	0.0	
04/Apr/2007	18/Apr/2007	6.7	34.8	21.5	20.0	256.7	28.0	37.0	238.6	74.8	<1.0	3.9	0.2	49.9	5.3	
18/Apr/2007	02/May/2007	5.2	15.6	15.8	25.2	13.7	3.3	6.9	15.4	1.0	<1.0	14.0	5.9	8.0	73.1	
02/May/2007	16/May/2007	5.0	21.9	8.4	14.0	111.4	24.0	11.1	101.9	2.9	<1.0	8.5	11.2	20.3	52.3	
16/May/2007	30/May/2007	5.5	19.7	2.3	3.8	140.9	26.9	7.4	151.8	3.1	<1.0	2.8	3.5	23.2	59.8	
30/May/2007	13/Jun/2007	6.2	34.7	32.0	111.2	9.0	0.9	1.9	10.9	6.9	18.4	33.6	0.6	18.1	73.4	
13/Jun/2007	11/Jul/2007	4.5	13.9	15.1	4.6	6.8	2.0	3.2	8.5	<0.5	<1.0	13.1	35.5	11.6	117.6	
11/Jul/2007	25/Jul/2007	4.7	11.8	5.3	1.2	4.1	1.1	3.1	4.9	0.6	<1.0	11.3	18.2	7.0	45.6	
25/Jul/2007	08/Aug/2007	5.6	15.6	7.8	13.8	31.5	4.4	7.2	27.7	1.4	<1.0	11.8	2.6	5.8	87.5	
08/Aug/2007	22/Aug/2007	4.7	7.6	6.0	0.7	14.1	3.9	5.8	14.6	<0.5	<1.0	5.9	19.5	4.9	61.6	
22/Aug/2007	05/Sep/2007	4.4	10.2	1.3	1.3	35.5	11.1	9.7	40.4	1.9	<1.0	6.0	39.8	-	10.6	
05/Sep/2007	26/Sep/2007	5.9	15.5	4.3	27.3	71.9	13.9	5.3	79.9	5.0	9.0	6.8	1.3	11.4	91.1	
26/Sep/2007	03/Oct/2007	5.0	43.6	74.9	48.2	60.1	16.5	16.9	56.0	3.8	<1.0	36.4	10.0	-	3.6	
03/Oct/2007	17/Oct/2007	6.4	28.8	25.9	83.9	44.0	6.9	3.1	50.1	9.4	18.8	23.5	0.4	16.0	58.4	
17/Oct/2007	31/Oct/2007	5.0	20.3	19.5	16.9	99.5	18.6	6.5	97.8	2.4	<1.0	8.3	11.0	17.8	50.3	
31/Oct/2007	15/Nov/2007	4.8	24.1	8.1	5.1	143.2	29.9	10.7	152.6	3.1	<1.0	6.8	15.8	24.3	42.1	
15/Nov/2007	28/Nov/2007	4.7	16.9	17.0	11.8	65.0	12.5	5.2	66.5	1.8	2.8	9.0	19.1	15.2	60.2	
28/Nov/2007	12/Dec/2007	5.2	16.0	5.2	3.0	109.7	21.0	6.4	118.1	2.2	<1.0	2.8	6.9	15.9	140.9	
12/Dec/2007	24/Dec/2007	4.9	31.6	25.5	20.8	179.1	36.4	10.9	185.8	4.3	2.1	10.0	13.8	32.8	53.3	
24/Dec/2007	09/Jan/2008	4.8	32.9	8.8	6.1	236.9	49.8	13.3	256.5	5.0	<1.0	4.4	15.8	39.3	160.6	
			Precipitation<weighted annual means for site(samples containing phosphate are excluded)													Total rainfall
5156			22.2	9.0	9.9	138.2	27.9	8.5	145.8	3.0	1.1	7.2	11.5		1834.3	

# Balquhidder

2007

Site Code: 5152  
 Easting: 2521  
 Northing: 7206  
 Latitude: 56 21 17 N  
 Longitude: 04 23 38 W  
 Altitude (m): 135  
 Rainfall (mm): 2011  
 [30 year mean 1940 - 1971]

Site Environment:  
 Open sheep pasture at loch-side

Other measurements:  
 DT, Met

Site Operator:  
 Mountain Environments

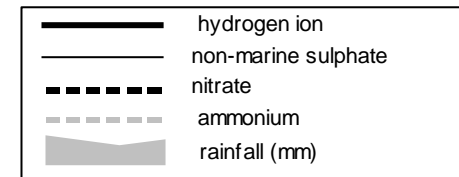
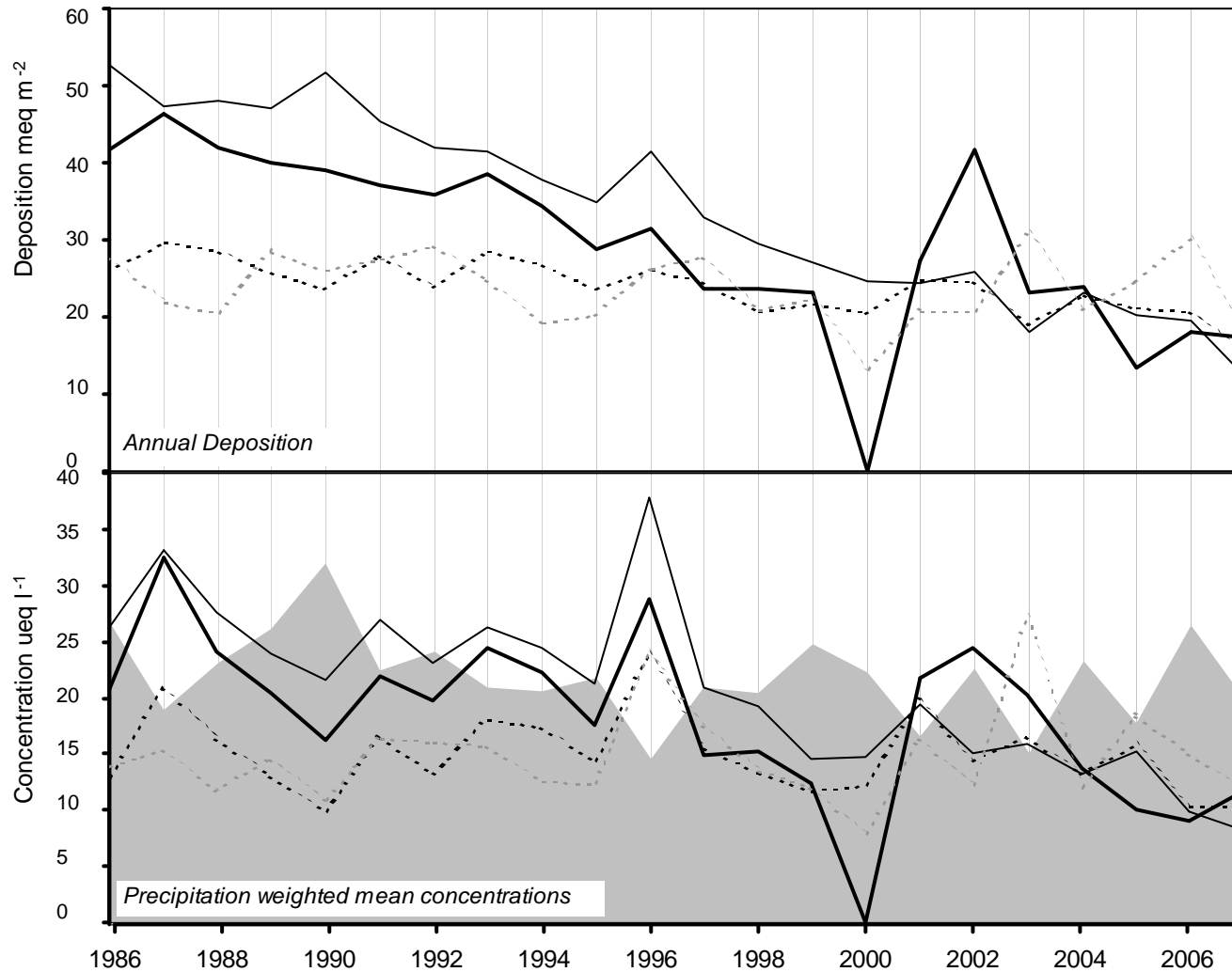

long-term trends in concentration (+x = increase; -x = decrease)	
<i>hydrogen ion</i>	-0.63 ueq/l (-2.50 %/year): 21 years' data ++ Moderately strong trend detected
<i>non-marine sulphate</i>	-0.89 ueq/l (-2.96 %/year): 22 years' data +++ Strong trend detected
<i>nitrate</i>	-0.12 ueq/l (-0.75 %/year): 22 years' data - No significant trend detected
<i>ammonium</i>	0.13 ueq/l (0.95 %/year): 22 years' data - No significant trend detected

## (5152) Balquhiddar

Start Date	End Date	pH	SO4 (µeq/l)	NO3 (µeq/l)	NH4 (µeq/l)	Na (µeq/l)	Mg (µeq/l)	Ca (µeq/l)	Cl (µeq/l)	K (µeq/l)	PO4 (µeq/l)	Nss SO4 (µeq/l)	H+ (µeq/l)	Conductivity (S/cm)	Rainfall (mm)
16/Jan/2007	27/Jan/2007	5.1	23.1	5.3	<0.7	184.0	36.6	10.7	185.1	2.6	<1.0	0.9	8.1	27.6	57.4
27/Jan/2007	12/Feb/2007	4.4	27.0	22.7	16.5	67.5	15.1	5.9	74.2	1.2	<1.0	18.9	42.7	23.6	39.3
12/Feb/2007	19/Feb/2007	4.8	34.5	24.3	23.7	120.3	24.2	14.4	144.1	2.6	<1.0	20.0	16.6	28.4	26.7
19/Feb/2007	05/Mar/2007	5.0	9.7	10.6	7.4	36.4	6.6	4.8	36.1	1.3	<1.0	5.3	9.3	9.0	152.1
05/Mar/2007	19/Mar/2007	5.3	22.0	4.6	7.0	145.9	27.6	6.2	162.6	2.2	<1.0	4.4	4.8	23.8	129.2
19/Mar/2007	30/Apr/2007	5.4	22.0	21.1	36.2	25.2	5.7	9.3	28.0	1.6	<1.0	18.9	4.5	10.9	50.4
30/Apr/2007	15/May/2007	4.9	23.7	10.6	20.4	103.7	20.8	11.0	93.8	3.0	<1.0	11.2	11.5	18.8	67.6
15/May/2007	29/May/2007	5.9	21.4	2.7	11.8	152.1	22.5	11.3	157.8	11.2	<1.0	3.1	1.2	24.7	39.5
29/May/2007	13/Jun/2007	4.9	19.0	19.6	24.8	6.2	1.5	5.3	6.7	1.3	<1.0	18.3	13.8	8.9	43.3
13/Jun/2007	26/Jun/2007	4.7	14.7	19.8	12.9	12.5	2.3	3.2	14.4	1.1	<1.0	13.2	21.4	12.1	55.7
26/Jun/2007	09/Jul/2007	4.7	13.0	11.2	1.2	4.8	2.4	2.4	8.2	1.2	<1.0	12.4	20.4	7.5	52.2
09/Jul/2007	24/Jul/2007	5.6	25.3	9.4	31.2	10.5	1.1	<1.0	6.3	11.2	17.5	24.0	2.6	8.7	58.1
24/Jul/2007	03/Aug/2007	7.0	32.5	9.2	338.9	36.1	3.5	1.2	41.5	29.9	51.0	28.1	0.1	47.5	29.0
03/Aug/2007	20/Aug/2007	5.7	14.7	8.5	35.4	17.5	2.5	3.1	16.6	2.3	<1.0	12.6	2.0	6.9	110.5
20/Aug/2007	04/Sep/2007	6.5	355.4	20.8	1875.1	101.6	14.6	17.2	96.8	425.5	1089.6	343.1	0.3	-	4.6
04/Sep/2007	17/Sep/2007	5.6	4.6	2.9	7.3	13.8	0.9	1.9	13.3	1.2	<1.0	3.0	2.3	3.4	15.4
17/Sep/2007	01/Oct/2007	5.0	27.9	5.0	146.8	101.1	16.6	7.5	111.1	15.6	49.1	15.8	10.0	-	6.0
01/Oct/2007	17/Oct/2007	6.7	35.0	31.4	163.5	27.6	4.8	2.8	30.9	15.9	31.8	31.6	0.2	23.3	54.8
17/Oct/2007	29/Oct/2007	6.5	218.9	16.0	4064.9	86.6	12.2	3.1	165.2	413.2	154.8	208.5	0.3	-	13.0
29/Oct/2007	12/Nov/2007	5.7	20.4	5.5	9.6	108.6	21.0	16.4	119.1	2.5	2.7	7.3	2.2	15.9	20.7
12/Nov/2007	26/Nov/2007	4.7	18.2	21.1	12.6	67.2	13.5	5.9	70.2	1.9	<1.0	10.1	21.4	17.3	47.8
26/Nov/2007	10/Dec/2007	4.9	14.2	4.6	<0.7	90.0	17.8	6.6	96.7	2.2	2.1	3.4	13.5	18.2	116.8
10/Dec/2007	24/Dec/2007	4.8	19.4	24.9	19.0	86.4	16.1	5.6	86.4	2.1	<1.0	9.0	16.2	19.9	25.7
24/Dec/2007	14/Jan/2008	4.9	19.4	7.1	5.5	115.3	23.5	7.3	124.3	2.6	<1.0	5.5	13.5	20.7	269.2
5152			18.1	10.4	11.9	81.6	15.9	6.7	86.6	2.3	0.7	8.3	11.7		Total rainfall 1485.0

# Polloch

2007

Site Code: 5151  
 Easting: 1792  
 Northing: 7689  
 Latitude: 56 45 34 N  
 Longitude: 05 36 46 W  
 Altitude (m): 30  
 Rainfall (mm): 1144

[30 year mean 1940 - 1971]

Site Environment:  
 Open moorland, in forest area

Other measurements:  
 DT, UKAWMN

Site Operator:  
 Mr. J Kirby

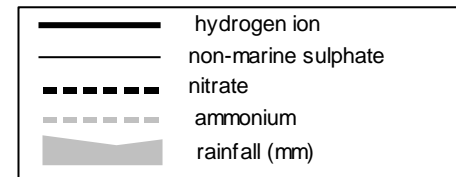

long-term trends in concentration (+x = increase; -x = decrease)	
<i>hydrogen ion</i>	-0.34 ueq/l (-2.14 %/year): 16 years' data + Significant trend detected
<i>non-marine sulphate</i>	-0.73 ueq/l (-3.57 %/year): 17 years' data ++++ Very strong trend detected
<i>nitrate</i>	-0.19 ueq/l (-1.86 %/year): 17 years' data + Significant trend detected
<i>ammonium</i>	-0.03 ueq/l (-0.41 %/year): 17 years' data - No significant trend detected

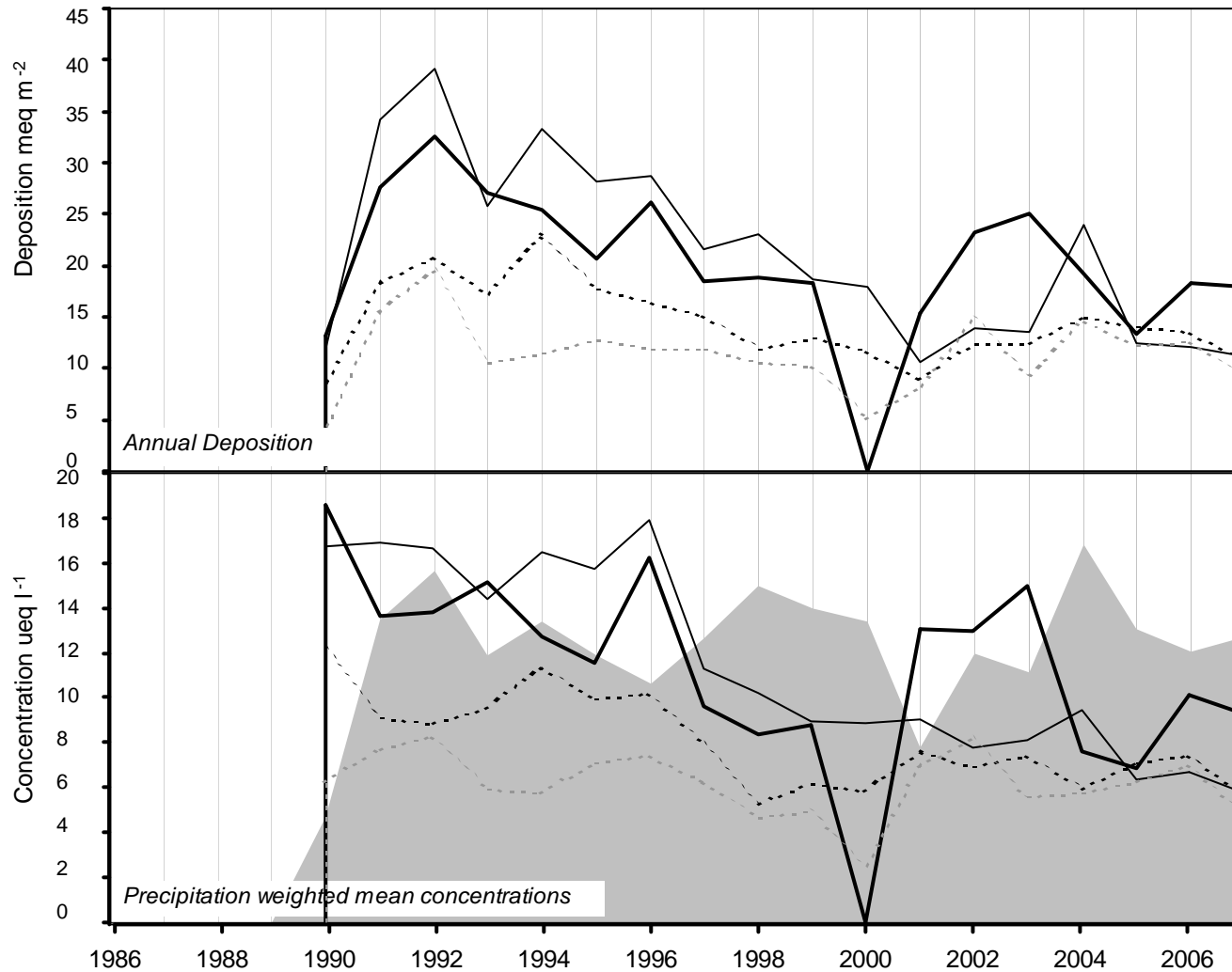

(5151) Polloch

Start Date	End Date	pH	SO4 (µeq/l)	NO3 (µeq/l)	NH4 (µeq/l)	Na (µeq/l)	Mg (µeq/l)	Ca (µeq/l)	Cl (µeq/l)	K (µeq/l)	PO4 (µeq/l)	Nss SO4 (µeq/l)	H+ (µeq/l)	Conductivity (S/cm)	Rainfall (mm)
09/Jan/2007	23/Jan/2007	5.5	79.5	5.8	9.6	773.5	151.2	30.6	805.4	10.4	<1.0	0.0	3.3	103.9	97.7
23/Jan/2007	06/Feb/2007	6.2	23.7	3.1	<0.7	103.9	16.5	12.2	196.1	1.6	<1.0	11.2	0.7	30.1	74.1
06/Feb/2007	20/Feb/2007	4.7	25.0	15.8	14.2	141.7	29.0	8.6	149.7	3.0	<1.0	7.9	19.5	27.2	61.9
20/Feb/2007	06/Mar/2007	5.3	16.8	5.0	3.2	143.2	28.5	7.5	153.2	2.0	<1.0	0.0	5.6	23.2	119.7
06/Mar/2007	20/Mar/2007	5.2	44.7	4.4	4.6	376.2	76.3	15.4	404.4	5.9	<1.0	0.0	6.9	56.3	115.7
20/Mar/2007	03/Apr/2007	5.1	4.6	3.9	1.0	14.0	3.7	3.7	16.1	0.7	<1.0	2.9	7.6	4.5	16.4
03/Apr/2007	17/Apr/2007	5.0	35.9	10.1	11.6	192.4	27.5	56.8	156.9	16.2	<1.0	12.8	10.0	-	1.9
17/Apr/2007	01/May/2007	4.8	18.7	15.1	20.9	21.6	4.9	8.4	24.5	1.7	<1.0	16.1	17.4	11.0	21.8
01/May/2007	15/May/2007	5.4	24.5	5.3	20.0	147.0	31.0	11.3	139.7	7.0	10.2	6.8	3.7	24.5	54.5
15/May/2007	29/May/2007	5.3	23.8	0.9	0.9	183.0	36.6	10.5	198.8	5.1	<1.0	1.8	5.5	27.3	56.7
29/May/2007	12/Jun/2007	4.8	11.2	5.9	<0.7	7.6	1.8	3.3	9.7	0.7	2.5	10.3	15.5	7.1	63.2
12/Jun/2007	26/Jun/2007	4.5	15.3	20.6	6.6	5.1	1.6	3.7	5.7	<0.5	<1.0	14.7	35.5	13.7	62.4
26/Jun/2007	10/Jul/2007	5.0	9.6	<0.7	0.1	20.3	4.1	2.0	25.2	0.3	<1.0	7.2	10.7	6.3	51.1
10/Jul/2007	24/Jul/2007	4.6	18.6	14.9	3.1	18.6	3.3	4.2	14.5	1.2	<1.0	16.4	27.5	11.9	11.3
24/Jul/2007	07/Aug/2007	4.9	11.3	4.1	5.9	39.9	7.4	6.9	45.3	1.5	<1.0	6.5	13.8	7.5	105.6
07/Aug/2007	21/Aug/2007	4.9	11.0	2.5	2.9	65.3	12.0	8.5	72.0	1.7	<1.0	3.1	12.3	9.7	81.6
21/Aug/2007	04/Sep/2007	5.1	10.4	2.2	2.3	46.1	8.8	7.5	55.1	1.6	<1.0	4.8	8.7	7.7	73.9
04/Sep/2007	17/Sep/2007	4.9	13.8	5.6	3.9	49.1	11.2	4.8	52.5	1.5	<1.0	7.9	11.5	8.4	128.4
17/Sep/2007	02/Oct/2007	6.1	28.3	4.5	<0.7	203.7	40.3	16.3	221.9	8.7	1.5	3.8	0.7	31.8	20.2
02/Oct/2007	18/Oct/2007	5.0	18.9	14.4	17.4	74.7	16.6	7.3	80.8	2.2	1.6	9.9	11.2	13.0	48.9
18/Oct/2007	30/Oct/2007	5.7	16.2	10.1	9.1	84.5	14.5	11.1	82.6	3.0	2.7	6.0	2.1	12.8	68.2
30/Oct/2007	13/Nov/2007	5.2	25.8	2.9	3.2	198.6	40.3	11.5	216.9	4.5	<1.0	1.9	7.1	27.4	154.5
13/Nov/2007	27/Nov/2007	5.3	29.9	5.1	4.6	231.6	46.8	17.9	247.0	4.6	<1.0	2.0	5.5	32.2	61.4
27/Nov/2007	11/Dec/2007	5.3	29.1	1.9	1.6	242.1	50.9	14.4	258.9	4.6	2.0	0.0	4.6	32.7	153.6
11/Dec/2007	24/Dec/2007	5.0	28.3	22.0	19.8	152.6	31.0	10.7	154.0	3.7	1.2	9.9	10.5	27.9	17.2
24/Dec/2007	15/Jan/2008	5.0	33.1	4.8	3.4	269.0	55.8	12.8	291.6	5.2	<1.0	0.7	9.3	41.7	193.0
5151		Precipitation<weighted annual means for site(samples containing phosphate are excluded)													
		25.2	5.7	4.7	180.4	36.3	11.0	196.3	3.5	0.8	5.8	9.3	Total rainfall		1915.0

# Lochnagar

2007

Site Code: 5157  
 Easting: 3252  
 Northing: 7859  
 Latitude: 56 57 29N  
 Longitude: 03 13 51 W  
 Altitude (m): 785  
 Rainfall (mm): 1266  
 [30 year mean 1940 - 1971]

Site Environment:  
 Heathland 60% and bare ground 40%

Other measurements:  
 UKAWMN, Automatic weather station

Site Operator:  
 ENSIS

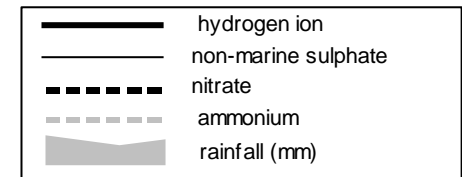
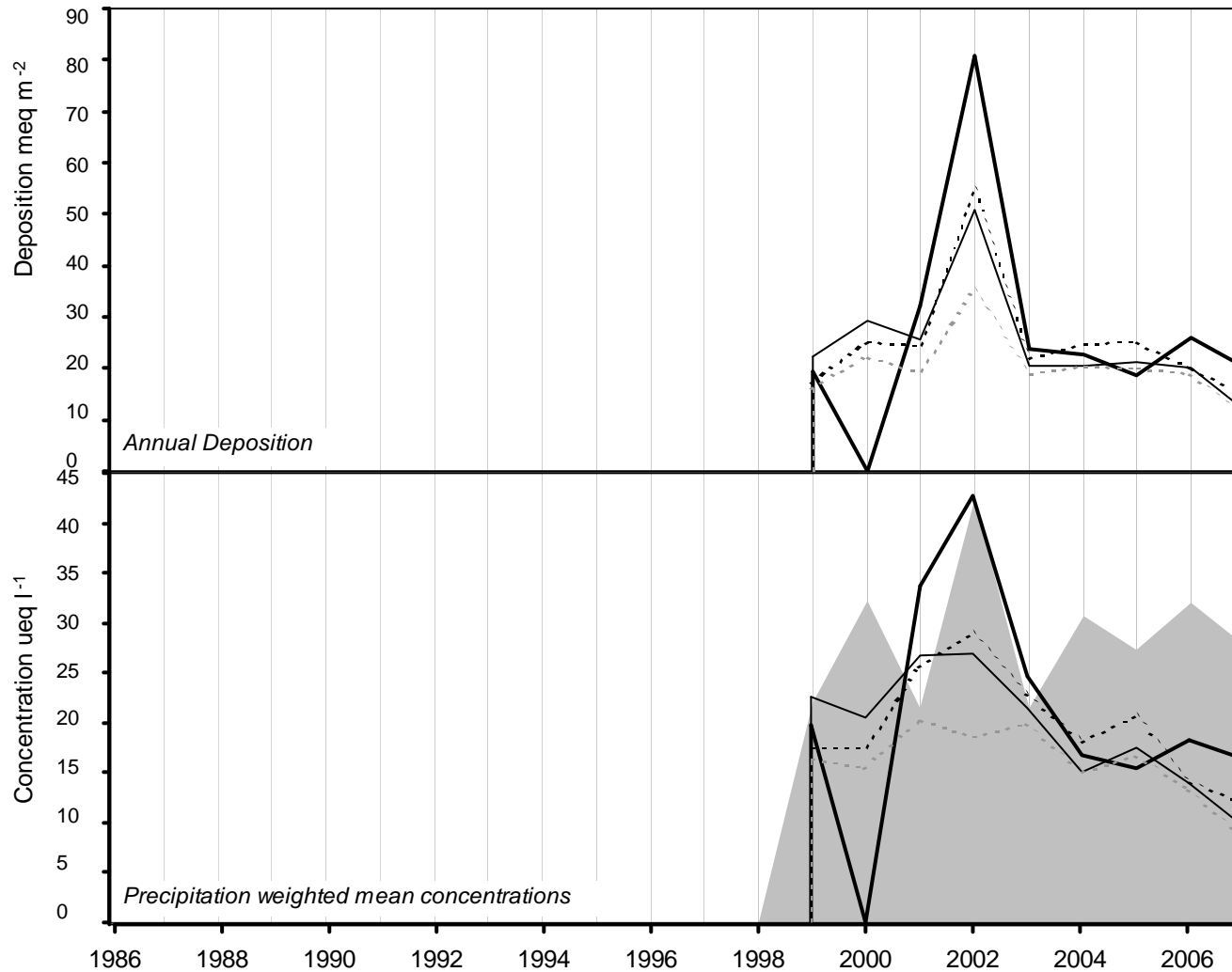

long-term trends in concentration (+x = increase; -x = decrease)	
<i>hydrogen ion</i>	-2.13 ueq/l (-3.62 %/year): 8 years' data - No significant trend detected
<i>non-marine sulphate</i>	-1.68 ueq/l (-3.49 %/year): 9 years' data ++ Moderately strong trend detected
<i>nitrate</i>	-0.74 ueq/l (-2.27 %/year): 9 years' data - No significant trend detected
<i>ammonium</i>	-0.51 ueq/l (-2.02 %/year): 9 years' data - No significant trend detected



(5157) Lochnagar

Start Date	End Date	pH	SO4 (µeq/l)	NO3 (µeq/l)	NH4 (µeq/l)	Na (µeq/l)	Mg (µeq/l)	Ca (µeq/l)	Cl (µeq/l)	K (µeq/l)	PO4 (µeq/l)	Nss SO4 (µeq/l)	H+ (µeq/l)	Conductivity (S/cm)	Rainfall (mm)	
25/Jan/2007	21/Feb/2007	4.6	29.9	21.0	27.0	86.9	17.5	7.0	87.6	2.3	<1.0	19.4	22.9	23.0	19.9	
21/Feb/2007	08/Mar/2007	4.9	12.7	11.4	6.6	31.5	6.2	2.1	36.1	0.6	<1.0	8.9	12.3	10.0	93.3	
08/Mar/2007	23/Mar/2007	5.4	14.8	7.9	9.0	65.9	12.6	4.9	71.3	1.3	<1.0	6.9	3.9	13.0	15.5	
23/Mar/2007	04/Apr/2007	4.6	71.5	108.5	109.3	62.0	18.4	42.4	56.4	5.4	<1.0	64.1	24.5	35.2	5.9	
04/Apr/2007	18/Apr/2007	4.4	28.0	57.3	20.7	85.1	24.6	64.6	71.5	4.8	<1.0	17.7	39.8	-	2.6	
18/Apr/2007	02/May/2007	4.7	24.1	17.4	24.0	11.2	4.1	7.8	15.6	1.2	<1.0	22.8	19.1	11.7	42.5	
02/May/2007	17/May/2007	4.8	12.1	9.6	10.7	24.9	5.6	8.2	19.9	0.6	<1.0	9.1	15.8	10.3	66.6	
17/May/2007	31/May/2007	5.3	7.8	4.1	2.4	38.9	6.0	3.4	39.3	1.1	<1.0	3.1	5.0	8.2	75.3	
31/May/2007	13/Jun/2007	4.8	27.3	30.6	32.2	7.8	2.0	6.5	4.3	1.3	<1.0	26.3	16.2	17.0	24.5	
13/Jun/2007	28/Jun/2007	4.7	14.1	12.9	7.5	15.8	3.7	2.8	20.4	0.4	<1.0	12.2	21.4	10.1	107.0	
28/Jun/2007	11/Jul/2007	4.7	9.2	8.7	2.1	1.1	1.5	1.4	3.1	<0.5	<1.0	9.0	19.1	5.9	76.2	
11/Jul/2007	08/Aug/2007	4.7	8.5	6.0	5.4	6.0	2.0	8.5	5.7	<0.5	<1.0	7.8	20.4	4.6	205.9	
08/Aug/2007	22/Aug/2007	4.8	7.3	8.6	1.6	9.1	2.5	6.3	9.0	0.6	<1.0	6.2	16.2	3.3	80.2	
22/Aug/2007	05/Sep/2007	4.7	11.9	3.8	<0.7	39.2	11.1	8.6	44.6	2.0	4.5	7.1	20.0	-	7.9	
05/Sep/2007	19/Sep/2007	5.3	5.8	2.4	1.7	33.7	8.1	4.1	36.0	1.0	<1.0	1.8	5.4	4.8	26.7	
19/Sep/2007	02/Oct/2007	5.3	22.1	10.4	14.2	108.1	20.9	14.4	128.2	2.3	<1.0	9.0	4.6	19.4	25.5	
02/Oct/2007	18/Oct/2007	4.7	41.6	60.1	51.7	57.0	15.2	15.1	52.3	2.5	1.6	34.8	20.0	-	6.3	
18/Oct/2007	15/Nov/2007	5.1	14.5	20.2	12.4	61.9	11.6	6.9	57.1	2.1	<1.0	7.0	8.7	10.5	42.9	
15/Nov/2007	28/Nov/2007	4.6	16.7	24.4	14.3	42.7	8.9	4.5	44.6	1.2	<1.0	11.6	25.1	15.0	109.5	
28/Nov/2007	13/Dec/2007	4.8	12.2	10.7	3.7	42.1	8.6	6.2	45.8	1.6	<1.0	7.1	17.0	12.9	78.1	
13/Dec/2007	31/Dec/2007	5.3	14.0	14.6	5.8	86.6	16.7	5.9	83.3	1.9	2.2	3.6	5.6	15.3	12.7	
31/Dec/2007	25/Jan/2008	4.9	11.6	6.7	4.4	32.0	8.9	8.9	35.6	1.2	2.7	7.8	12.3	9.1	110.3	
			Precipitation<weighted annual means for site(samples containing phosphate are excluded)													Total rainfall
5157			13.0	12.0	8.6	28.2	6.3	6.3	29.9	0.9	0.7	9.6	16.4	1235.3		

# Glensaugh

2007

Site Code: 5164  
 Easting: 3602  
 Northing: 7967  
 Latitude: 56 54 25 N  
 Longitude: 02 33 33 W  
 Altitude (m): 242  
 Rainfall (mm): 816

[30 year mean 1940 - 1971]

Site Environment:  
**Moorland**

Other measurements:  
 DT, ECN, HNO3 Denuder

Site Operator:  
**Macaulay Land Use Research Institute**

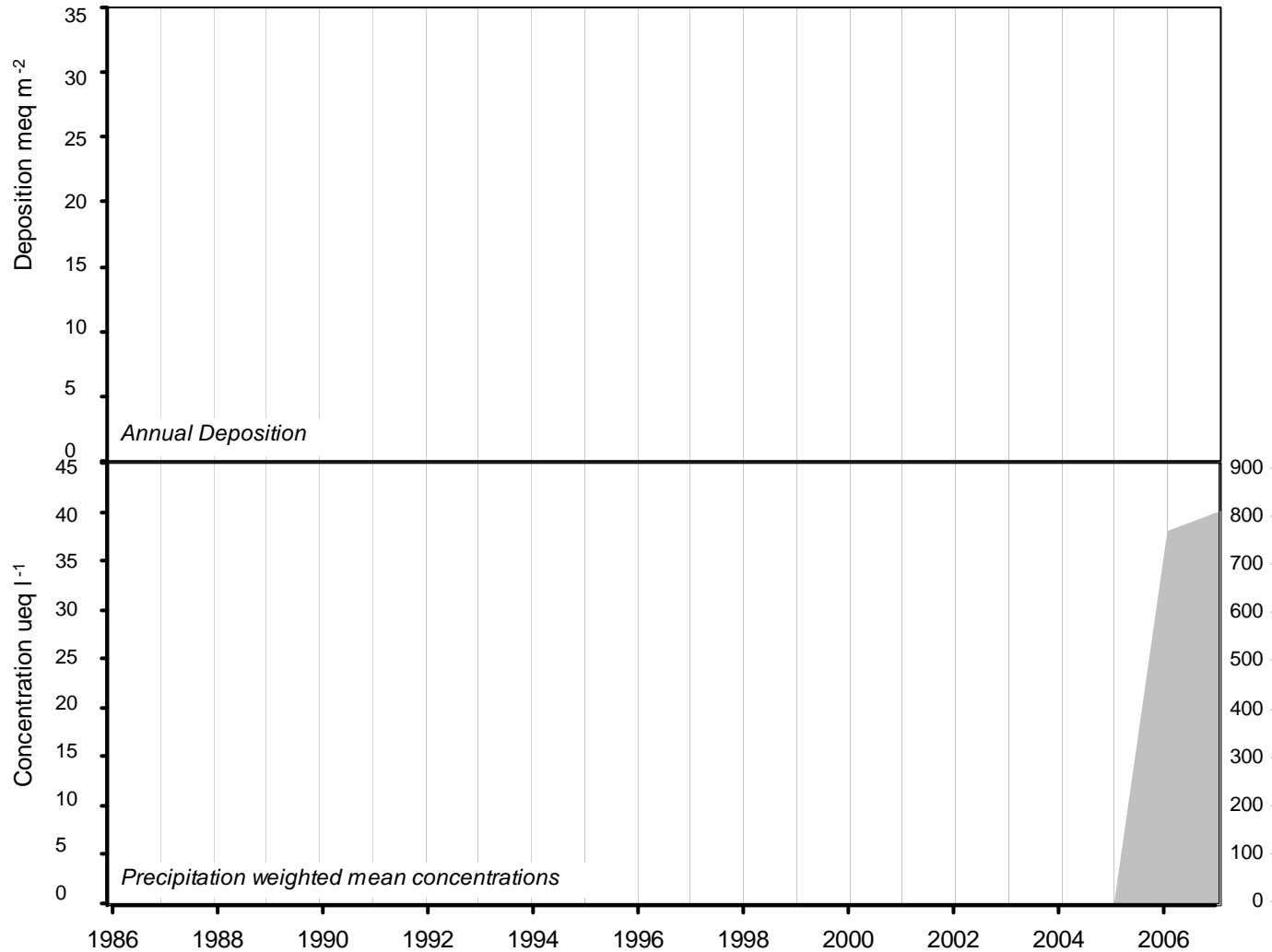
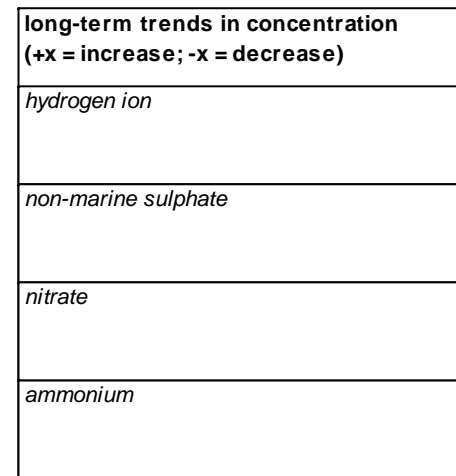
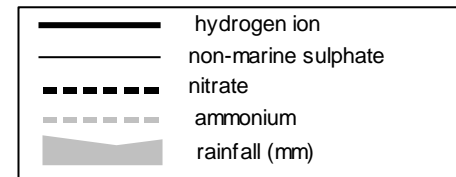

## (5164) Glensaugh

Start Date	End Date	pH	SO4 (µeq/l)	NO3 (µeq/l)	NH4 (µeq/l)	Na (µeq/l)	Mg (µeq/l)	Ca (µeq/l)	Cl (µeq/l)	K (µeq/l)	PO4 (µeq/l)	Nss SO4 (µeq/l)	H+ (µeq/l)	Conductivity (S/cm)	Rainfall (mm)
24/Jan/2007	07/Feb/2007	5.1	32.9	4.6	24.7	523.6	110.6	33.3	275.7	13.7	<1.0	0.0	8.7	82.1	3.9
07/Feb/2007	21/Feb/2007	4.4	50.3	36.9	42.5	203.9	44.5	10.9	217.0	5.6	<1.0	25.8	41.7	48.5	87.4
21/Feb/2007	07/Mar/2007	4.6	25.4	31.6	<0.7	6.1	1.3	<1.0	92.1	<0.5	<1.0	24.7	25.7	25.6	89.7
07/Mar/2007	20/Mar/2007	5.5	46.6	11.9	13.5	327.7	67.6	19.3	354.1	6.7	<1.0	7.1	3.2	50.9	10.4
20/Mar/2007	04/Apr/2007	4.6	86.6	107.3	90.8	280.3	68.9	70.9	263.9	10.8	4.7	52.8	24.5	68.6	3.0
04/Apr/2007	31/May/2007	5.1	10.0	7.4	4.0	35.0	6.1	4.8	35.4	1.4	<1.0	5.8	7.8	9.2	32.9
31/May/2007	13/Jun/2007	4.6	41.2	45.0	55.1	10.3	3.7	14.0	9.7	2.1	<1.0	39.9	22.9	18.0	16.6
13/Jun/2007	27/Jun/2007	-	-	-	-	-	-	-	-	-	-	-	-	-	0.0
27/Jun/2007	11/Jul/2007	6.3	29.4	11.7	110.4	5.3	1.5	<1.0	12.6	16.6	10.9	28.8	0.5	15.4	89.1
11/Jul/2007	25/Jul/2007	5.0	10.7	9.1	9.9	10.2	3.3	2.9	8.2	0.9	<1.0	9.5	9.8	5.4	94.5
25/Jul/2007	08/Aug/2007	5.2	13.1	10.2	18.0	9.9	1.7	2.8	8.4	0.9	<1.0	11.9	6.6	4.4	37.5
08/Aug/2007	22/Aug/2007	6.7	31.5	14.7	250.3	12.2	1.8	2.0	17.8	22.0	59.4	30.0	0.2	34.5	41.5
22/Aug/2007	05/Sep/2007	5.6	154.6	25.3	773.9	93.9	28.7	13.7	110.1	128.4	376.8	143.3	2.5	-	4.7
05/Sep/2007	19/Sep/2007	-	-	-	-	-	-	-	-	-	-	-	-	-	0.0
19/Sep/2007	03/Oct/2007	6.7	35.9	10.3	113.1	119.8	19.5	7.9	143.0	18.7	<1.0	21.5	0.2	33.1	12.9
03/Oct/2007	31/Oct/2007	4.7	53.0	52.2	70.7	44.7	9.7	15.0	36.4	2.5	2.8	47.6	20.9	21.4	27.6
31/Oct/2007	14/Nov/2007	5.3	20.6	3.9	143.3	103.9	5.9	3.3	112.7	13.7	25.4	8.0	5.0	-	6.8
14/Nov/2007	28/Nov/2007	4.5	33.0	37.8	22.7	132.4	27.0	9.2	140.3	2.7	2.8	17.1	35.5	32.3	74.4
28/Nov/2007	12/Dec/2007	4.7	19.1	12.4	7.3	73.8	15.1	8.4	80.2	2.0	2.1	10.2	20.9	19.0	67.5
12/Dec/2007	09/Jan/2008	4.4	40.3	30.4	24.1	143.9	30.6	9.9	152.6	4.4	2.1	23.0	39.8	35.6	103.6
Precipitation<weighted annual means for site(samples containing phosphate are excluded)															Total rainfall
5164			30.1	25.9	22.7	90.4	19.2	7.7	105.3	3.0	1.3	19.5	25.2	804.1	

# Allt a' Mharcaidh

2007

Site Code: 5103  
 Easting: 2876  
 Northing: 8052  
 Latitude: 57 07 27 N  
 Longitude: 03 51 24 W  
 Altitude (m): 274  
 Rainfall (mm): 2170  
 [30 year mean 1940 - 1971]

Site Environment:  
 Moorland, in forestry SW Cairngorms

Other measurements:  
 DT, UKAWMN

Site Operator:  
 Fisheries Research Services

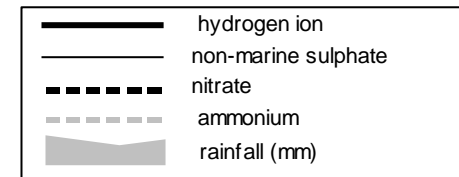

long-term trends in concentration (+x = increase; -x = decrease)	
<i>hydrogen ion</i>	-0.49 ueq/l (-2.33 %/year): 21 years' data +++ Strong trend detected
<i>non-marine sulphate</i>	-0.68 ueq/l (-3.16 %/year): 22 years' data ++++ Very strong trend detected
<i>nitrate</i>	-0.05 ueq/l (-0.43 %/year): 22 years' data - No significant trend detected
<i>ammonium</i>	0.02 ueq/l (0.32 %/year): 22 years' data - No significant trend detected

(5103) Allt a' Mharcaidh

Start Date	End Date	pH	SO4 (µeq/l)	NO3 (µeq/l)	NH4 (µeq/l)	Na (µeq/l)	Mg (µeq/l)	Ca (µeq/l)	Cl (µeq/l)	K (µeq/l)	PO4 (µeq/l)	Nss SO4 (µeq/l)	H+ (µeq/l)	Conductivity (S/cm)	Rainfall (mm)
08/Jan/2007	22/Jan/2007	5.2	31.2	3.6	<0.7	285.9	57.9	14.5	303.8	3.6	<1.0	0.0	5.8	41.2	65.7
22/Jan/2007	05/Feb/2007	4.7	27.1	2.7	<0.7	192.2	32.1	19.0	220.7	3.2	<1.0	4.0	20.0	-	3.7
05/Feb/2007	19/Feb/2007	4.6	32.1	26.6	17.5	117.3	26.6	11.0	125.1	2.5	<1.0	18.0	27.5	27.6	10.8
19/Feb/2007	05/Mar/2007	5.6	16.0	10.6	27.1	21.3	2.7	2.1	26.0	2.2	2.9	13.5	2.3	7.4	52.0
05/Mar/2007	19/Mar/2007	5.3	24.5	3.5	<0.7	183.8	37.5	10.5	198.9	3.2	<1.0	2.3	4.9	28.6	12.6
19/Mar/2007	02/Apr/2007	4.7	63.6	77.7	82.9	174.9	40.4	22.2	186.5	5.8	<1.0	42.6	20.0	-	12.8
02/Apr/2007	16/Apr/2007	-	-	-	-	-	-	-	-	-	-	-	-	-	0.0
16/Apr/2007	30/Apr/2007	4.7	19.0	11.5	13.0	49.6	6.9	6.6	39.7	2.0	2.2	13.0	20.0	-	6.0
30/Apr/2007	14/May/2007	7.0	91.4	6.5	656.3	65.2	8.6	7.2	78.8	83.6	205.9	83.6	0.1	109.9	35.6
14/May/2007	28/May/2007	6.8	57.4	3.9	197.0	102.8	9.6	2.7	105.5	31.7	118.6	45.0	0.2	44.3	17.9
28/May/2007	11/Jun/2007	6.8	75.4	11.3	314.4	24.2	5.8	5.2	17.7	41.6	202.3	72.4	0.2	51.3	54.5
11/Jun/2007	25/Jun/2007	7.4	136.0	14.4	1519.7	52.0	14.9	3.6	39.9	85.8	282.8	129.7	0.0	193.3	57.8
25/Jun/2007	09/Jul/2007	6.9	63.4	7.8	392.8	21.6	2.6	0.0	20.7	32.5	131.5	60.8	0.1	57.9	72.7
09/Jul/2007	23/Jul/2007	4.7	6.7	5.8	<0.7	5.4	1.3	3.1	5.7	0.6	<1.0	6.1	19.5	7.1	49.9
23/Jul/2007	06/Aug/2007	5.1	6.6	3.6	2.6	17.9	1.9	3.0	13.2	1.0	<1.0	4.5	8.5	3.7	42.2
06/Aug/2007	20/Aug/2007	-	-	-	-	-	-	-	-	-	-	-	-	-	0.0
20/Aug/2007	03/Sep/2007	5.1	18.8	9.5	2.2	52.1	9.4	7.7	51.1	2.7	<1.0	12.5	8.3	9.3	11.9
03/Sep/2007	17/Sep/2007	5.2	6.7	3.5	3.3	21.7	5.0	3.3	22.7	0.9	<1.0	4.1	6.5	4.6	22.3
17/Sep/2007	01/Oct/2007	6.3	40.1	4.7	62.2	106.5	16.4	9.6	126.0	16.8	42.9	27.3	0.5	24.6	16.8
01/Oct/2007	15/Oct/2007	4.7	19.7	27.9	12.6	11.4	4.6	10.8	8.9	1.1	1.5	18.4	20.0	-	7.2
15/Oct/2007	29/Oct/2007	5.3	3.3	6.0	<0.7	18.0	3.5	2.5	12.7	1.0	1.5	1.1	5.5	3.4	45.9
29/Oct/2007	12/Nov/2007	4.7	34.5	2.8	5.9	241.8	49.2	14.3	257.1	4.7	2.9	5.4	20.0	-	18.9
12/Nov/2007	26/Nov/2007	4.8	8.9	10.4	5.4	32.5	7.2	3.7	33.6	1.0	<1.0	5.0	14.8	8.2	58.4
26/Nov/2007	10/Dec/2007	5.1	7.9	0.3	<0.7	45.1	8.0	3.7	48.6	1.4	<1.0	2.4	7.4	8.8	68.2
10/Dec/2007	24/Dec/2007	4.7	20.5	55.8	11.3	140.4	23.6	18.8	104.7	3.1	2.1	3.6	20.0	-	3.8
24/Dec/2007	07/Jan/2008	4.8	12.3	9.3	3.3	54.2	10.9	4.0	57.4	1.6	<1.0	5.8	16.6	12.8	37.4
			Precipitation<weighted annual means for site(samples containing phosphate are excluded)												
5103			15.3	8.6	7.0	79.0	15.7	6.3	82.9	1.9	0.9	7.0	10.8		Total rainfall 784.9

# Strathvaich Dam

2007

Site Code: 5010  
 Easting: 2347  
 Northing: 8750  
 Latitude: 57 44 04 N  
 Longitude: 04 46 36 W  
 Altitude (m): 270  
 Rainfall (mm): 2055  
 [30 year mean 1940 - 1971]

Site Environment:  
 Open moorland, deer

Other measurements:  
 DT, HNO3 Denuder, NOx, ozone, EMEP

Site Operator:  
 CLOVA Environmental Research and Testing Services

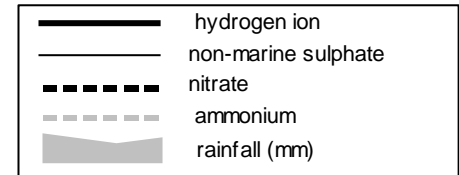
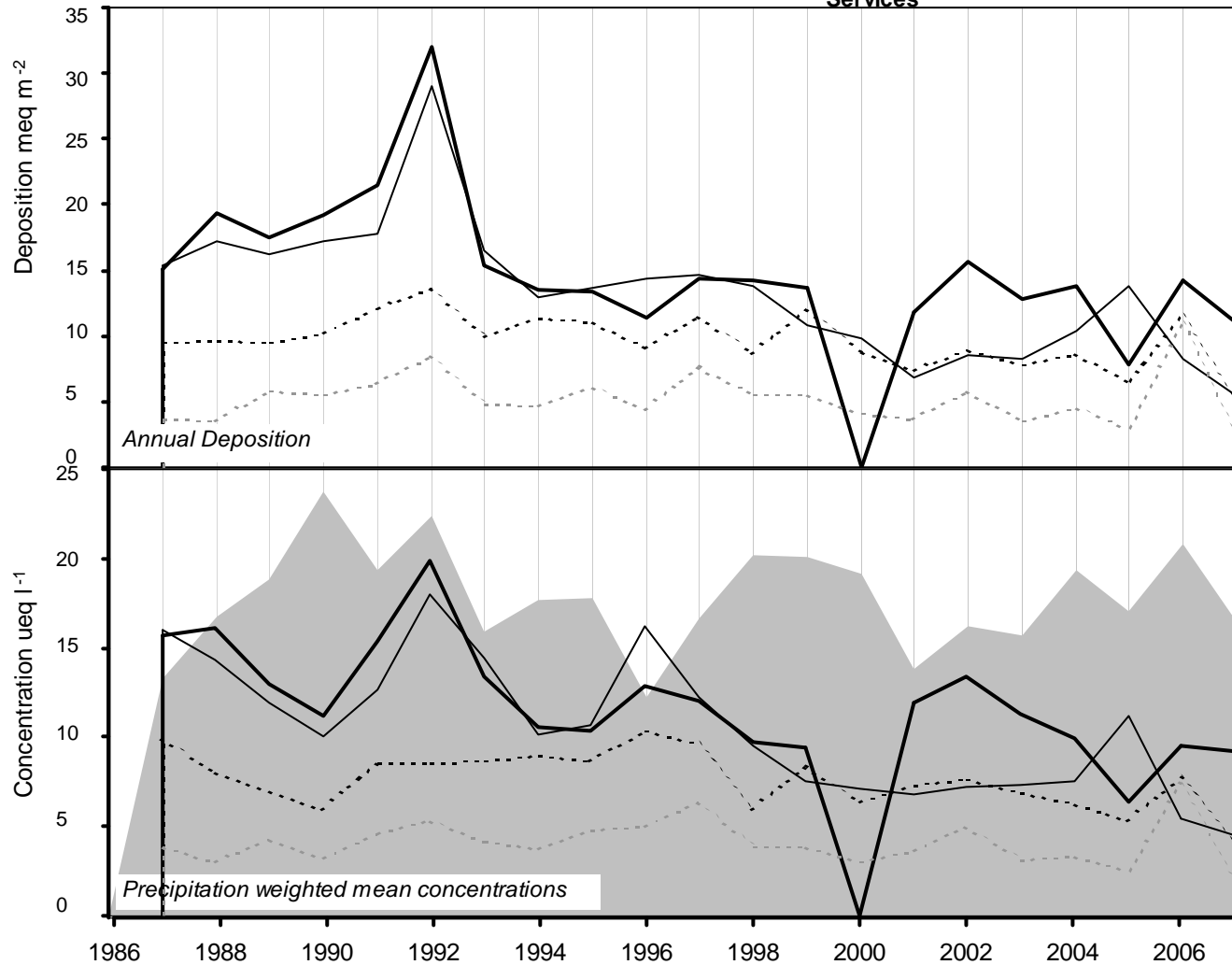

long-term trends in concentration (+x = increase; -x = decrease)	
<i>hydrogen ion</i>	-0.35 ueq/l (-2.21 %/year): 20 years' data ++ Moderately strong trend detected
<i>non-marine sulphate</i>	-0.44 ueq/l (-2.91 %/year): 21 years' data +++ Strong trend detected
<i>nitrate</i>	-0.09 ueq/l (-1.06 %/year): 21 years' data - No significant trend detected
<i>ammonium</i>	0.06 ueq/l (1.51 %/year): 21 years' data - No significant trend detected

(5010) Strathvaich Dam

Start Date	End Date	pH	SO4 (µeq/l)	NO3 (µeq/l)	NH4 (µeq/l)	Na (µeq/l)	Mg (µeq/l)	Ca (µeq/l)	Cl (µeq/l)	K (µeq/l)	PO4 (µeq/l)	Nss SO4 (µeq/l)	H+ (µeq/l)	Conductivity (S/cm)	Rainfall (mm)	
14/Jan/2007	29/Jan/2007	5.5	16.7	2.2	<0.7	152.7	27.3	6.7	155.4	3.9	<1.0	0.0	3.5	22.5	107.8	
29/Jan/2007	11/Feb/2007	5.0	11.1	2.8	2.3	81.8	14.0	4.1	87.9	1.3	<1.0	1.2	10.5	16.6	45.4	
11/Feb/2007	27/Feb/2007	4.7	8.5	13.2	4.4	48.6	9.7	4.8	52.2	1.1	<1.0	2.7	19.1	13.8	23.6	
27/Feb/2007	13/Mar/2007	5.2	14.3	2.7	1.3	9.0	1.4	<1.0	122.1	0.7	<1.0	13.2	6.0	17.9	72.7	
13/Mar/2007	26/Mar/2007	5.2	53.8	3.3	5.7	452.4	97.8	20.1	490.0	8.7	<1.0	0.0	7.1	66.5	51.8	
26/Mar/2007	11/Apr/2007	4.7	56.4	48.6	38.9	150.3	37.1	28.4	129.6	4.7	<1.0	38.3	20.0	-	1.8	
11/Apr/2007	29/Apr/2007	5.4	22.5	10.2	23.2	61.3	10.1	6.8	62.2	5.2	13.1	15.1	4.5	13.6	35.9	
29/Apr/2007	13/May/2007	5.0	16.6	5.8	4.3	84.5	16.1	11.1	91.5	2.1	<1.0	6.5	9.8	16.7	51.5	
13/May/2007	03/Jun/2007	5.3	7.5	1.8	<0.7	43.0	7.7	4.1	46.2	1.1	<1.0	2.3	5.2	8.2	97.6	
03/Jun/2007	20/Jun/2007	4.7	44.9	46.9	45.5	100.0	21.7	16.2	101.4	5.2	4.5	32.8	20.0	-	5.3	
20/Jun/2007	30/Jun/2007	6.5	32.7	18.4	144.0	27.6	2.3	<1.0	37.7	18.2	52.9	29.3	0.3	26.0	22.4	
30/Jun/2007	14/Jul/2007	4.8	6.5	5.8	<0.7	7.3	1.0	2.2	4.8	0.5	<1.0	5.6	15.1	5.6	78.0	
14/Jul/2007	01/Aug/2007	4.9	8.8	6.3	<0.7	35.0	4.9	3.7	32.8	1.0	<1.0	4.6	13.8	9.0	43.6	
01/Aug/2007	11/Aug/2007	4.8	9.1	4.2	1.2	37.2	7.6	5.4	44.6	0.8	<1.0	4.6	16.6	6.6	47.1	
11/Aug/2007	26/Aug/2007	4.9	9.6	1.6	<0.7	59.7	12.8	5.1	69.0	1.4	<1.0	2.4	14.1	7.8	49.7	
26/Aug/2007	12/Sep/2007	5.1	12.3	4.4	3.4	49.8	11.2	3.8	53.1	1.6	<1.0	6.3	8.3	8.0	49.2	
12/Sep/2007	30/Sep/2007	5.3	17.4	0.9	0.7	122.0	25.4	10.3	146.6	2.8	10.6	2.7	5.6	18.8	59.3	
30/Sep/2007	19/Oct/2007	5.1	15.1	9.5	2.5	82.8	16.3	9.6	83.8	2.3	<1.0	5.1	8.5	12.7	26.1	
19/Oct/2007	07/Nov/2007	5.0	18.2	2.8	1.6	141.3	27.4	8.4	147.4	3.2	<1.0	1.2	9.3	21.2	57.5	
07/Nov/2007	24/Nov/2007	5.0	31.3	5.2	2.4	247.0	51.1	14.5	263.6	4.7	<1.0	1.6	11.0	36.8	121.3	
24/Nov/2007	15/Dec/2007	5.3	25.3	1.9	1.2	224.6	46.5	11.8	235.3	4.5	1.3	0.0	5.5	32.4	120.2	
15/Dec/2007	03/Jan/2008	5.0	12.2	3.4	<0.7	93.5	17.4	6.4	98.9	2.2	2.3	0.9	9.3	16.7	17.8	
			Precipitation-weighted annual means for site(samples containing phosphate are excluded)													Total rainfall
5010			17.9	4.1	1.9	124.5	25.0	7.7	139.4	2.8	0.6	4.5	9.2		1185.6	

# Forsinain2

2007

Site Code: 5166  
 Easting: 2906  
 Northing: 9486  
 Latitude: 58 24 50 N  
 Longitude: 03 52 10 W  
 Altitude (m): 70  
 Rainfall (mm): 993

[30 year mean 1940 - 1971]

Site Environment:  
0

Other measurements:  
DT, HNO3 Denuder

Site Operator:  
Fountain Forestry Ltd

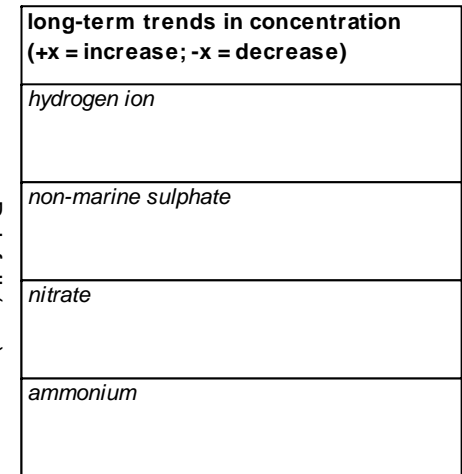
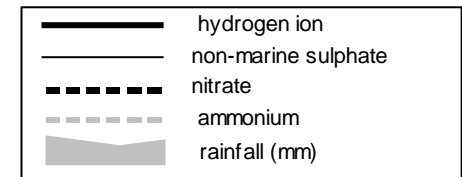
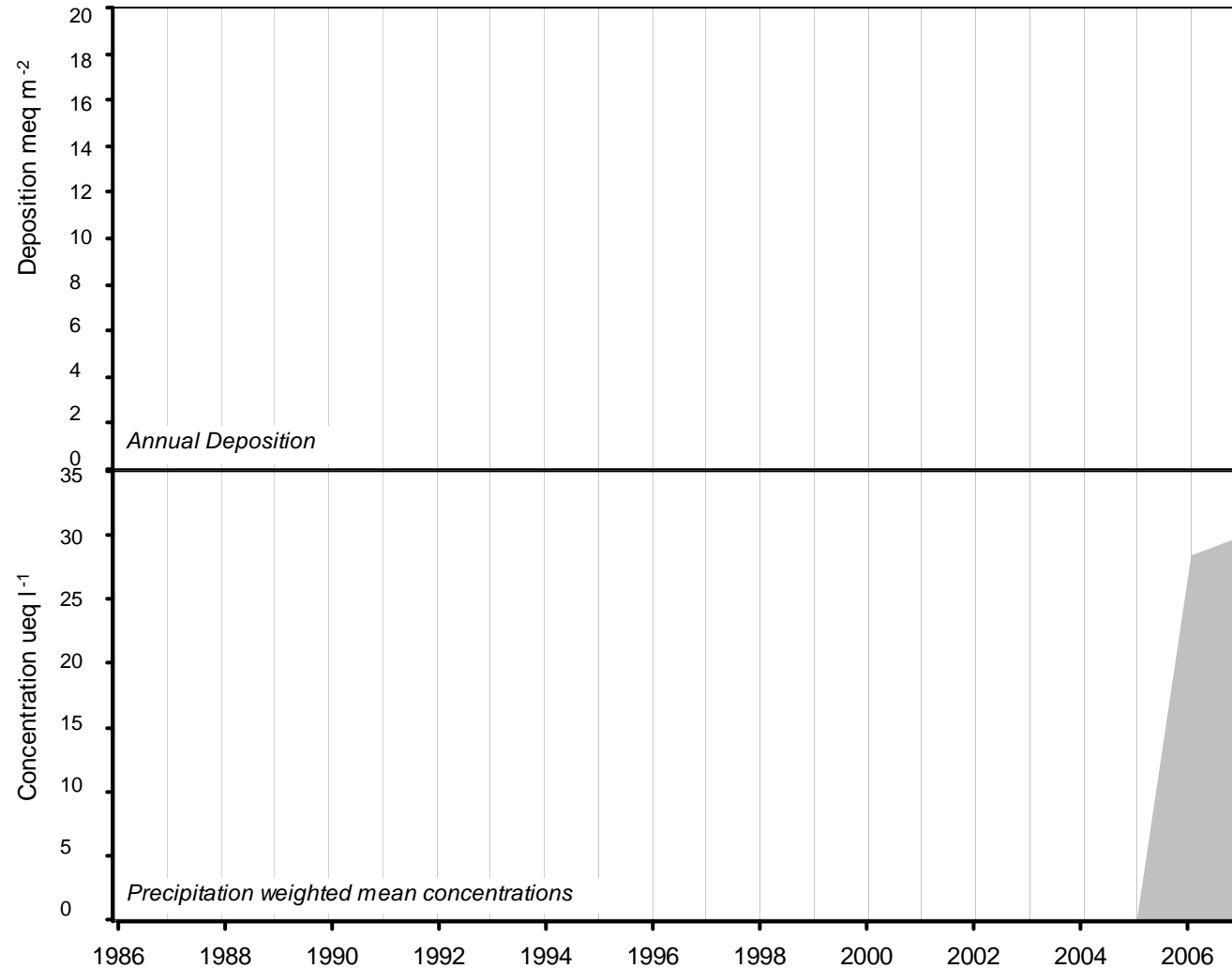



(5166) Forsinain 2

Start Date	End Date	pH	SO4 (µeq/l)	NO3 (µeq/l)	NH4 (µeq/l)	Na (µeq/l)	Mg (µeq/l)	Ca (µeq/l)	Cl (µeq/l)	K (µeq/l)	PO4 (µeq/l)	Nss SO4 (µeq/l)	H+ (µeq/l)	Conductivity (S/cm)	Rainfall (mm)	
14/Jan/2007	12/Feb/2007	5.3	40.4	8.9	32.5	320.1	61.0	15.1	343.4	11.1	<1.0	1.9	5.5	51.7	25.9	
12/Feb/2007	26/Feb/2007	5.7	36.9	15.2	16.3	271.3	56.3	37.5	225.3	3.9	<1.0	4.2	1.9	44.8	26.7	
26/Feb/2007	11/Mar/2007	5.7	46.0	21.5	23.3	344.6	63.3	20.7	388.6	15.4	<1.0	4.5	1.9	54.4	21.3	
11/Mar/2007	25/Mar/2007	5.7	111.9	9.8	17.5	893.6	186.7	43.2	1049.7	21.6	<1.0	4.2	2.0	132.2	11.9	
25/Mar/2007	23/Apr/2007	4.7	44.1	31.8	23.4	224.1	53.5	30.2	243.6	7.9	<1.0	17.1	20.0	-	3.0	
23/Apr/2007	07/May/2007	4.7	40.1	29.3	97.6	110.5	17.7	10.3	116.4	21.7	27.7	26.8	20.0	-	3.1	
07/May/2007	20/May/2007	5.8	39.6	16.8	44.9	143.8	21.3	12.6	152.3	16.3	2.7	22.2	1.5	29.7	25.1	
20/May/2007	04/Jun/2007	6.5	23.7	5.2	77.4	100.4	11.7	7.2	106.9	9.8	14.4	11.6	0.3	26.4	40.5	
04/Jun/2007	18/Jun/2007	-	-	-	-	-	-	-	-	-	-	-	-	-	0.0	
18/Jun/2007	02/Jul/2007	6.3	46.7	22.7	233.0	110.1	11.5	6.0	129.1	30.4	26.0	33.4	0.5	48.4	32.9	
02/Jul/2007	30/Jul/2007	6.4	21.2	6.1	58.4	56.8	4.3	1.6	60.8	9.8	4.9	14.3	0.4	17.2	107.2	
30/Jul/2007	13/Aug/2007	6.5	20.6	4.6	113.6	62.3	8.8	4.9	60.8	13.0	17.3	13.1	0.3	25.4	98.6	
13/Aug/2007	27/Aug/2007	6.2	46.2	5.3	78.2	236.2	33.0	10.3	264.8	18.2	27.2	17.7	0.7	32.6	32.4	
27/Aug/2007	10/Sep/2007	5.0	39.4	2.8	116.4	241.9	44.8	13.4	266.6	18.8	11.1	10.3	10.0	-	17.0	
10/Sep/2007	24/Sep/2007	6.3	61.0	<0.7	52.4	299.6	56.4	16.8	326.9	13.2	17.0	24.9	0.5	46.8	36.6	
24/Sep/2007	07/Oct/2007	5.3	96.5	<0.7	280.3	951.6	123.4	36.1	1049.4	52.8	18.3	0.0	5.0	-	1.8	
07/Oct/2007	19/Nov/2007	6.0	84.9	5.8	6.9	695.5	149.8	46.9	744.6	18.4	2.9	1.1	1.0	99.3	18.5	
19/Nov/2007	13/Dec/2007	5.8	62.6	3.0	5.1	515.0	108.5	52.5	551.1	16.2	2.8	0.6	1.5	66.7	25.0	
13/Dec/2007	31/Dec/2007	5.0	28.3	11.1	4.8	183.9	38.4	12.4	198.3	4.2	<1.0	6.2	11.2	31.6	42.2	
31/Dec/2007	14/Jan/2008	5.7	23.6	3.4	14.3	182.7	34.4	9.5	203.3	8.1	2.8	1.6	1.9	27.1	30.7	
			Precipitation<weighted annual means for site(samples containing phosphate are excluded)													Total rainfall
5166			37.9	9.3	30.6	245.8	47.3	17.5	263.3	10.8	2.6	8.3	2.9		600.4	



## Appendix 2

# Tables of Annual Mean Concentrations and Total Rainfall 1986 – 2007

### Notes to Tables A.2.1 to A.2.10:

- (1) The monitoring programme in 2001 was severely affected by the outbreak of Foot and Mouth disease, which prevented access to the sampling sites. The evaluation of the rainfall volumes indicates that the rainfall collected at the high rainfall sites is likely to be understated [Hayman *et al.* (2003a)].
- (2) Annual mean precipitation-weighted concentrations for 2001 have not been included for the Scoat Tarn (5159) and Whiteadder (5106) sites as sampling was suspended for more than five months of 2001 (Foot and Mouth restrictions).
- (3) No acidity measurements are available for 2000 as these were removed from the 2000 dataset due to uncertainty over the analyses [Hayman *et al.*, 2001d].

**Appendix 2.1 Precipitation-weighted annual mean acidity, 1986 to 2007 (ueq/l)**

	1986	1987	1988	1989	1990	1991	1992	1993	1994	1995	1996	1997	1998	1999	2000	2001	2002	2003	2004	2005	2006	2007
Goonhilly	19.7	23.3	15.1	19.4	14.3	25.9	15.4	17.7	19.8	17.5	19.5	20.3	14.2	13.3	22.5	30.8	21.8	14.6	17.9	16.7	22.1	
Yarner Wood	17.2	20.3	14.2	20.0	13.1	17.1	17.6	17.2	18.1	15.1	17.9	18.0	12.5	13.6	22.9	17.3	21.7	13.9	16.2	14.1	11.0	
Barcombe Mills	18.9	22.1	13.4	14.7	11.9	20.3	17.1	24.3	16.4	15.6	14.2	16.3	11.3	12.5	17.4	20.8	17.3	9.8	8.6	7.6	9.6	
Compton	25.3	28.0	16.2	25.0	14.2	17.6	35.3	34.2	22.7	12.5	6.8	12.0	11.4	6.6	12.0	15.5	7.2	6.0	4.6	6.2	6.2	
Harwell																						11.2
Rothamsted																						12.0
Crai Reservoir														12.4		13.9	18.7	16.5	10.0	10.2	13.0	10.7
Flatford Mill	33.0	43.0	34.5	35.4	29.1	42.5	35.9	25.6	27.2	30.4	25.1	26.1	25.3	27.0	19.6	23.6	22.0	23.6	19.3	11.0	16.1	
Woburn	44.8	49.6	37.0	37.0	27.8	34.8	36.7	27.6	29.9	22.2	15.1	23.6	25.1	13.5	23.3	28.0	19.6	12.7	8.5	45.7		
Tycanol Wood	15.7	16.8	15.1	18.4	13.8	21.0	20.7	17.7	14.2	14.4	15.8	12.6	11.0	11.3	14.1	15.8	17.8	12.0	11.9	16.9	9.5	
Ystradffin																						9.1
Llyn Brianne	16.1	21.1	17.8	18.8	17.2	24.3	20.2	19.8	16.2	12.2	14.0	14.7	11.9	11.4	0.0	16.3	23.5	8.4	9.5			
Pumlumon				13.9	11.8	16.0	17.8	19.2	13.1	14.5	14.5	11.9	9.3	9.7	9.8	10.3	12.9	5.4	7.6	7.7	8.9	
Stoke Ferry	34.6	35.8	29.7	40.4	18.2	22.3	29.8	27.7	18.4	23.7	15.7	19.5	18.4	17.4	15.3	27.7	19.2	11.8	8.9	11.3	10.1	
Preston Montford	17.6	24.7	24.5	36.3	13.5	26.5	37.8	35.9	29.8	26.9	18.8	16.4	7.9	6.5	9.1	16.0	13.1	7.5	2.7	7.8	11.1	
Bottesford	61.1	75.8	81.0	48.2	42.3	62.4	68.1	62.2	36.0	29.2	21.5	22.5	19.8	16.7	19.4	28.6	14.1	14.9	13.6	8.4	12.1	
Llyn Llagi														13.0	14.7	13.3	15.8	9.5	10.8	9.3	11.9	
Llyn Llydaw	16.6	18.8	17.2	15.4	12.3	15.6	13.7	18.5	11.6	10.5	12.4	10.5	11.2	12.3	14.1	17.2	12.3	9.1	9.8	11.2	9.5	
Ulceby Cross																						
Wardlow Hay Cop	28.8	44.5	33.2	36.8	23.7	32.6	33.9	36.5	27.0	28.3	22.1	18.1	16.0	10.3	19.0	22.8	9.0	5.7	4.9	4.5	7.1	
Driby	42.1	42.5	42.4	46.6	41.0	40.6	44.9	35.6	35.9	36.6	18.2	21.8	34.1	21.4	22.5	29.2	48.7	12.6	21.0	17.7	27.8	
River Etherow														24.6	28.8	34.4	27.7	13.8	11.9	11.2	17.1	
Jenny Hurn	88.7	99.9	82.3	63.5	53.7	79.9	80.6	67.9	38.6	58.2	53.8	55.2	45.0	33.2	30.8							
Thorganby	75.1	69.0	88.0	83.5	63.7	55.4	81.5	80.9	44.4	51.3	43.5	28.8	43.0	16.2	25.8	30.2	16.8	15.5	9.7	9.5	11.9	
High Muffles	58.2	62.9	71.9	54.7	55.0	58.1	59.4	47.5	41.5	40.9	39.6	32.5	34.6	22.1	38.0	36.0	22.4	16.9	18.5	17.5	18.1	
Bannisdale	29.7	26.6	28.2	23.7	18.3	22.0	24.8	31.2	19.4	17.3	20.1	16.1	15.0	13.0	23.6	18.8	16.6	10.1	6.1	8.9	6.5	
Scoat Tarn														13.9	0.0	17.7	19.4	10.3	9.6	9.2	10.5	
Hillsborough Forest				13.2	7.4	11.9	12.4	17.3	11.7	8.3	13.3	5.8	7.2	8.9	7.4	3.9	3.1	2.5	2.5	2.3	3.1	
Lough Navar	11.2	9.5	9.6	9.7	8.1	6.0	7.7	11.2	7.1	7.8	6.1	6.5	5.5	6.1	8.2	7.8	6.0	4.5	2.6	5.7	5.6	
Cow Green Reservoir	27.1	31.3	33.9	23.1	21.2	23.6	27.6	33.5	20.9	17.0	23.7	11.0	16.0	13.4	0.0	19.6	14.6	10.6	7.9			
Moorhouse																					9.9	11.3
Loch Dee	28.9	23.3	18.6	14.6	15.2	18.5	16.6	22.3	15.2	13.4	19.3	11.4	10.0	11.6	19.2	13.2	14.4	11.8	9.4	10.5	8.8	
Beaghs Burn														9.3	14.4	14.6	4.6	5.0	4.7	3.2	7.7	
Percy's Cross																						23.7
Redesdale	40.9	44.2	51.9	32.5	29.8	33.1	42.2	31.2	30.9	25.4	33.1	26.8	25.4	16.3	25.5	24.5	20.2	16.0	10.0	8.4	11.0	
Eskdalemuir	19.6	25.0	27.3	19.6	23.9	21.5	21.9	26.2	16.9	15.8	17.4	16.7	13.8	14.0	21.9	16.7	14.0	7.7	10.6	9.0	12.1	
Whiteadder	39.7	36.0	47.1	35.0	30.7	36.5	45.3	34.6	32.5	32.0	30.7	31.6	22.6	19.1	0.0	34.5	21.4	20.5	18.2	25.6	22.5	
Loch Chon														15.7	23.5	21.9	21.4	13.3	11.8	12.6	11.5	
Balquhidder	20.7	32.4	24.1	20.4	16.2	22.0	19.8	24.5	22.3	17.6	28.8	15.0	15.3	12.4	21.8	24.4	20.3	13.7	10.1	9.1	11.7	
Polloch				18.6	13.7	13.8	15.1	12.7	11.5	16.3	9.7	8.4	8.8	8.8	13.1	13.0	15.0	7.6	6.8	10.1	9.3	
Lochnagar														19.8	33.6	42.8	24.7	16.7	15.5	18.2	16.4	
Glen Dye		44.7	45.6	35.8	39.4	44.4	40.9	36.0	41.8	41.5	56.0	32.4	28.5	21.8	39.5	39.0	30.4	22.6	14.6			
Glensaugh																					24.0	25.2
Allt a' Mharcaidh	21.6	21.7	20.9	19.6	17.9	17.2	16.7	17.2	18.2	16.2	18.8	16.0	11.4	10.2	16.9	18.8	13.9	10.8	12.2	11.8	10.8	
Strathvaich Dam		15.7	16.1	12.9	11.2	15.4	19.9	13.4	10.6	10.4	12.9	12.0	9.7	9.5	11.9	13.4	11.3	9.9	6.4	9.5	9.2	
Forsinain2																				9.7	2.9	
Achanarras	9.7	18.6	25.4	25.3	19.5	20.1	24.3	22.5	16.8	16.1	21.1	21.3	14.4	13.6	19.5	25.4	11.4	9.7	8.4			

**Appendix 2.2 Precipitation-weighted annual mean non-seasalt (marine) sulphate, 1986 to 2007 (ueq/l)**

	1986	1987	1988	1989	1990	1991	1992	1993	1994	1995	1996	1997	1998	1999	2000	2001	2002	2003	2004	2005	2006	2007	
Goonhilly	30	34	21	29	25	36	22	30	28	24	31	25	17	17	19	22	20	24	18	22	30	17	
Yarner Wood	27	37	22	27	19	28	25	28	28	24	33	27	18	18	14	19	16	19	18	24	18	10	
Barcombe Mills	46	50	40	44	38	52	43	33	36	33	38	25	30	26	21	25	25	35	36	29	23	34	
Compton	79	104	64	60	58	63	63	48	55	49	61	42	38	32	26	28	27	29	32	37	25	10	
Harwell																						16	
Rothamsted																						26	23
Crai Reservoir														18	14	20	11	16	10	13	14	12	
Flatford Mill	90	71	66	80	55	71	53	42	50	52	52	41	43	44	34	33	35	39	35	33	28	27	
Woburn	73	80	85	73	66	63	57	44	59	46	56	39	42	38	30	34	32	33	34	43	92		
Tycanol Wood	27	26	23	26	22	31	27	23	23	24	27	19	18	21	16	19	15	15	17	18	21	13	
Ystradffin																						10	
Llyn Brianne	24	29	26	27	27	30	28	27	26	22	26	20	19	17	15	0	14	17	11	21			
Pumlumon				19	19	24	24	23	18	21	23	17	14	14	11	12	10	12	10	12	11	8	
Stoke Ferry	80	76	66	84	79	77	67	54	61	50	52	49	42	40	41	34	35	41	37	41	31	25	
Preston Montford	45	60	56	60	37	66	64	48	52	60	49	32	27	24	25	30	32	23	21	24	17	15	
Bottesford	90	93	109	83	66	75	73	58	63	55	54	43	45	39	33	42	40	44	34	38	32	25	
Llyn Llagi														17	17	16	12	15	12	16	10	12	
Llyn Llydaw	53	33	25	22	19	23	22	25	21	20	24	14	16	17	13	15	13	12	12	13	10	9	
Uiceby Cross																							
Wardlow Hay Cop	70	92	83	80	73	85	73	72	76	65	78	59	50	49	41	53	40	42	37	38	30	30	
Driby	69	74	77	79	80	78	65	50	62	70	49	42	53	41	37	40	33	40	36	37	30	22	
River Etherow														39	32	42	30	29	30	31	22	23	
Jenny Hurn	110	106	121	98	88	83	77	61	80	65	81	58	70	54	51	53							
Thorganby	85	79	88	87	82	119	87	79	72	56	69	62	60	50	45	51	41	50	40	41	44	29	
High Muffles	63	74	82	73	67	75	71	56	60	51	65	47	49	37	36	40	34	39	32	34	28	24	
Bannisdale	42	38	45	40	41	38	42	45	37	37	44	31	30	27	22	27	20	25	19	24	21	15	
Scoat Tarn														23	17	0	15	17	15	16	12	15	
Hillsborough Forest				52	36	42	41	41	45	33	45	26	29	30	23	33	18	17	17	17	19	14	
Lough Navar	19	16	15	18	14	18	17	19	17	17	17	15	12	10	11	12	8	10	10	8	7	7	
Cow Green Reservoir	35	39	44	35	33	34	38	41	31	31	37	26	26	25	19	0	17	18	16	16			
Moorhouse																						12	14
Loch Dee	32	35	36	24	26	28	27	29	25	24	36	18	19	19	19	22	11	15	18	17	13	15	
Beaghs Burn														37	16	21	11	12	10	13	18	8	
Percy's Cross																						20	
Redesdale	58	46	62	47	36	43	46	36	42	37	51	37	34	25	23	29	22	24	26	19	19	15	
Eskdalemuir	30	30	33	28	32	30	28	30	28	28	28	24	20	20	15	21	13	19	14	16	10	10	
Whiteadder	53	48	61	47	33	45	50	37	40	43	44	33	27	24	24	0	28	19	23	26	26	22	
Loch Chon														18	16	17	14	13	14	17	10	7	
Balquhidder	26	33	28	24	22	27	23	26	24	21	38	21	19	15	15	19	15	16	13	15	10	8	
Polloch				17	17	17	17	14	17	16	18	11	10	9	9	9	8	8	9	6	7	6	
Lochnagar															23	20	27	27	21	15	18	14	10
Glen Dye		48	49	41	39	45	43	39	47	41	62	31	29	25	21	29	23	27	19	17			
Glensaugh																						25	19
Allt a' Mharcaidh	24	24	20	19	15	16	16	18	18	14	23	13	11	9	9	14	11	9	12	10	7	7	
Strathvaich Dam		16	14	12	10	13	18	14	10	11	16	12	9	7	7	7	7	7	7	11	5	5	
Forsinain2																					18	8	
Achanarras	25	34	32	29	23	24	25	21	21	19	25	21	17	16	12	15	14	14	11	14			

**Appendix 2.3 Precipitation-weighted annual mean nitrate, 1986 to 2007 (ueq/l)**

	1986	1987	1988	1989	1990	1991	1992	1993	1994	1995	1996	1997	1998	1999	2000	2001	2002	2003	2004	2005	2006	2007
Goonhilly	19	27	16	22	20	32	17	23	24	23	28	28	18	20	17	24	23	28	20	27	33	26
Yarner Wood	16	24	14	19	13	19	16	21	25	21	31	27	14	17	11	20	17	18	20	30	20	11
Barcombe Mills	27	31	26	30	24	36	25	19	29	28	28	23	21	25	16	22	23	31	25	30	18	17
Compton	39	46	38	36	28	36	39	29	34	28	36	33	29	27	24	24	24	27	33	40	23	8
Harwell																						18
Rothamsted																						30
Crai Reservoir														10	8	13	9	15	9	12	12	10
Flatford Mill	39	45	42	56	36	44	40	31	37	39	38	36	39	41	31	35	37	43	44	46	29	33
Woburn	39	40	39	47	35	40	36	31	47	35	39	35	35	38	27	39	33	34	38	49	121	
Tycanol Wood	12	15	12	15	11	18	14	12	16	15	18	16	11	13	10	14	12	15	13	16	14	12
Ystradffin																						12
Llyn Brianne	12	14	13	14	16	18	16	15	18	16	17	17	12	12	10	0	13	18	11	23		
Pumlumon				10	9	14	13	14	12	15	16	14	7	10	8	9	8	10	9	11	11	9
Stoke Ferry	48	44	39	55	45	48	43	36	43	39	37	41	38	40	39	34	35	41	40	47	35	29
Preston Montford	22	32	26	31	20	35	38	28	32	38	33	24	19	21	22	29	23	20	23	25	18	15
Bottesford	41	41	45	50	34	43	36	34	40	33	34	33	30	33	29	36	38	37	31	41	31	24
Llyn Llagi														13	9	12	11	13	10	17	11	10
Llyn Llydaw	17	16	13	11	10	12	10	15	13	15	15	11	10	12	9	12	11	11	10	13	9	9
Uiceby Cross																						
Wardlow Hay Cop	25	36	31	36	26	38	29	33	35	33	40	30	24	28	25	35	28	29	30	31	24	24
Driby	39	44	48	48	46	50	46	38	49	50	39	40	45	39	35	38	34	38	35	41	35	24
River Etherow														31	24	36	25	28	29	32	21	23
Jenny Hurn	44	48	44	51	43	45	42	34	47	42	45	38	45	40	37	38						
Thorganby	41	42	42	49	40	50	42	46	40	37	38	38	34	32	34	37	33	31	31	41	37	24
High Muffles	38	43	47	45	38	47	37	37	42	38	43	35	36	32	31	38	31	34	31	35	28	27
Bannisdale	20	18	21	19	17	22	19	24	22	21	25	22	18	21	16	23	16	20	17	23	15	15
Scoat Tarn														16	12	0	13	16	15	17	14	14
Hillsborough Forest				26	16	23	16	21	23	21	29	19	16	22	13	25	14	13	17	17	20	13
Lough Navar	8	8	7	9	7	9	9	11	15	12	10	12	6	6	7	9	8	6	8	9	7	6
Cow Green Reservoir	19	22	25	20	20	21	23	25	21	22	24	18	18	20	17	0	17	21	17	22		
Moorhouse																					14	19
Loch Dee	14	19	18	14	14	16	15	19	18	16	22	14	13	13	14	18	9	14	12	17	13	11
Beaghs Burn														13	10	19	11	11	9	12	13	9
Percy's Cross																						27
Redesdale	34	26	33	31	26	31	36	26	33	27	33	35	30	25	23	31	22	31	25	27	22	18
Eskdalemuir	14	18	19	18	15	19	16	19	19	19	20	15	17	14	19	14	18	14	20	13	14	
Whiteadder	34	29	42	34	23	32	35	30	34	31	35	30	24	22	25	0	28	22	24	23	30	19
Loch Chon														19	14	16	13	14	14	16	11	9
Balquhidder	13	21	16	13	10	17	13	18	17	14	24	16	13	12	12	20	14	17	13	16	10	10
Polloch				12	9	9	9	10	11	10	10	8	5	6	6	8	7	7	6	7	7	6
Lochnagar														18	17	26	29	23	18	21	14	12
Glen Dye		31	32	31	29	33	28	33	42	36	42	29	27	24	25	37	28	34	26	25		
Glensaugh																					36	26
Allt a' Mharcaidh	10	12	11	10	9	10	8	7	15	11	14	11	9	8	9	13	11	10	11	13	7	9
Strathvaich Dam		10	8	7	6	9	9	9	9	9	10	10	6	8	6	7	8	7	6	5	8	4
Forsinain2																					15	9
Achanarras	14	22	24	25	18	22	16	18	21	18	22	21	15	12	14	15	18	13	12	14		

**Appendix 2.4 Precipitation-weighted annual mean ammonium, 1986 to 2007 (ueq/l)**

	1986	1987	1988	1989	1990	1991	1992	1993	1994	1995	1996	1997	1998	1999	2000	2001	2002	2003	2004	2005	2006	2007
Goonhilly	17	22	12	18	16	25	15	30	13	17	25	21	10	12	13	18	15	20	16	15	29	19
Yarner Wood	16	28	14	19	13	22	17	23	25	20	37	26	14	17	9	19	15	16	20	28	26	10
Barcombe Mills	38	41	36	39	35	50	31	16	30	33	32	22	18	25	14	23	20	25	21	19	20	25
Compton	71	73	46	57	55	63	57	41	53	53	79	53	48	44	29	36	31	32	44	56	37	21
Harwell																						20
Rothamsted																						31
Crai Reservoir														10	6	12	7	14	8	11	15	11
Flatford Mill	141	50	49	66	41	59	40	32	40	48	49	38	43	45	34	41	38	39	37	33	36	36
Woburn	54	50	52	56	43	52	41	35	55	48	63	40	36	47	29	44	37	28	44	55	120	
Tycanol Wood	13	15	13	15	14	19	13	12	15	18	22	15	12	16	10	18	15	16	13	17	20	19
Ystradffin																						15
Llyn Brianne	12	13	14	16	16	20	18	16	16	18	19	15	13	14	12		14	15	11	23		
Pumlumon				13	13	17	20	15	13	21	18	16	10	12	7	12	15	11	11	11	15	13
Stoke Ferry	65	60	56	75	67	75	54	43	61	53	56	55	49	50	49	45	38	50	48	78	48	37
Preston Montford	47	57	49	53	44	57	57	37	50	54	60	38	36	38	30	51	76	37	34	64	28	24
Bottesford	56	45	49	68	54	48	40	34	55	48	56	45	45	48	37	49	48	47	39	46	45	33
Llyn Llagi														12	8	11	10	12	10	18	14	15
Llyn Llydaw	14	11	16	15	14	13	15	15	11	14	17	10	11	14	8	12	11	11	10	13	14	11
Uiceby Cross																						
Wardlow Hay Cop	34	40	39	39	40	57	45	39	47	46	58	38	33	37	30	44	35	35	40	37	40	32
Driby	53	60	64	53	67	76	55	42	48	64	54	49	49	44	39	49	35	41	42	37	41	14
River Etherow														34	25	40	28	28	32	36	31	28
Jenny Hurn	64	51	53	64	64	65	45	28	55	50	66	53	61	46	45	54						
Thorganby	59	55	61	65	80	124	82	65	57	60	57	59	53	50	42	51	44	41	39	49	53	40
High Muffles	40	46	54	53	48	64	44	40	50	48	61	44	45	37	34	39	34	41	36	36	38	33
Bannisdale	40	27	31	30	32	34	27	31	32	36	40	33	27	27	23	33	23	27	23	38	55	25
Scoat Tarn														21	14		16	18	18	20	21	20
Hillsborough Forest				60	45	48	40	44	49	43	63	40	38	43	39	54	35	33	34	44	42	39
Lough Navar	11	9	8	11	8	10	12	11	11	16	14	14	9	9	10	10	12	7	10	10	12	9
Cow Green Reservoir	20	19	25	23	24	26	25	29	21	30	26	27	20	23	19		18	21	18	24		
Moorhouse																					22	23
Loch Dee	21	34	22	20	21	24	28	22	23	19	27	17	17	19	17	22	12	19	13	27	20	21
Beaghs Burn															20	15	26	16	17	15	17	18
Percy's Cross																					20	28
Redesdale	41	15	23	34	24	32	30	21	30	33	44	37	32	28	24	34	25	37	43	30	63	27
Eskdalemuir	19	16	20	22	18	26	17	18	21	26	24	24	18	20	15	20	15	30	25	23	19	17
Whiteadder	30	20	35	32	17	30	27	22	24	28	33	24	21	20	23		25	19	22	22	28	18
Loch Chon														12	12	12	16	12	12	17	12	10
Balquhidder	14	15	12	14	11	16	16	16	12	12	24	18	14	12	8	16	12	27	12	18	15	12
Polloch				6	8	8	8	6	6	7	7	6	5	5	3	7	8	6	6	6	7	5
Lochnagar														16	16	20	19	20	15	17	13	9
Glen Dye		26	29	28	25	32	22	28	33	29	43	23	22	22	20	30	19	30	20	21		
Glensaugh																					43	23
Allt a' Mharcaidh	6	10	4	7	5	5	4	4	8	5	7	5	5	6	4	8	4	6	10	8	5	7
Strathvaich Dam		4	3	4	3	5	5	4	4	5	5	6	4	4	3	4	5	3	3	2	7	2
Forsinain2																					19	31
Achanarras	13	35	21	18	15	26	9	9	12	15	14	13	13	11	10	12	12	19	6	9		

**Appendix 2.5 Precipitation-weighted annual mean sodium, 1986 to 2007 (ueq/l)**

	1986	1987	1988	1989	1990	1991	1992	1993	1994	1995	1996	1997	1998	1999	2000	2001	2002	2003	2004	2005	2006	2007	
Goonhilly	264	206	212	276	506	327	238	228	265	270	313	284	292	292	299	226	283	223	298	236	394	343	
Yarner Wood	98	125	150	166	245	141	104	101	123	128	127	118	127	88	104	91	204	111	131	99	147	137	
Barcombe Mills	186	255	156	204	357	137	128	99	147	176	195	164	154	177	199	91	203	131	153	155	213	169	
Compton	55	67	70	84	129	71	40	55	64	64	76	77	58	55	45	37	62	43	45	53	58	57	
Harwell																						55	
Rothamsted																						41	49
Crai Reservoir														96	103	79	122	101	106	70	94	116	
Flatford Mill	99	60	54	79	85	70	57	55	73	79	76	60	59	49	63	49	67	60	51	69	55	69	
Woburn	71	65	50	60	87	54	28	41	56	51	61	58	36	46	34	31	41	48	43	59	86		
Tycanol Wood	116	90	104	232	232	163	120	120	164	157	146	159	145	151	144	103	166	146	146	113	181	159	
Ystradffin																							134
Llyn Brianne	94	68	83	112	152	111	72	97	90	84	94	96	90	103	90		116	111	106	88			
Pumlumon				104	141	102	72	70	73	79	81	113	95	85	92	69	136	96	82	66	113	108	
Stoke Ferry	74	49	50	58	86	75	57	53	54	46	71	55	56	55	44	60	37	53	49	57	50	69	
Preston Montford	86	38	86	39	100	164	38	66	58	64	35	80	40	54	33	31	58	44	48	53	63	38	
Bottesford	82	35	59	47	62	54	35	36	39	49	58	27	33	39	25	29	41	39	40	50	40	32	
Llyn Llagi														110	90	75	116	99	133	90	136	136	
Llyn Llydaw	126	78	122	135	194	162	95	112	98	129	97	107	88	104	70	72	82	67	90	65	87	82	
Uiceby Cross																							
Wardlow Hay Cop	70	52	90	57	140	131	57	95	94	66	82	60	65	70	40	50	58	67	91	52	56	65	
Driby	95	53	64	98	94	103	67	71	83	100	121	58	77	65	62	74	79	68	60	88	57	78	
River Etherow														60	46	47	65	64	102	68	66	60	
Jenny Hurn	97	47	74	68	104	55	37	47	53	54	73	36	61	51	30	39							
Thorganby	74	51	52	69	90	96	50	52	52	51	59	45	67	53	33	44	35	40	30	42	41	85	
High Muffles	61	63	67	95	92	103	78	111	88	113	153	82	106	76	61	76	57	98	55	90	65	104	
Bannisdale	122	62	133	116	161	182	91	107	95	129	95	156	101	131	76	73	88	78	127	73	122	147	
Scoat Tarn														85	71		76	71	80	70	110	89	
Hillsborough Forest				89	140	107	72	87	125	108	107	78	97	90	90	70	65	74	99	104	61	88	
Lough Navar	248	102	317	139	261	192	133	188	174	125	116	131	136	171	152	98	151	173	125	121	121	193	
Cow Green Reservoir	74	40	69	76	90	84	74	72	77	93	91	99	89	100	55		73	71	70	66			
Moorhouse																					88	74	
Loch Dee	116	54	136	132	147	123	86	79	92	106	91	109	91	124	101	56	103	92	94	96	111	135	
Beaghs Burn														171	150	128	139	172	161	192	128	163	
Percy's Cross																						56	
Redesdale	114	44	66	91	67	80	59	73	76	75	93	55	65	65	49	45	59	62	73	58	80	175	
Eskdalemuir	86	37	62	81	86	102	53	63	77	88	63	66	76	102	61	85	63	66	73	62	78	96	
Whiteadder	112	53	83	92	78	59	79	104	120	100	121	93	80	86	93	81	119	49	93	78	65		
Loch Chon														112	69	71	128	88	63	77	83	138	
Balquhidder	122	45	59	110	102	89	61	146	120	71	122	87	81	122	83	59	84	95	67	102	105	82	
Polloch				173	213	118	205	155	168	148	127	161	194	150	139	234	159	154	191	156	180		
Lochnagar														39	33	35	76	45	40	38	34	28	
Glen Dye		52	73	83	81	78	65	89	108	98	121	112	91	83	71	77	89	72	52	88			
Glensaugh																					85	90	
Allt a' Mharcaidh	90	37	45	88	62	46	57	143	92	57	66	70	65	83	63	40	44	75	57	96	61	79	
Strathvaich Dam		83	109	126	175	147	121	212	154	102	130	116	122	180	153	95	105	235	125	165	189	124	
Forsinain2																					398	246	
Achanarras	231	145	217	277	215	235	186	225	217	169	219	167	202	249	251	186	216	340	196	339			



**Appendix 2.1 Precipitation-weighted annual mean magnesium, 1986 to 2007 (ueq/l)**

	1986	1987	1988	1989	1990	1991	1992	1993	1994	1995	1996	1997	1998	1999	2000	2001	2002	2003	2004	2005	2006	2007
Goonhilly	61	48	49	63	119	77	57	55	64	73	86	82	87	93	73	50	63	48	57	50	80	74
Yarner Wood	23	30	35	38	58	32	26	29	33	38	37	35	41	37	24	20	45	24	28	21	31	28
Barcombe Mills	44	62	36	49	84	34	33	29	40	48	58	48	48	58	47	21	46	30	38	34	49	54
Compton	14	19	21	21	31	18	11	15	18	20	25	26	26	27	10	8	14	10	11	12	11	11
Harwell																						11
Rothamsted																						9
Crai Reservoir														40	24	19	27	23	21	15	20	25
Flatford Mill	32	17	16	23	23	19	15	16	18	20	21	17	20	18	16	12	16	14	12	17	14	15
Woburn	9	12	13	18	24	14	9	13	15	15	18	18	13	19	8	8	10	11	10	13	13	
Tycanol Wood	27	21	24	53	54	39	29	31	43	45	43	45	48	54	32	22	36	30	31	23	38	31
Ystradffin																						27
Llyn Brianne	21	16	20	27	36	27	19	27	25	24	29	27	32	41	20		25	24	21	17		
Pumlumon				24	32	23	19	20	23	25	25	33	35	37	21	15	29	20	17	14	23	21
Stoke Ferry	20	12	13	16	23	18	16	16	16	12	21	16	19	22	11	14	9	13	11	14	11	15
Preston Montford	21	11	22	11	24	43	11	18	20	42	15	25	25	27	9	7	12	9	9	10	12	7
Bottesford	26	11	18	16	18	16	11	10	12	14	16	10	14	17	6	8	11	11	11	11	11	8
Llyn Llagi														40	21	16	25	21	28	18	28	27
Llyn Llydaw	29	18	26	31	44	37	24	30	28	37	31	32	33	41	16	16	18	14	18	13	18	16
Ulceby Cross																						
Wardlow Hay Cop	17	15	25	17	35	32	15	25	27	18	24	18	23	27	9	12	14	15	20	12	13	14
Driby	24	14	19	27	27	26	18	23	22	26	34	18	23	23	15	17	19	17	14	19	14	18
River Etherow														21	11	11	15	14	23	14	14	12
Jenny Hurn	36	16	29	25	34	21	14	16	22	19	24	13	22	20	10	13						
Thorganby	22	16	17	23	27	31	16	15	19	15	19	16	23	27	10	13	12	14	9	12	13	21
High Muffles	15	17	19	23	29	27	19	30	23	29	39	21	30	26	15	18	13	23	13	21	15	22
Bannisdale	29	15	33	27	38	44	23	28	27	35	27	41	32	48	17	16	18	18	27	15	24	28
Scoat Tarn														32	16		16	15	16	14	19	18
Hillsborough Forest				21	31	24	20	25	36	34	29	27	42	38	21	15	14	14	20	18	12	15
Lough Navar	57	24	80	32	60	47	34	49	48	38	37	40	53	63	43	21	32	37	25	24	24	41
Cow Green Reservoir	17	10	17	18	22	20	19	20	22	25	25	29	29	41	13		16	16	15	13		
Moorhouse																					18	14
Loch Dee	29	12	31	31	35	29	22	23	25	31	28	34	35	48	27	12	22	19	20	19	21	27
Beaghs Burn														64	46	28	30	35	33	49	48	32
Percy's Cross																						12
Redesdale	26	12	19	23	18	19	15	20	21	21	27	17	21	26	13	10	13	13	16	12	15	34
Eskdalemuir	20	9	15	20	21	25	14	18	22	26	20	20	30	41	16	14	13	14	15	13	16	19
Whiteadder	26	13	22	23	20	15	19	27	33	26	31	26	25	33	22		18	25	11	20	18	14
Loch Chon														40	16	16	28	19	14	16	17	28
Balquhiddy	29	11	14	26	25	21	16	38	31	22	33	24	28	52	18	13	18	19	14	21	22	16
Polloch					40	48	30	53	40	46	41	37	54	68	35	29	50	34	32	40	29	36
Lochnagar														17	8	8	17	10	9	9	7	6
Glen Dye		12	18	22	21	19	16	23	26	25	30	28	26	28	16	18	20	16	13	19		
Glensaugh																						18
Allt a' Mharcaidh	21	8	12	20	15	11	14	35	24	16	20	19	23	35	16	9	10	16	12	20	11	16
Strathvaich Dam		20	25	28	39	32	31	52	42	31	40	33	42	68	40	20	22	44	26	35	29	25
Forsinain2																						75
Achanarras	55	37	46	64	49	54	46	56	58	45	59	43	61	83	57	41	47	71	41	77		

**Appendix 2.7 Precipitation-weighted annual mean calcium, 1986 to 2007 (ueq/l)**

	1986	1987	1988	1989	1990	1991	1992	1993	1994	1995	1996	1997	1998	1999	2000	2001	2002	2003	2004	2005	2006	2007
Goonhilly	16	15	14	18	31	22	18	19	19	24	23	21	27	30	20	14	15	19	17	15	23	22
Yarner Wood	11	15	12	13	17	15	12	13	18	18	16	16	20	22	10	8	13	9	12	10	12	10
Barcombe Mills	20	29	22	30	33	32	22	20	28	29	37	25	49	43	20	16	23	21	39	36	31	37
Compton	26	51	33	22	32	30	23	21	34	41	55	34	61	36	15	13	14	26	20	21	18	5
Harwell																						13
Rothamsted																						19
Crai Reservoir														18	8	17	8	10	8	8	9	12
Flatford Mill	33	21	27	37	24	24	18	21	25	21	22	18	25	25	15	13	17	23	17	19	19	16
Woburn	23	30	38	28	32	24	19	19	24	21	34	23	28	33	11	12	13	21	16	22	12	16
Tycanol Wood	12	9	9	31	17	13	11	11	14	17	16	15	19	26	10	9	9	10	10	11	12	11
Ystradffin																						11
Llyn Brianne	7	8	9	10	15	10	10	11	12	12	12	11	17	19	7		8	11	8	9		
Pumlumon				7	11	11	9	8	9	12	10	12	14	17	7	6	7	7	6	6	8	7
Stoke Ferry	31	22	24	28	43	33	32	26	30	22	35	34	33	39	16	16	16	27	19	28	21	20
Preston Montford	14	19	19	14	14	37	18	17	24	76	28	18	34	28	9	10	10	11	10	10	11	7
Bottesford	36	33	50	33	23	29	19	18	23	29	25	21	31	31	10	14	14	28	18	20	21	14
Llyn Llagi														16	9	6	7	7	11	7	9	9
Llyn Llydaw	9	10	13	9	12	11	11	11	14	18	13	11	14	16	6	6	6	6	6	7	8	6
Ulceby Cross																						
Wardlow Hay Cop	45	59	56	55	75	57	55	52	64	55	69	64	89	92	28	39	27	40	31	30	27	30
Driby	18	19	27	34	33	27	18	19	28	35	30	21	26	26	12	14	17	23	15	17	20	15
River Etherow														22	10	14	9	12	14	14	12	11
Jenny Hurn	56	45	75	48	49	39	27	26	60	31	35	23	44	38	19	21						
Thorganby	25	25	30	37	35	67	27	24	67	29	32	33	53	57	18	29	18	37	22	21	27	27
High Muffles	13	21	23	27	20	23	21	20	25	26	23	21	20	28	10	14	12	19	13	15	14	15
Bannisdale	13	12	14	13	15	16	15	14	16	17	16	17	20	28	8	8	8	11	11	10	10	11
Scoat Tarn														16	7		5	6	6	6	9	9
Hillsborough Forest				13	14	17	16	15	24	25	24	21	36	34	11	11	8	8	9	9	13	8
Lough Navar	17	11	21	12	18	25	19	24	27	26	25	23	29	33	15	11	10	13	9	11	13	18
Cow Green Reservoir	7	8	12	12	13	11	13	12	13	16	14	13	16	23	7		7	11	7	8		
Moorhouse																					10	8
Loch Dee	10	9	11	9	11	10	11	10	11	14	10	12	23	19	10	5	5	6	7	7	8	9
Beaghs Burn														61	37	8	7	17	8	45	46	10
Percy's Cross																						9
Redesdale	12	10	20	18	11	14	13	11	18	13	16	13	13	19	8	7	6	9	16	8	8	10
Eskdalemuir	7	5	8	21	8	10	8	10	14	13	8	10	17	17	6	6	4	6	7	7	7	7
Whiteadder	14	14	20	16	11	13	12	12	18	19	15	13	14	19	9	9	8	9	7	11	12	16
Loch Chon														13	5	6	7	7	5	9	8	8
Balquhiddier	8	5	6	9	8	11	8	12	10	9	10	9	16	19	7	6	6	7	6	8	9	7
Polloch					9	16	13	13	14	13	12	11	20	24	9	7	10	9	9	12	10	11
Lochnagar														10	4	5	5	6	5	6	5	6
Glen Dye		7	10	11	10	9	10	11	12	10	10	10	10	15	6	6	6	11	6	9		
Glensaugh																					9	8
Allt a' Mharcaidh	10	8	7	8	7	6	9	12	12	7	11	9	13	17	6	5	4	6	6	6	7	6
Strathvaich Dam		7	7	8	13	9	10	14	14	11	15	11	16	20	11	6	5	10	8	10	10	8
Forsinain2																					19	18
Achanarras	16	15	20	20	21	17	17	19	18	17	18	15	20	28	14	11	12	18	14	18		

**Appendix 2.8 Precipitation-weighted annual mean chloride, 1986 to 2007 (ueq/l)**

	1986	1987	1988	1989	1990	1991	1992	1993	1994	1995	1996	1997	1998	1999	2000	2001	2002	2003	2004	2005	2006	2007	
Goonhilly	311	242	253	322	595	373	265	256	296	313	368	320	324	325	353	266	320	222	332	255	353	364	
Yarner Wood	118	152	180	190	291	161	122	117	139	147	149	133	143	98	124	108	230	123	142	113	154	145	
Barcombe Mills	226	310	190	252	425	161	156	116	166	202	230	187	180	200	237	111	235	157	184	171	234	196	
Compton	55	92	94	110	159	89	54	73	74	81	91	89	68	64	55	45	75	51	52	58	63	60	
Harwell																						58	
Rothamsted																						41	
Crai Reservoir														116	125	94	139	115	115	73	99	123	
Flatford Mill	109	80	70	99	101	88	71	68	79	95	90	68	69	57	75	58	77	68	59	75	58	71	
Woburn	82	82	61	75	109	69	38	51	64	61	66	64	41	52	40	36	48	51	49	62	75		
Tycanol Wood	141	109	123	266	268	190	135	135	178	184	171	178	162	169	173	121	187	167	167	123	182	168	
Ystradffin																						142	
Llyn Brianne	107	83	99	131	178	129	81	110	100	95	107	106	101	117	105		131	125	119	101			
Pumlumon				124	165	118	83	77	83	91	95	127	108	97	110	80	152	108	92	77	120	116	
Stoke Ferry	95	65	66	73	103	89	72	64	62	57	86	62	63	62	51	71	44	58	54	64	53	73	
Preston Montford	109	56	114	59	123	203	50	84	72	84	46	94	47	63	42	37	66	53	58	57	66	42	
Bottesford	115	58	100	78	97	85	62	63	55	67	74	37	42	43	32	37	51	47	47	54	41	35	
Llyn Llagi														124	106	87	132	113	149	101	140	144	
Llyn Llydaw	154	83	137	156	225	185	107	128	105	149	112	120	99	120	85	84	95	74	94	73	90	88	
Uiceby Cross																							
Wardlow Hay Cop	97	85	131	84	183	163	78	122	113	87	104	74	78	80	50	59	69	72	104	60	59	67	
Driby	128	76	90	126	135	123	88	85	98	125	144	69	90	78	75	88	91	80	68	93	58	87	
River Etherow														69	57	56	76	73	76	72	68	62	
Jenny Hurn	169	99	146	123	170	124	86	84	83	99	111	72	89	68	47	57							
Thorganby	140	100	121	139	166	180	123	107	96	96	90	64	107	73	49	59	49	51	41	51	46	88	
High Muffles	89	96	106	131	146	140	110	139	108	146	187	98	126	88	73	92	68	110	63	100	69	112	
Bannisdale	148	75	168	141	193	213	107	125	109	151	113	178	114	149	88	85	100	90	145	83	96	152	
Scoat Tarn														95	83		87	80	88	77	100	89	
Hillsborough Forest				106	165	123	84	102	140	130	123	89	110	102	106	83	78	85	105	106	64	95	
Lough Navar	293	125	409	166	298	222	153	215	191	144	135	150	155	188	179	118	172	197	139	139	128	209	
Cow Green Reservoir	91	52	85	91	107	98	86	85	89	108	105	117	100	113	66		83	76	82	73			
Moorhouse																						84	80
Loch Dee	152	67	159	159	173	144	96	90	106	121	106	123	102	138	120	65	121	104	102	109	109	127	
Beaghs Burn														194	178	151	158	207	163	203	115	175	
Percy's Cross																						59	
Redesdale	133	54	84	112	83	97	72	92	86	89	108	62	74	73	60	54	69	64	83	63	74	177	
Eskdalemuir	105	47	76	97	103	118	65	72	85	101	74	74	87	113	73	98	73	76	85	69	82	98	
Whiteadder	129	64	100	110	93	69	93	118	132	115	139	104	91	97	112		93	128	54	105	80	72	
Loch Chon														129	82	82	146	100	73	90	84	146	
Balquhidder	146	58	70	131	125	104	70	167	135	83	146	100	92	140	98	69	97	105	78	118	110	87	
Polloch				205	249	135	227	169	191	176	143	183	226	180	163	275	174	175	211	164	196		
Lochnagar														43	39	41	85	50	45	42	35	30	
Glen Dye		64	86	98	98	91	78	103	124	115	146	124	103	93	83	94	102	77	59	97			
Glensaugh																						82	105
Allt a' Mharcaidh	104	39	52	104	72	53	65	158	99	66	76	82	75	93	73	46	51	87	67	104	49	83	
Strathvaich Dam		101	129	148	207	168	138	228	169	116	149	131	138	201	179	114	118	265	141	226	163	139	
Forsinain2																						411	263
Achanarras	279	174	253	317	251	272	209	255	245	195	246	189	225	280	302	220	244	381	228	352			

**Appendix 2.9 Precipitation-weighted annual mean sulphate, 1986 to 2007 (ueq/l)**

	1986	1987	1988	1989	1990	1991	1992	1993	1994	1995	1996	1997	1998	1999	2000	2001	2002	2003	2004	2005	2006	2007
Goonhilly	61	59	47	63	85	75	50	57	58	56	69	59	52	51	55	49	54	47	51	50	62	56
Yarner Wood	39	52	40	47	49	44	38	40	43	39	48	41	34	28	27	30	40	33	32	36	35	25
Barcombe Mills	68	80	59	68	81	68	58	45	54	54	61	45	48	47	45	36	49	51	54	48	48	54
Compton	85	112	72	70	73	71	67	55	63	57	70	51	45	38	32	33	35	34	37	43	32	17
Harwell																						23
Rothamsted																						31
Crai Reservoir														29	27	30	26	28	22	22	25	26
Flatford Mill	102	78	73	89	65	79	60	49	58	62	61	48	50	50	42	39	43	46	41	42	35	35
Woburn	82	86	91	81	76	70	60	49	66	52	63	46	46	44	34	38	37	39	39	50	102	
Tycanol Wood	41	37	36	54	50	51	41	37	42	40	45	38	36	39	34	31	35	33	35	32	36	32
Ystradffin																						26
Llyn Brianne	36	37	36	40	46	43	36	39	37	32	38	31	30	29	26		28	30	24	31		
Pumlumon				32	36	35	32	31	27	30	33	31	26	23	22	20	25	23	19	19	25	21
Stoke Ferry	89	82	72	91	90	86	74	61	68	56	61	55	49	47	46	41	39	47	43	48	37	34
Preston Montford	56	65	66	65	49	85	69	56	59	68	53	42	31	30	29	33	39	28	27	31	24	19
Bottesford	100	98	116	89	73	82	77	62	67	61	61	47	49	43	36	46	45	48	39	44	37	29
Llyn Llagi															30	28	25	26	27	26	27	26
Llyn Llydaw	61	39	41	38	42	43	34	38	32	35	35	27	27	30	21	23	23	20	21	20	21	19
Ulceby Cross																						
Wardlow Hay Cop	79	98	94	87	90	100	80	83	87	73	88	66	58	58	45	59	47	50	48	44	36	37
Driby	80	80	85	91	91	91	73	58	72	82	64	49	62	49	45	49	43	48	43	47	37	31
River Etherow															46	38	48	38	37	36	39	30
Jenny Hurn	121	112	130	107	100	90	81	66	86	72	90	62	78	60	55	57						
Thorganby	94	85	94	96	93	126	94	85	78	62	76	68	69	56	49	56	46	54	44	45	48	39
High Muffles	70	82	90	85	78	87	80	70	70	65	83	57	62	46	44	50	41	51	39	45	36	37
Bannisdale	57	45	61	54	60	60	53	58	48	53	55	50	42	38	31	36	31	34	34	33	30	30
Scoat Tarn															33	26		24	26	25	25	24
Hillsborough Forest				63	53	55	50	51	60	46	58	36	41	41	33	41	26	26	29	28	25	25
Lough Navar	49	28	34	34	46	41	33	41	37	31	31	28	30	29	24	24	26	30	24	22	20	28
Cow Green Reservoir	44	43	53	44	44	44	47	49	40	43	48	38	36	34	26		26	26	24	24		
Moorhouse																					22	23
Loch Dee	47	41	52	39	43	43	37	38	36	37	47	31	29	34	31	29	23	26	26	29	24	26
Beaghs Burn															58	34	36	28	33	26	36	33
Percy's Cross																						26
Redesdale	72	51	70	58	44	52	53	44	51	46	63	44	42	33	28	35	29	31	34	26	26	29
Eskdalemuir	40	35	41	38	42	43	34	37	38	38	36	32	30	31	23	28	21	27	22	24	19	21
Whiteadder	66	55	72	58	42	52	59	50	54	55	58	44	37	35	35		38	34	29	37	35	29
Loch Chon															26	24	26	29	24	22	26	20
Balquhidder	41	39	35	37	34	38	31	44	38	30	52	31	29	29	25	26	25	27	21	27	22	18
Polloch					36	42	31	39	34	33	36	26	30	32	27	26	36	26	23	29	24	25
Lochnagar															27	24	31	36	27	20	22	18
Glen Dye		54	58	51	49	54	51	49	60	53	76	44	40	35	30	39	34	35	26	28		
Glensaugh																					35	30
Allt a' Mharcaidh	35	29	26	29	23	22	23	33	29	21	31	22	19	19	17	19	16	17	17	20	11	15
Strathvaich Dam		26	27	27	31	30	33	35	28	22	32	26	24	25	26	18	19	30	21	28	22	18
Forsinain2																					51	38
Achanarras	52	50	57	63	48	52	47	48	45	40	51	41	41	46	42	37	40	52	34	52		

**Appendix 2.10 Annual volume of rain samples collected (multi-day bulk rain), 1986 to 2007 (mm)**

	1986	1987	1988	1989	1990	1991	1992	1993	1994	1995	1996	1997	1998	1999	2000	2001	2002	2003	2004	2005	2006	2007
Goonhilly	907	879	910	753	790	800	776	1008	999	744	743	1000	936	831	934	787	1025	743	819	711	632	857
Yarner Wood	1150	1016	1123	1131	1174	1058	1049	1398	1333	1135	1007	1218	1383	1106	1315	1026	1342	668	1012	697	1097	1180
Barcombe Mills	740	849	678	597	639	620	654	739	806	652	539	818	733	655	1215	834	923	506	568	538	684	631
Compton	589	629	530	550	407	449	709	644	585	647	392	576	642	644	855	701	805	466	671	525	614	23
Harwell																						829
Rothamsted																						934
Crai Reservoir														2190	2292	1659	2207	1305	2187	1403	1268	678
Flatford Mill	528	660	532	392	393	362	510	518	438	335	231	409	493	546	613	615	586	372	465	373	534	479
Woburn	758	672	592	540	400	478	694	656	505	515	328	456	620	537	662	670	651	448	595	423	8	
Tycanol Wood	1508	1318	1385	1340	1437	1422	1572	1692	1460	1320	1366	1589	1576	1246	1734	1287	1808	1246	1324	1107	1567	1374
Ystradffin																						519
Llyn Brianne	1491	1497	1434	1417	1483	1224	1488	1573	1474	1143	1195	1296	1737	1725	1983	286 *	1567	1303	1709	520		
Pumlumon				1896	1936	1908	2129	2124	2445	1622	1554	1780	2641	2230	2410	1547	2193	1752	2204	1793	2036	1671
Stoke Ferry	503	617	537	495	348	350	508	601	479	375	318	519	517	435	577	597	694	440	539	444	585	525
Preston Montford	539	570	514	580	538	443	555	585	520	409	403	550	590	666	789	535	554	534	560	485	587	734
Bottesford	545	651	531	469	434	377	557	651	526	327	289	596	573	540	682	572	614	400	461	478	475	586
Llyn Llagi														2177	2979	1925	2608	2431	2239	1827	3155	2850
Llyn Llydaw	2758	2231	2794	2480	2394	2028	3014	2152	2375	2097	1574	2068	2777	2313	3086	1831	1916	2238	2573	2258	2565	2253
Ulceby Cross																						
Wardlow Hay Cop	928	889	837	708	711	617	850	853	977	581	530	853	1018	860	1068	786	1066	665	793	786	950	903
Driby	702	685	605	457	473	398	676	636	514	375	415	578	620	598	616	597	568	483	617	507	454	602
River Etherow														876	1205	914	1261	758	1002	915	1097	1056
Jenny Hurn	518	652	390	443	351	354	505	546	451	460	301	423	530	554	610	511						
Thorganby	503	625	516	364	434	329	511	485	496	395	348	477	448	597	703	542	609	441	605	475	578	590
High Muffles	711	875	855	599	806	626	836	947	740	670	693	827	980	936	1160	861	879	670	826	704	846	660
Bannisdale	2259	2101	2091	1699	2270	1857	2027	1794	2289	1690	1328	1771	2167	1798	2552	1606	2082	1756	2247	1583	2313	2004
Scoat Tarn														2110	2727	1651 *	2618	1980	2467	2325	2627	2261
Hillsborough Forest				642	909	668	635	802	614	742	662	824	777	730	900	515	893	532	709	685	715	801
Lough Navar	1439	1144	1492	1242	1617	1459	1978	1517	1631	1521	1373	1395	1686	1383	1297	1004	1358	941	1237	999	1429	1234
Cow Green Reservoir	1129	1216	1138	858	1165	957	1073	1118	1293	807	1149	1058	1353	1275	1633	860 *	1411	1033	1627	899		
Moorhouse																					1612	1099
Loch Dee	2373	2311	2619	2001	2574	2196	2659	1950	2393	2036	1928	2269	2473	2373	1438	1249	2055	1646	1990	1303	1950	1862
Beaghs Burn														1417	1695	1148	1494	1044	1458	1270	1415	1438
Percy's Cross																						564
Redesdale	745	828	832	499	724	581	662	585	541	507	444	437	843	632	842	553	1002	509	874	538	687	132
Eskdalemuir	1523	1276	1396	1236	1528	1248	1609	1330	1630	1202	1211	1487	1700	1479	1628	1180	1780	1070	1381	1132	1577	1324
Whiteadder	585	718	712	489	721	569	665	722	566	473	395	546	750	583	817	499 *	722	416	544	292	412	689
Loch Chon														2123	1838	1399	2278	1696	1706	1454	2053	1834
Balquhiddier	2008	1428	1736	1967	2398	1683	1815	1575	1547	1637	1096	1579	1540	1863	1674	1254	1704	1138	1746	1335	1993	1485
Polloch				707	2021	2355	1790	2012	1788	1606	1904	2250	2098	2011	1171	1800	1675	2520	1963	1814	1915	
Lochnagar														987	1436	956	1885	959	1367	1215	1428	1235
Glen Dye		898	1067	659	809	691	759	968	637	724	740	1049	1005	792	1238	998	1320	554	840	722		
Glensaugh																					760	804
Allt a' Mharcaidh	778	664	761	638	907	729	757	826	714	678	477	601	846	874	895	593	786	496	781	628	749	785
Strathvaich Dam		959	1205	1357	1713	1396	1609	1148	1273	1282	885	1200	1458	1444	1383	997	1173	1129	1395	1230	1498	1186
Forsinain2																					569	600
Achanarras	901	864	642	476	776	512	635	567	535	622	488	478	700	646	598	586	663	548	686	698		

\* Sampling reduced due to foot and mouth restrictions during 2001



## **Appendix 3**

# **Particulate Sulphate Measurements 2007**

Monthly and Annual Mean Concentrations of Particulate Sulphate in 2007  
 Concentration in Air ( $\mu\text{g SO}_4$  [as S]  $\text{m}^{-3}$ )

Site	Site code	Monthly Mean												2007 Annual Mean
		Jan 07	Feb 07	Mar 07	Apr 07	May 07	Jun 07	Jul 07	Aug 07	Sep 07	Oct 07	Nov 07	Dec 07	
Eskdalemuir	5002	0.37	0.53	0.86	0.42	0.32	0.58	0.59	0.38	0.21	0.46	-	0.35	0.45
Lough Navar	5006	0.26	0.32	0.65	0.65	-	-	-	-	-	-	0.27	0.34	-
Barcombe Mills	5007	-	0.58	0.88	1.17	-	1.12	-	0.79	-	-	0.48	-	-
Yarner Wood	5008	0.29	0.39	0.66	-	-	0.77	-	-	-	-	-	0.51	-
High Muffles	5009	0.26	-	-	0.60	-	0.66	0.34	-	-	-	-	-	-

Note: - indicates that no average was determined as the data capture was less than 75%.



Site: 5002 Eskdalemuir - Sulphate as S (SO<sub>4</sub> - S)  
Concentration in air (µg S m<sup>-3</sup>)

Daily measurements - Summary for January 2007 to December 2007

MONTH DATE	JAN	FEB	MAR	APR	MAY	JUN	JUL	AUG	SEP	OCT	NOV	DEC
1 - 2	0.15	0.87	0.31	0.45	1.00	0.56	0.29	0.18	0.18	0.27	0.21	0.12
2 - 3	0.38	0.38	0.52	0.74	0.43	0.61	0.25	0.39	0.15	0.70	0.32	0.13
3 - 4	0.39	0.45	0.46	0.24	0.52	0.58	0.20	0.28	0.16	0.48	0.19	0.13
4 - 5	0.43	0.76	0.51	0.27	0.65	0.77	0.36	0.24	0.20	0.09	0.49	0.15
5 - 6	0.49	0.39	0.39	0.29	1.67	0.71	1.99	0.49	0.21	0.13	0.20	0.26
6 - 7	0.50	0.37	0.53	0.66	0.26	1.72	0.64	0.29	0.15	0.73	0.26	0.19
7 - 8	0.41	0.48	0.44	0.62	0.23	1.74	0.49	0.43	0.18	0.51	N	0.10
8 - 9	0.39	0.48	0.26	0.29	0.11	1.52	0.47	0.56	0.39	0.78	N	0.17
9 - 10	0.40	0.87	0.50	0.14	0.30	N	0.80	0.32	0.29	0.41	N	0.10
10 - 11	0.36	0.58	1.00	0.12	0.18	N	0.24	0.32	0.23	0.78	N	0.10
11 - 12	0.43	0.49	0.73	0.21	0.29	0.07	1.17	0.53	0.40	0.41	N	0.19
12 - 13	0.55	0.36	0.42	0.26	0.27	N	0.27	0.27	0.72	0.24	N	0.30
13 - 14	0.38	0.46	0.67	1.01	0.28	0.30	0.29	0.28	0.41	0.39	N	0.54
14 - 15	0.53	0.49	1.22	1.15	0.16	0.33	0.60	0.67	0.20	1.13	N	0.92
15 - 16	0.43	0.68	0.61	0.93	0.14	0.46	0.62	0.53	0.28	0.56	0.26	0.85
16 - 17	0.39	0.65	0.49	0.22	0.09	0.51	0.66	0.30	0.16	0.14	0.33	0.96
17 - 18	0.37	0.35	0.53	0.18	0.17	0.51	0.57	0.30	0.13	0.09	0.24	0.89
18 - 19	0.39	0.64	0.41	0.27	0.24	1.56	0.89	0.51	0.09	0.07	0.27	0.88
19 - 20	0.36	0.95	0.46	0.20	0.16	1.39	0.67	0.34	0.06	0.38	0.48	0.87
20 - 21	0.36	0.45	0.43	0.51	0.21	0.17	0.59	0.79	0.20	0.64	N	0.70
21 - 22	0.35	0.50	0.31	1.10	0.24	0.29	1.44	0.72	0.14	0.77	0.14	0.51
22 - 23	0.36	0.69	0.41	0.29	0.32	0.29	0.56	0.39	0.26	0.39	0.19	0.33
23 - 24	0.37	0.72	0.68	0.12	0.29	0.21	0.39	0.93	0.20	0.89	0.24	0.20
24 - 25	0.37	0.51	1.03	0.32	0.19	0.22	0.41	0.20	0.08	0.55	0.21	0.09
25 - 26	0.40	0.41	1.76	0.26	0.13	0.09	0.39	0.15	0.08	1.10	0.12	0.21
26 - 27	0.36	0.38	1.90	0.21	0.15	0.16	0.32	0.17	0.15	0.55	0.20	0.21
27 - 28	0.32	0.44	2.25	0.23	0.15	0.20	0.60	0.23	0.15	0.14	0.35	0.22
28 - 29	0.36	0.12	1.73	0.41	0.26	0.18	0.81	0.22	0.17	0.10	0.15	0.22
29 - 30	0.17		2.56	0.72	0.13	0.22	0.32	0.16	0.17	0.08	0.07	0.13
30 - 31	0.13		2.47	0.21	0.39	0.22	0.47	0.18	0.17	0.25	0.14	0.16
31 - 1	0.35		0.69		0.38		0.54	0.42		0.45		0.08
Arithmetic Mean (3)	0.37	0.53	0.86	0.42	0.32	0.58	0.59	0.38	0.21	0.46	-	0.35
Standard Deviation (3)	0.09	0.19	0.67	0.30	0.31	0.53	0.38	0.20	0.13	0.30	-	0.30
Sample Size	31	28	31	30	31	27	31	31	30	31	21	31

Notes (1) N = no measurement; (2) Measurements preceded by < are below the Limit of Detection. The measurement has been included in the calculation of the statistical parameters at 50% of its value; (3) Statistical parameters calculated only if data capture is greater than 75%.

Site: 5006 Lough Navar - Sulphate as S (SO<sub>4</sub> - S)  
Concentration in air (µg S m<sup>-3</sup>)

Daily measurements - Summary for January 2007 to December 2007

MONTH DATE	JAN	FEB	MAR	APR	MAY	JUN	JUL	AUG	SEP	OCT	NOV	DEC
1 - 2	0.25	0.07	0.18	0.86	0.53	N	N	N	0.13	N	N	0.17
2 - 3	1.14	0.23	0.41	1.42	0.46	N	0.04	N	0.04	N	N	0.13
3 - 4	0.37	0.44	0.19	0.65	0.44	N	0.04	N	0.77	N	N	0.13
4 - 5	0.22	0.09	0.32	0.29	1.10	N	0.03	N	0.73	N	N	0.17
5 - 6	0.26	0.63	0.24	0.35	0.75	N	0.03	N	0.24	N	N	0.20
6 - 7	0.24	0.20	0.27	0.60	0.25	N	0.04	N	0.27	N	N	0.15
7 - 8	0.18	0.17	0.21	0.64	0.66	N	1.47	N	0.38	N	N	0.00
8 - 9	N	0.37	0.38	0.48	0.40	N	0.71	N	0.22	N	0.33	0.19
9 - 10	N	0.67	0.43	0.56	0.28	N	0.15	N	0.37	N	0.06	0.12
10 - 11	N	0.67	0.46	0.22	0.23	N	0.35	N	N	N	0.41	0.09
11 - 12	N	0.23	0.23	0.33	0.25	N	0.20	N	N	N	0.20	0.19
12 - 13	N	0.23	0.25	0.90	0.60	N	0.20	N	N	N	0.27	0.25
13 - 14	N	0.75	0.64	1.48	0.89	N	0.34	0.25	N	N	0.38	0.30
14 - 15	N	0.32	0.92	2.12	N	N	0.49	0.06	N	N	0.15	0.50
15 - 16	0.24	0.22	0.26	0.94	N	N	0.76	0.20	N	N	0.63	0.97
16 - 17	0.26	0.27	0.49	0.27	N	N	N	0.10	N	N	0.31	0.75
17 - 18	0.19	0.21	0.33	0.26	N	N	N	0.17	N	N	0.22	0.81
18 - 19	0.31	0.36	0.27	0.34	N	N	N	0.15	N	N	0.26	0.71
19 - 20	0.10	0.28	0.31	0.25	N	N	N	0.10	N	N	0.53	0.92
20 - 21	0.08	0.30	0.19	1.42	N	N	N	0.20	N	N	0.51	0.85
21 - 22	0.20	0.29	0.27	1.33	N	N	N	0.42	N	N	0.29	0.84
22 - 23	0.21	0.36	0.28	0.30	N	N	N	0.40	N	N	0.16	0.10
23 - 24	0.21	0.33	0.53	0.22	N	N	N	0.16	N	N	0.20	0.18
24 - 25	0.21	0.22	1.09	0.33	N	N	N	0.07	N	N	0.28	0.15
25 - 26	0.20	0.29	1.63	0.06	N	N	N	0.12	N	N	0.18	0.19
26 - 27	0.18	0.24	2.20	0.23	N	N	N	0.15	N	N	0.18	0.28
27 - 28	0.20	0.29	2.08	0.38	N	N	N	0.87	N	N	0.12	0.31
28 - 29	0.21	0.25	0.22	0.53	N	N	N	0.27	N	N	0.16	0.18
29 - 30	0.23		0.52	1.15	N	N	N	0.25	N	N	0.17	0.19
30 - 31	0.28		2.39	0.51	N	N	N	0.07	N	N	0.10	0.21
31 - 1	0.23		1.99		N		N	0.11		N		0.26
Arithmetic Mean (3)	0.26	0.32	0.65	0.65	-	-	-	-	-	-	0.27	0.34
Standard Deviation (3)	0.20	0.17	0.67	0.49	-	-	-	-	-	-	0.14	0.29
Sample Size	24	28	31	30	13	0	14	19	9	0	23	31

Notes (1) N = no measurement; (2) Measurements preceded by < are below the Limit of Detection. The measurement has been included in the calculation of the statistical parameters at 50% of its value; (3) Statistical parameters calculated only if data capture is greater than 75%.

Site: 5007 Barcombe Mills - Sulphate as S (SO<sub>4</sub> - S)  
Concentration in air (µg S m<sup>-3</sup>)

Daily measurements - Summary for January 2007 to December 2007

MONTH DATE	JAN	FEB	MAR	APR	MAY	JUN	JUL	AUG	SEP	OCT	NOV	DEC
1 - 2	N	0.52	0.28	1.89	0.54	N	0.48	0.55	1.48	N	0.77	0.22
2 - 3	N	0.74	0.34	2.09	0.66	N	0.52	0.79	0.97	N	0.59	0.15
3 - 4	N	0.27	0.18	0.99	0.96	N	0.33	0.39	0.61	N	0.80	0.20
4 - 5	N	1.39	0.40	0.45	1.72	N	N	0.50	0.71	N	0.89	0.40
5 - 6	N	1.36	0.42	0.47	0.93	N	N	0.80	N	N	0.77	0.51
6 - 7	N	0.31	0.46	0.62	2.33	2.64	N	0.50	N	N	0.41	0.55
7 - 8	N	0.67	0.39	0.74	0.89	2.97	N	0.28	N	N	0.66	0.30
8 - 9	N	0.21	0.49	0.74	0.77	2.37	N	0.25	N	N	0.31	0.37
9 - 10	N	0.80	0.39	1.02	0.68	2.45	N	0.34	N	N	0.52	0.38
10 - 11	0.59	0.47	0.35	0.96	0.70	2.27	N	0.52	N	N	0.68	0.31
11 - 12	0.68	0.43	0.52	0.77	0.34	1.77	N	0.80	N	N	0.46	0.30
12 - 13	0.54	0.52	0.52	1.82	0.59	0.81	N	0.61	N	N	0.32	0.18
13 - 14	0.43	0.50	0.32	1.86	0.50	2.29	N	0.29	N	N	0.43	0.64
14 - 15	0.42	0.30	0.47	1.62	0.43	0.19	N	0.41	N	N	0.25	0.73
15 - 16	0.52	0.37	0.65	1.35	0.40	0.37	N	0.59	N	N	0.39	0.37
16 - 17	N	0.54	0.64	1.61	0.68	0.29	N	0.37	N	N	0.53	0.32
17 - 18	0.78	0.59	0.69	1.65	0.35	0.39	N	0.44	N	N	0.43	0.57
18 - 19	0.48	1.20	0.29	0.61	0.81	0.75	N	0.43	N	N	0.50	0.70
19 - 20	0.43	1.37	0.39	0.81	0.44	1.20	N	0.39	N	N	0.42	N
20 - 21	0.47	0.68	0.59	0.38	0.46	0.67	N	0.83	N	N	0.54	N
21 - 22	0.33	0.36	0.62	0.47	1.06	0.60	N	1.14	N	N	0.48	N
22 - 23	0.31	0.57	0.92	0.82	0.72	0.58	N	1.15	N	N	0.34	N
23 - 24	0.47	0.46	0.87	2.26	N	1.49	N	1.08	N	N	0.26	N
24 - 25	0.35	0.40	1.60	1.73	N	0.56	N	2.92	N	N	0.05	N
25 - 26	0.40	0.26	2.10	1.80	N	0.52	N	1.43	N	N	0.34	N
26 - 27	0.16	0.22	1.42	0.49	N	1.15	N	1.55	N	N	0.55	N
27 - 28	0.51	0.37	1.46	2.33	N	0.53	N	0.98	N	N	0.65	N
28 - 29	0.26	0.47	2.04	0.74	N	0.35	N	0.66	N	N	0.41	N
29 - 30	0.48		1.77	1.54	N	0.34	N	1.23	N	N	0.26	N
30 - 31	0.88		2.43	0.41	N	0.42	N	1.03	N	N	0.35	N
31 - 1	0.86		3.25		N		N	1.34		N		N
Arithmetic Mean (3)	-	0.58	0.88	1.17	-	1.12	-	0.79	-	-	0.48	-
Standard Deviation (3)	-	0.35	0.75	0.62	-	0.88	-	0.54	-	-	0.19	-
Sample Size	21	28	31	30	22	25	3	31	4	0	30	18

Notes (1) N = no measurement; (2) Measurements preceded by < are below the Limit of Detection. The measurement has been included in the calculation of the statistical parameters at 50% of its value; (3) Statistical parameters calculated only if data capture is greater than 75%.

Site: 5008 Yarner Wood - Sulphate as S (SO<sub>4</sub> - S)  
Concentration in air (µg S m<sup>-3</sup>)

Daily measurements - Summary for January 2007 to December 2007

MONTH DATE	JAN	FEB	MAR	APR	MAY	JUN	JUL	AUG	SEP	OCT	NOV	DEC
1 - 2	0.19	0.46	0.25	3.65	N	0.26	0.52	N	N	N	N	0.18
2 - 3	0.30	0.52	0.18	1.72	N	0.64	0.41	N	N	N	N	0.24
3 - 4	0.27	0.35	0.27	0.40	N	1.20	0.51	N	N	N	N	0.23
4 - 5	0.18	0.84	0.25	N	N	0.63	0.44	N	N	N	N	0.23
5 - 6	0.17	0.52	0.49	N	N	0.89	0.45	N	N	N	N	0.21
6 - 7	0.17	0.55	0.29	N	N	1.39	0.41	N	N	N	N	0.11
7 - 8	0.20	0.16	0.25	N	N	1.85	0.38	N	N	N	N	0.14
8 - 9	0.20	0.43	0.32	N	N	2.23	0.22	N	N	N	N	0.13
9 - 10	0.34	0.29	0.36	N	N	2.67	0.21	N	N	N	N	0.12
10 - 11	0.25	0.27	0.33	N	N	3.27	N	N	N	N	N	0.11
11 - 12	0.36	0.22	0.41	N	N	N	N	N	N	N	N	0.08
12 - 13	0.29	0.20	0.26	N	N	N	N	N	N	N	N	0.21
13 - 14	0.19	0.27	0.16	N	N	0.71	N	N	N	N	N	0.58
14 - 15	0.25	0.33	0.26	N	N	0.88	N	N	N	N	N	0.50
15 - 16	0.29	0.39	0.58	N	N	0.22	N	N	N	N	N	1.49
16 - 17	0.26	0.30	0.25	N	N	0.25	N	N	N	N	N	0.87
17 - 18	0.25	0.91	0.45	N	N	0.35	N	N	N	N	N	1.06
18 - 19	0.21	0.97	0.21	N	N	0.36	N	N	N	N	N	1.53
19 - 20	0.24	0.49	0.19	N	N	0.54	N	N	N	N	N	1.70
20 - 21	0.30	0.31	0.22	N	N	0.07	N	N	N	N	N	N
21 - 22	0.21	0.32	0.20	N	N	0.48	N	N	N	N	N	2.27
22 - 23	0.34	0.33	0.36	N	N	0.52	N	N	N	N	N	0.57
23 - 24	0.24	0.27	0.96	N	N	0.32	N	N	N	N	N	0.25
24 - 25	0.35	0.20	1.30	N	N	0.13	N	N	N	N	N	0.80
25 - 26	0.38	0.21	2.07	N	N	0.24	N	N	N	N	N	0.13
26 - 27	0.31	0.25	1.44	N	N	0.29	N	N	N	N	N	0.28
27 - 28	0.30	0.26	1.48	N	N	0.28	N	N	N	N	N	0.27
28 - 29	0.51	0.32	2.70	N	N	0.36	N	N	N	N	N	0.30
29 - 30	0.73		N	N	0.13	0.25	N	N	N	N	0.11	0.21
30 - 31	0.41		1.14	N	0.11	0.34	N	N	N	N	0.14	0.23
31 - 1	0.29		2.23		0.27		N	N		N		0.19
Arithmetic Mean (3)	0.29	0.39	0.66	-	-	0.77	-	-	-	-	-	0.51
Standard Deviation (3)	0.11	0.21	0.69	-	-	0.81	-	-	-	-	-	0.56
Sample Size	31	28	30	3	3	28	9	0	0	0	2	30

Notes (1) N = no measurement; (2) Measurements preceded by < are below the Limit of Detection. The measurement has been included in the calculation of the statistical parameters at 50% of its value; (3) Statistical parameters calculated only if data capture is greater than 75%.

Site: 5009 High Muffles - Sulphate as S (SO<sub>4</sub> - S)  
Concentration in air (µg S m<sup>-3</sup>)

Daily measurements - Summary for January 2007 to December 2007

MONTH DATE	JAN	FEB	MAR	APR	MAY	JUN	JUL	AUG	SEP	OCT	NOV	DEC
1 - 2	0.10	N	0.12	0.91	0.52	N	0.26	0.29	N	N	N	N
2 - 3	0.19	N	0.25	0.72	0.64	N	0.30	0.16	N	N	N	N
3 - 4	0.32	N	0.26	0.28	0.67	N	0.17	0.28	N	0.33	N	N
4 - 5	0.17	N	0.35	0.59	0.56	N	0.13	0.36	N	0.13	N	N
5 - 6	0.36	N	0.22	0.32	2.50	N	0.19	0.72	N	0.30	N	N
6 - 7	0.53	N	2.77	0.66	0.32	0.53	0.10	N	N	0.74	N	N
7 - 8	0.31	N	N	0.74	0.26	0.77	0.14	N	N	0.30	0.10	N
8 - 9	0.22	N	N	0.45	0.15	1.72	0.17	N	N	0.13	0.11	N
9 - 10	0.29	N	N	0.21	0.32	1.06	0.13	N	N	0.27	0.10	N
10 - 11	0.15	N	N	0.30	0.30	1.02	0.56	N	N	N	0.09	N
11 - 12	0.34	N	N	0.57	0.46	1.80	0.28	N	N	N	0.09	N
12 - 13	0.38	N	N	0.74	0.39	1.61	0.39	N	N	N	0.09	0.21
13 - 14	0.28	N	N	0.93	0.44	0.32	0.38	N	N	N	0.05	0.39
14 - 15	0.34	N	N	1.63	0.27	0.27	0.53	N	N	N	0.24	0.97
15 - 16	0.31	N	N	1.30	0.45	0.60	0.20	N	N	N	0.35	0.44
16 - 17	0.36	N	N	0.43	0.32	1.03	0.29	N	N	N	0.53	0.60
17 - 18	0.24	N	N	0.21	0.48	0.87	0.51	N	N	N	0.60	0.49
18 - 19	0.26	N	N	0.31	0.37	0.06	0.54	N	N	N	0.52	N
19 - 20	0.33	0.83	N	0.24	0.23	0.66	1.09	N	N	N	0.56	N
20 - 21	0.22	0.69	N	0.40	0.43	0.43	0.28	N	N	N	0.46	N
21 - 22	0.33	0.39	0.33	1.04	0.52	0.51	0.21	N	N	N	0.47	N
22 - 23	0.26	0.32	0.16	0.83	0.22	0.49	0.38	N	N	N	0.17	N
23 - 24	0.30	0.49	0.74	0.87	N	0.75	0.54	N	N	N	0.23	N
24 - 25	0.13	0.51	0.97	0.65	N	0.34	0.84	N	N	N	0.17	N
25 - 26	0.14	0.56	1.23	0.45	N	0.32	0.42	N	N	N	0.21	N
26 - 27	0.27	0.28	1.42	0.31	N	0.30	0.30	N	N	N	0.27	N
27 - 28	0.10	0.25	1.50	0.36	N	0.26	0.30	N	N	N	0.36	N
28 - 29	0.10	0.21	2.06	0.50	N	0.20	0.19	N	N	N	N	N
29 - 30	0.11		2.69	0.73	N	0.19	0.25	N	N	N	N	N
30 - 31	0.39		2.77	0.31	N	0.30	0.26	N	N	N	N	N
31 - 1	N		0.52		N		0.21	N		N		N
Arithmetic Mean (3)	0.26	-	-	0.60	-	0.66	0.34	-	-	-	-	-
Standard Deviation (3)	0.11	-	-	0.34	-	0.48	0.22	-	-	-	-	-
Sample Size	30	10	17	30	22	25	31	5	0	7	21	6

Notes (1) N = no measurement; (2) Measurements preceded by < are below the Limit of Detection. The measurement has been included in the calculation of the statistical parameters at 50% of its value; (3) Statistical parameters calculated only if data capture is greater than 75%.



## Appendix 4

### Nitrogen Dioxide Measurements 2007

- Appendix 4.1 Measurements from single tube sites
- Appendix 4.2 Measurements from triplicate tube sites (Yarner Wood, Harwell and Eskdalemuir)
- Appendix 4.3 Time series of NO<sub>2</sub> measurements from all sites

## Appendix 4.1 Measurements from Single Tube Sites

Nitrogen Dioxide  
Concentration in Air (ppb)Monthly measurements, collection-day - non standard  
Summary for January 2007 to December 2007

Site	Sampling Period	Start Date	End Date	Concentration (in ppb)	Site	Sampling Period	Start Date/Time	End Date/Time	Concentration (in ppb)	
Goonhilly	1	05-Dec-2006	24-Jan-2007	*	Yarner Wood	1	27-Dec-2006	24-Jan-2007	1.85	
	2	24-Jan-2007	21-Feb-2007	2.56		2	24-Jan-2007	21-Feb-2007	5.90	
	3	21-Feb-2007	23-Mar-2007	4.33		3	21-Feb-2007	21-Mar-2007	2.05	
	4	23-Mar-2007	23-Apr-2007	4.22		4	21-Mar-2007	18-Apr-2007	4.20	
	5	23-Apr-2007	18-May-2007	N		5	18-Apr-2007	18-May-2007	3.02	
	6	18-May-2007	15-Jun-2007	4.99		6	18-May-2007	12-Jun-2007	2.61	
	7	15-Jun-2007	02-Jul-2007	3.05		7	12-Jun-2007	11-Jul-2007	1.18	
	8	02-Jul-2007	09-Aug-2007	5.62		8	11-Jul-2007	08-Aug-2007	1.58	
	9	09-Aug-2007	06-Sep-2007	3.25		9	08-Aug-2007	05-Sep-2007	1.67	
	10	06-Sep-2007	03-Oct-2007	1.71		10	05-Sep-2007	03-Oct-2007	3.21	
	11	03-Oct-2007	12-Dec-2007	2.76		11	03-Oct-2007	31-Oct-2007	4.54	
	12	12-Dec-2007	11-Jan-2008	N		12	31-Oct-2007	28-Nov-2007	2.98	
	13			0.36		13	28-Nov-2007	26-Dec-2007	7.52	
	14					14	26-Dec-2007	21-Jan-2008	2.58	
Annual Mean Concentration =					Annual Mean Concentration = 3.26					
Flatford Mill	1	28-Nov-2006	09-Jan-2007	*	Tycanol Wood	1	29-Nov-2006	05-Jan-2007	2.59	
	2	09-Jan-2007	23-Jan-2007	10.43		2	05-Jan-2007	24-Jan-2007	1.72	
	3	23-Jan-2007	20-Feb-2007	9.58		3	24-Jan-2007	21-Feb-2007	3.13	
	4	20-Feb-2007	20-Mar-2007	8.88		4	21-Feb-2007	21-Mar-2007	1.58	
	5	20-Mar-2007	17-Apr-2007	8.24		5	21-Mar-2007	18-Apr-2007	2.83	
	6	17-Apr-2007	15-May-2007	6.46		6	18-Apr-2007	16-May-2007	3.14	
	7	15-May-2007	12-Jun-2007	7.26		7	16-May-2007	13-Jun-2007	2.95	
	8	12-Jun-2007	10-Jul-2007	2.32		8	13-Jun-2007	11-Jul-2007	1.57	
	9	10-Jul-2007	07-Aug-2007	4.54		9	11-Jul-2007	08-Aug-2007	0.69	
	10	07-Aug-2007	04-Sep-2007	3.89		10	08-Aug-2007	05-Sep-2007	1.98	
	11	04-Sep-2007	02-Oct-2007	3.88		11	05-Sep-2007	03-Oct-2007	5.61	
	12	02-Oct-2007	30-Oct-2007	6.46		12	03-Oct-2007	31-Oct-2007	1.33	
	13	30-Oct-2007	27-Nov-2007	6.04		13	31-Oct-2007	28-Nov-2007	2.68	
	14	27-Nov-2007	02-Jan-2008	9.81		14	28-Nov-2007	02-Jan-2008	6.87	
Annual Mean Concentration = 7.03					Annual Mean Concentration = 2.85					
Pumlumon	1	28-Nov-2006	02-Jan-2007	2.20	Llyn Llydaw	1	29-Nov-2006	10-Jan-2007	*	0.90
	2	02-Jan-2007	23-Jan-2007	1.14		2	10-Jan-2007	24-Jan-2007	1.54	
	3	23-Jan-2007	21-Feb-2007	3.46		3	24-Jan-2007	21-Feb-2007	2.88	
	4	21-Feb-2007	03-Apr-2007	2.27		4	21-Feb-2007	21-Mar-2007	1.79	
	5	03-Apr-2007	17-Apr-2007	3.40		5	21-Mar-2007	18-Apr-2007	2.73	
	6	17-Apr-2007	29-May-2007	*		6	18-Apr-2007	13-Jun-2007	*	2.43
	7	29-May-2007	12-Jun-2007	2.17		7	13-Jun-2007	11-Jul-2007	1.24	
	8	12-Jun-2007	10-Jul-2007	7.83		8	11-Jul-2007	08-Aug-2007	1.05	
	9	10-Jul-2007	07-Aug-2007	1.19		9	08-Aug-2007	05-Sep-2007	0.97	
	10	07-Aug-2007	04-Sep-2007	1.20		10	05-Sep-2007	03-Oct-2007	1.27	
	11	04-Sep-2007	02-Oct-2007	0.63		11	03-Oct-2007	31-Oct-2007	2.01	
	12	02-Oct-2007	30-Oct-2007	2.88		12	31-Oct-2007	28-Nov-2007	2.45	
	13	30-Oct-2007	27-Nov-2007	3.19		13	28-Nov-2007	02-Jan-2008	2.80	
	14	27-Nov-2007	02-Jan-2008	2.62		14				
Annual Mean Concentration = 2.77					Annual Mean Concentration = 1.97					

Notes: \* denotes extended sampling period (greater than 40 days). N denotes missing or excluded sample. Annual mean concentration only given if the data capture is greater than 75%.



Nitrogen Dioxide  
Concentration in Air (ppb)

Monthly measurements, collection-day - non standard  
Summary for January 2007 to December 2007

Site	Sampling Period	Start Date	End Date	Concentration (in ppb)	Site	Sampling Period	Start Date/Time	End Date/Time	Concentration (in ppb)		
Driby	1	20-Dec-2006	22-Jan-2007	7.85	High Muffles	1	29-Nov-2006	03-Jan-2007	5.68		
	2	22-Jan-2007	19-Feb-2007	10.18		2	03-Jan-2007	24-Jan-2007	4.47		
	3	19-Feb-2007	02-Apr-2007	5.94		3	24-Jan-2007	14-Feb-2007	4.59		
	4	02-Apr-2007	15-Jun-2007	*		N	4	14-Feb-2007	04-Apr-2007	*	4.72
	5	15-Jun-2007	04-Oct-2007	*		N	5	04-Apr-2007	25-Apr-2007	3.56	
	6	04-Oct-2007	01-Jan-2008	*		N	6	25-Apr-2007	23-May-2007	2.46	
	7						7	23-May-2007	13-Jun-2007	5.53	
	8						8	13-Jun-2007	11-Jul-2007	2.09	
	9						9	11-Jul-2007	08-Aug-2007	2.59	
	10						10	08-Aug-2007	06-Sep-2007	1.95	
	11						11	06-Sep-2007	03-Oct-2007	2.72	
	12						12	03-Oct-2007	31-Oct-2007	6.55	
	13						13	31-Oct-2007	28-Nov-2007	6.86	
	14						14	28-Nov-2007	03-Jan-2008	8.44	
Annual Mean Concentration =					Annual Mean Concentration =				4.42		
Bannisdale	1	27-Dec-2006	24-Jan-2007	2.15	Hillsborough Forest	1	04-Dec-2006	03-Jan-2007	3.83		
	2	24-Jan-2007	07-Feb-2007	N		2	03-Jan-2007	22-Jan-2007	3.55		
	3	07-Feb-2007	21-Feb-2007	7.80		3	22-Jan-2007	23-Feb-2007	6.32		
	4	21-Feb-2007	07-Mar-2007	N		4	23-Feb-2007	21-Mar-2007	4.17		
	5	07-Mar-2007	21-Mar-2007	6.52		5	21-Mar-2007	18-Apr-2007	5.98		
	6	21-Mar-2007	03-Apr-2007	N		6	18-Apr-2007	30-Apr-2007	12.29		
	7	03-Apr-2007	17-Apr-2007	7.37		7	30-Apr-2007	13-Jun-2007	*	1.61	
	8	17-Apr-2007	16-May-2007	3.64		8	13-Jun-2007	11-Jul-2007	2.09		
	9	16-May-2007	13-Jun-2007	1.59		9	11-Jul-2007	05-Sep-2007	*	3.27	
	10	13-Jun-2007	11-Jul-2007	1.71		10	05-Sep-2007	19-Sep-2007	4.36		
	11	11-Jul-2007	07-Aug-2007	2.07		11	19-Sep-2007	03-Oct-2007	6.32		
	12	07-Aug-2007	05-Sep-2007	0.94		12	03-Oct-2007	31-Oct-2007	6.44		
	13	05-Sep-2007	03-Oct-2007	1.61		13	31-Oct-2007	28-Nov-2007	5.66		
	14	03-Oct-2007	31-Oct-2007	N		14	28-Nov-2007	24-Dec-2007	9.24		
Annual Mean Concentration =				3.19	Annual Mean Concentration =				4.88		
Lough Navar	1	25-Dec-2006	22-Jan-2007	0.93	Moorhouse	1	27-Dec-2006	21-Feb-2007	*	2.45	
	2	22-Jan-2007	19-Feb-2007	2.59		2	21-Feb-2007	21-Mar-2007	3.22		
	3	19-Feb-2007	20-Mar-2007	1.66		3	21-Mar-2007	17-Apr-2007	2.79		
	4	20-Mar-2007	30-Apr-2007	*		1.53	4	17-Apr-2007	16-May-2007	2.94	
	5	30-Apr-2007	19-May-2007	2.85		5	16-May-2007	13-Jun-2007	2.23		
	6	19-May-2007	11-Jun-2007	0.86		6	13-Jun-2007	11-Jul-2007	2.51		
	7	11-Jun-2007	09-Jul-2007	0.75		7	11-Jul-2007	08-Aug-2007	1.93		
	8	09-Jul-2007	06-Aug-2007	N		8	08-Aug-2007	05-Sep-2007	1.46		
	9	06-Aug-2007	03-Sep-2007	0.71		9	05-Sep-2007	03-Oct-2007	2.51		
	10	03-Sep-2007	01-Oct-2007	0.95		10	03-Oct-2007	31-Oct-2007	4.81		
	11	01-Oct-2007	29-Oct-2007	1.70		11	31-Oct-2007	28-Nov-2007	4.24		
	12	29-Oct-2007	26-Nov-2007	1.36		12	28-Nov-2007	03-Jan-2008	4.41		
	13	26-Nov-2007	16-Jan-2008	*		N	13				
	14						14				
Annual Mean Concentration =				1.43	Annual Mean Concentration =				2.95		

Notes: \* denotes extended sampling period (greater than 40 days). N denotes missing or excluded sample. Annual mean concentration only given if the data capture is greater than 75%.

Nitrogen Dioxide  
Concentration in Air (ppb)

Monthly measurements, collection-day - non standard  
Summary for January 2007 to December 2007

Site	Sampling Period	Start Date	End Date	Concentration (in ppb)	Site	Sampling Period	Start Date/Time	End Date/Time	Concentration (in ppb)
Loch Dee	1	01-Dec-2006	08-Jan-2007	1.69	Redesdale	1	22-Dec-2006	23-Jan-2007	2.31
	2	08-Jan-2007	02-Feb-2007	N		2	23-Jan-2007	20-Feb-2007	4.09
	3	02-Feb-2007	02-Mar-2007	3.15		3	20-Feb-2007	22-Mar-2007	3.65
	4	02-Mar-2007	03-Apr-2007	1.96		4			
	5	03-Apr-2007	01-Jun-2007	*		5			
	6	01-Jun-2007	02-Jul-2007	2.86		6			
	7	02-Jul-2007	22-Aug-2007	*		7			
	8	22-Aug-2007	03-Sep-2007	N		8			
	9	03-Sep-2007	09-Oct-2007	1.62		9			
	10	09-Oct-2007	01-Nov-2007	2.62		10			
	11	01-Nov-2007	01-Dec-2007	1.47		11			
	12					12			
	13					13			
	14					14			
Annual Mean Concentration =				1.76	Annual Mean Concentration =				
Percy's Cross	1	22-Mar-2007	17-Apr-2007	2.81	Whiteadder	1	22-Dec-2006	04-Jan-2007	N
	2	17-Apr-2007	18-May-2007	1.62		2	04-Jan-2007	18-Jan-2007	3.60
	3	18-May-2007	12-Jun-2007	2.52		3	18-Jan-2007	16-Feb-2007	3.92
	4	12-Jun-2007	10-Jul-2007	1.74		4	16-Feb-2007	14-Mar-2007	2.64
	5	10-Jul-2007	07-Aug-2007	1.74		5	14-Mar-2007	24-May-2007	*
	6	07-Aug-2007	04-Sep-2007	1.56		6	24-May-2007	06-Jul-2007	*
	7	04-Sep-2007	02-Oct-2007	2.18		7	06-Jul-2007	11-Oct-2007	*
	8	02-Oct-2007	30-Oct-2007	4.40		8	11-Oct-2007	15-Nov-2007	4.40
	9	30-Oct-2007	27-Nov-2007	3.65		9	15-Nov-2007	10-Jan-2008	*
	10	27-Nov-2007	24-Dec-2007	6.49		10			
	11	24-Dec-2007	24-Jan-2008	5.05		11			
	12					12			
	13					13			
	14					14			
Annual Mean Concentration =				2.90	Annual Mean Concentration =				
Balquhidder 2	1	19-Dec-2006	16-Jan-2007	1.83	Polloch	1	26-Dec-2006	23-Jan-2007	0.58
	2	16-Jan-2007	27-Jan-2007	1.69		2	23-Jan-2007	20-Feb-2007	1.35
	3	27-Jan-2007	19-Feb-2007	2.23		3	20-Feb-2007	20-Mar-2007	1.06
	4	19-Feb-2007	16-Apr-2007	*		4	20-Mar-2007	17-Apr-2007	1.28
	5	16-Apr-2007	21-May-2007	1.77		5	17-Apr-2007	29-May-2007	*
	6	21-May-2007	13-Jun-2007	2.28		6	29-May-2007	12-Jun-2007	1.78
	7	13-Jun-2007	09-Jul-2007	0.87		7	12-Jun-2007	10-Jul-2007	0.78
	8	09-Jul-2007	04-Sep-2007	*		8	10-Jul-2007	07-Aug-2007	2.27
	9	04-Sep-2007	15-Oct-2007	*		9	07-Aug-2007	04-Sep-2007	0.33
	10	15-Oct-2007	29-Oct-2007	4.25		10	04-Sep-2007	02-Oct-2007	0.86
	11	29-Oct-2007	26-Nov-2007	1.10		11	02-Oct-2007	01-Nov-2007	1.18
	12	26-Nov-2007	10-Dec-2007	N		12	01-Nov-2007	27-Nov-2007	0.68
	13	10-Dec-2007	14-Jan-2008	3.06		13	27-Nov-2007	24-Dec-2007	2.40
	14					14	24-Dec-2007	22-Jan-2008	0.72
Annual Mean Concentration =				1.43	Annual Mean Concentration =				

Notes: \* denotes extended sampling period (greater than 40 days). N denotes missing or excluded sample. Annual mean concentration only given if the data capture is greater than 75%.

Nitrogen Dioxide  
Concentration in Air (ppb)

Monthly measurements, collection-day - non standard  
Summary for January 2007 to December 2007

Site	Sampling Period	Start Date	End Date	Concentration (in ppb)	Site	Sampling Period	Start Date/Time	End Date/Time	Concentration (in ppb)
Glensaugh	1	29-Nov-2006	10-Jan-2007	*	Allt a' Mharcaidh	1	28-Dec-2006	22-Jan-2007	0.49
	2	10-Jan-2007	24-Jan-2007	1.40		2	22-Jan-2007	19-Feb-2007	1.24
	3	24-Jan-2007	21-Feb-2007	2.60		3	19-Feb-2007	19-Mar-2007	1.71
	4	21-Feb-2007	20-Mar-2007	3.09		4	19-Mar-2007	16-Apr-2007	0.97
	5	20-Mar-2007	18-Apr-2007	1.65		5	16-Apr-2007	11-Jun-2007	* 0.89
	6	18-Apr-2007	23-May-2007	2.11		6	11-Jun-2007	09-Jul-2007	1.30
	7	23-May-2007	13-Jun-2007	3.42		7	09-Jul-2007	06-Aug-2007	0.66
	8	13-Jun-2007	11-Jul-2007	0.94		8	06-Aug-2007	03-Sep-2007	0.46
	9	11-Jul-2007	08-Aug-2007	1.32		9	03-Sep-2007	01-Oct-2007	0.71
	10	08-Aug-2007	05-Sep-2007	0.68		10	01-Oct-2007	12-Nov-2007	* 0.85
	11	05-Sep-2007	03-Oct-2007	1.93		11	12-Nov-2007	26-Nov-2007	1.86
	12	03-Oct-2007	31-Oct-2007	2.79		12	26-Nov-2007	24-Dec-2007	2.12
	13	31-Oct-2007	28-Nov-2007	1.14		13	24-Dec-2007	21-Jan-2008	1.14
	14	28-Nov-2007	12-Dec-2007	N		14			
Annual Mean Concentration =				2.02	Annual Mean Concentration =				1.06
Strathvaich Dam	1	28-Dec-2006	30-Jan-2007	0.58	Forsinain 2	1	24-Dec-2006	22-Jan-2007	0.38
	2	30-Jan-2007	27-Feb-2007	1.52		2	22-Jan-2007	19-Feb-2007	1.89
	3	27-Feb-2007	26-Mar-2007	0.92		3	19-Feb-2007	21-Mar-2007	1.49
	4	26-Mar-2007	29-Apr-2007	1.04		4	21-Mar-2007	24-Apr-2007	N
	5	29-Apr-2007	03-Jun-2007	1.41		5	24-Apr-2007	20-May-2007	1.89
	6	03-Jun-2007	20-Jun-2007	3.07		6	20-May-2007	04-Jun-2007	4.02
	7	20-Jun-2007	14-Jul-2007	1.04		7	04-Jun-2007	09-Jul-2007	2.20
	8	14-Jul-2007	11-Aug-2007	0.37		8	09-Jul-2007	06-Aug-2007	0.99
	9	11-Aug-2007	12-Sep-2007	0.31		9	06-Aug-2007	03-Sep-2007	0.37
	10	12-Sep-2007	30-Sep-2007	0.69		10	03-Sep-2007	01-Oct-2007	0.78
	11	30-Sep-2007	07-Nov-2007	0.68		11	01-Oct-2007	29-Oct-2007	0.78
	12	07-Nov-2007	24-Nov-2007	0.73		12	29-Oct-2007	25-Nov-2007	1.00
	13	24-Nov-2007	03-Jan-2008	0.87		13	25-Nov-2007	24-Dec-2007	1.67
	14					14	24-Dec-2007	31-Dec-2007	N
Annual Mean Concentration =				0.96	Annual Mean Concentration =				1.39

Notes: \* denotes extended sampling period (greater than 40 days). N denotes missing or excluded sample. Annual mean concentration only given if the data capture is greater than 75%.

**Appendix 4.2 Measurements from triplicate tube sites – concentrations in ppb (Eskdalemuir, Yarner Wood and Harwell)**

Monthly measurements, collection-day - non standard  
Summary for January 2007 to December 2007

**5002 Eskdalemuir**

StartDate	EndDate	Concentration NO2 (ppb)	Period Mean (ppb)
27-Dec-06	24-Jan-07	1.85	
27-Dec-06	24-Jan-07	2.01	1.90
27-Dec-06	24-Jan-07	1.84	
24-Jan-07	21-Feb-07	3.05	
24-Jan-07	21-Feb-07	2.91	2.98
24-Jan-07	21-Feb-07	2.99	
21-Feb-07	21-Mar-07	2.67	
21-Feb-07	21-Mar-07	2.54	2.63
21-Feb-07	21-Mar-07	2.69	
21-Mar-07	18-Apr-07	1.73	
21-Mar-07	18-Apr-07	1.87	1.86
21-Mar-07	18-Apr-07	1.99	
18-Apr-07	18-May-07	1.88	
18-Apr-07	18-May-07	2.44*	1.78
18-Apr-07	18-May-07	1.68	
18-May-07	13-Jun-07	2.64	
18-May-07	13-Jun-07	2.07	2.28
18-May-07	13-Jun-07	2.12	
13-Jun-07	10-Jul-07	1.79	
13-Jun-07	10-Jul-07	0.92	1.37
13-Jun-07	10-Jul-07	1.40	
10-Jul-07	08-Aug-07	1.13	
10-Jul-07	08-Aug-07	0.98	1.01
10-Jul-07	08-Aug-07	0.93	
08-Aug-07	05-Sep-07	1.25	
08-Aug-07	05-Sep-07	1.23	1.20
08-Aug-07	05-Sep-07	1.13	
05-Sep-07	03-Oct-07	2.77*	
05-Sep-07	03-Oct-07	1.66	1.68
05-Sep-07	03-Oct-07	1.70	
03-Oct-07	31-Oct-07	2.83	
03-Oct-07	31-Oct-07	2.67	2.89
03-Oct-07	31-Oct-07	3.18	
31-Oct-07	28-Nov-07	3.28	
31-Oct-07	28-Nov-07	3.03	3.05
31-Oct-07	28-Nov-07	2.83	
28-Nov-07	26-Dec-07	4.02	
28-Nov-07	26-Dec-07	4.00	3.98
28-Nov-07	26-Dec-07	3.92	
26-Dec-07	23-Jan-08	2.58	
26-Dec-07	23-Jan-08	2.23	2.47
26-Dec-07	23-Jan-08	2.61	

Annual mean concentration = 2.21

**5008 Yarner Wood**

StartDate	EndDate	Concentration NO2 (ppb)	Period Mean (ppb)
27-Dec-06	24-Jan-07	1.93	
27-Dec-06	24-Jan-07	1.79	1.85
27-Dec-06	24-Jan-07	1.83	
24-Jan-07	21-Feb-07	6.13	
24-Jan-07	21-Feb-07	6.00	5.90
24-Jan-07	21-Feb-07	5.58	
21-Feb-07	21-Mar-07	1.82	
21-Feb-07	21-Mar-07	1.85	2.05
21-Feb-07	21-Mar-07	2.47	
21-Mar-07	18-Apr-07	4.04	
21-Mar-07	18-Apr-07	4.72	4.20
21-Mar-07	18-Apr-07	3.83	
18-Apr-07	18-May-07	2.92	
18-Apr-07	18-May-07	3.11	3.02
18-Apr-07	18-May-07	3.04	
18-May-07	12-Jun-07	3.11	
18-May-07	12-Jun-07	2.36	2.61
18-May-07	12-Jun-07	2.36	
12-Jun-07	11-Jul-07	1.19	
12-Jun-07	11-Jul-07	1.21	1.18
12-Jun-07	11-Jul-07	1.15	
11-Jul-07	08-Aug-07	1.70	
11-Jul-07	08-Aug-07	1.48	1.58
11-Jul-07	08-Aug-07	1.56	
08-Aug-07	05-Sep-07	1.64	
08-Aug-07	05-Sep-07	1.70	1.67
08-Aug-07	05-Sep-07	0.94*	
05-Sep-07	03-Oct-07	3.73	
05-Sep-07	03-Oct-07	2.55	3.21
05-Sep-07	03-Oct-07	3.35	
03-Oct-07	31-Oct-07	5.60	
03-Oct-07	31-Oct-07	4.74	4.54
03-Oct-07	31-Oct-07	3.29	
31-Oct-07	28-Nov-07	3.17	
31-Oct-07	28-Nov-07	2.69	2.98
31-Oct-07	28-Nov-07	3.09	
28-Nov-07	26-Dec-07	7.62	
28-Nov-07	26-Dec-07	7.45	7.52
28-Nov-07	26-Dec-07	7.49	
26-Dec-07	21-Jan-08	2.39	
26-Dec-07	21-Jan-08	2.78	2.58
26-Dec-07	21-Jan-08	2.56	

Annual mean concentration = 3.26

**5170 Harwell**

StartDate	EndDate	Concentration NO2 (ppb)	Period Mean (ppb)
01-Jan-07	09-Jan-07	-999	-999
09-Jan-07	22-Jan-07	2.49	
09-Jan-07	22-Jan-07	2.69	2.59
09-Jan-07	22-Jan-07	-999	
22-Jan-07	22-Feb-07	12.32	
22-Jan-07	22-Feb-07	11.62	11.49
22-Jan-07	22-Feb-07	10.53	
22-Feb-07	21-Mar-07	5.85	
22-Feb-07	21-Mar-07	5.89	5.45
22-Feb-07	21-Mar-07	4.62	
21-Mar-07	17-Apr-07	9.44	
21-Mar-07	17-Apr-07	10.66	9.84
21-Mar-07	17-Apr-07	9.42	
17-Apr-07	18-May-07	7.14	
17-Apr-07	18-May-07	4.76	5.87
17-Apr-07	18-May-07	5.70	
18-May-07	12-Jun-07	6.35	
18-May-07	12-Jun-07	6.79	6.61
18-May-07	12-Jun-07	6.68	
12-Jun-07	09-Jul-07	6.37	
12-Jun-07	09-Jul-07	5.94	6.16
12-Jun-07	09-Jul-07	6.17	
09-Jul-07	06-Aug-07	0.33	
09-Jul-07	06-Aug-07	0.56	-999
09-Jul-07	06-Aug-07	0.39	
06-Aug-07	02-Sep-07	5.49	
06-Aug-07	02-Sep-07	5.68	5.58
06-Aug-07	02-Sep-07	5.57	
02-Sep-07	01-Oct-07	9.51*	
02-Sep-07	01-Oct-07	13.17	13.14
02-Sep-07	01-Oct-07	13.11	
01-Oct-07	03-Dec-07		
01-Oct-07	03-Dec-07		-999
01-Oct-07	03-Dec-07		
03-Dec-07	02-Jan-08	18.67	
03-Dec-07	02-Jan-08	18.68	18.07
03-Dec-07	02-Jan-08	16.87	

Annual mean concentration = -999

\* Outlier - not included in period / annual mean calculation  
-999 denotes no sample obtained / concentration not accepted

**Appendix 4.3 Time Series of Historic Nitrogen Dioxide Annual Mean Concentrations (ppb) for the years 1987 – 2007**

Site	Site Code	Easting	Northing	1987	1988	1989	1990	1991	1992	1993	1994	1995	1996	1997	1998	1999	2000	2001	2002	2003	2004	2005	2006	2007
Eskdalemuir	5002	3235	6030	3.37	2.87	2.86	2.36	3.72	2.68	2.88	3.1	2.3	2.6	2.0	1.6	2.01	2.17	2.32	2.11	2.41	1.53	2.50	1.96	2.21
Goonhilly	5003	1723	214	3.61	2.82	4.66	4.03	4.92	4.06	-999	4.1	-999	4.6	3.2	1.9	-999	2.20	3.61	2.70	4.32	2.07	-999	2.97	-999
Stoke Ferry	5004	5700	2988	13.14	13.54	14.31	11.49	12.60	12.42	10.24	11.1	9.5	9.3	7.6	7.5	9.38	9.52	8.29	8.36	8.22	7.25	7.21	closed	
Ludlow	5005	3570	2741	12.05	9.33	8.05	closed																	
Lough Navar	5006	192	5212	1.77	1.53	1.62	1.27	1.98	1.48	1.51	1.6	1.4	1.6	1.2	0.8	1.61	1.25	1.78	1.46	2.43	0.97	1.36	1.40	1.43
Barcombe Mills	5007	5437	1149	12.13	10.66	11.90	10.34	11.00	9.29	9.29	8.7	8.8	10.4	7.3	6.1	6.13	7.10	7.01	6.14	6.43	5.75	6.97	5.64	5.17
Yarner Wood	5008	2786	789	5.24	4.06	5.83	4.16	5.18	4.27	3.89	3.6	3.5	4.7	3.5	2.2	2.64	2.58	3.69	3.60	4.11	2.51	3.40	2.91	3.26
High Muffles	5009	4776	4939	7.42	8.53	9.00	8.10	8.94	6.73	6.08	7.4	6.2	5.7	5.5	4.6	4.87	4.99	4.87	5.13	5.64	3.85	4.73	4.57	4.42
Strathvaich Dam	5010	2347	8750	1.22	0.88	0.74	0.57	1.10	0.74	0.88	0.9	0.6	0.6	0.4	0.1	0.56	0.54	0.76	0.96	0.93	0.39	0.68	0.52	0.96
Glen Dye	5011	3642	7864	2.77	2.18	2.72	2.46	3.46	2.32	2.40	2.6	1.7	2.5	1.8	1.2	1.47	1.82	1.91	1.92	2.00	0.96	1.64	closed	
Preston Montford	5023	3432	3143	10.42	9.51	10.24	8.40	7.85	7.28	6.81	8.48	7.6	8.0	5.8	4.9	-999	4.14	7.73	8.02	7.51	3.88	5.13	closed	
Flatford Mill	5024	6077	2333	15.14	13.61	-999	-999	9.85	9.92	7.78	11.4	9.2	9.8	9.0	7.9	8.72	8.81	8.75	8.14	8.19	7.25	-999	7.21	7.03
River Mharcaidh	5103	2876	8052	2.37	1.48	-999	-999	1.23	1.29	1.40	1.34	1.0	1.0	0.7	0.5	-999	0.82	1.08	1.06	1.16	0.71	1.16	0.77	1.06
Whiteadder	5106	3664	6633									2.4	2.9	2.2	2.0	2.73	2.97	2.82	2.99	2.98	2.16	2.33	-999	-999
Loch Dee	5107	2468	5779	3.77	2.99	3.39	2.80	2.18	2.22	2.97	3.93	2.4	2.0	2.1	1.4	1.93	1.75	2.23	2.31	2.69	1.39	-999	1.33	1.76
Redesdale	5109	3833	5954									3.6	3.9	3.5	2.3	3.10	3.07	3.06	3.66	3.60	2.08	2.86	2.89	closed
Bannisdale	5111	3515	5043	6.47	7.24	6.92	5.76	5.63	4.96	4.74	5.37	5.0	5.0	-999	3.3	4.09	3.75	4.61	3.78	3.80	2.96	2.94	3.17	3.19
Cow Green Reservoir	5113	3817	5298	6.56	6.28	6.18	5.32	4.51	4.06	5.04	4.02	5.0	3.2	3.8	-999	-999	4.14	3.20	4.08	4.06	2.55	3.22	closed	
Thorganby	5117	4676	4428	13.93	14.57	16.39	13.61	12.97	11.04	11.15	11.52	9.7	9.0	8.3	7.6	8.10	9.56	8.57	7.84	8.82	6.89	7.72	closed	
Jenny Hurn	5118	4816	3986	15.77	16.19	18.84	16.57	14.03	12.63	10.82	12.22	11.4	10.8	9.4	9.7	10.02	10.66	10.35	closed					
Beddgelert	5119	2556	3518	4.96	3.78	4.01	3.31	3.17	2.97	1.91	4.0	-999	closed											
Wardlow Hay Cop	5120	4177	3739	15.02	14.60	14.18	12.26	11.17	10.43	10.67	11.3	11.0	9.7	9.2	7.5	7.66	7.23	8.36	9.14	8.56	6.70	7.16	closed	
Bottesford	5121	4797	3376	16.04	15.56	15.93	14.13	11.41	11.15	10.11	10.0	10.5	10.5	9.2	7.9	8.19	7.95	9.31	7.92	8.92	7.65	8.13	closed	
Plynlimon	5122	2822	2841	6.29	4.30	closed																		
Tycanol Wood	5123	2093	2364	5.96	4.09	5.16	3.51	3.85	3.11	3.43	3.68	3.0	3.6	2.9	1.8	-999	2.08	2.43	2.93	3.07	1.56	2.31	1.95	2.85
Llyn Brianne	5124	2807	2492	6.26	4.90	-999	-999	5.12	3.75	4.86	3.36	-999	-999	2.2	-999	2.06	2.23	0.00	3.55	3.54	2.01	-999	closed	
Woburn	5127	4964	2361	18.68	19.35	-999	-999	16.96	15.47	13.26	14.41	13.2	14.2	12.3	11.0	11.43	11.23	12.84	12.50	12.34	9.46	11.24	closed	
Compton	5129	4512	1804	15.56	14.44	15.45	13.91	13.02	13.04	11.36	11.87	11.6	9.7	9.5	7.8	7.98	8.39	10.06	9.41	9.52	6.01	7.13	7.41	closed
Driby	5136	5386	3744	11.84	13.09	12.84	11.08	12.71	8.56	8.21	9.03	6.8	7.9	6.4	6.4	6.71	7.08	7.52	6.49	6.87	5.10	5.24	5.27	-999
Achanarras	5140	3151	9550	2.91	1.88	2.49	1.95	1.42	0.96	1.68	1.95	1.3	1.3	1.2	0.8	0.90	1.14	1.34	1.43	1.52	0.84	1.34	closed	
Hillsborough Forest	5149	1349	5156									5.8	5.3	4.5	3.2	3.77	4.08	5.48	4.88	6.04	4.10	4.63	3.81	4.88
Pumulumon	5150	2823	2854			-999	-999	3.62	3.35	3.60	3.43	3.0	3.7	2.2	1.7	2.16	1.93	2.82	2.88	3.19	1.71	2.16	2.17	2.77
Polloch	5151	1792	7689									0.8	0.9	0.6	0.2	0.64	0.40	0.68	0.78	1.02	0.45	0.80	0.64	1.14
Balquhiddier 2	5152	2545	7207								2.3	2.3	-999	2.5	1.4	-999	1.53	1.67	1.88	2.05	1.13	1.59	1.26	1.43
Llyn Llydaw	5153	2638	3549										-999	-999	-999	1.91	1.77	2.14	2.57	2.60	1.22	-999	-999	1.97
Balquhiddier	5200	2521	7206	3.34	2.91	3.61	2.33	2.50	1.64	1.85	2.3	closed												
Forsinard	5332	2890	9425									1.2	1.4	0.9	0.4	-999	0.98	1.27	1.12	1.31	0.56	1.02	closed	
Glensaugh	5164	3602	7967																				1.72	2.02
Forsinain 2	5166	2906	9486																				0.98	1.39
Moorhouse	5167	3758	5328																				-999	2.95
Percy's Cross	5168	3880	5935																					2.90
Harwell	5170	4468	1860																					-999

Notes:

(1) -999 indicates insufficient data capture to give a valid annual mean

Notes for 2007:

(1) Compton and Redesdale diffusion tubes were moved to Harwell (triplicate) and Percy's Cross respectively in early 2007



## Appendix 5

### Nitric Acid Denuder Measurements 2007

Tables A5.1 and A5.2 below show the 12 original denuder sites and locations, and the 18 new sites that were added to the Nitric Acid Denuder Network in 2006.

Tables A5.3a – A5.3i provide the measurements and the summary statistics of the monthly concentrations of  $\text{HNO}_3$ ,  $\text{SO}_2$  and  $\text{HCl}$  in the gas phase, and of  $\text{NO}_3^-$ ,  $\text{SO}_4^{2-}$ ,  $\text{Cl}^-$ ,  $\text{Na}^+$ ,  $\text{Mg}^{2+}$  and  $\text{Ca}^{2+}$  in the aerosol phase.

Appendix A5.4 shows monthly measurements of gaseous  $\text{SO}_2$  and aerosol  $\text{SO}_4^{2-}$  made in the Nitric Acid Monitoring Network between September 1999 and December 2007.

<b>Table A5.1 Original 12 Denuder Sites</b>		
Site code	Site name	OS Grid Ref
1	Bush OTC	NT243642
21	Glensaugh	NO664789
24	Rothamsted	TL123129
30	Strathvaich Dam	NH348750
31	Eskdalemuir	NT235030
32	High Muffles	SE776939
33	Stoke Ferry	TL700988
34	Yarner Wood	SX789788
40	Sutton Bonington	SK505268
45	Lough Navar	IH065545
70	Cwmystwyth	SN771742
83	Barcombe Mills	TQ438149

<b>Table A5.2 New (2006-) Denuder Sites</b>		
Site code	Site name	OS Grid Ref
6B	Rosemaund	SO564476
8C	Narberth	SN146127
12	Halladale	NC902488
18	Auchencorth Moss	NT221562
19	Shetland	HU500400
22	Moor House	NY751334
36C	Cromwell Rd	TQ266791
41	Lagganlia	NH856037
44	Hillsborough	IJ243577
47	Rum	NM408992
60C	Edinburgh St Leonards	NT262731
77	Carradale	NR798378
97	Detling	TQ801597
98	Harwell	SU474863
99	Ladybower	SK164892
100	Plas Y Brenin	SH716578
102	Caenby	SK993900
103	Goonhilly	SW723214



**Table A5.3a Monthly Nitric Acid Measurements from the 30 monitoring sites in the HNO<sub>3</sub> Monitoring Network (Gaseous HNO<sub>3</sub> (µg HNO<sub>3</sub> m<sup>-3</sup>))**

Month	Site 1	Site 21	Site 24	Site 30	Site 31	Site 32	Site 33	Site 34	Site 83	Site 40	Site 45	Site 70	Site 6B	Site 8C	Site 12
Jan-07	0.25	0.12	0.85	0.16	0.11	0.37	0.77	0.26	0.58	0.93	0.10	0.20	0.31	0.28	0.08
Feb-07	0.61	0.61	ND <sup>1</sup>	0.22	<b>0.16</b>	1.03	1.43	0.74	1.10	2.06	ND <sup>1</sup>	0.55	0.87	0.65	0.38
Mar-07	0.49	0.34	1.57	0.09	0.32	0.83	1.28	0.43	0.92	1.55	0.18	0.40	0.75	0.44	0.05 <sup>2</sup>
Apr-07	0.62	0.67	1.95	0.44	<b>0.93</b>	0.72	1.33	1.42	1.93	1.77	0.45	1.01	1.20	1.18	0.31
May-07	0.67	0.51	0.97	0.24	0.23	0.48	0.91	0.66	1.00	0.84	0.21	0.36	0.66	0.47	0.16 <sup>2</sup>
Jun-07	0.91	0.78	1.06	0.34	0.55	0.76	1.04	0.92	1.44	0.92	0.46	0.70	1.47	0.43 <sup>3</sup>	0.33
Jul-07	0.41	0.26	1.06	0.16	0.21	0.50	1.19	0.27	0.66	0.94	0.10	0.19	0.34	0.43 <sup>3</sup>	0.15
Aug-07	0.37	0.16	1.70	0.10	0.13 <sup>2</sup>	0.35	0.86	0.52	1.09	1.46	0.05	0.21	0.58	ND <sup>7</sup>	0.07 <sup>2</sup>
Sep-07	0.30	0.14	1.43	0.04	0.17	0.38	0.98	0.57	1.00 <sup>2</sup>	1.39	0.06	0.33	0.51	0.39	0.08
Oct-07	0.77	0.73	2.18	0.35	0.66	1.03	1.28	1.18	1.23 <sup>2</sup>	1.98	0.38	0.72	1.12	0.84	0.18
Nov-07	0.48	<b>0.18</b>	2.00	0.12	ND <sup>1</sup>	0.68	1.35	0.44	1.16 <sup>2</sup>	2.02	0.20	0.32	0.67	0.44	ND <sup>4</sup>
Dec-07	0.79	0.74 <sup>2</sup>	2.20	0.16	0.48 <sup>2</sup>	1.08	1.37	0.89	ND <sup>1</sup>	1.87	0.50	0.71	0.92	0.98	0.28
Mean	0.56	0.44	1.54	0.20	0.36	0.68	1.15	0.69	1.10	1.48	0.24	0.47	0.78	0.59	0.19
Min	0.25	0.12	0.85	0.04	0.11	0.35	0.77	0.26	0.58	0.84	0.05	0.19	0.31	0.28	0.05
Max	0.91	0.78	2.20	0.44	0.93	1.08	1.43	1.42	1.93	2.06	0.50	1.01	1.47	1.18	0.38
SD	0.21	0.26	0.51	0.12	0.26	0.27	0.22	0.36	0.37	0.47	0.17	0.26	0.35	0.28	0.12
CV (%)	37.3	60.0	32.7	60.5	74.0	39.4	19.6	51.6	33.3	31.8	70.4	54.9	44.7	47.7	62.6
N	12	12	11	12	11	12	12	12	11	12	11	12	12	11	11

Month	Site 18	Site 19	Site 22	Site 36	Site 41	Site 44	Site 47	Site 60	Site 77	Site 97	Site 98	Site 99	Site 100	Site 102	Site 103
Jan-07	0.17	0.09	0.39 <sup>2</sup>	2.88	<b>0.09</b> <sup>2</sup>	0.23	<b>0.09</b>	1.24	0.19	1.45	0.49	0.40	0.12	0.93	0.33 <sup>2,3</sup>
Feb-07	0.41	0.35	0.76 <sup>2</sup>	4.51	ND <sup>1</sup>	0.56	0.69 <sup>2</sup>	2.32	0.23	2.49	1.38	1.26	ND <sup>1</sup>	1.77	0.33 <sup>2,3</sup>
Mar-07	0.39	0.31	0.40	4.75	<b>0.33</b>	0.53 <sup>2</sup>	0.19	1.48	0.14	2.44	0.98	0.71	0.35	1.31	0.62
Apr-07	0.57	0.26	1.94	4.72	0.36	0.52	0.10	<b>2.62</b>	0.51	2.73	1.51	lost	1.14	ND <sup>1</sup>	1.68
May-07	0.36	0.13	0.37 <sup>2</sup>	3.22	0.28	0.28	0.11	1.28	0.41	2.20	0.81	0.74	0.45	0.87	0.28
Jun-07	1.05	0.41	1.12	3.56	0.21	0.44	0.13	1.59	0.53	1.31	1.23	1.24	0.53	1.03	0.94
Jul-07	0.27	0.32	0.60	3.55	0.11	0.33	<b>0.21</b>	1.22	0.29	1.21	0.84	0.82	0.25	0.88	0.34
Aug-07	0.22	0.16	1.25	3.17	0.11	0.22	0.03 <sup>2</sup>	1.30	0.20	1.68	0.93	0.59	0.25	0.93	0.41
Sep-07	0.17	ND <sup>6</sup>	ND <sup>1</sup>	3.02	0.12	0.29	0.15	0.88	0.11	1.59	0.87	0.67	0.22	ND <sup>4</sup>	0.77
Oct-07	0.55	0.41	0.13	3.58	0.43	0.55	2.43	0.27	1.62	2.67	0.50	2.39	0.14	1.02	1.02
Nov-07	0.37	<b>0.06</b>	0.36	2.73	0.12	0.36	0.11	1.55	0.25	2.27	0.83	0.60	0.49	1.67	0.60 <sup>2</sup>
Dec-07	0.47	0.69	0.92	4.41	0.46	0.63	ND <sup>1</sup>	2.70	0.21	2.23	1.47	1.71	0.53	1.29	0.59
Mean	0.42	0.29	0.75	3.67	0.24	0.41	0.39	1.54	0.39	2.02	0.99	1.01	0.41	1.07	0.66
Min	0.17	0.06	0.13	2.73	0.09	0.22	0.03	0.27	0.11	1.21	0.49	0.40	0.12	0.02	0.28
Max	1.05	0.69	1.94	4.75	0.46	0.63	2.43	2.70	1.62	2.73	1.51	2.39	1.14	1.77	1.68
SD	0.24	0.18	0.53	0.73	0.14	0.14	0.70	0.71	0.41	0.54	0.34	0.59	0.29	0.47	0.40
CV (%)	57.8	62.1	70.6	20.0	59.3	34.9	182.1	46.0	104.9	26.9	34.9	58.7	70.4	43.9	61.2
N	12	11	11	12	11	12	11	12	12	12	12	11	11	11	12

Notes:

ND<sup>1</sup>: Power off during sampling period

Data<sup>2</sup> = Flow < 0.2 l/min (pump not working properly, or intermittent power cuts)

Data<sup>3</sup> = Samples exposed for more than one month

ND<sup>4</sup> = Samples lost / damaged

ND<sup>5</sup> = Problems with aerosol sampling

ND<sup>6</sup> = Water in sampling train, or leak in system

ND<sup>7</sup> = Possible contamination because sampling train returned separated

0.0<sup>8</sup> = < limit of detection: lower than blanks

NS = Measurement not Started

**Numbers in bold:** Capture = < 75% in the first of the 2 glass denuders

**Table A5.3b Monthly Sulphur Dioxide data at the 30 monitoring sites in the HNO<sub>3</sub> Monitoring Network (Gaseous SO<sub>2</sub> (µg SO<sub>2</sub> m<sup>-3</sup>))**

Month	Site 1	Site 21	Site 24	Site 30	Site 31	Site 32	Site 33	Site 34	Site 83	Site 40	Site 45	Site 70	Site 6B	Site 8C	Site 12
Jan-07	0.25	0.39	1.53	0.69	<b>0.74</b>	1.33	1.82	0.73	1.54	2.65	0.52	0.91	0.85	1.16	<b>0.61</b>
Feb-07	1.39	1.04	ND <sup>1</sup>	0.47	0.41	2.36	2.28	1.32	2.02	2.69	ND <sup>1</sup>	1.31	1.16	1.34	<b>0.71</b>
Mar-07	1.45	0.62	1.98	<b>0.30</b>	0.53	1.26	1.83	0.74	1.58	2.54	0.36	0.79	1.21	0.85	<b>0.60</b> <sup>2</sup>
Apr-07	1.36	0.89	2.03	0.42	0.57	1.76	1.52	1.48	3.20	1.60	0.58	1.35	1.61	1.42	<b>0.36</b>
May-07	3.26	0.57	0.94	0.17	0.33	0.79	0.85	0.57	1.18	1.29	0.18	0.49	0.58	0.97	0.28 <sup>2</sup>
Jun-07	2.72	0.53	1.13	<b>0.27</b>	0.42	0.89	0.84	0.68	2.00	1.17	0.32	0.65	0.96	0.54 <sup>3</sup>	<b>0.36</b>
Jul-07	0.67	0.23	1.05	0.02	0.13	0.84	1.22	0.15	0.71	0.84	0.08	0.16	0.18	0.54 <sup>3</sup>	0.10
Aug-07	1.01	0.30	1.38	0.07	0.29 <sup>2</sup>	0.70	1.03	0.57	0.95	8.55	0.08	0.15	0.38	ND <sup>7</sup>	<b>0.10</b> <sup>2</sup>
Sep-07	0.54	0.12	1.24	<b>0.05</b>	0.18	0.87	1.03	0.36	0.64 <sup>2</sup>	0.57	0.12	0.30	0.49	0.28	0.06
Oct-07	0.79	1.25	1.70	0.21	0.66	1.84	1.44	0.91	1.01 <sup>2</sup>	1.85	0.30	0.87	0.95	1.31	0.13
Nov-07	0.86	0.03	1.94	0.03	ND <sup>1</sup>	1.68	1.97	0.42	1.17 <sup>2</sup>	2.45	0.23	<b>0.52</b>	0.51	0.63	ND <sup>4</sup>
Dec-07	0.85	1.24 <sup>2</sup>	2.19	0.08	0.35 <sup>2</sup>	1.78	1.28	1.00	ND <sup>1</sup>	1.98	0.33	1.03	0.78	1.75	0.09
Mean	1.26	0.60	1.56	0.23	0.42	1.34	1.43	0.74	1.45	2.35	0.28	0.71	0.81	0.98	0.31
Min	0.25	0.03	0.94	0.02	0.13	0.70	0.84	0.15	0.64	0.57	0.08	0.15	0.18	0.28	0.06
Max	3.26	1.25	2.19	0.69	0.74	2.36	2.28	1.48	3.20	8.55	0.58	1.35	1.61	1.75	0.71
SD	0.89	0.42	0.44	0.21	0.19	0.53	0.47	0.39	0.74	2.08	0.17	0.41	0.40	0.46	0.24
CV (%)	70.5	70.0	28.2	89.5	46.0	39.9	32.8	51.8	51.0	88.6	58.7	56.9	49.9	46.5	77.1
N	12	12	11	12	11	12	12	12	11	12	11	12	12	11	11

Month	Site 18	Site 19	Site 22	Site 36	Site 41	Site 44	Site 47	Site 60	Site 77	Site 97	Site 98	Site 99	Site 100	Site 102	Site 103
Jan-07	<b>0.61</b>	0.74	0.71 <sup>2</sup>	1.92	0.34 <sup>2</sup>	0.89	<b>0.54</b>	1.07	<b>0.65</b>	2.01	1.33	1.28	1.72	2.48	0.91 <sup>2,3</sup>
Feb-07	0.88	<b>0.81</b>	2.13 <sup>2</sup>	3.96	ND <sup>1</sup>	1.13	<b>2.44</b> <sup>2</sup>	2.65	<b>0.65</b>	4.91	2.31	2.50	ND <sup>1</sup>	2.98	0.91 <sup>2,3</sup>
Mar-07	0.84	0.70	1.00	2.15	0.41	1.64 <sup>2</sup>	0.25	1.85	<b>0.28</b>	2.89	1.90	1.93	1.78	2.48	0.96
Apr-07	1.60	0.58	1.54	3.25	0.45	0.85	<b>0.50</b>	3.64	0.58	1.59	2.61	lost	3.67	ND <sup>1</sup>	1.74
May-07	1.07	0.79	0.56 <sup>2</sup>	1.24	0.38	<b>0.29</b>	0.14	3.86	0.50	0.90	1.54	1.39	1.41	1.55	0.46
Jun-07	2.50	1.79	0.84	2.07	<b>0.28</b>	0.60	0.25	4.35	0.62	2.06	1.46	1.52	0.84	1.67	0.75
Jul-07	0.49	0.93	0.29	1.70	0.05	0.35	0.11	1.81	0.05	1.45	0.69	0.92	0.74	1.58	0.54
Aug-07	0.64	0.62	1.24	1.87	0.10	0.33	0.05 <sup>2</sup>	1.93	<b>0.13</b>	2.66	1.15	0.65	0.64	1.85	0.51
Sep-07	0.44	ND <sup>6</sup>	ND <sup>1</sup>	1.81	0.11	0.32	0.11	0.71	<b>0.08</b>	2.50	1.01	1.11	0.55	ND <sup>4</sup>	0.70
Oct-07	0.71	0.97	<b>0.19</b>	2.08	0.34	0.53	1.79	0.26	2.27	3.24	0.91	5.30	0.24	1.28	0.82
Nov-07	0.44	<b>0.22</b>	0.51	2.17	0.09	0.46	<b>0.31</b>	1.46	0.14	3.64	0.79	1.11	1.45	2.14	0.58 <sup>2</sup>
Dec-07	0.52	0.64	1.41	3.79	0.25	0.62	ND <sup>1</sup>	2.54	0.03	3.88	1.77	3.38	1.02	1.29	0.50
Mean	0.89	0.80	0.95	2.33	0.26	0.67	0.59	2.18	0.50	2.65	1.46	1.92	1.28	1.77	0.78
Min	0.44	0.22	0.19	1.24	0.05	0.29	0.05	0.26	0.03	0.90	0.69	0.65	0.24	0.14	0.46
Max	2.50	1.79	2.13	3.96	0.45	1.64	2.44	4.35	2.27	4.91	2.61	5.30	3.67	2.98	1.74
SD	0.60	0.38	0.59	0.86	0.14	0.40	0.78	1.28	0.61	1.14	0.60	1.37	0.94	0.76	0.35
CV (%)	67.3	48.1	62.1	36.7	56.4	60.6	132.9	58.7	122.6	43.2	41.5	71.4	73.3	43.2	44.9
N	12	11	11	12	11	12	11	12	12	12	12	11	11	11	12

## Notes:

ND<sup>1</sup>: Power off during sampling periodData<sup>2</sup> = Flow < 0.2 l/min (pump not working properly, or intermittent power cuts)Data<sup>3</sup> = Samples exposed for more than one monthND<sup>4</sup> = Samples lost / damagedND<sup>5</sup> = Problems with aerosol samplingND<sup>6</sup> = Water in sampling train, or leak in systemND<sup>7</sup> = Possible contamination because sampling train returned separated0.0<sup>8</sup> = < limit of detection: lower than blanks

NS = Measurement not Started

**Numbers in bold:** Capture = < 75% in the first of the 2 glass denuders

**Table A5.3c Monthly Hydrochloric Acid data at the 30 monitoring sites in the HNO<sub>3</sub> Monitoring Network (Gaseous HCl (µg m<sup>-3</sup>))**

Month	Site 1	Site 21	Site 24	Site 30	Site 31	Site 32	Site 33	Site 34	Site 83	Site 40	Site 45	Site 70	Site 6B	Site 8C	Site 12
Jan-07	0.36	0.27	<b>0.62</b>	<b>0.29</b>	<b>0.36</b>	0.23	0.38	<b>0.57</b>	<b>0.66</b>	<b>0.54</b>	0.16	0.75	<b>0.61</b>	<b>0.60</b>	0.27
Feb-07	0.29	0.41	ND <sup>1</sup>	0.25	<b>0.13</b>	0.36	0.46	0.38	0.45	0.32	ND <sup>1</sup>	0.28	0.28	0.40	<b>0.67</b>
Mar-07	0.26	0.27	0.36	0.19	0.26	0.36	0.44	0.32	0.43	0.24	0.15	0.27	0.31	0.49	0.36 <sup>2</sup>
Apr-07	0.27	0.31	0.41	0.33	0.22	0.31	0.42	0.44	0.49	0.36	0.18	0.35	0.43	0.48	0.26
May-07	0.21	0.17	0.28	0.18	0.12	0.25	0.27	0.30	0.52	0.30	0.10	0.19	0.34	0.32	0.18 <sup>2</sup>
Jun-07	0.32	0.30	0.33	0.21	0.16	<b>0.40</b>	0.26	0.32	0.45	0.42	0.10	0.25	0.40	0.27 <sup>3</sup>	0.21
Jul-07	0.23	0.13	0.29	0.16	0.13	0.20	0.30	0.30	0.46	0.43	0.08	0.21	0.21	0.27 <sup>3</sup>	0.15
Aug-07	0.12	0.17	0.30	0.12	0.08 <sup>2</sup>	0.16	0.27	0.21	0.33	0.36	0.06	0.16	0.22	ND <sup>7</sup>	0.21 <sup>2</sup>
Sep-07	0.16	0.18	0.27	<b>0.17</b>	0.14	0.17	0.27	0.19	0.36 <sup>2</sup>	0.30	0.07	0.16	0.18	<b>0.19</b>	0.15
Oct-07	0.27	0.25	0.34	0.27	0.21	0.24	0.25	0.27	0.26 <sup>2</sup>	0.28	0.12	0.21	0.21	0.24	0.11
Nov-07	0.26	<b>0.11</b>	0.33	0.23	ND <sup>1</sup>	0.28	0.31	0.26	0.43 <sup>2</sup>	0.32	0.12	0.17	0.17	0.29	ND <sup>4</sup>
Dec-07	0.31	0.42 <sup>2</sup>	0.34	0.20	0.26 <sup>2</sup>	0.32	0.36	0.36	ND <sup>1</sup>	0.32	0.22	0.33	0.26	<b>0.48</b>	0.23
Mean	0.25	0.25	0.35	0.22	0.19	0.27	0.33	0.32	0.44	0.35	0.12	0.28	0.30	0.37	0.26
Min	0.12	0.11	0.27	0.12	0.08	0.16	0.25	0.19	0.26	0.24	0.06	0.16	0.17	0.19	0.11
Max	0.36	0.42	0.62	0.33	0.36	0.40	0.46	0.57	0.66	0.54	0.22	0.75	0.61	0.60	0.67
SD	0.07	0.10	0.10	0.06	0.08	0.08	0.08	0.10	0.11	0.08	0.05	0.16	0.13	0.13	0.15
CV (%)	25.9	40.8	27.5	27.7	44.0	28.5	23.0	31.6	24.1	23.0	41.1	57.8	42.5	35.7	60.3
N	12	12	11	12	11	12	12	12	11	12	11	12	12	11	11

Month	Site 18	Site 19	Site 22	Site 36	Site 41	Site 44	Site 47	Site 60	Site 77	Site 97	Site 98	Site 99	Site 100	Site 102	Site 103
Jan-07	<b>0.31</b>	<b>0.53</b>	0.75 <sup>2</sup>	<b>0.40</b>	0.26 <sup>2</sup>	0.20	0.24	<b>0.46</b>	<b>0.35</b>	0.95	0.26	0.40	0.21	<b>0.73</b>	0.73 <sup>2,3</sup>
Feb-07	0.14	0.49	0.47 <sup>2</sup>	0.47	ND <sup>1</sup>	0.24	0.58 <sup>2</sup>	0.32	0.20	0.51	0.33	0.43	ND <sup>1</sup>	0.36	0.73 <sup>2,3</sup>
Mar-07	0.20	0.75	0.40	0.45	<b>0.27</b>	0.28 <sup>2</sup>	0.21	0.44	0.14	0.39	0.34	0.45	0.33	0.45	0.51
Apr-07	0.27	0.42	1.72	0.56	0.15	0.22	0.25	<b>1.37</b>	0.40	0.17	0.39	ND <sup>4</sup>	0.47	ND <sup>1</sup>	0.70
May-07	0.19	0.26	0.20 <sup>2</sup>	0.34	<b>0.19</b>	0.16	0.12	0.39	0.41	0.20	0.29	0.41	0.26	0.34	0.39
Jun-07	0.34	0.66	0.18	0.38	0.08	0.20	0.07	0.47	0.40	0.30	0.22	0.31	0.29	0.36	0.56
Jul-07	0.16	0.65	0.33	0.39	0.05	0.18	<b>0.23</b>	0.25	0.30	0.35	0.23	0.34	0.21	0.30	0.46
Aug-07	0.11	0.31	0.30	0.34	0.08	0.09	0.03 <sup>2</sup>	0.15	0.15	0.42	0.18	0.18	0.18	0.26	0.38
Sep-07	0.11	ND <sup>6</sup>	ND <sup>1</sup>	0.28	0.08	0.12	0.13	0.18	0.13	0.43	0.23	0.25	0.21	ND <sup>4</sup>	0.64
Oct-07	0.24	0.90	0.07	0.21	0.18	0.21	0.28	0.13	0.37	0.47	0.12	0.89	0.18	<b>0.14</b>	0.61
Nov-07	0.20	0.61	0.17	0.26	<b>0.17</b>	0.20	0.19	0.25	0.16	0.46	0.20	0.35	0.22	0.30	0.61 <sup>2</sup>
Dec-07	0.20	1.23	0.38	0.24	0.23	0.37	ND <sup>1</sup>	0.34	0.13	0.68	0.28	2.52	0.18	0.30	0.49
Mean	0.21	0.62	0.45	0.36	0.16	0.21	0.21	0.40	0.26	0.44	0.26	0.59	0.25	0.32	0.57
Min	0.11	0.26	0.07	0.21	0.05	0.09	0.03	0.13	0.13	0.17	0.12	0.18	0.18	0.02	0.38
Max	0.34	1.23	1.72	0.56	0.27	0.37	0.58	1.37	0.41	0.95	0.39	2.52	0.47	0.73	0.73
SD	0.07	0.28	0.46	0.10	0.08	0.07	0.14	0.33	0.12	0.21	0.07	0.66	0.09	0.18	0.12
CV (%)	36.2	44.6	101.6	28.8	48.2	35.0	67.8	83.4	45.6	47.1	29.0	111.9	35.7	55.3	21.9
N	12	11	11	12	11	12	11	12	12	12	12	11	11	11	12

Notes:

ND<sup>1</sup>: Power off during sampling period

Data<sup>2</sup> = Flow < 0.2 l /min (pump not working properly, or intermittent power cuts)

Data<sup>3</sup> = Samples exposed for more than one month

ND<sup>4</sup> = Samples lost / damaged

ND<sup>5</sup> = Problems with aerosol sampling

ND<sup>6</sup> = Water in sampling train, or leak in system

ND<sup>7</sup> = Possible contamination because sampling train returned separated

0.0<sup>8</sup> = < limit of detection: lower than blanks

NS = Measurement not Started

Numbers in bold: Capture = < 75% in the first of the 2 glass denuders

**Table A5.3d Monthly Aerosol Nitrate data at the 30 monitoring sites in the HNO<sub>3</sub> Monitoring Network (Particulate NO<sub>3</sub><sup>-</sup> (µg m<sup>-3</sup>))**

Month	Site 1	Site 21	Site 24	Site 30	Site 31	Site 32	Site 33	Site 34	Site 83	Site 40	Site 45	Site 70	Site 6B	Site 8C	Site 12
Jan-07	0.23	0.16	1.33	0.07	0.61	0.59	0.96	0.60	0.82	1.46	0.24	0.39	0.49	0.50	0.08
Feb-07	1.00	0.27	ND <sup>1</sup>	0.25	0.36	1.05	2.45	1.59	1.74	2.18	ND <sup>1</sup>	1.18	2.25	1.52	0.35
Mar-07	2.21	1.34	5.92	0.23	1.84	3.05	5.94	2.18	3.26	5.20	1.31	2.86	4.58	2.56	0.14 <sup>2</sup>
Apr-07	1.93	2.07	6.15	1.26	1.34	3.08	4.76	7.00	7.88	5.10	2.25	4.43	4.28	6.05	0.85
May-07	0.68	0.67	2.15	0.37	0.63	1.40	2.10	2.19	2.44	1.73	0.46	1.26	1.43	1.34	0.49 <sup>2</sup>
Jun-07	1.64	1.27	2.59	ND <sup>5</sup>	0.78	1.00	2.66	1.43	2.56	2.02	0.96	1.40	2.91	1.21 <sup>3</sup>	0.78
Jul-07	0.59	0.39	1.67	0.24	0.49	0.81	1.82	0.55	1.53	1.41	0.28	0.47	0.71	1.21 <sup>3</sup>	0.29
Aug-07	0.71	0.49	0.45	2.98 <sup>8</sup>	0.35 <sup>2</sup>	0.92	2.02	1.33	2.59	2.25	0.25	0.85	1.29	ND <sup>7</sup>	0.35 <sup>2</sup>
Sep-07	0.58	0.32	2.74	0.16	0.55	1.10	2.36	1.47	3.25 <sup>2</sup>	2.60	0.40	1.28	1.36	1.55	0.18
Oct-07	2.49	1.89	5.08	0.67	2.24	3.38	4.31	2.66	4.30 <sup>2</sup>	4.68	1.84	2.40	3.88	3.25	0.59
Nov-07	0.81	0.33	2.85	0.29	ND <sup>1</sup>	1.45	3.05	1.05	2.57 <sup>2</sup>	0.99	0.51	0.91	1.59	1.12	ND <sup>4</sup>
Dec-07	2.24	0.93 <sup>2</sup>	3.87	0.31	1.37 <sup>2</sup>	2.24	2.73	2.08	ND <sup>1</sup>	2.73	1.55	1.61	2.70	2.65	0.49
Mean	1.26	0.84	3.16	0.39	0.96	1.67	2.93	2.01	2.99	2.70	0.91	1.59	2.29	2.09	0.42
Min	0.23	0.16	0.45	0.07	0.35	0.59	0.96	0.55	0.82	0.99	0.24	0.39	0.49	0.50	0.08
Max	2.49	2.07	6.15	1.26	2.24	3.38	5.94	7.00	7.88	5.20	2.25	4.43	4.58	6.05	0.85
SD	0.79	0.66	1.88	0.34	0.64	0.99	1.40	1.70	1.87	1.47	0.72	1.15	1.39	1.54	0.25
CV (%)	62.6	77.7	59.4	89.0	66.8	59.5	47.8	84.5	62.4	54.7	78.7	72.3	60.5	73.9	59.9
N	12	12	11	10	11	12	12	12	11	12	11	12	12	11	11

Month	Site 18	Site 19	Site 22	Site 36	Site 41	Site 44	Site 47	Site 60	Site 77	Site 97	Site 98	Site 99	Site 100	Site 102	Site 103
Jan-07	0.21	0.16	0.27 <sup>2</sup>	2.46	0.10	0.33	0.14 <sup>2</sup>	0.78	0.89	1.80	0.02 <sup>8</sup>	0.53	0.26	1.62	0.0 <sup>2,3</sup>
Feb-07	0.89	0.33	0.41 <sup>2</sup>	2.47	ND <sup>1</sup>	1.17	0.95 <sup>2</sup>	1.36	0.73	1.07	2.59	0.80	ND <sup>1</sup>	3.39	0.0 <sup>2,3</sup>
Mar-07	1.54	1.64	1.44	7.47	0.99	3.60 <sup>2</sup>	1.15	3.04	ND <sup>5</sup>	4.63	4.26	1.87	1.84	2.57	4.22
Apr-07	2.47	1.09	2.59	7.55	0.72	3.43	0.51	2.50	1.97	3.08	6.27	4.57	3.92	ND <sup>1</sup>	6.93
May-07	0.65	0.65	0.74 <sup>2</sup>	3.18	0.32	0.95	0.33	1.11	0.51	1.56	1.80	1.34	1.10	1.70	0.85
Jun-07	1.46	0.98	1.46	3.85	0.41	1.49	0.41	2.07	0.59	2.09	1.83	1.75	1.29	1.94	1.43
Jul-07	0.48	0.80	0.87	2.38	0.19	0.71	0.33	1.06	0.30	2.04	ND <sup>4</sup>	0.89	0.54	1.44	1.05
Aug-07	0.56	0.76	0.29	3.97	0.24	0.75	0.20 <sup>2</sup>	1.52	0.28	2.44	2.01	0.98	0.75	2.28	1.37
Sep-07	0.43	ND <sup>6</sup>	ND <sup>1</sup>	3.12	0.33	1.04	0.82	1.10	0.22	2.93	2.27	1.67	0.62	ND <sup>4</sup>	2.18
Oct-07	1.91	2.24	2.15	6.91	0.71	2.83	0.55	3.53	1.41	4.78	4.33	3.02	1.86	1.82	2.52
Nov-07	0.84	0.41	0.74	2.84	0.15	0.98	0.25	0.85	0.40	3.29	1.73	1.09	0.80	2.69	1.27 <sup>2</sup>
Dec-07	1.17	1.68	0.99	1.37	0.50	0.87	ND <sup>1</sup>	2.67	0.39	3.11	3.24	2.50	1.34	3.89	1.52
Mean	1.05	0.98	1.09	3.96	0.42	1.51	0.51	1.80	0.66	2.74	3.03	1.75	1.30	2.33	2.33
Min	0.21	0.16	0.27	1.37	0.10	0.33	0.14	0.78	0.20	1.07	1.73	0.53	0.26	1.44	0.85
Max	2.47	2.24	2.59	7.55	0.99	3.60	1.15	3.53	1.97	4.78	6.27	4.57	3.92	3.89	6.93
SD	0.68	0.64	0.75	2.13	0.28	1.12	0.33	0.93	0.54	1.15	1.50	1.15	1.01	0.81	1.89
CV (%)	64.7	65.8	69.3	53.9	66.2	73.9	64.4	51.9	81.8	41.9	49.5	65.5	77.5	34.5	80.9
N	12	11	11	12	11	12	11	12	12	12	10	12	11	10	10

## Notes:

ND<sup>1</sup>: Power off during sampling periodData<sup>2</sup> = Flow < 0.2 l /min (pump not working properly, or intermittent power cuts)Data<sup>3</sup> = Samples exposed for more than one monthND<sup>4</sup> = Samples lost / damagedND<sup>5</sup> = Problems with aerosol samplingND<sup>6</sup> = Water in sampling train, or leak in systemND<sup>7</sup> = Possible contamination because sampling train returned separated0.0<sup>8</sup> = < limit of detection: lower than blanks

NS = Measurement not Started

**Numbers in bold:** Capture = < 75% in the first of the 2 glass denuders

**Table A5.3e Monthly Aerosol Sulphate data at the 30 monitoring sites in the HNO<sub>3</sub> Monitoring Network (Particulate SO<sub>4</sub><sup>2-</sup> (µg m<sup>-3</sup>))**

Month	Site 1	Site 21	Site 24	Site 30	Site 31	Site 32	Site 33	Site 34	Site 83	Site 40	Site 45	Site 70	Site 6B	Site 8C	Site 12
Jan-07	0.12	0.19	0.61	0.23	0.31	0.46	0.50	0.73	0.61	0.93	0.52	0.44	0.57	0.80	0.17
Feb-07	0.12	0.09	ND <sup>1</sup>	ND <sup>5</sup>	0.09	0.13	0.25	ND <sup>8</sup>	0.17	0.24	ND <sup>1</sup>	0.05	0.18	0.16	0.11
Mar-07	1.42	0.66	2.54	0.37	1.03	1.22	2.03	0.93	1.50	2.35	0.86	1.35	2.14	1.22	0.17 <sup>2</sup>
Apr-07	0.98	0.77	2.30	0.98	0.78	1.00	1.65	2.43	2.69	2.23	1.09	1.54	1.67	2.31	0.69
May-07	0.86	0.40	1.08	0.44	0.34	1.04	1.06	1.01	0.88	1.11	0.29	1.07	1.16	1.29	0.47 <sup>2</sup>
Jun-07	1.83	1.02	2.06	ND <sup>5</sup>	1.20	1.41	1.92	1.91	2.23	2.17	1.04	1.54	2.63	1.33 <sup>3</sup>	0.66
Jul-07	0.58	0.29	0.83	0.17	0.22	0.49	1.15	0.51	1.01	0.92	0.25	0.61	0.78	1.33 <sup>3</sup>	0.54
Aug-07	0.68	0.63	1.75	1.00	0.61 <sup>2</sup>	1.00	1.61	1.31	2.10	1.83	0.58	0.97	1.15	ND <sup>7</sup>	0.67 <sup>2</sup>
Sep-07	0.32	0.37	1.30	0.40	0.59	0.50	0.85	0.89	1.71 <sup>2</sup>	1.29	0.25	0.58	0.79	0.87	0.38
Oct-07	1.10	0.81	1.92	0.66	0.99	1.16	1.72	1.35	2.45 <sup>2</sup>	1.74	0.99	1.11	1.47	1.40	0.60
Nov-07	0.20	0.18	1.08	0.29	ND <sup>1</sup>	0.71	1.21	0.62	0.91 <sup>2</sup>	0.41	0.60	0.14	0.49	0.43	ND <sup>4</sup>
Dec-07	0.97	0.25 <sup>2</sup>	2.36	0.34	0.42 <sup>2</sup>	1.07	1.44	1.43	ND <sup>1</sup>	0.99	0.64	0.78	1.08	1.68	0.34
Mean	0.76	0.47	1.62	0.49	0.60	0.85	1.28	1.19	1.48	1.35	0.65	0.85	1.18	1.17	0.44
Min	0.12	0.09	0.61	0.17	0.09	0.13	0.25	0.51	0.17	0.24	0.25	0.05	0.18	0.16	0.11
Max	1.83	1.02	2.54	1.00	1.20	1.41	2.03	2.43	2.69	2.35	1.09	1.54	2.63	2.31	0.69
SD	0.54	0.30	0.67	0.30	0.36	0.39	0.55	0.58	0.82	0.71	0.31	0.50	0.71	0.59	0.22
CV (%)	70.1	63.1	41.2	60.5	60.7	45.5	43.0	48.4	55.6	52.4	48.3	59.1	60.2	50.6	49.9
N	12	12	11	10	11	12	12	11	11	12	11	12	12	11	11

Month	Site 18	Site 19	Site 22	Site 36	Site 41	Site 44	Site 47	Site 60	Site 77	Site 97	Site 98	Site 99	Site 100	Site 102	Site 103
Jan-07	0.17	0.71	0.21 <sup>2</sup>	1.36	0.20	0.52	0.45 <sup>2</sup>	0.75	0.89	0.87	0.74	0.47	0.63	0.94	0.0 <sup>2,3</sup>
Feb-07	0.08	0.11	0.10 <sup>2</sup>	0.09	ND <sup>1</sup>	ND <sup>5</sup>	ND <sup>1,5</sup>	0.10	0.57	0.80	0.18	0.16	ND <sup>1</sup>	0.82	0.0 <sup>2,3</sup>
Mar-07	0.87	1.41	0.76	3.07	0.89	1.29 <sup>2</sup>	0.89	1.48	ND <sup>5</sup>	1.27	1.86	0.98	1.29	0.43	1.83
Apr-07	1.32	1.04	0.68	2.91	0.62	1.45	0.22	0.08	1.16	0.84	2.29	1.93	1.65	ND <sup>1</sup>	2.36
May-07	0.54	0.77	0.60 <sup>2</sup>	1.79	0.43	0.66	0.58	1.15	0.63	0.41	1.08	0.48	0.84	0.65	0.91
Jun-07	2.03	1.22	1.23	3.17	0.61	1.28	0.68	1.75	1.13	1.59	1.69	1.86	1.55	1.47	1.78
Jul-07	0.49	0.81	0.72	1.60	0.34	0.69	0.19	0.79	0.47	1.09	ND <sup>4</sup>	0.61	0.43	0.56	1.11
Aug-07	0.67	1.25	0.40	2.59	0.52	0.88	0.56 <sup>2</sup>	1.00	0.52	1.88	1.65	1.18	0.97	1.66	1.30
Sep-07	0.40	ND <sup>6</sup>	ND <sup>1</sup>	0.34	0.48	0.88	0.56	0.70	0.39	1.17	1.07	0.84	0.64	ND <sup>4</sup>	1.10
Oct-07	0.89	2.23	0.78	3.53	0.61	1.10	0.69	1.66	0.78	1.67	1.55	1.35	1.18	0.60	1.44
Nov-07	0.45	0.42	0.36	1.75	0.17	0.79	0.37	0.34	0.48	1.06	0.86	0.46	0.33	0.95	1.49 <sup>2</sup>
Dec-07	0.45	1.21	0.47	2.69	0.25	0.26	ND <sup>1</sup>	0.89	0.21	1.22	1.58	1.10	0.73	1.34	1.19
Mean	0.70	1.02	0.57	2.07	0.47	0.89	0.52	0.89	0.66	1.16	1.22	0.95	0.93	0.94	1.45
Min	0.08	0.11	0.10	0.09	0.17	0.26	0.19	0.08	0.21	0.41	0.11	0.16	0.33	0.43	0.91
Max	2.03	2.23	1.23	3.53	0.89	1.45	0.89	1.75	1.16	1.88	2.29	1.93	1.65	1.66	2.36
SD	0.54	0.56	0.31	1.11	0.22	0.36	0.22	0.56	0.30	0.41	0.67	0.56	0.44	0.42	0.44
CV (%)	77.0	54.9	54.6	53.5	46.2	40.6	41.9	62.3	46.0	35.8	54.6	59.0	47.3	44.5	30.0
N	12	11	11	12	11	11	10	12	11	12	12	12	11	10	10

Notes:

ND<sup>1</sup>: Power off during sampling period

Data<sup>2</sup> = Flow < 0.2 l /min (pump not working properly, or intermittent power cuts)

Data<sup>3</sup> = Samples exposed for more than one month

ND<sup>4</sup> = Samples lost / damaged

ND<sup>5</sup> = Problems with aerosol sampling

ND<sup>6</sup> = Water in sampling train, or leak in system

ND<sup>7</sup> = Possible contamination because sampling train returned separated

0.0<sup>8</sup> = < limit of detection: lower than blanks

NS = Measurement not Started

**Numbers in bold:** Capture = < 75% in the first of the 2 glass denuders



**Table A5.3f Monthly Aerosol Chloride data at the 30 monitoring sites in the HNO<sub>3</sub> Monitoring Network (Particulate Cl<sup>-</sup> (µg m<sup>-3</sup>))**

Month	Site 1	Site 21	Site 24	Site 30	Site 31	Site 32	Site 33	Site 34	Site 83	Site 40	Site 45	Site 70	Site 6B	Site 8C	Site 12
Jan-07	2.38	1.35	2.18	2.14	2.92	2.37	2.45	3.41	1.93	2.36	2.82	3.40	2.91	4.37	2.46
Feb-07	1.57	0.62	ND <sup>1</sup>	1.43	0.49	1.12	1.68	2.31	1.90	1.82	ND <sup>1</sup>	2.33	1.81	3.20	0.97
Mar-07	2.45	1.60	2.20	2.14	2.18	2.20	2.37	3.15	2.69	2.34	2.29	2.90	2.22	4.38	3.04 <sup>2</sup>
Apr-07	1.10	0.95	1.36	1.02	0.85	0.98	1.48	0.72	1.33	1.15	1.02	0.74	1.11	1.02	1.18
May-07	1.20	0.89	1.43	1.00	1.02	1.01	1.36	1.85	2.68	1.05	1.36	1.63	1.36	2.44	1.92 <sup>2</sup>
Jun-07	0.64	0.84	0.82	ND <sup>5</sup>	0.53	0.50	0.81	1.30	1.14	0.51	0.98	1.19	0.72	1.31 <sup>3</sup>	1.53
Jul-07	0.63	0.33	1.07	0.56	0.88	0.50	0.76	1.55	1.88	0.83	0.88	1.31	1.07	1.31 <sup>3</sup>	1.16
Aug-07	1.05	0.70	1.21	1.12	0.88 <sup>2</sup>	1.11	1.69	1.03	1.14	1.24	1.34	1.20	0.99	ND <sup>7</sup>	2.08 <sup>2</sup>
Sep-07	1.58	1.16	1.48	1.85	1.27	1.45	1.63	1.41	1.36 <sup>2</sup>	1.53	1.39	1.46	1.41	2.10	2.41
Oct-07	0.97	0.73	0.92	1.35	0.73	0.76	0.72	0.85	1.13 <sup>2</sup>	0.99	1.24	1.03	0.86	1.17	0.83
Nov-07	1.63	1.16	1.96	1.59	ND <sup>1</sup>	1.69	1.66	1.89	1.96 <sup>2</sup>	0.35	2.40	2.19	1.71	2.40	ND <sup>4</sup>
Dec-07	1.70	0.78 <sup>2</sup>	1.90	1.46	1.18 <sup>2</sup>	1.27	1.75	2.70	ND <sup>1</sup>	1.21	1.90	2.43	2.12	3.63	1.27
Mean	1.41	0.93	1.50	1.42	1.18	1.25	1.53	1.85	1.74	1.28	1.60	1.82	1.52	2.49	1.71
Min	0.63	0.33	0.82	0.56	0.49	0.50	0.72	0.72	1.13	0.35	0.88	0.74	0.72	1.02	0.83
Max	2.45	1.60	2.20	2.14	2.92	2.37	2.45	3.41	2.69	2.36	2.82	3.40	2.91	4.38	3.04
SD	0.59	0.35	0.49	0.49	0.74	0.60	0.56	0.88	0.58	0.64	0.65	0.82	0.65	1.25	0.72
CV (%)	42.1	37.4	32.7	34.5	62.7	47.9	36.8	47.9	33.1	49.8	40.6	45.1	42.7	50.4	41.8
N	12	12	11	11	11	12	12	12	11	12	11	12	12	11	11

Month	Site 18	Site 19	Site 22	Site 36	Site 41	Site 44	Site 47	Site 60	Site 77	Site 97	Site 98	Site 99	Site 100	Site 102	Site 103
Jan-07	2.03	5.16	1.28 <sup>2</sup>	3.79	1.78 <sup>2</sup>	3.20	3.47	3.12	2.39	2.63	2.58	2.30	3.95	2.72	0.0 <sup>2,3</sup>
Feb-07	1.40	4.15	0.18 <sup>2</sup>	2.16	ND <sup>1</sup>	2.58	6.27 <sup>2</sup>	1.78	2.88	0.46	2.09	0.85	ND <sup>1</sup>	2.09	0.0 <sup>2,3</sup>
Mar-07	2.30	5.59	1.74	2.26	1.05	2.17 <sup>2</sup>	1.34	3.02	ND <sup>5</sup>	1.60	2.12	2.24	3.25	2.35	3.87
Apr-07	1.28	4.09	0.77	1.17	0.57	1.31	1.62	1.25	1.02	0.71	1.04	0.99	0.91	ND <sup>1</sup>	1.86
May-07	1.13	3.66	1.02 <sup>2</sup>	1.50	0.54	1.36	2.15	1.59	1.31	1.05	1.38	0.99	1.68	1.05	4.13
Jun-07	0.65	3.39	0.40	0.94	0.41	1.24	1.02	1.28	0.60	1.06	0.87	0.63	0.62	0.71	2.96
Jul-07	0.54	2.02	0.98	1.06	0.33	0.90	0.84	0.86	0.74	1.09	ND <sup>4</sup>	0.78	1.04	0.73	3.11
Aug-07	0.91	3.12	0.38	1.01	0.72	1.57	1.66 <sup>2</sup>	1.31	1.14	1.15	0.91	0.82	1.48	1.86	2.30
Sep-07	1.15	ND <sup>6</sup>	ND <sup>1</sup>	1.39	1.18	2.44	1.66	1.88	1.52	1.58	1.26	1.09	1.54	ND <sup>4</sup>	2.33
Oct-07	0.96	8.74	0.65	0.82	0.79	1.73	2.82	1.05	1.08	0.83	0.78	1.11	0.97	0.44	2.21
Nov-07	1.60	2.19	1.17	2.16	0.87	2.49	2.55	2.46	2.02	1.73	1.66	1.57	2.13	2.01	7.53 <sup>2</sup>
Dec-07	1.29	4.83	0.81	2.39	0.56	0.34	ND <sup>1</sup>	2.12	1.43	1.99	1.88	1.04	2.21	1.58	4.03
Mean	1.27	4.27	0.85	1.72	0.80	1.78	2.31	1.81	1.60	1.32	1.51	1.20	1.80	1.55	3.43
Min	0.54	2.02	0.18	0.82	0.33	0.34	0.84	0.86	0.60	0.46	0.78	0.63	0.62	0.44	1.86
Max	2.30	8.74	1.74	3.79	1.78	3.20	6.27	3.12	3.03	2.63	2.58	2.30	3.95	2.72	7.53
SD	0.52	1.87	0.45	0.87	0.41	0.82	1.53	0.74	0.81	0.61	0.60	0.55	1.03	0.78	1.65
CV (%)	40.7	43.7	52.9	50.3	51.9	45.9	66.3	41.1	50.5	45.9	39.9	45.7	57.4	50.1	48.1
N	12	11	11	12	11	12	11	12	12	12	11	12	11	10	10

## Notes:

ND<sup>1</sup>: Power off during sampling periodData<sup>2</sup> = Flow < 0.2 l/min (pump not working properly, or intermittent power cuts)Data<sup>3</sup> = Samples exposed for more than one monthND<sup>4</sup> = Samples lost / damagedND<sup>5</sup> = Problems with aerosol samplingND<sup>6</sup> = Water in sampling train, or leak in systemND<sup>7</sup> = Possible contamination because sampling train returned separated0.0<sup>8</sup> = < limit of detection: lower than blanks

NS = Measurement not Started

**Numbers in bold:** Capture = < 75% in the first of the 2 glass denuders

**Table A5.3g Monthly Calcium data at the 30 monitoring sites in the HNO<sub>3</sub> Monitoring Network (Ca<sup>2+</sup> (µg m<sup>-3</sup>))**

Month	Site 1	Site 21	Site 24	Site 30	Site 31	Site 32	Site 33	Site 34	Site 83	Site 40	Site 45	Site 70	Site 6B	Site 8C	Site 12
Jan-07	0.0 <sup>8</sup>	0.0 <sup>8</sup>	0.0 <sup>8</sup>	0.0 <sup>8</sup>	0.0 <sup>8</sup>	0.0 <sup>8</sup>	0.0 <sup>8</sup>	0.09	0.22	0.16	0.04	0.0 <sup>8</sup>	0.03	0.0 <sup>8</sup>	0.0 <sup>8</sup>
Feb-07	ND <sup>5</sup>	ND <sup>5</sup>	ND <sup>1</sup>	ND <sup>5</sup>	ND <sup>5</sup>	ND <sup>5</sup>	ND <sup>5</sup>	ND <sup>5</sup>	ND <sup>5</sup>	ND <sup>5</sup>	ND <sup>1</sup>	ND <sup>5</sup>	ND <sup>5</sup>	-0.01	-0.02
Mar-07	0.01	0.01	0.04	0.01	0.01	0.04	0.03	0.02	0.03	0.02	0.05	0.02	0.02	0.04	0.01 <sup>2</sup>
Apr-07	0.01	0.01	0.05	0.02	0.00	0.01	0.05	0.04	0.03	0.03	0.01	0.01	0.02	0.04	0.01
May-07	0.01	0.00	0.02	0.00	0.00	0.01	0.03	0.01	0.01	0.01	0.01	0.01	0.02	0.03	0.00 <sup>2</sup>
Jun-07	0.01	0.01	0.02	ND <sup>5</sup>	0.01	0.01	0.02	0.01	0.01	0.01	0.01	0.01	0.03	0.01 <sup>3</sup>	0.04
Jul-07	0.00	0.00	0.03	0.00	0.00	0.01	0.04	0.01	0.02	0.01	0.00	0.01	0.01	0.01 <sup>3</sup>	0.08
Aug-07	0.00	-0.01	0.13	-0.01	-0.04 <sup>2</sup>	0.05	0.26	0.02	0.02	0.18	0.01	-0.03	0.07	ND <sup>7</sup>	-0.07 <sup>2</sup>
Sep-07	0.02	0.03	0.03	0.02	0.03	0.02	0.05	0.02	0.0 <sup>2,8</sup>	0.03	0.02	0.02	0.02	0.02	0.02
Oct-07	0.01	0.0 <sup>8</sup>	0.01	0.01	0.0 <sup>8</sup>	0.02	0.02	0.01	0.02 <sup>2</sup>	0.02	0.01	0.01	0.01	0.02	0.01
Nov-07	0.00	0.00	0.03	0.00	ND <sup>1</sup>	0.01	0.02	0.01	0.00 <sup>2</sup>	0.03	0.01	0.01	0.02	0.02	ND <sup>4</sup>
Dec-07	0.00	-0.02 <sup>2</sup>	0.01	0.00	0.00 <sup>2</sup>	0.00	0.01	0.02	ND <sup>1</sup>	0.00	0.01	0.01	0.01	0.03	0.00
Mean	0.01	0.00	0.04	0.01	0.00	0.02	0.05	0.03	0.04	0.05	0.02	0.01	0.02	0.02	0.01
Min	0.00	-0.02	0.01	-0.01	-0.04	0.00	0.01	0.01	0.00	0.00	0.00	-0.03	0.01	-0.01	-0.07
Max	0.02	0.03	0.13	0.02	0.03	0.05	0.26	0.09	0.22	0.18	0.05	0.02	0.07	0.04	0.08
SD	0.01	0.02	0.04	0.01	0.02	0.02	0.08	0.02	0.07	0.06	0.01	0.02	0.02	0.02	0.04
CV (%)	102.2	387.1	99.7	149.8	3547	80.8	141.7	88.9	176.9	136.5	83.6	190.8	66.3	73.9	503.1
N	10	9	10	9	8	10	10	11	9	11	11	10	11	10	10

Month	Site 18	Site 19	Site 22	Site 36	Site 41	Site 44	Site 47	Site 60	Site 77	Site 97	Site 98	Site 99	Site 100	Site 102	Site 103
Jan-07	0.0 <sup>8</sup>	0.0 <sup>8</sup>	0.0 <sup>2,8</sup>	0.27	0.0 <sup>2,8</sup>	0.19	0.0 <sup>8</sup>	0.0 <sup>8</sup>	0.05	0.0 <sup>8</sup>	0.09	0.0 <sup>8</sup>	0.25	0.04	ND <sup>2,3</sup>
Feb-07	ND <sup>5</sup>	ND <sup>5</sup>	<b>ND<sup>5</sup></b>	ND <sup>5</sup>	ND <sup>1,5</sup>	ND <sup>5</sup>	ND <sup>1,5</sup>	ND <sup>5</sup>	0.02	0.43	ND <sup>5</sup>	ND <sup>5</sup>	ND <sup>1</sup>	0.01	ND <sup>2,3</sup>
Mar-07	0.01	0.04	0.01	0.08	0.01	0.02 <sup>2</sup>	0.01	0.04	ND <sup>5</sup>	0.04	0.03	0.01	0.03	0.00	0.04
Apr-07	0.01	0.03	0.0 <sup>8</sup>	0.10	0.00	0.01	0.00	0.03	0.01	0.01	0.03	0.02	0.02	ND <sup>1</sup>	0.04
May-07	0.00	0.02	0.00 <sup>2</sup>	0.05	0.01	0.01	0.00	0.02	0.00	0.00	0.01	0.01	0.01	0.01	0.02
Jun-07	0.02	0.02	0.00	0.03	0.0 <sup>8</sup>	0.01	0.01	0.02	0.01	0.02	0.01	0.01	0.01	0.01	0.02
Jul-07	0.01	0.02	0.01	0.03	0.00	0.01	0.00	0.02	0.00	0.02	ND <sup>4</sup>	0.01	0.00	0.01	0.06
Aug-07	0.27	0.04	-0.01	0.21	-0.01	0.02	-0.07 <sup>2</sup>	0.16	-0.03	0.05	0.10	0.02	0.01	0.08	0.04
Sep-07	0.0 <sup>8</sup>	ND <sup>6</sup>	ND <sup>1</sup>	0.08	0.02	0.02	0.02	0.04	0.02	0.05	0.03	0.03	0.02	ND <sup>4</sup>	0.02
Oct-07	0.01	0.11	0.02	0.07	0.01	0.04	0.02	0.02	0.01	0.02	0.02	0.03	0.01	0.01	0.02
Nov-07	0.01	0.01	0.00	0.08	0.00	0.02	0.01	0.04	0.01	0.02	0.04	0.01	0.02	0.03	0.03 <sup>2</sup>
Dec-07	0.00	0.04	0.00	0.05	0.00	0.00	ND <sup>1</sup>	0.01	0.00	0.01	0.01	-0.01	0.01	0.00	0.03
Mean	0.04	0.04	0.01	0.09	0.00	0.03	0.00	0.04	0.01	0.06	0.04	0.01	0.04	0.02	0.03
Min	0.00	0.01	-0.01	0.03	-0.01	0.00	-0.07	0.01	-0.03	0.00	0.01	-0.01	0.00	0.00	0.02
Max	0.27	0.11	0.02	0.27	0.02	0.19	0.02	0.16	0.05	0.43	0.10	0.03	0.25	0.08	0.06
SD	0.09	0.03	0.01	0.08	0.01	0.05	0.03	0.04	0.02	0.12	0.03	0.01	0.07	0.02	0.01
CV (%)	227.5	84.9	159.7	79.3	210.3	172.8	-752.8	108.6	209.9	200.9	84.4	78.6	199.7	110.9	42.7
N	9	9	8	11	9	11	10	10	11	11	11	10	11	10	10

Notes:

ND<sup>1</sup>: Power off during sampling period

Data<sup>2</sup> = Flow < 0.2 l/min (pump not working properly, or intermittent power cuts)

Data<sup>3</sup> = Samples exposed for more than one month

ND<sup>4</sup> = Samples lost / damaged

ND<sup>5</sup> = Problems with aerosol sampling

ND<sup>6</sup> = Water in sampling train, or leak in system

ND<sup>7</sup> = Possible contamination because sampling train returned separated

0.0<sup>8</sup> = < limit of detection: lower than blanks

NS = Measurement not Started

**Numbers in bold:** Capture = < 75% in the first of the 2 glass denuders

**Table A5.3h Monthly Magnesium data at the 30 monitoring sites in the HNO<sub>3</sub> Monitoring Network (Mg<sup>2+</sup> (µg m<sup>-3</sup>))**

Month	Site 1	Site 21	Site 24	Site 30	Site 31	Site 32	Site 33	Site 34	Site 83	Site 40	Site 45	Site 70	Site 6B	Site 8C	Site 12
Jan-07	0.11	0.0 <sup>8</sup>	0.11	0.09	0.0 <sup>8</sup>	0.11	0.0 <sup>8</sup>	0.23	0.30	0.21	0.17	0.16	0.18	0.14	0.12
Feb-07	ND <sup>5</sup>	ND <sup>5</sup>	ND <sup>1</sup>	ND <sup>5</sup>	ND <sup>5</sup>	ND <sup>5</sup>	ND <sup>5</sup>	ND <sup>5</sup>	ND <sup>5</sup>	ND <sup>5</sup>	ND <sup>1</sup>	ND <sup>5</sup>	ND <sup>5</sup>	0.0 <sup>8</sup>	0.0 <sup>8</sup>
Mar-07	0.06	0.05	0.06	0.05	0.05	0.10	0.07	0.09	0.07	0.02	0.09	0.06	0.06	0.14	0.05 <sup>2</sup>
Apr-07	0.02	0.02	0.05	0.04	0.02	0.03	0.05	0.02	0.04	0.04	0.02	0.02	0.04	0.04	0.03
May-07	0.01	0.01	0.04	0.02	0.01	0.02	0.03	0.04	0.04	0.01	0.02	0.04	0.03	0.07	0.03 <sup>2</sup>
Jun-07	0.01	0.01	0.02	ND <sup>5</sup>	0.01	0.02	0.03	0.03	0.02	0.01	0.02	0.02	0.02	0.03 <sup>3</sup>	0.04
Jul-07	0.01	0.01	0.04	0.01	0.01	0.01	0.04	0.04	0.05	0.02	0.02	0.05	0.03	0.03 <sup>3</sup>	0.05
Aug-07	0.05	0.03	0.07	0.06	0.04 <sup>2</sup>	0.06	0.10	0.06	0.04	0.07	0.06	0.05	0.06	ND <sup>7</sup>	0.10 <sup>2</sup>
Sep-07	0.05	0.03	0.04	0.04	0.03	0.02	0.05	0.04	0.0 <sup>2,8</sup>	0.04	0.03	0.03	0.02	0.04	0.05
Oct-07	0.02	0.02	0.03	0.03	0.01	0.03	0.02	0.03	0.03 <sup>2</sup>	0.03	0.03	0.02	0.02	0.03	0.01
Nov-07	0.04	0.03	0.06	0.04	ND <sup>1</sup>	0.05	0.05	0.06	0.02 <sup>2</sup>	0.08	0.08	0.07	0.07	0.09	ND <sup>4</sup>
Dec-07	0.04	0.02 <sup>2</sup>	0.05	0.04	0.03 <sup>2</sup>	0.04	0.05	0.08	ND <sup>1</sup>	0.02	0.05	0.06	0.05	0.12	0.02
Mean	0.04	0.02	0.05	0.04	0.02	0.04	0.05	0.07	0.07	0.05	0.05	0.05	0.05	0.07	0.05
Min	0.01	0.01	0.02	0.01	0.01	0.01	0.02	0.02	0.02	0.01	0.02	0.02	0.02	0.03	0.01
Max	0.11	0.05	0.11	0.09	0.05	0.11	0.10	0.23	0.30	0.21	0.17	0.16	0.18	0.14	0.12
SD	0.03	0.01	0.03	0.02	0.01	0.03	0.02	0.06	0.09	0.06	0.05	0.04	0.05	0.05	0.03
CV (%)	75.9	58.5	49.1	52.9	54.6	76.5	45.4	87.8	129.1	109.5	84.6	76.4	87.4	60.9	66.5
N	11	10	11	10	9	11	10	11	9	11	11	11	11	10	10

Month	Site 18	Site 19	Site 22	Site 36	Site 41	Site 44	Site 47	Site 60	Site 77	Site 97	Site 98	Site 99	Site 100	Site 102	Site 103
Jan-07	0.10	0.13	0.0 <sup>2,8</sup>	0.29	0.0 <sup>2,8</sup>	0.25	0.16	0.0 <sup>8</sup>	0.16	0.14	0.20	0.0 <sup>8</sup>	0.31	0.17	ND <sup>2,3</sup>
Feb-07	Nd	ND <sup>5</sup>	ND <sup>5</sup>	ND <sup>5</sup>	ND <sup>1,5</sup>	ND <sup>5</sup>	ND <sup>1,5</sup>	ND <sup>5</sup>	0.06	0.23	ND <sup>5</sup>	ND <sup>5</sup>	ND <sup>1</sup>	0.02	ND <sup>2,3</sup>
Mar-07	0.05	0.21	0.03	0.07	0.02	0.05 <sup>2</sup>	0.04	0.09	ND <sup>5</sup>	0.07	0.06	0.03	0.09	0.01	0.14
Apr-07	0.04	0.15	0.01	0.05	0.01	0.03	0.03	0.03	0.03	0.02	0.04	0.02	0.03	ND <sup>1</sup>	0.07
May-07	0.01	0.09	0.01 <sup>2</sup>	0.04	0.01	0.01	0.03	0.04	0.02	0.01	0.03	0.01	0.03	0.02	0.11
Jun-07	0.03	0.07	0.01	0.03	0.01	0.02	0.02	0.03	0.01	0.03	0.02	0.02	0.01	0.02	0.08
Jul-07	0.02	0.06	0.03	0.03	0.01	0.02	0.01	0.03	0.01	0.03	ND <sup>4</sup>	0.02	0.02	0.02	0.17
Aug-07	0.09	0.20	0.03	0.07	0.03	0.07	0.08 <sup>2</sup>	0.07	0.05	0.06	0.06	0.06	0.07	0.07	0.14
Sep-07	0.02	ND <sup>6</sup>	ND <sup>1</sup>	0.05	0.02	0.06	0.04	0.04	0.04	0.04	0.04	0.03	0.04	ND <sup>4</sup>	0.05
Oct-07	0.02	0.38	0.02	0.03	0.02	0.08	0.07	0.03	0.02	0.03	0.03	0.03	0.02	0.02	0.07
Nov-07	0.05	0.07	0.03	0.08	0.03	0.08	0.07	0.08	0.06	0.06	0.06	0.04	0.08	0.07	0.14 <sup>2</sup>
Dec-07	0.03	0.19	0.02	0.06	0.01	0.01	ND <sup>1</sup>	0.05	0.02	0.05	0.05	0.0 <sup>8</sup>	0.06	0.03	0.15
Mean	0.04	0.15	0.02	0.07	0.02	0.06	0.06	0.05	0.04	0.06	0.05	0.03	0.07	0.05	0.11
Min	0.01	0.06	0.01	0.03	0.01	0.01	0.01	0.03	0.00	0.01	0.01	0.01	0.01	0.01	0.05
Max	0.10	0.38	0.03	0.29	0.03	0.25	0.16	0.09	0.16	0.23	0.20	0.06	0.31	0.17	0.17
SD	0.03	0.10	0.01	0.07	0.01	0.07	0.04	0.02	0.04	0.06	0.05	0.01	0.08	0.05	0.04
CV (%)	70.7	63.5	48.1	103.1	47.9	112.6	77.7	47.2	103.2	97.6	94.7	49.5	118.4	110.7	36.7
N	11	10	9	11	10	11	10	10	12	12	11	9	11	10	10

## Notes:

ND<sup>1</sup>: Power off during sampling periodData<sup>2</sup> = Flow < 0.2 l/min (pump not working properly, or intermittent power cuts)Data<sup>3</sup> = Samples exposed for more than one monthND<sup>4</sup> = Samples lost / damagedND<sup>5</sup> = Problems with aerosol samplingND<sup>6</sup> = Water in sampling train, or leak in systemND<sup>7</sup> = Possible contamination because sampling train returned separated0.0<sup>8</sup> = < limit of detection: lower than blanks

NS = Measurement not Started

**Numbers in bold:** Capture = < 75% in the first of the 2 glass denuders



**Table A5.3i Monthly Sodium data at the 30 monitoring sites in the HNO<sub>3</sub> Monitoring Network (Na<sup>+</sup> (µg m<sup>-3</sup>))**

Month	Site 1	Site 21	Site 24	Site 30	Site 31	Site 32	Site 33	Site 34	Site 83	Site 40	Site 45	Site 70	Site 6B	Site 8C	Site 12
Jan-07	1.21	0.67	1.37	1.20	1.04	1.29	1.40	1.99	2.13	1.26	1.49	1.86	1.68	2.41	1.34
Feb-07	ND <sup>5</sup>	ND <sup>5</sup>	ND <sup>1</sup>	ND <sup>5</sup>	ND <sup>5</sup>	ND <sup>5</sup>	ND <sup>5</sup>	ND <sup>5</sup>	ND <sup>5</sup>	ND <sup>5</sup>	ND <sup>1</sup>	ND <sup>5</sup>	ND <sup>5</sup>	0.12	ND <sup>5</sup>
Mar-07	1.17	0.69	1.13	1.16	1.07	1.20	1.18	1.59	1.35	1.18	1.19	1.38	1.08	2.22	1.59 <sup>2</sup>
Apr-07	0.82	0.51	0.86	0.73	0.51	0.64	1.17	0.48	0.76	0.89	0.65	0.69	1.00	0.65	0.88
May-07	0.67	0.69	0.86	0.57	0.58	0.79	1.06	1.07	1.54	0.80	0.74	1.13	0.78	1.35	1.43 <sup>2</sup>
Jun-07	0.34	0.39	0.52	ND <sup>5</sup>	0.83	0.31	0.72	0.71	0.68	0.27	0.46	0.61	0.50	0.84 <sup>3</sup>	0.88
Jul-07	0.38	0.20	0.69	0.33	0.50	0.32	0.53	0.88	1.15	0.51	0.48	0.72	0.61	0.84 <sup>3</sup>	0.65
Aug-07	0.41	0.23	0.68	0.57	0.55 <sup>2</sup>	0.63	1.03	0.63	0.64	0.70	0.67	0.69	0.45	ND <sup>7</sup>	1.11 <sup>2</sup>
Sep-07	0.78	0.45	0.87	0.95	0.62	0.76	0.96	0.82	0.64 <sup>2</sup>	0.83	0.74	0.83	0.76	1.16	1.17
Oct-07	0.57	0.38	0.64	0.78	0.41	0.43	0.49	0.63	0.59 <sup>2</sup>	0.64	0.71	0.62	0.57	0.75	0.48
Nov-07	0.97	0.21	0.91	0.61	ND <sup>1</sup>	0.73	0.91	1.19	0.02 <sup>2,5</sup>	1.26	1.19	1.04	0.72	1.25	ND <sup>4</sup>
Dec-07	0.89	0.47 <sup>2</sup>	1.04	0.86	0.69 <sup>2</sup>	0.68	0.90	1.60	ND <sup>1</sup>	0.66	1.16	1.44	1.07	2.00	0.61
Mean	0.75	0.45	0.87	0.78	0.68	0.71	0.94	1.05	1.05	0.82	0.86	1.00	0.84	1.24	1.01
Min	0.34	0.20	0.52	0.33	0.41	0.31	0.49	0.48	0.59	0.27	0.46	0.61	0.45	0.12	0.48
Max	1.21	0.69	1.37	1.20	1.07	1.29	1.40	1.99	2.13	1.26	1.49	1.86	1.68	2.41	1.59
SD	0.30	0.19	0.24	0.28	0.23	0.31	0.28	0.49	0.54	0.32	0.34	0.41	0.35	0.71	0.37
CV (%)	40.6	42.1	27.9	35.5	33.6	44.6	29.4	46.3	50.8	38.6	39.2	41.1	42.3	57.8	36.7
N	11	11	11	10	10	11	11	11	9	11	11	11	11	11	10

Month	Site 18	Site 19	Site 22	Site 36	Site 41	Site 44	Site 47	Site 60	Site 77	Site 97	Site 98	Site 99	Site 100	Site 102	Site 103
Jan-07	1.09	2.80	0.66 <sup>2</sup>	2.04	0.86 <sup>2</sup>	1.70	1.91	0.35	1.75	1.55	1.46	1.24	2.13	2.07	ND <sup>2,3</sup>
Feb-07	ND <sup>5</sup>	ND <sup>5</sup>	ND <sup>5</sup>	ND <sup>5</sup>	ND <sup>1,5</sup>	ND <sup>5</sup>	ND <sup>1,5</sup>	ND <sup>5</sup>	1.40	0.78	ND <sup>5</sup>	ND <sup>5</sup>	ND <sup>1</sup>	0.81	ND <sup>2,3</sup>
Mar-07	0.99	3.16	0.55	1.18	0.46	1.16 <sup>2</sup>	0.72	1.58	ND <sup>5</sup>	0.64	1.08	0.73	1.68	0.09	2.23
Apr-07	0.77	2.63	0.79	0.95	0.33	0.79	0.87	0.80	0.65	0.44	0.86	0.61	0.75	ND <sup>1</sup>	1.24
May-07	0.62	2.23	0.50 <sup>2</sup>	1.11	0.32	0.71	1.16	0.87	0.75	0.63	0.82	0.57	0.92	0.86	2.28
Jun-07	0.51	1.94	0.23	0.66	0.36	0.82	0.53	0.98	0.32	0.61	0.54	0.31	0.56	0.39	1.74
Jul-07	0.33	1.18	0.57	0.71	0.18	0.49	0.53	0.53	0.41	0.71	ND <sup>4</sup>	0.39	0.62	0.39	1.94
Aug-07	0.41	1.95	0.28	0.56	0.30	0.74	0.65 <sup>2</sup>	0.57	0.48	0.50	0.48	0.69	0.70	0.40	1.54
Sep-07	0.59	ND <sup>6</sup>	ND <sup>1</sup>	0.84	0.59	1.46	0.85	0.99	0.79	0.91	0.76	0.59	0.86	ND <sup>4</sup>	1.45
Oct-07	0.58	3.91	0.38	0.57	0.50	0.94	1.60	0.67	0.67	0.55	0.48	0.62	0.59	0.29	1.42
Nov-07	0.73	1.12	0.45	1.21	0.39	1.20	1.41	1.14	0.93	0.69	0.77	0.54	1.35	1.15	4.18 <sup>2</sup>
Dec-07	0.79	2.99	0.40	1.33	0.39	0.22	ND <sup>1</sup>	1.25	0.66	1.05	0.97	0.09	1.32	0.72	2.39
Mean	0.67	2.39	0.48	1.01	0.43	0.93	1.02	0.89	0.75	0.76	0.76	0.58	1.04	0.72	2.04
Min	0.33	1.12	0.23	0.56	0.18	0.22	0.53	0.35	0.15	0.44	0.11	0.09	0.56	0.09	1.24
Max	1.09	3.91	0.79	2.04	0.86	1.70	1.91	1.58	1.75	1.55	1.46	1.24	2.13	2.07	4.18
SD	0.23	0.88	0.17	0.43	0.18	0.43	0.48	0.36	0.45	0.30	0.36	0.29	0.51	0.57	0.85
CV (%)	34.5	36.8	35.5	42.8	42.5	45.8	46.8	40.2	60.2	40.2	47.2	49.2	49.0	79.7	41.7
N	11	10	10	11	11	11	10	11	12	12	11	11	11	10	10

Notes:

ND<sup>1</sup>: Power off during sampling period

Data<sup>2</sup> = Flow < 0.2 l/min (pump not working properly, or intermittent power cuts)

Data<sup>3</sup> = Samples exposed for more than one month

ND<sup>4</sup> = Samples lost / damaged

ND<sup>5</sup> = Problems with aerosol sampling

ND<sup>6</sup> = Water in sampling train, or leak in system

ND<sup>7</sup> = Possible contamination because sampling train returned separated

0.0<sup>8</sup> = < limit of detection: lower than blanks

NS = Measurement not Started

**Numbers in bold:** Capture = < 75% in the first of the 2 glass denuders

**Appendix A5.4 Monthly measurements of gaseous HNO<sub>3</sub> and aerosol NO<sub>3</sub><sup>-</sup>**

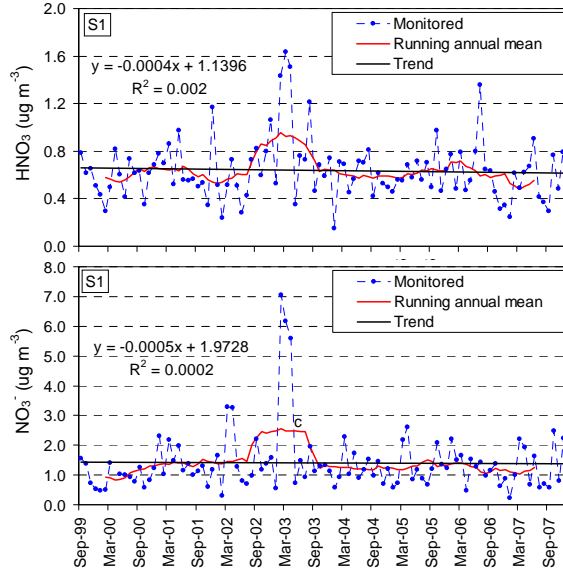
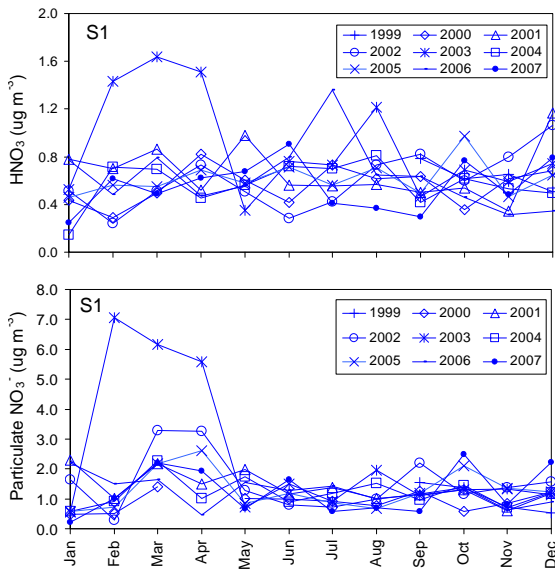

**(i) Bush OTC**

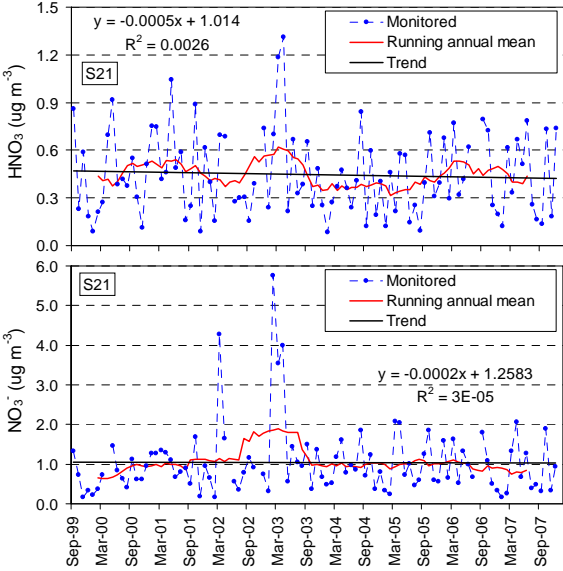
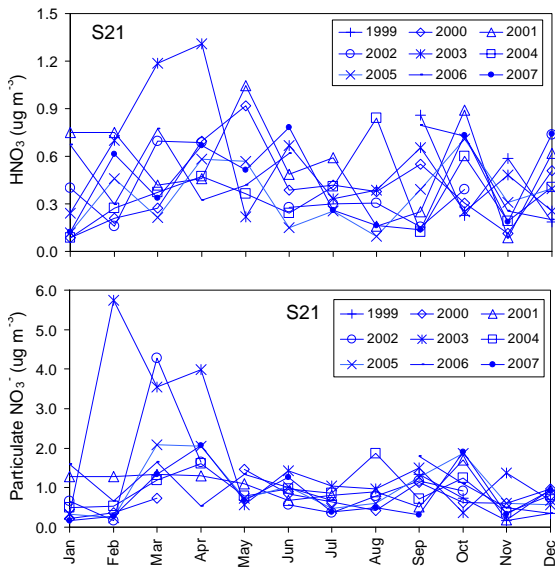

**(ii) Glensagh**

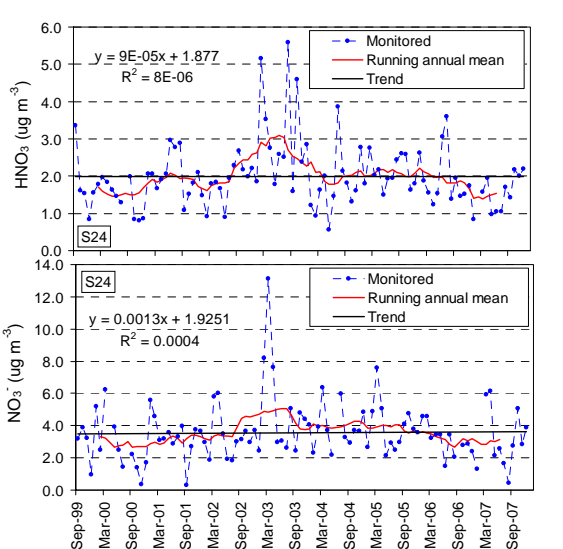
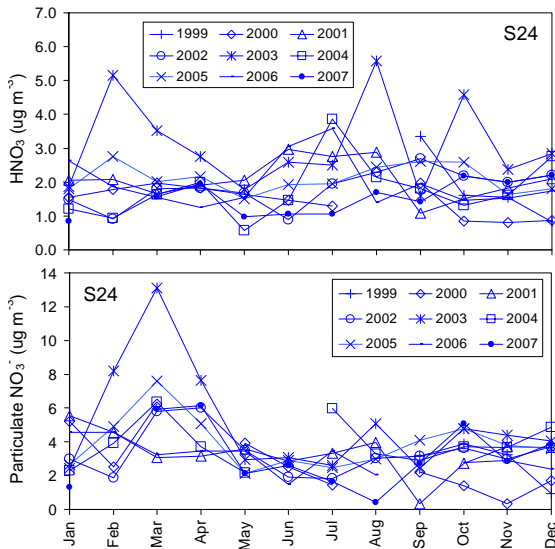

**(iii) Rothamsted**

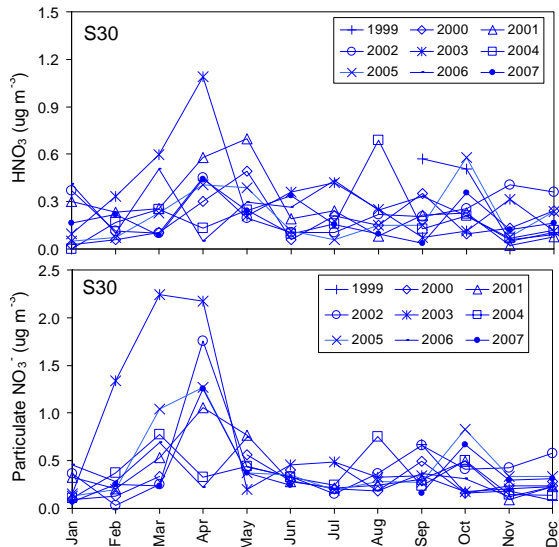

(iv) Strathvaich Dam

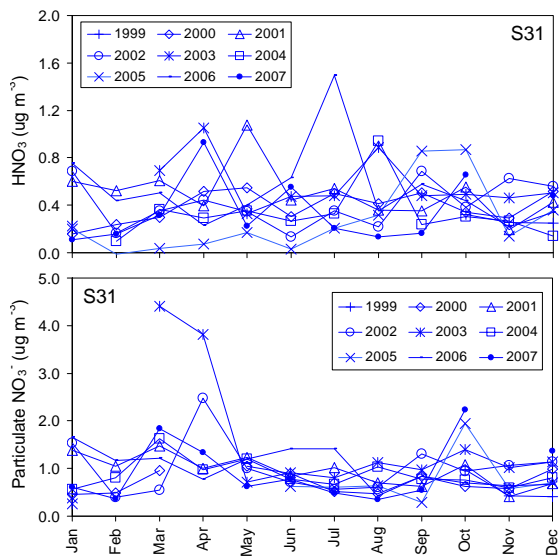
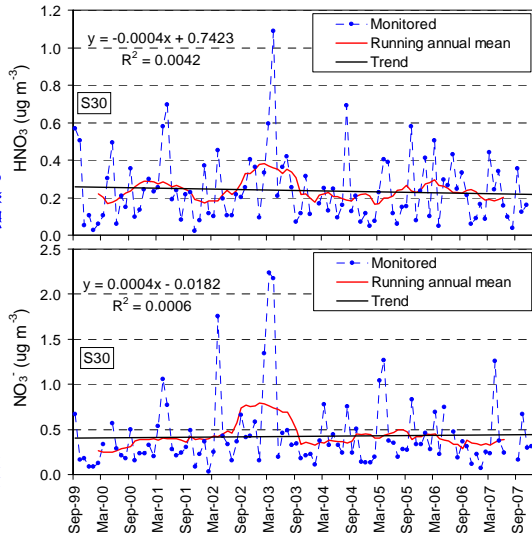

(v) Eskdalemuir

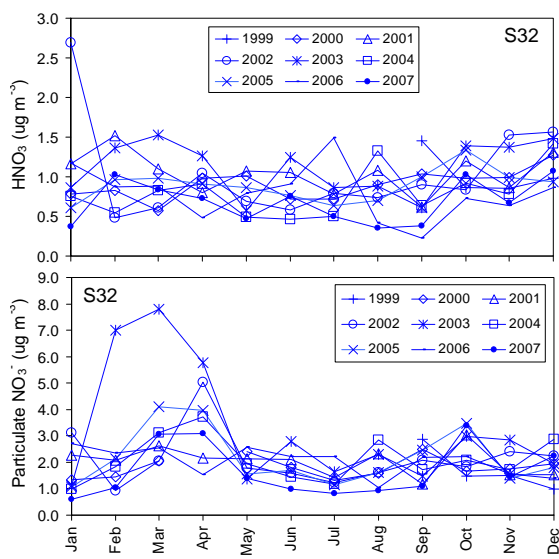
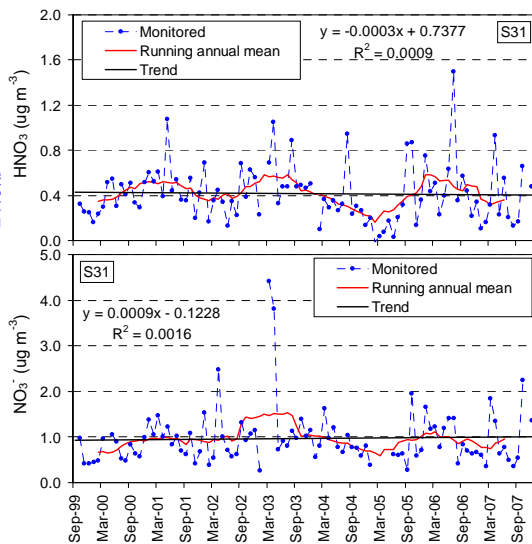

(vi) High Muffles

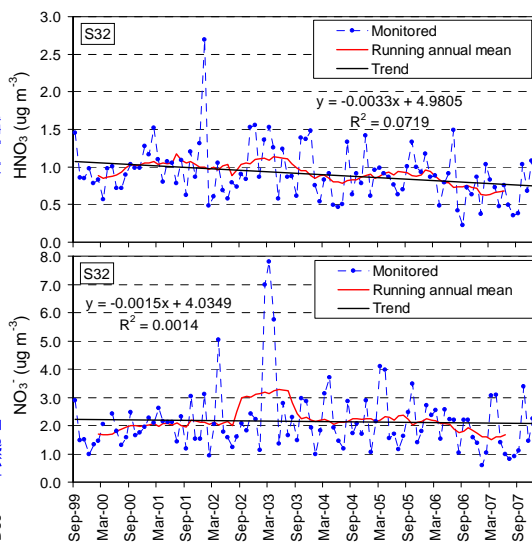

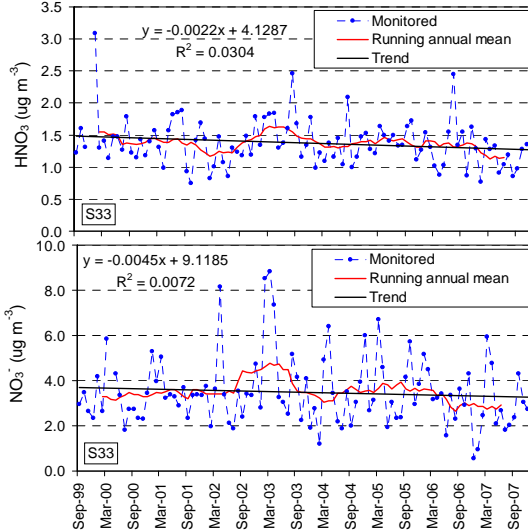
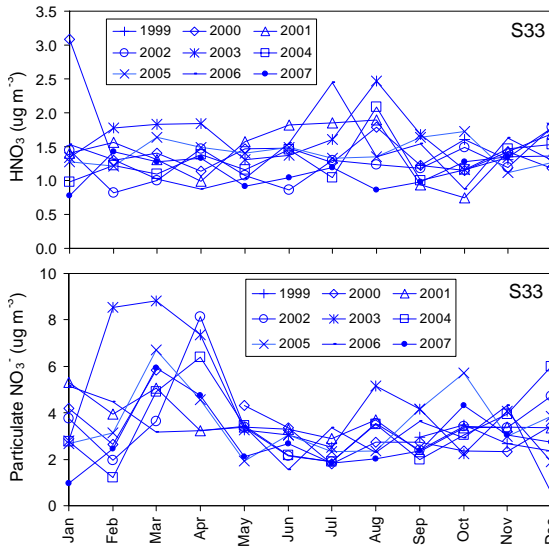

(vii) Stoke Ferry

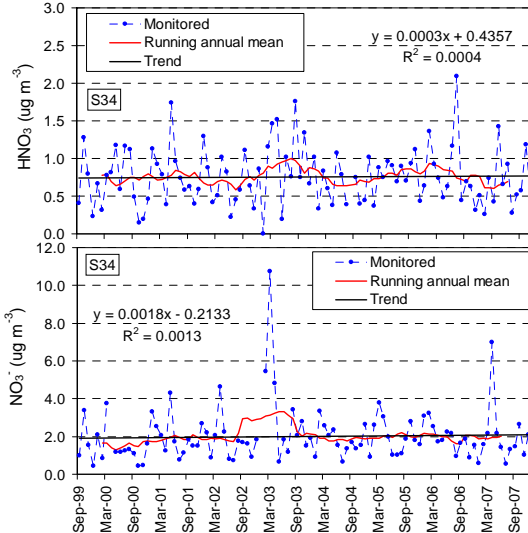
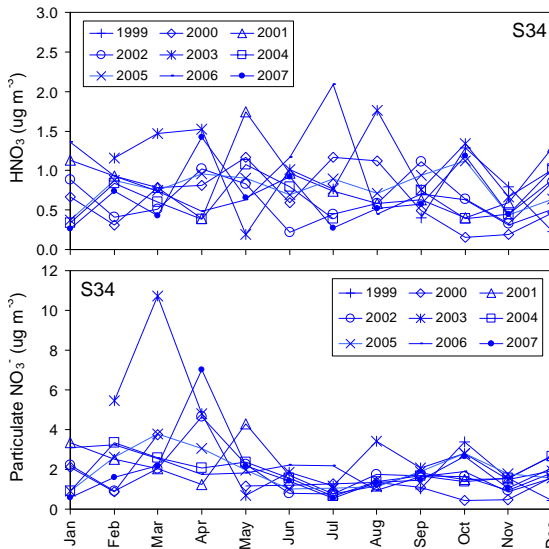

(viii) Yarner Wood

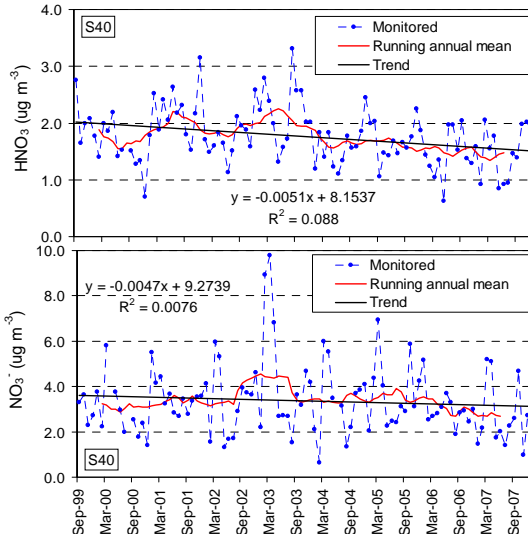
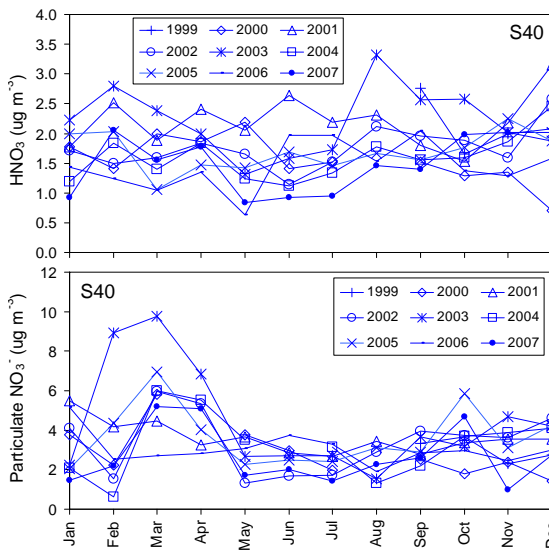

(ix) Sutton Bonington

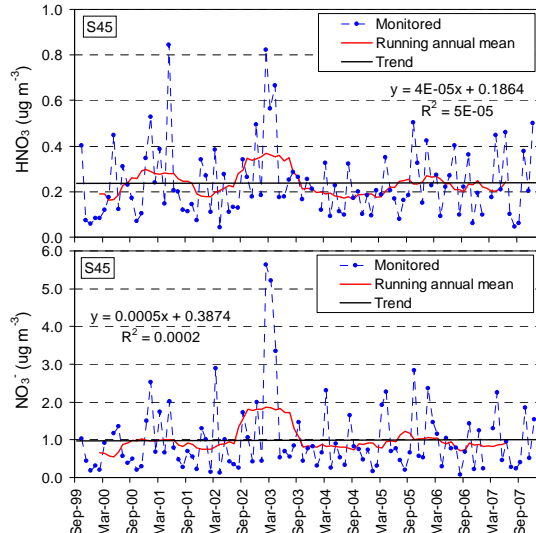
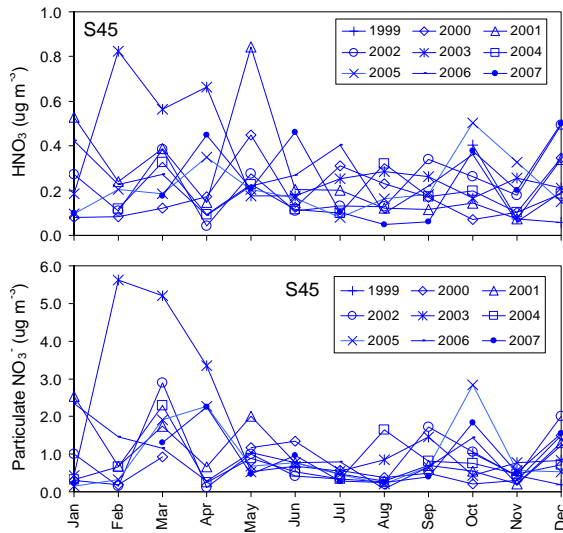

(x) Lough Navar

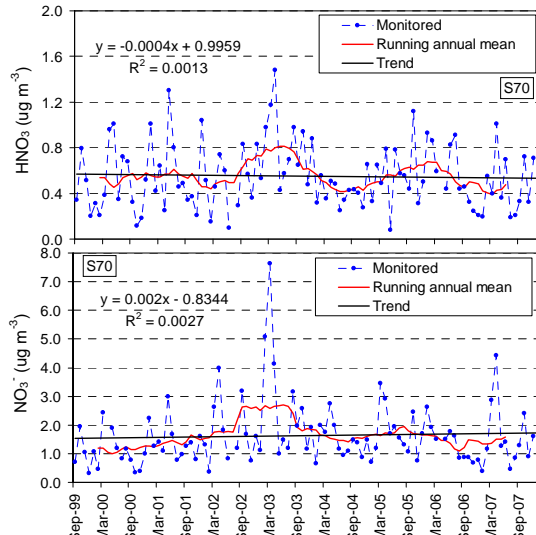
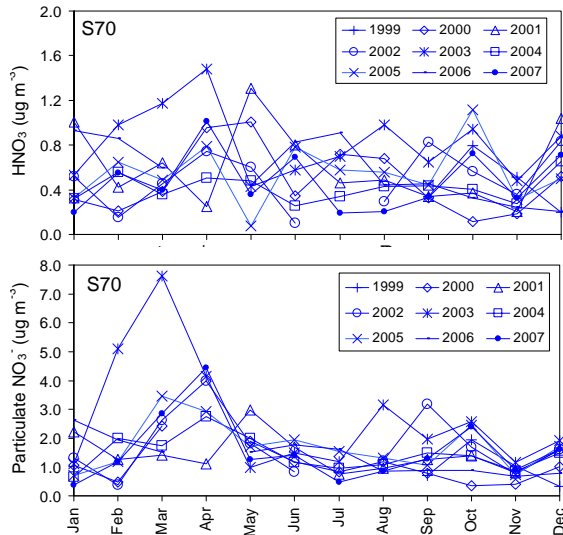

(xi) Cwmystwyth

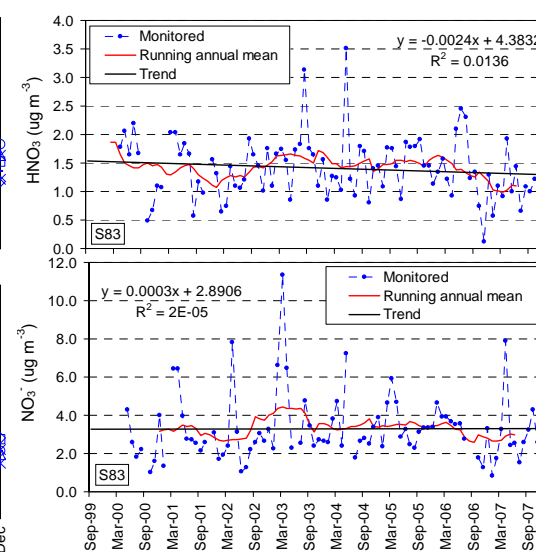
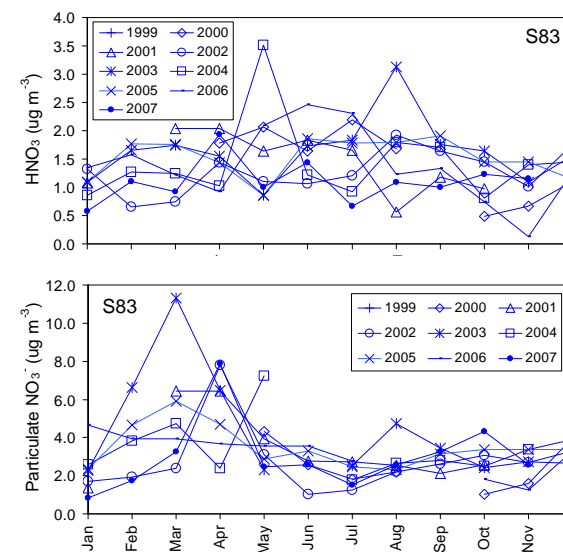

(xii) Barcombe Mills

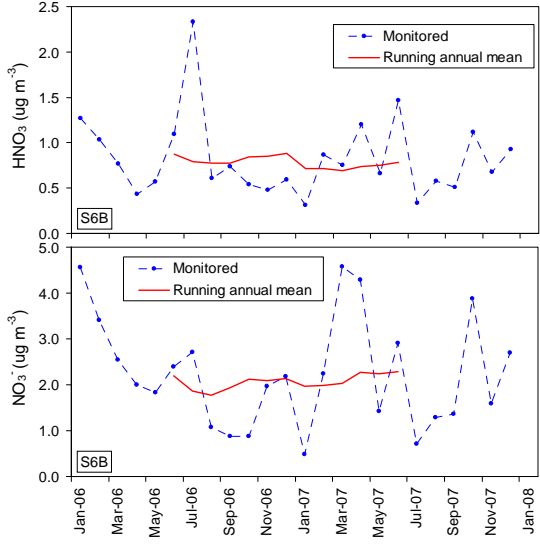
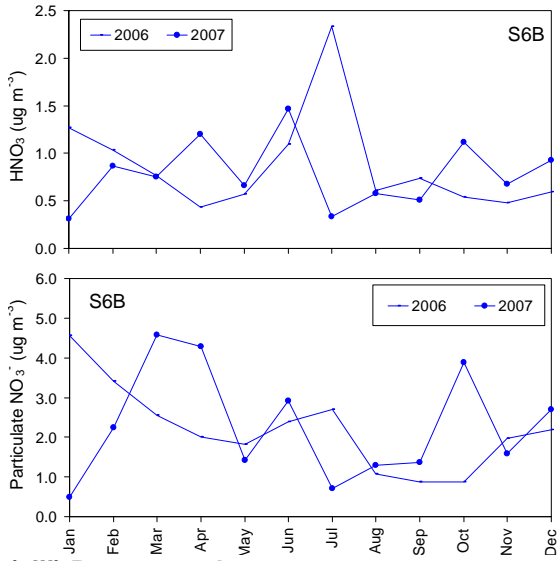

(xiii) Rosemaund

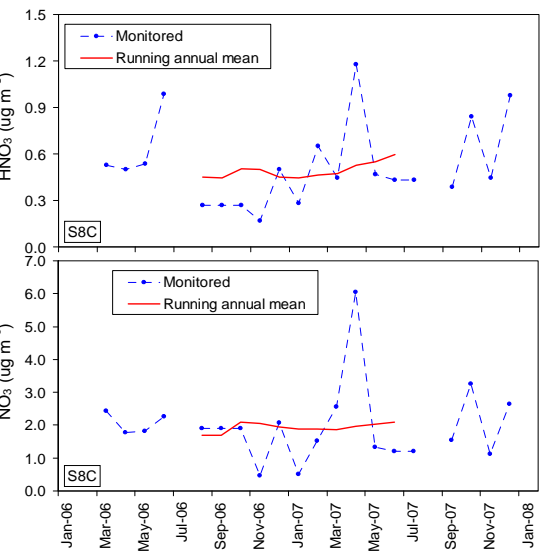
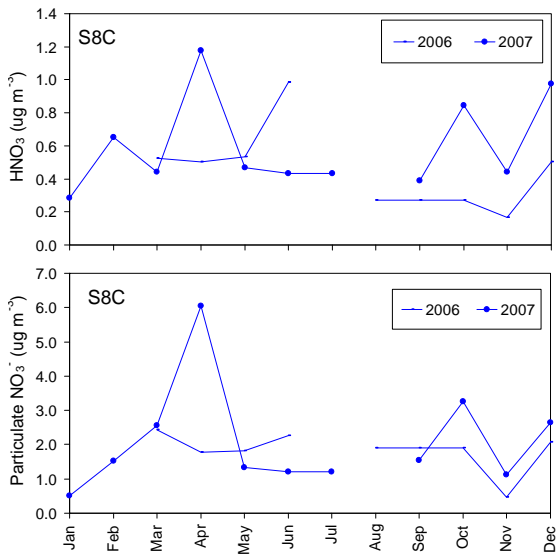

(xiv) Narberth

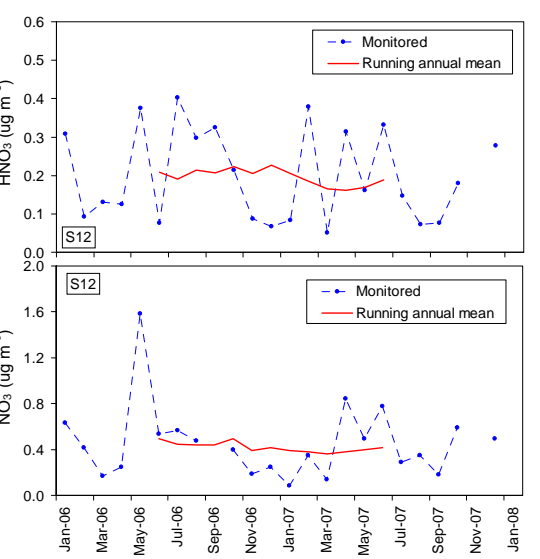
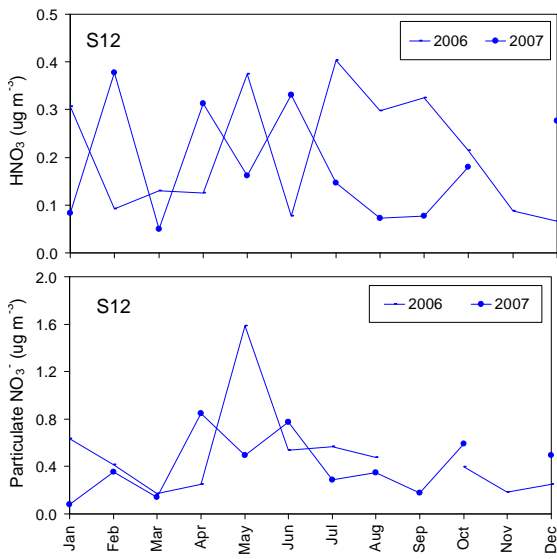

(xv) Halladale

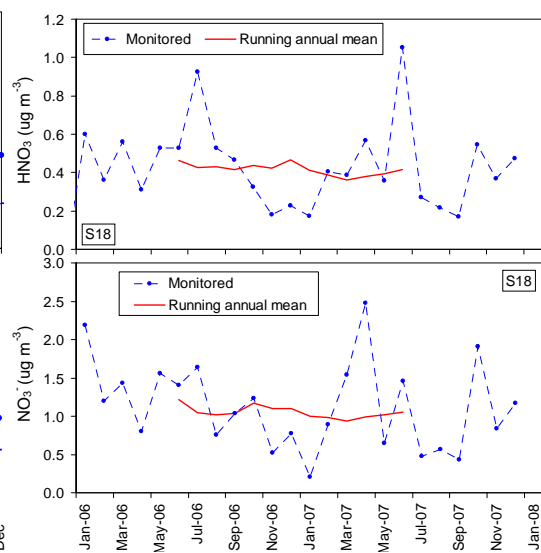
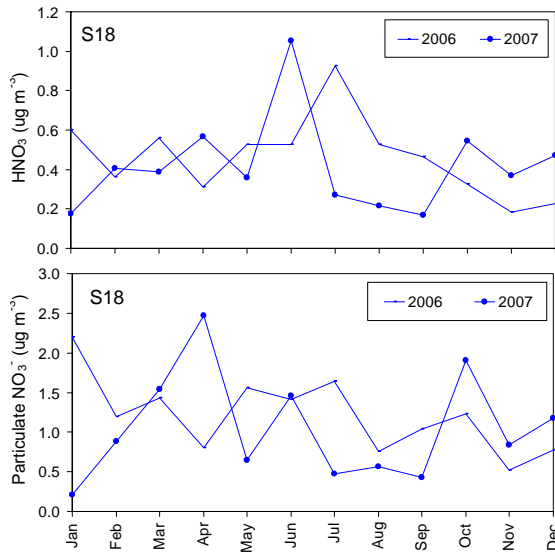

(xvi) Auchencorth

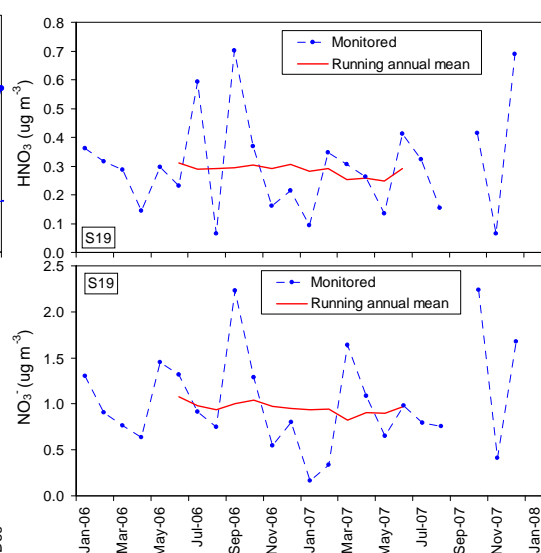
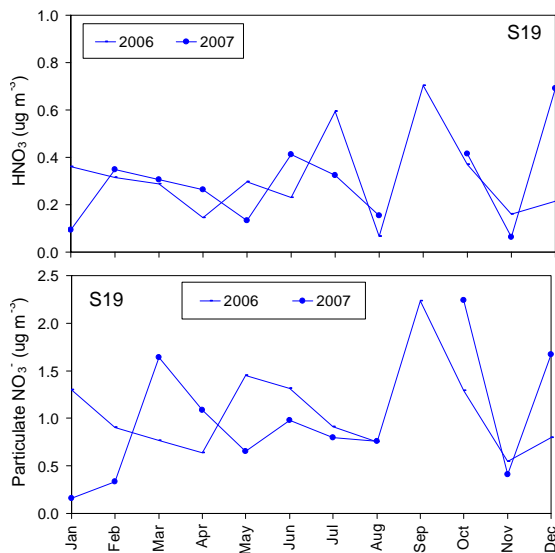

(vxii) Shetland

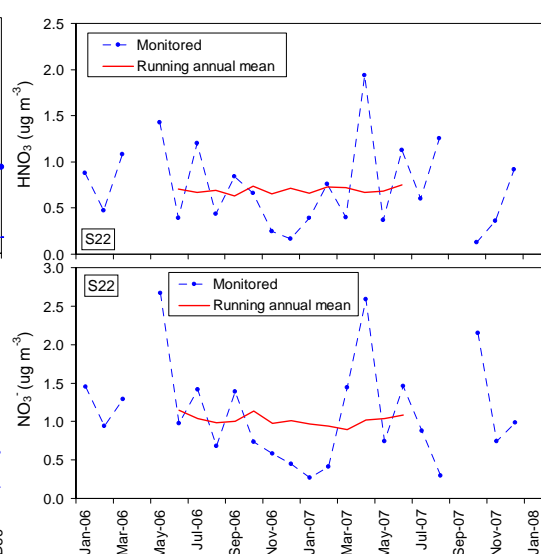
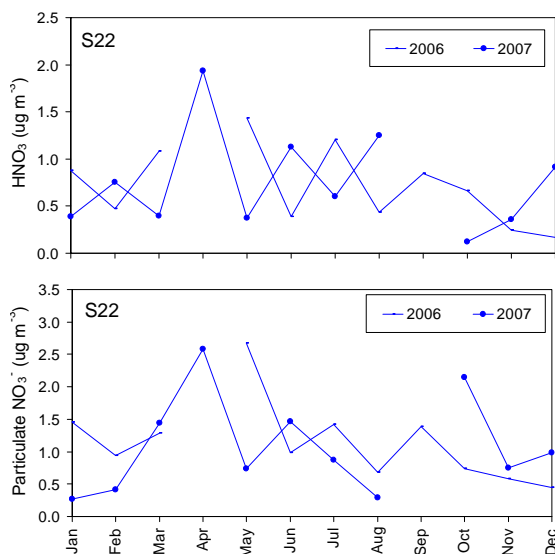

(xviii) Moorhouse



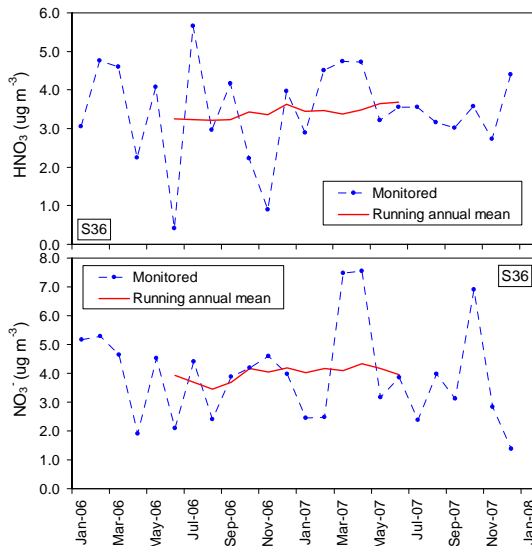
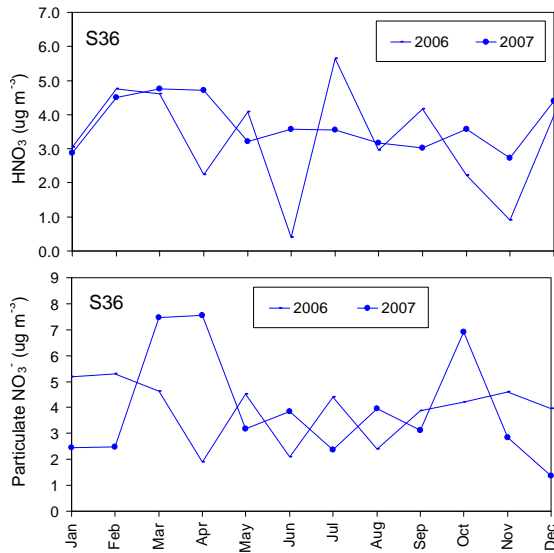

(xix) London

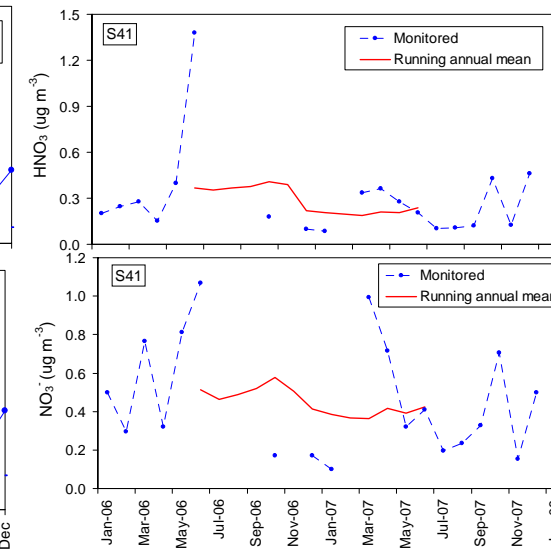
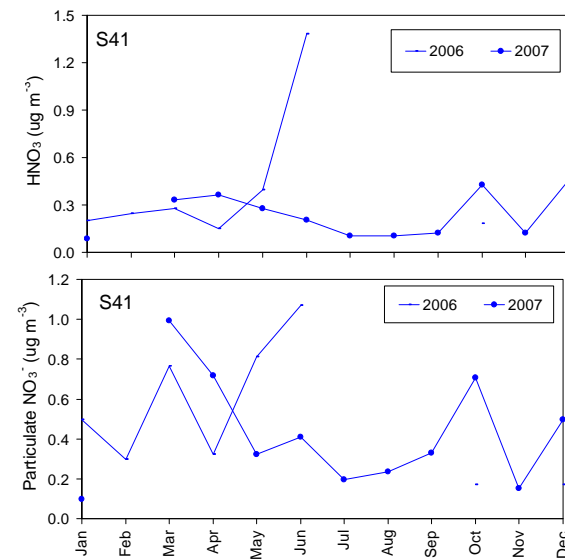

(xx) Lagganlia

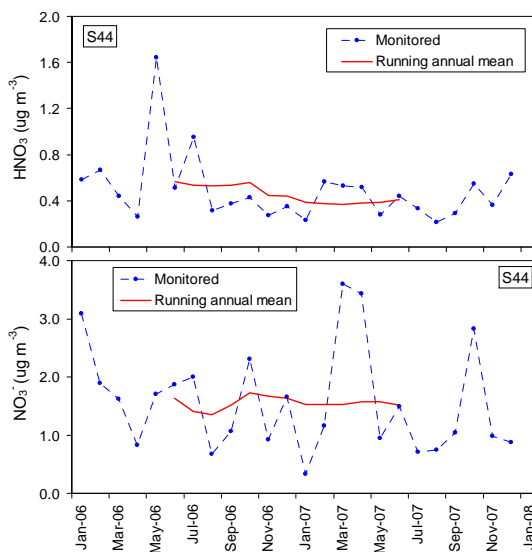
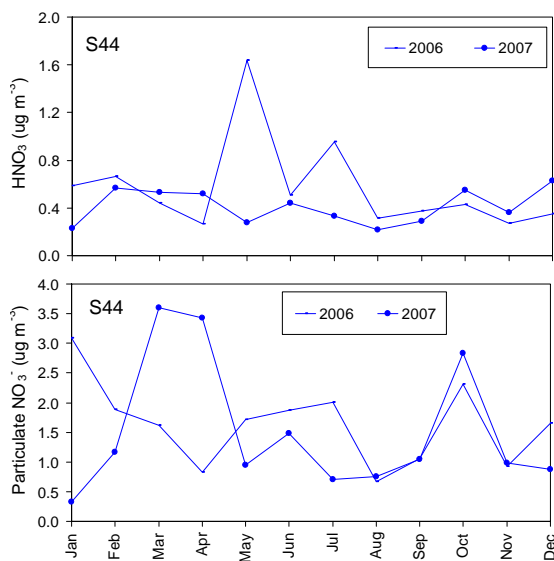

(xxi) Hillsborough



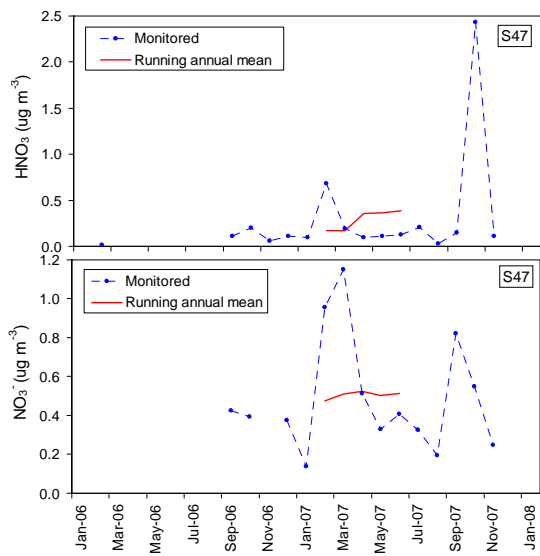
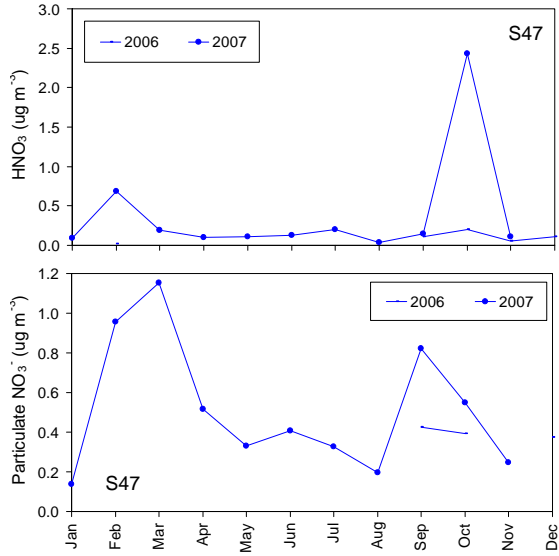

(xxii) Rum

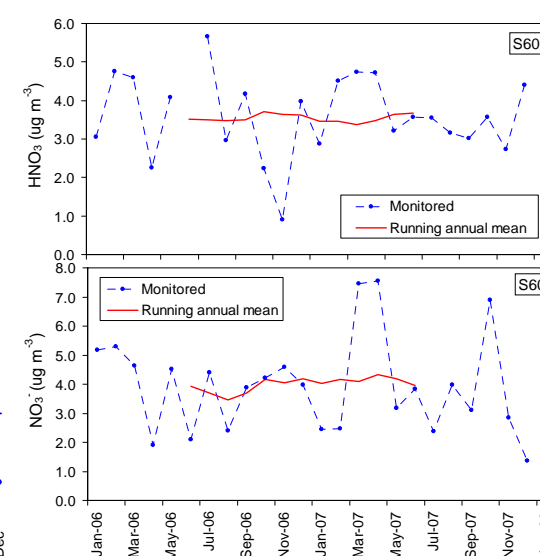
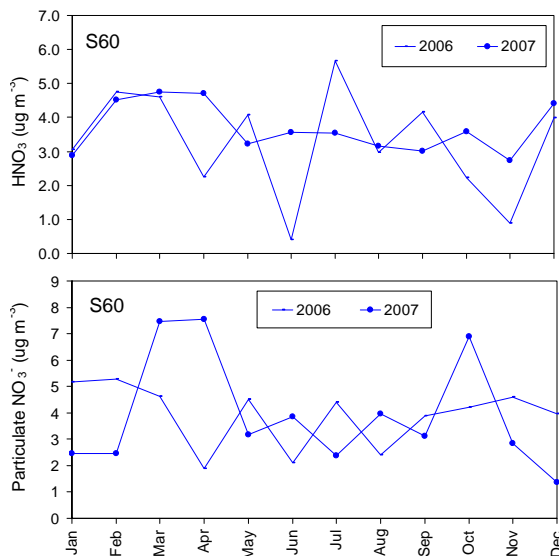

(xxiii) Edinburgh

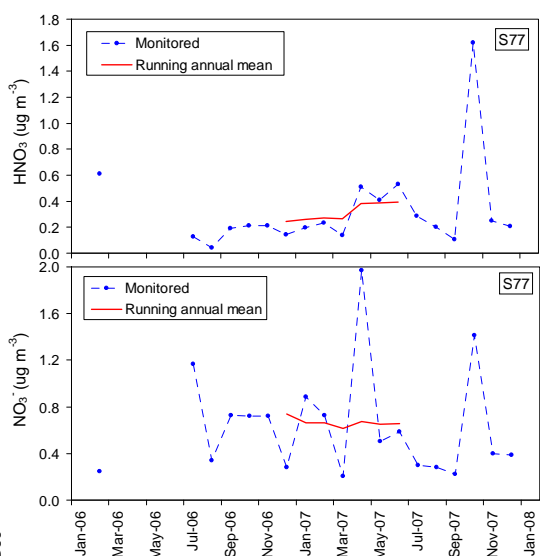
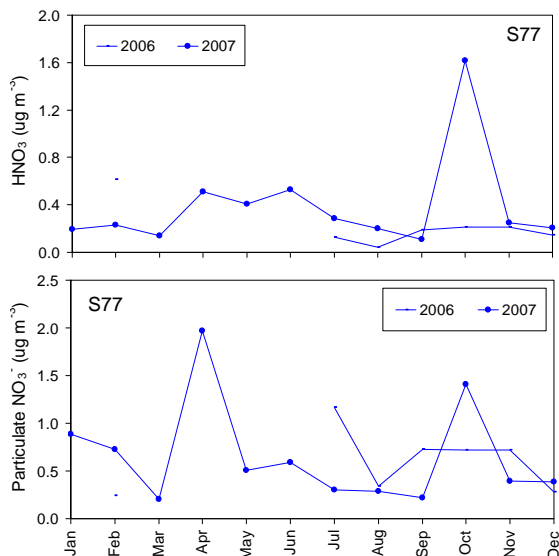

(xxiv) Carradale

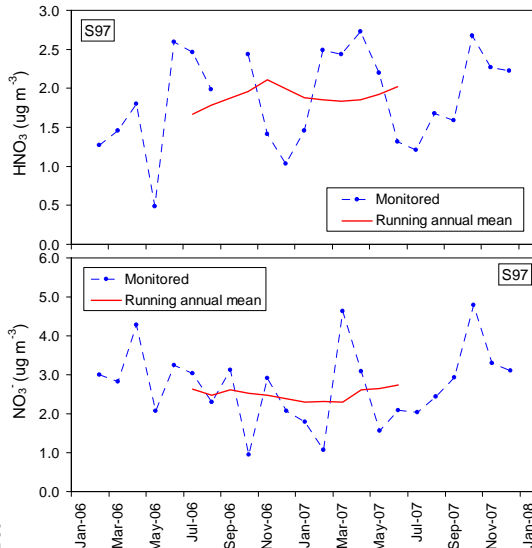
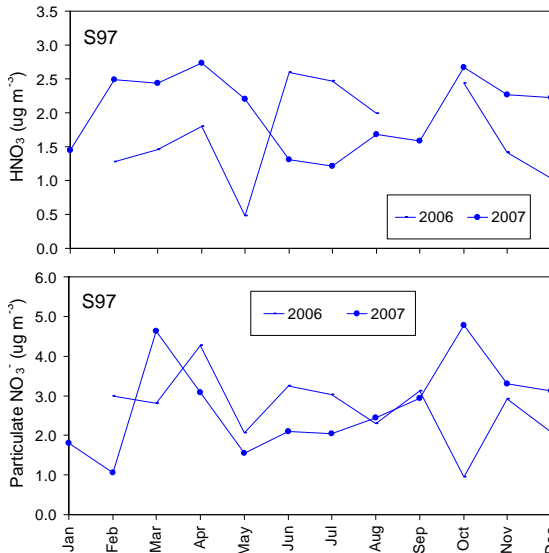

(xxv) Detling

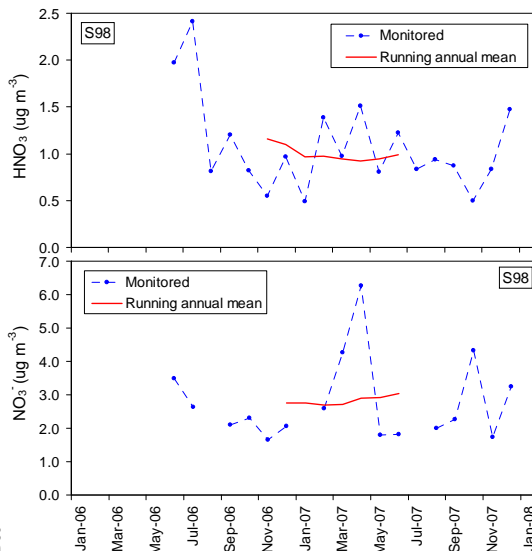
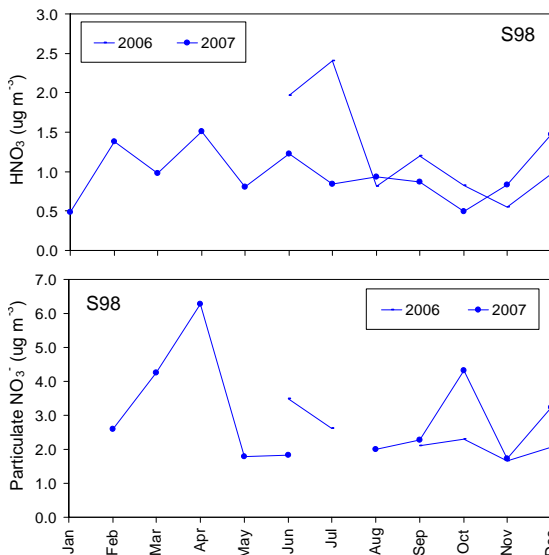

(xxvi) Harwell

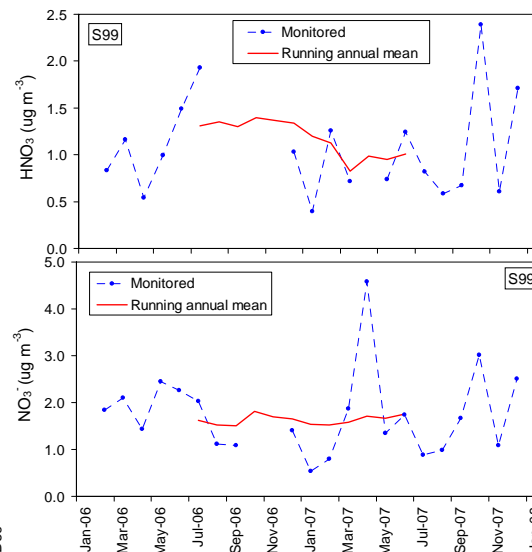
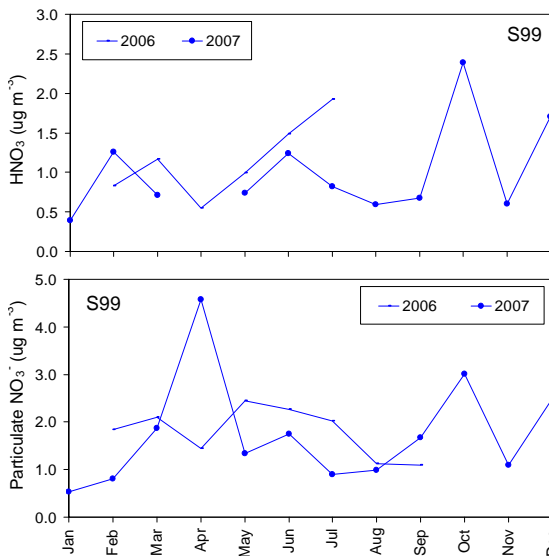

(xxvii) Ladybower

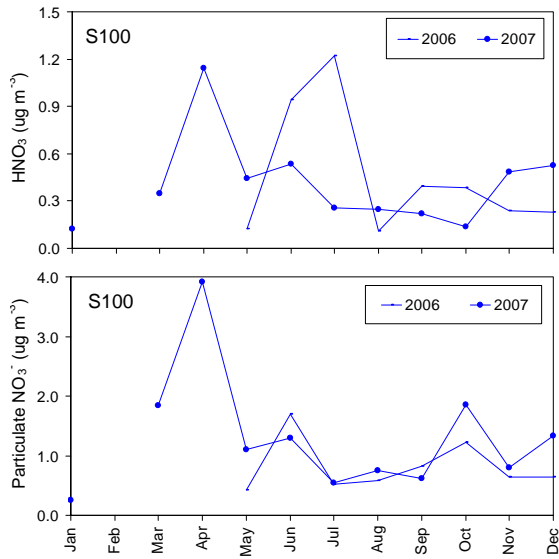

(xxviii) Plas Y Brenin

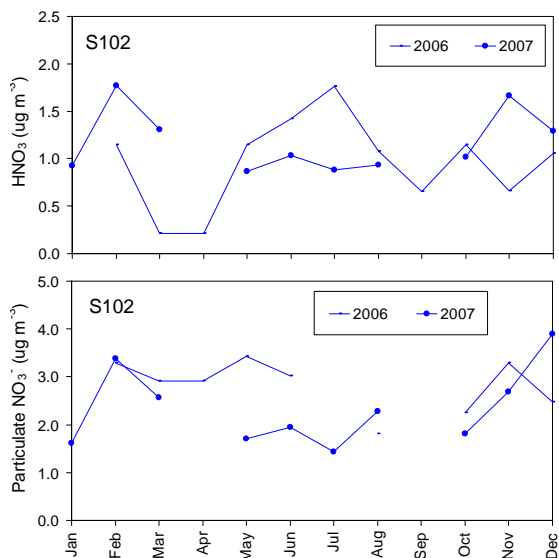
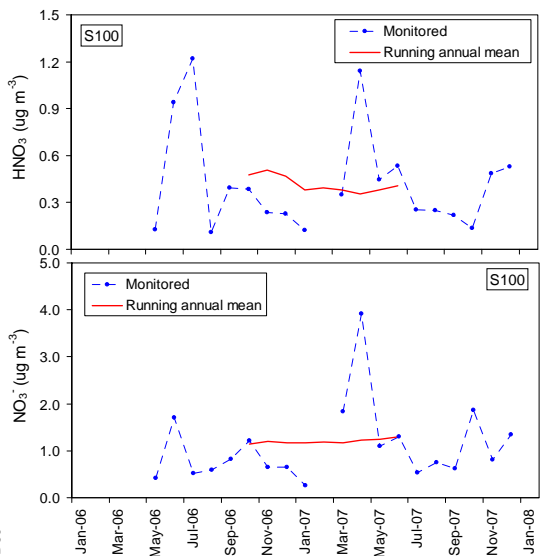

(xxix) Caenby

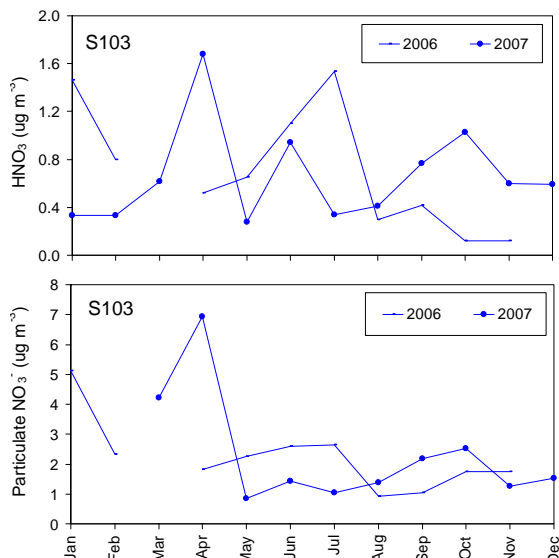
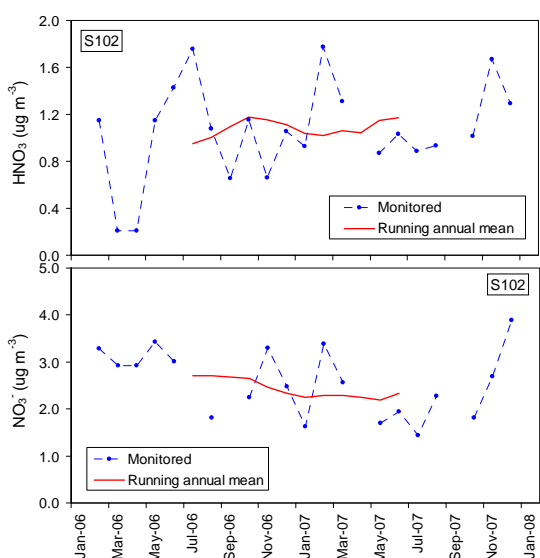

(xxx) Goonhilly

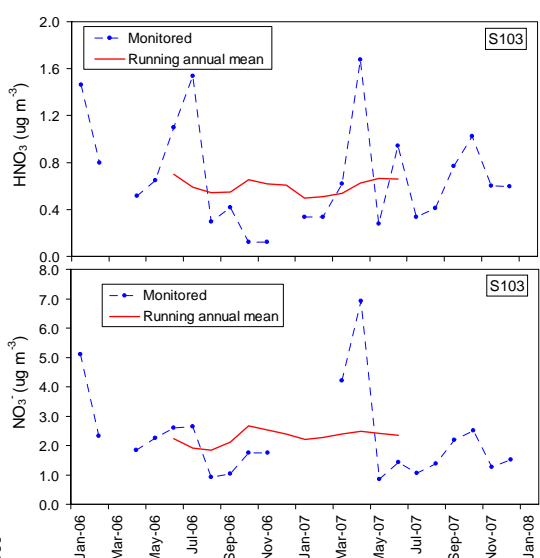

Appendix A5.5 Monthly measurements of gaseous SO<sub>2</sub> and aerosol SO<sub>4</sub><sup>2-</sup>

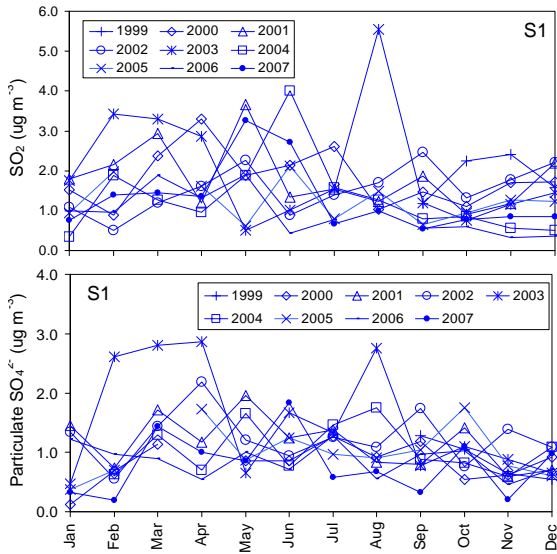

(i) Bush OTC

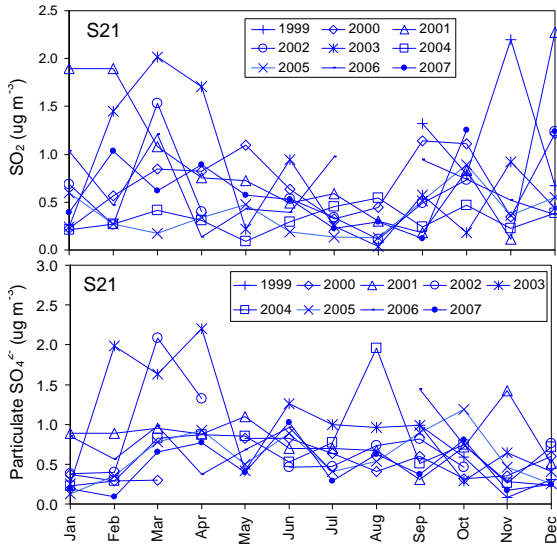
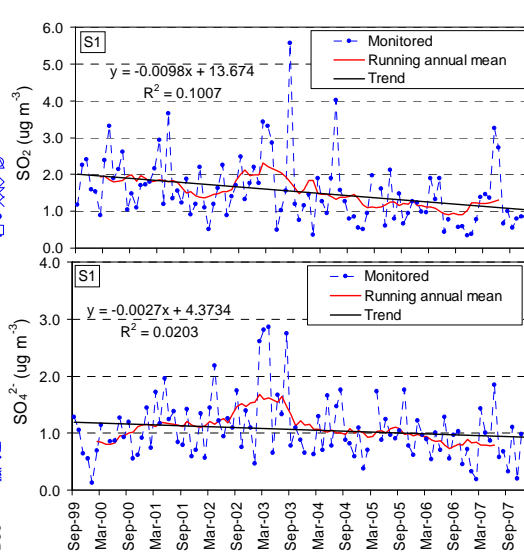

(ii) Glensagh

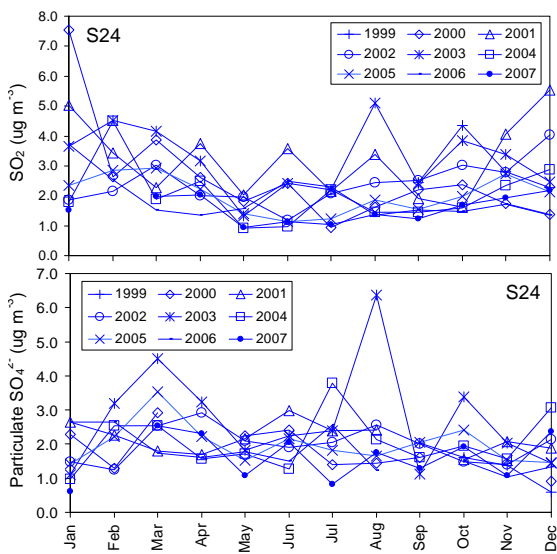
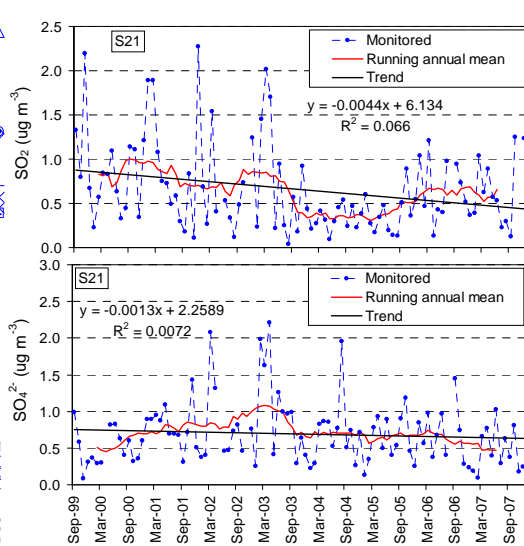

(iii) Rothamsted

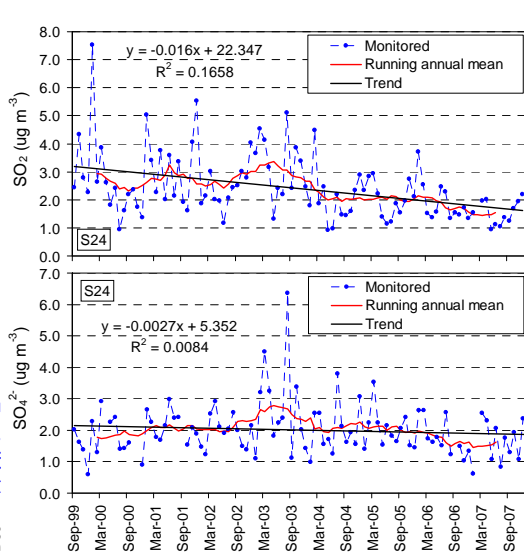

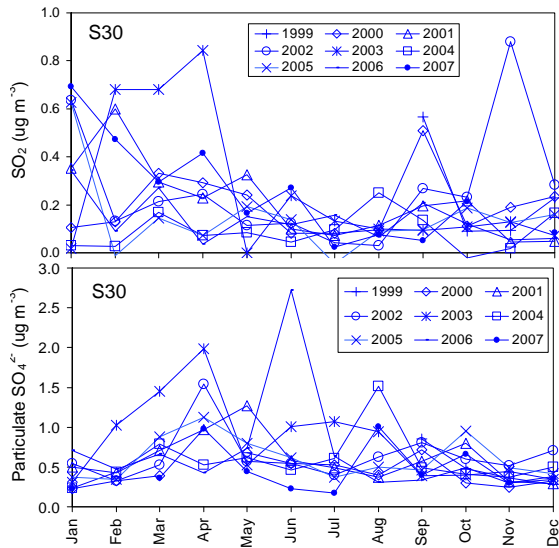

(iv) Strathvaich Dam

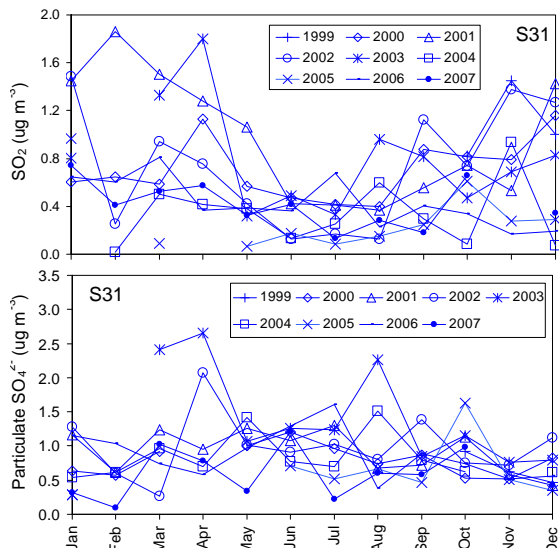
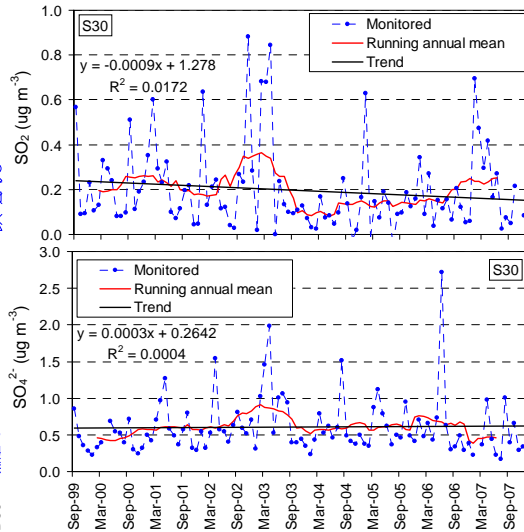

(v) Eskdalemuir

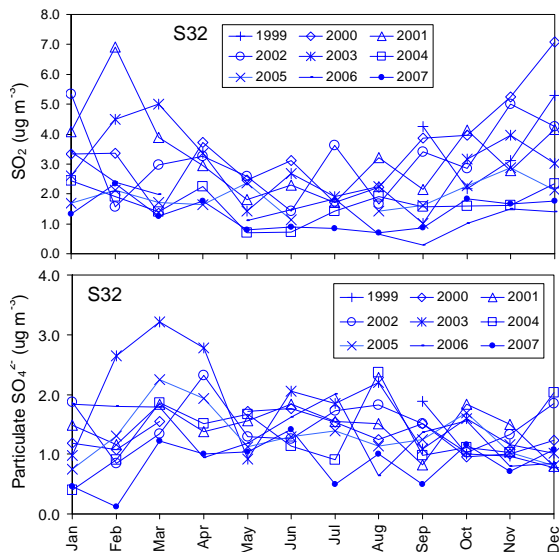
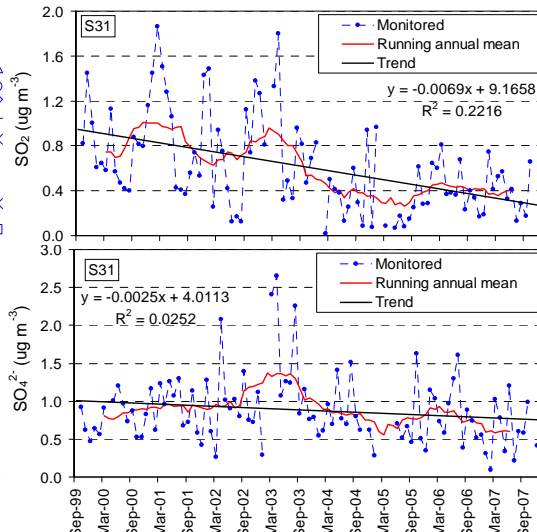

(vi) High Muffles

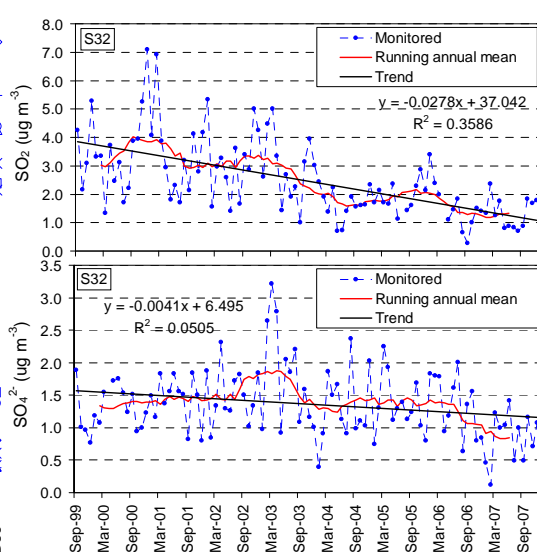

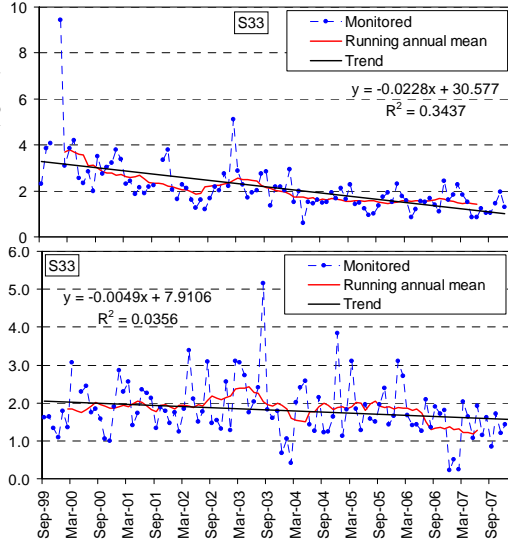
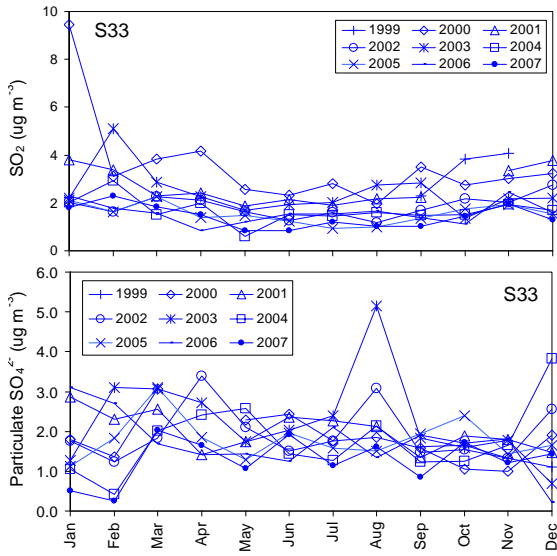

(vii) Stoke Ferry

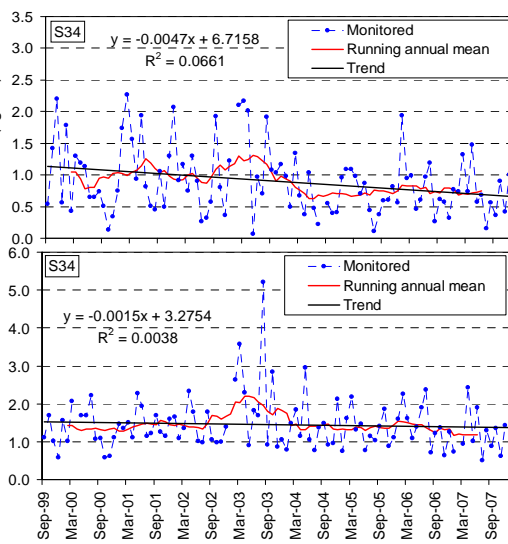
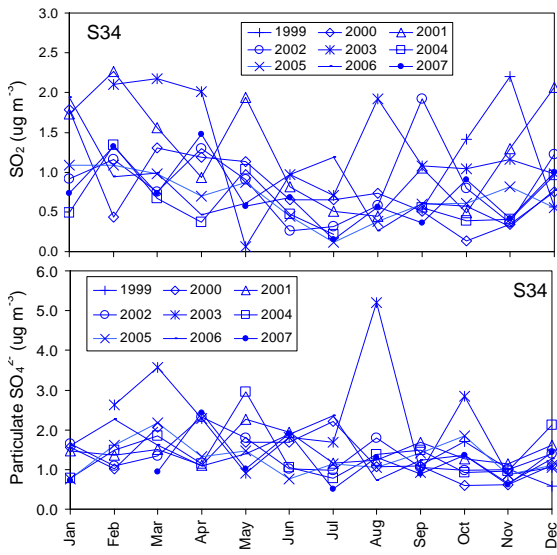

(viii) Yarner Wood

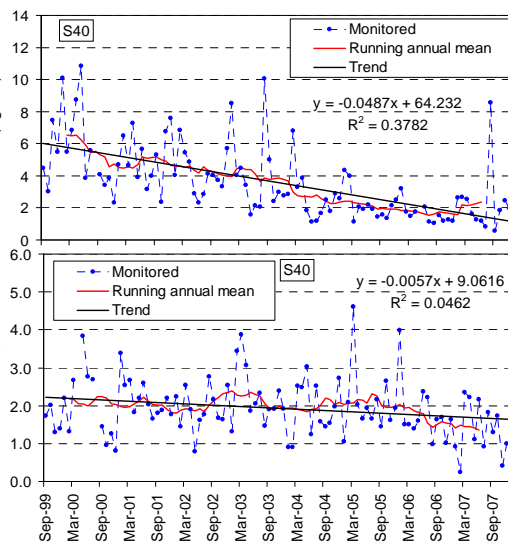
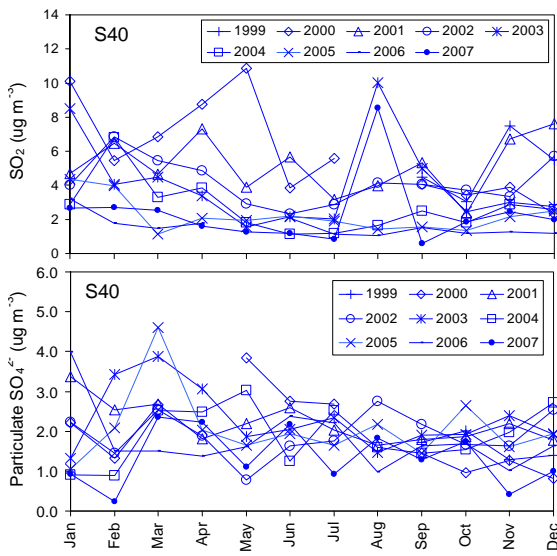

(ix) Sutton Bonington

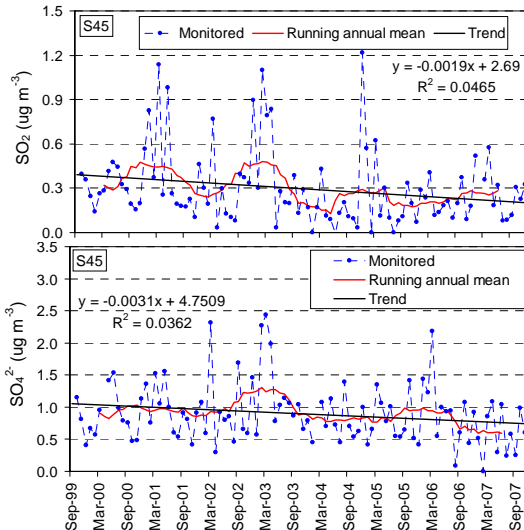
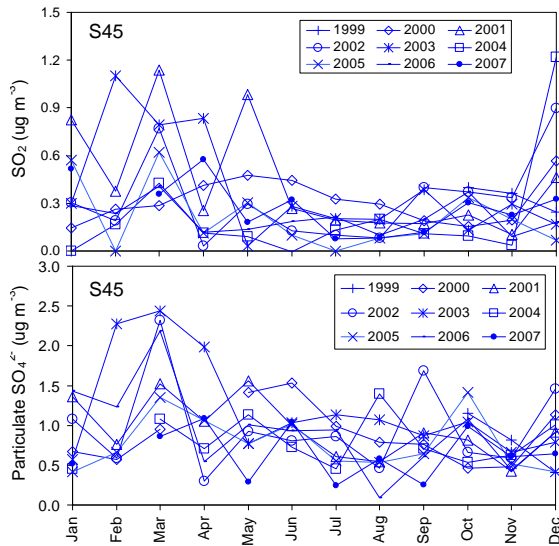

**(x) Lough Navar**

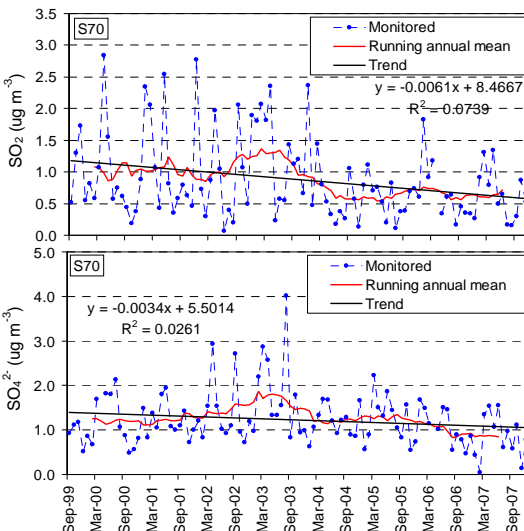
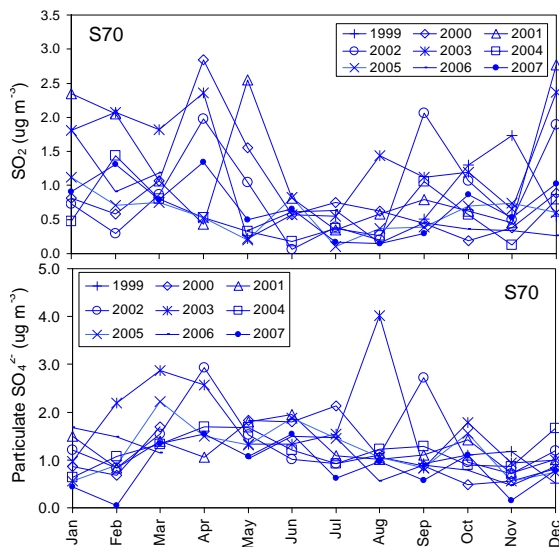

**(xi) Cwmystwyth**

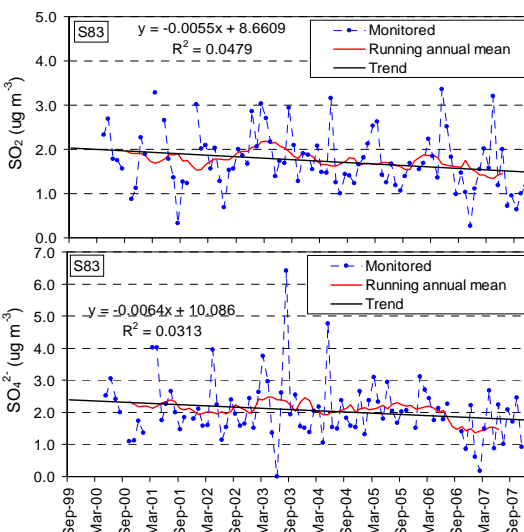
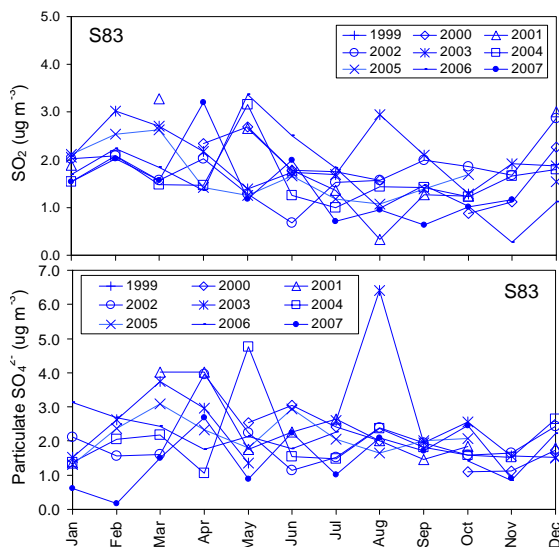

**(xii) Barcombe Mills**

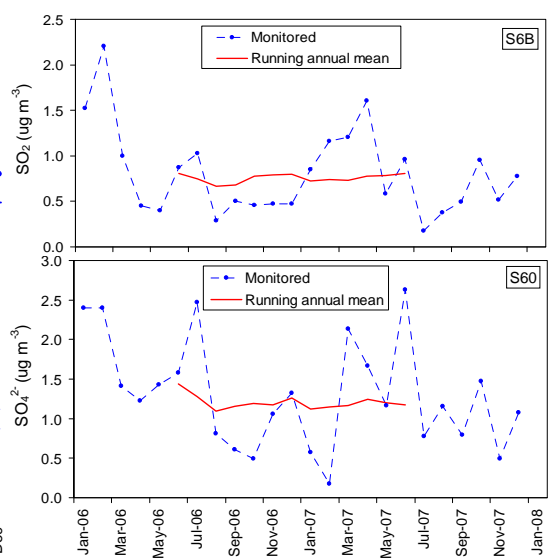
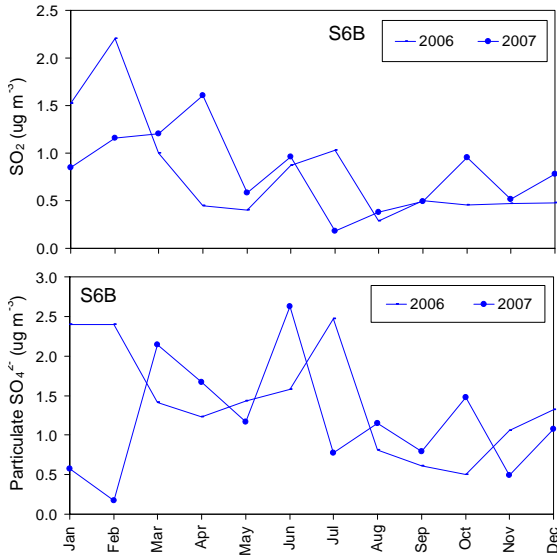

**(xiii) Rosemaund**

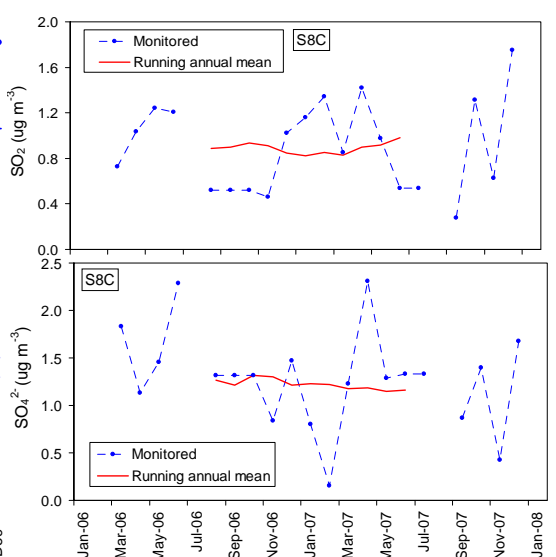
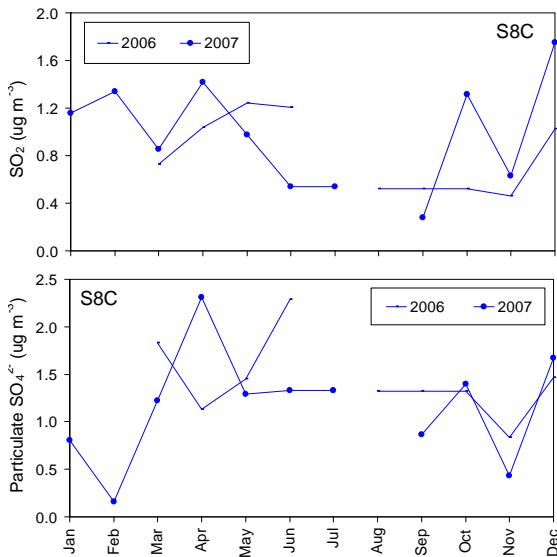

**(xiv) Narberth**

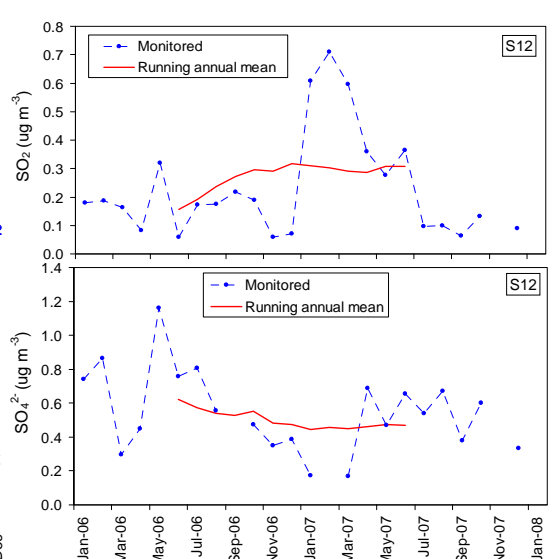
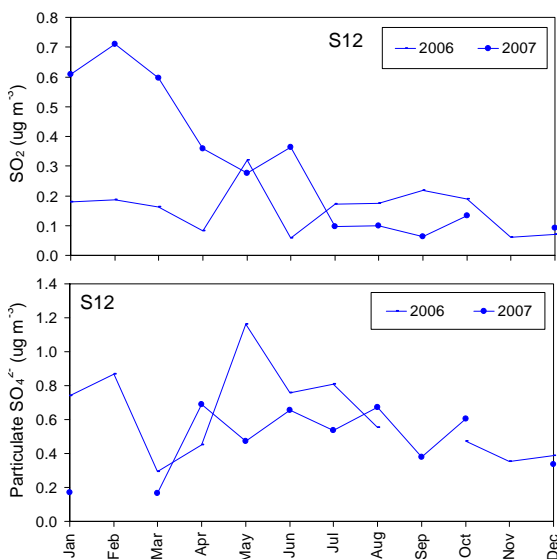

**(xv) Halladale**



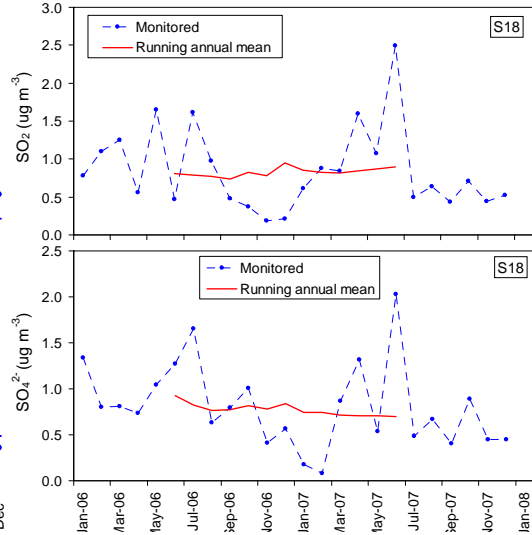
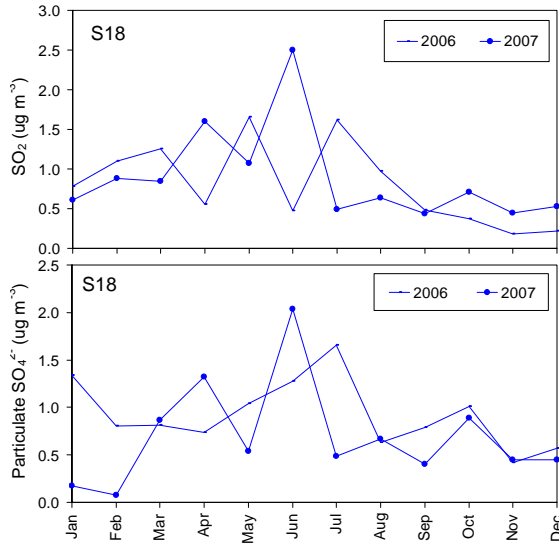

(xvi) Auchencorth

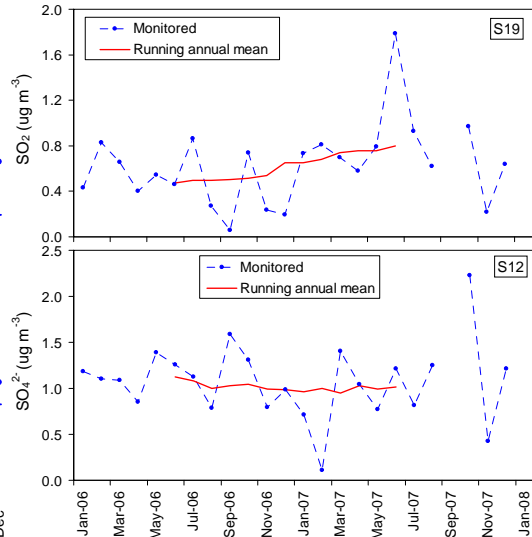
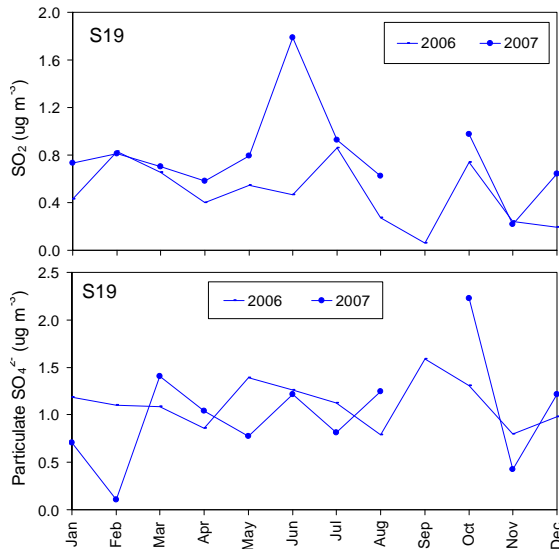

(xvii) Shetland

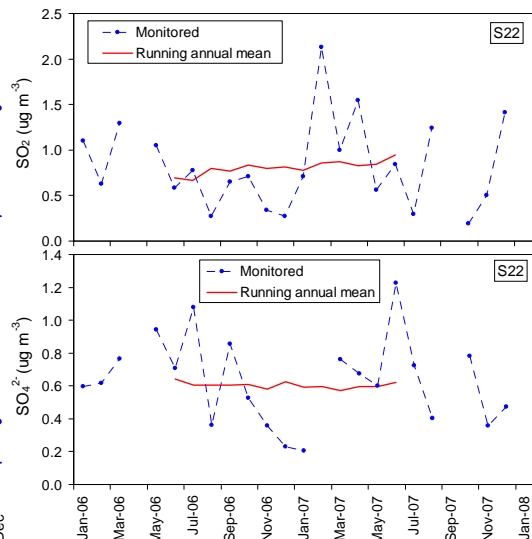
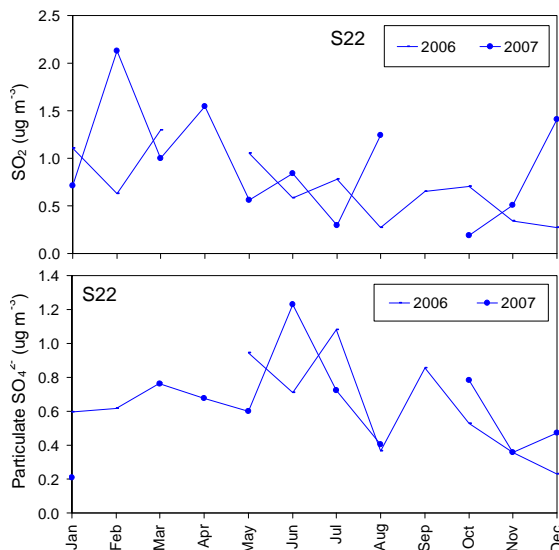

(xviii) Moorhouse

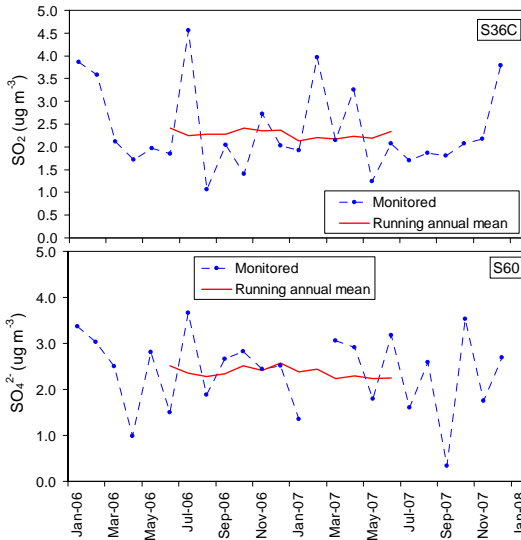
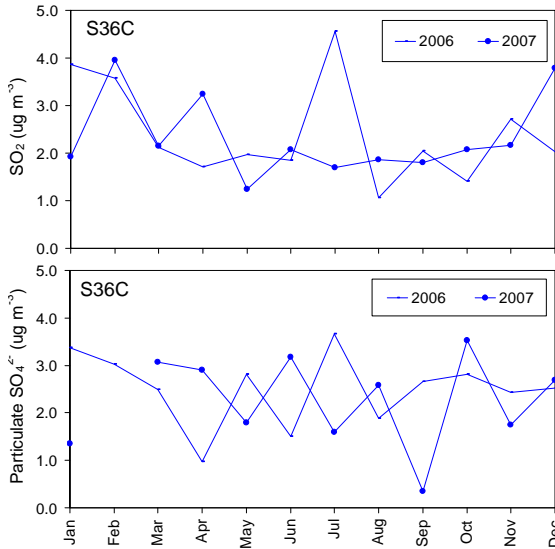

(xix) London

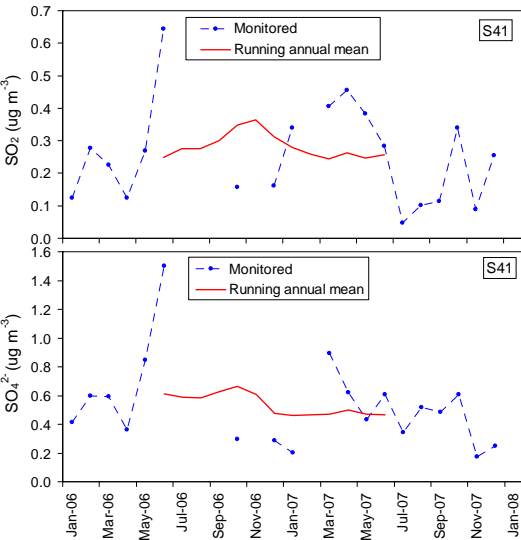
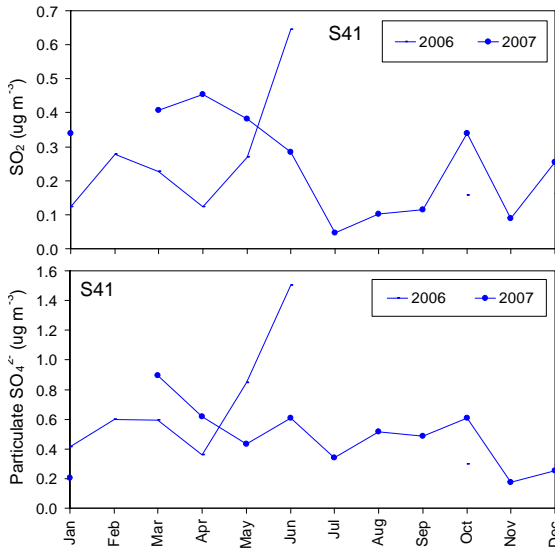

(xx) Lagganlia

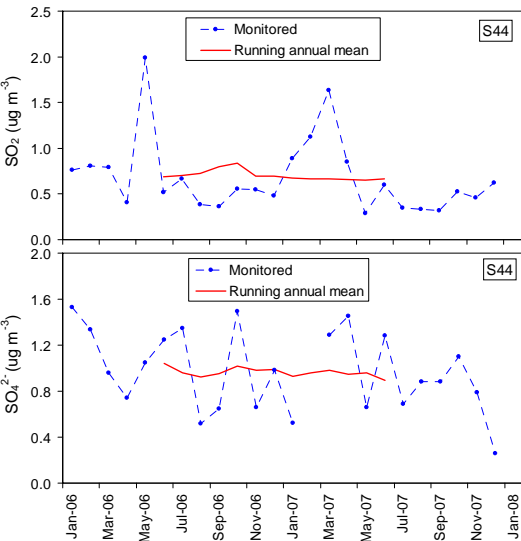
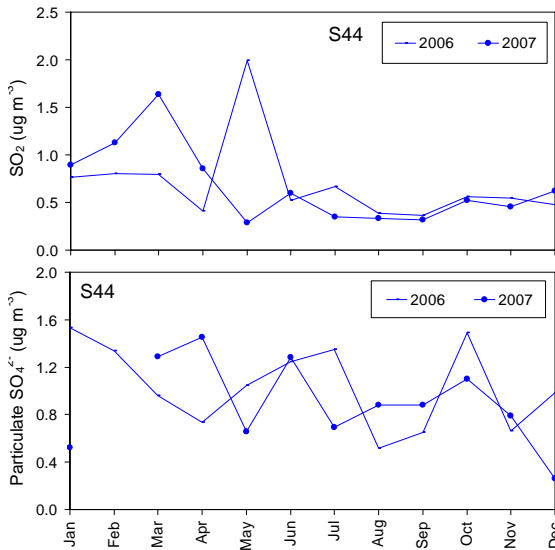

(xxi) Hillsborough

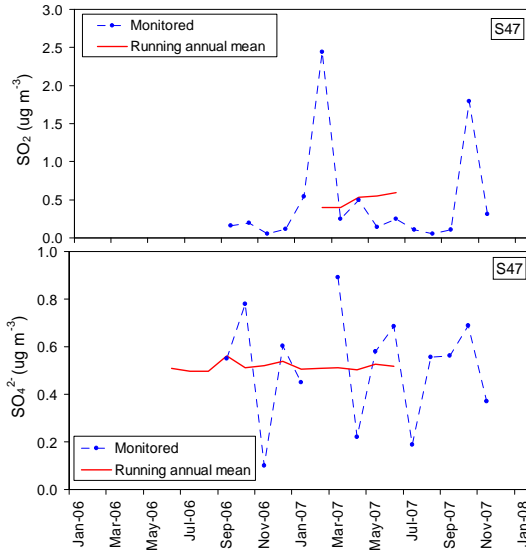
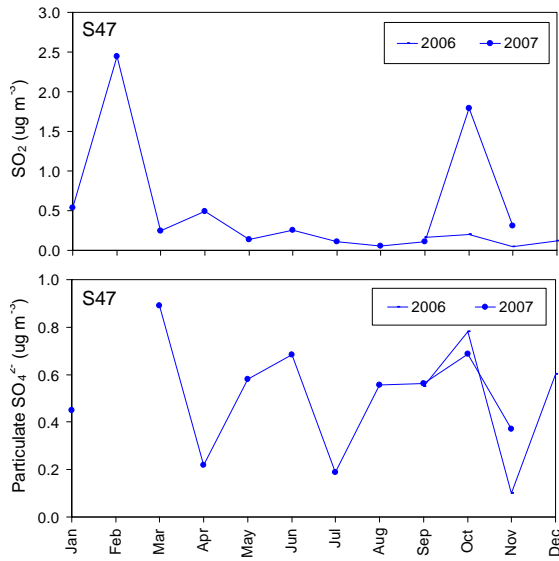

**(xxii) Rum**

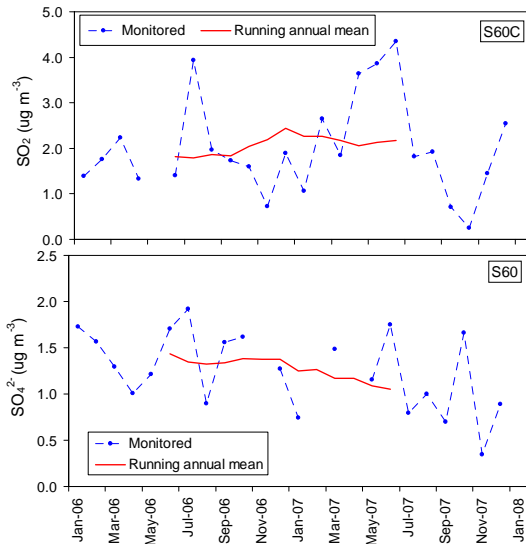
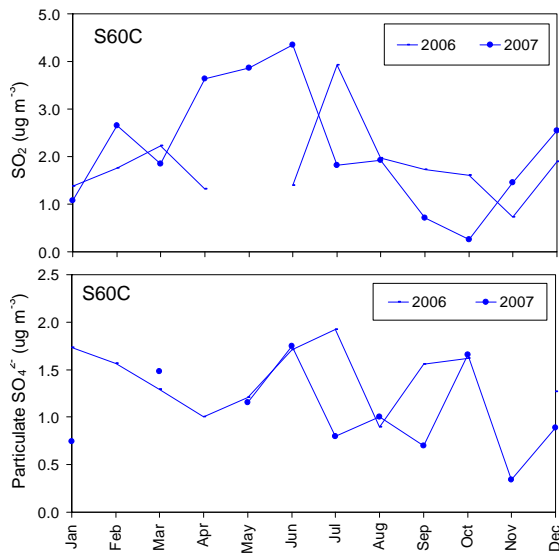

**(xxiii) Edinburgh**

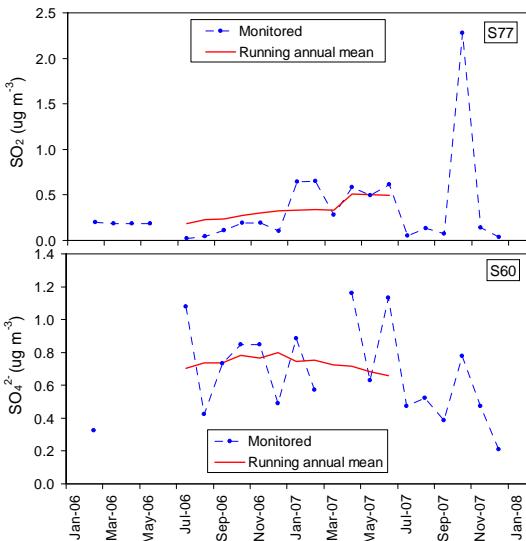
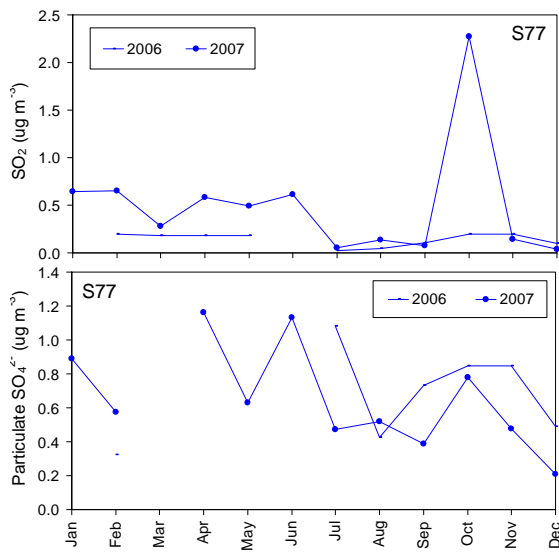

**(xxiv) Carradale**

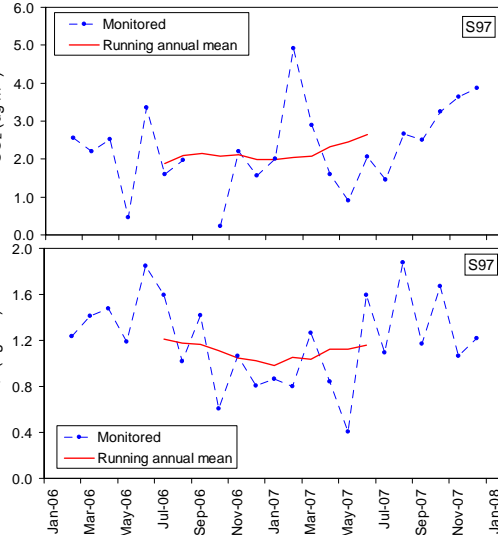
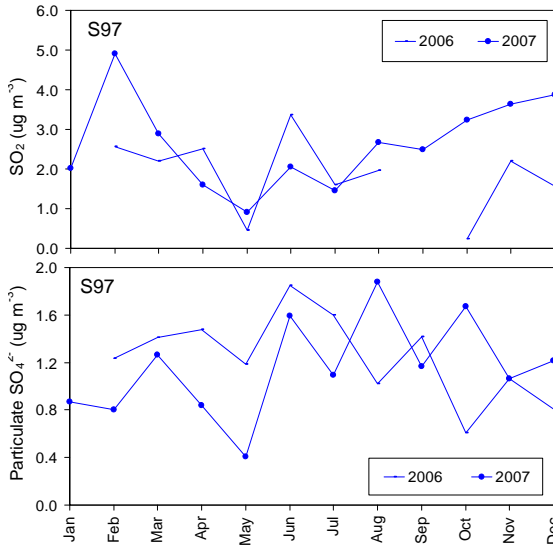

(xxv) Detling

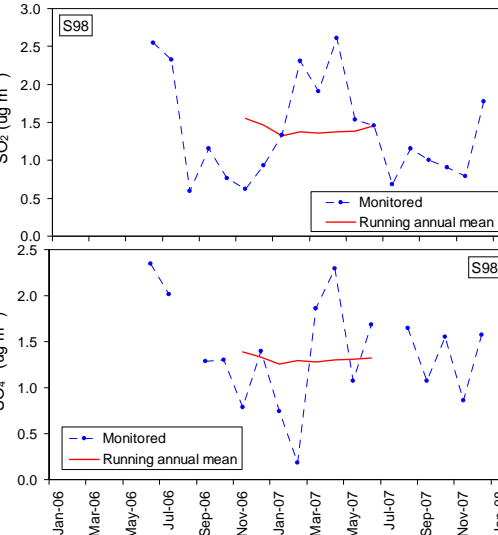
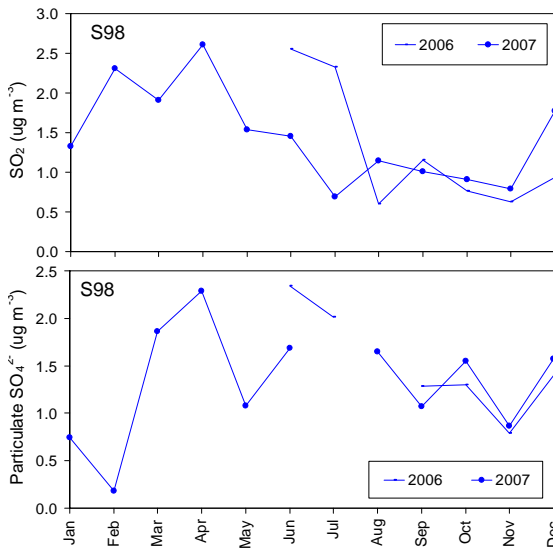

(xxvi) Harwell

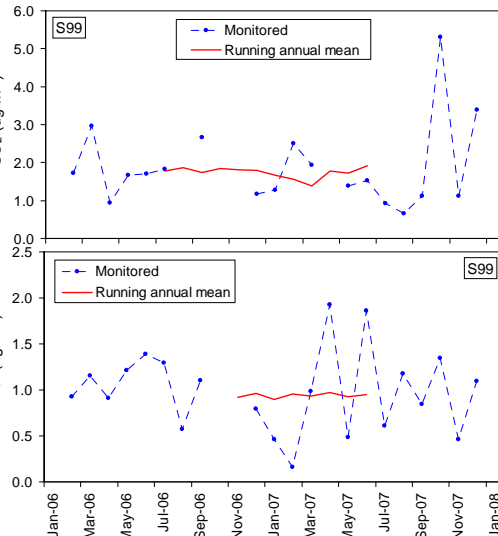
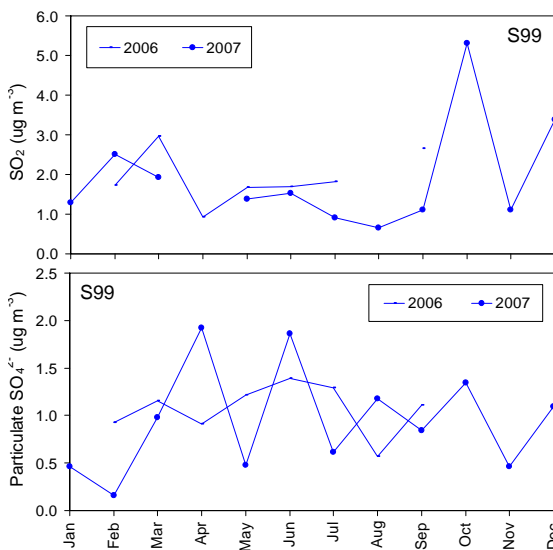

(xxvii) Ladybower

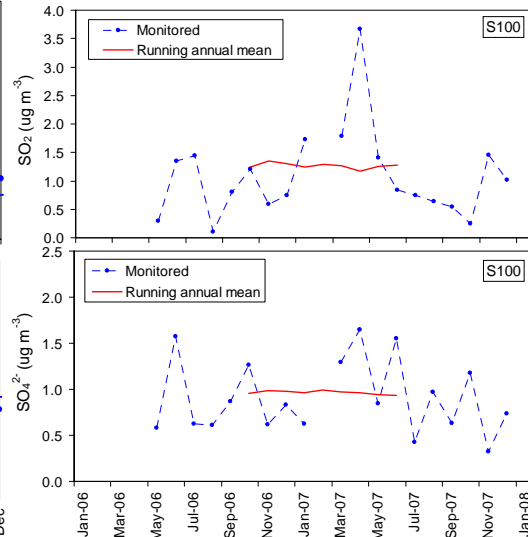
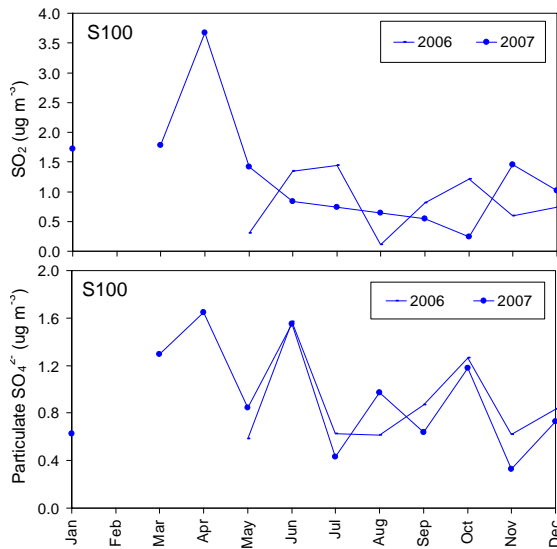

(xxviii) Plas Y Brenin

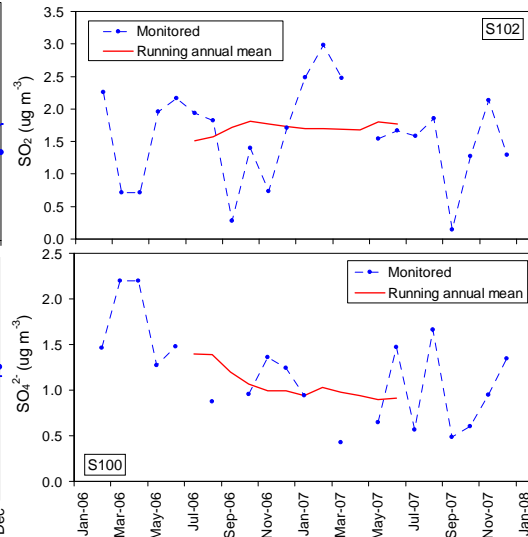
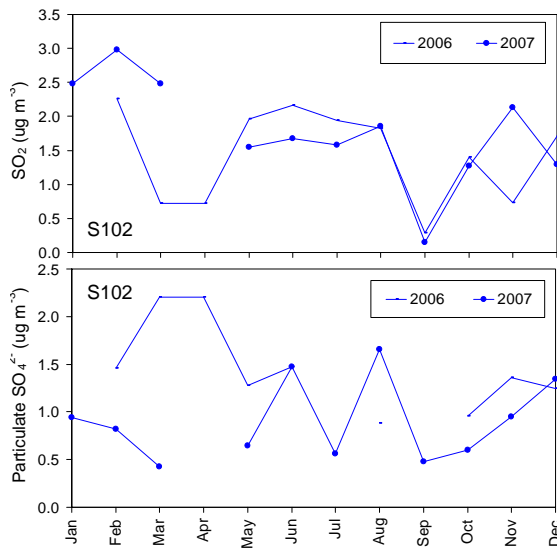

(xxix) Caenby

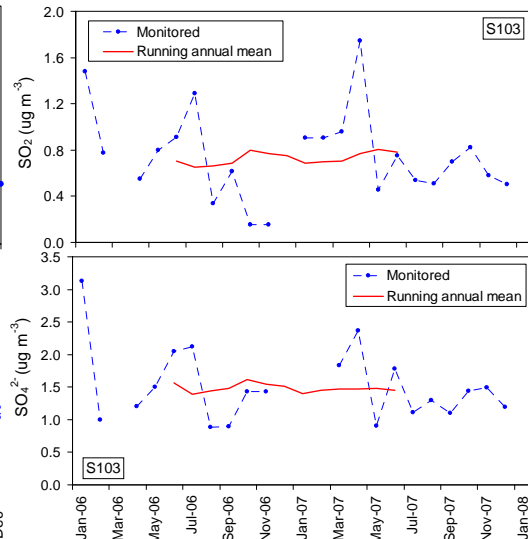
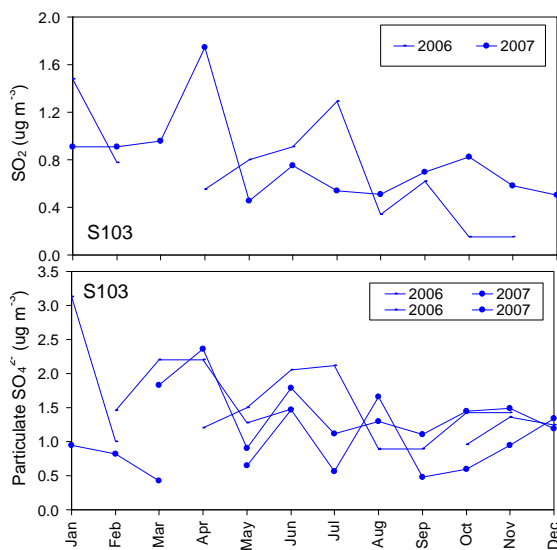

(xxx) Goonhilly



## Appendix 6

### Geostatistics

The use of geostatistics in the analysis of United Kingdom precipitation composition has been described by Webster *et al.* (1991). A brief discussion is reproduced here. In a geostatistical treatment of spatial variability, the concentration of an ion in precipitation, averaged over a time period of one year, is treated as a regionalised random variable. It is assumed that the values at the sites are drawn from the distribution of a random variable with a constant mean. The variance, however, depends on the separation of the sites. For example, within one 20 km x 20 km grid square the variance would probably be smaller than within a 200 km x 200 km square. The dependence of the variance on separation (usually termed the lag) is described by a quantity known as the semi-variance:

$$\gamma(h) = \frac{\sum(z_1 - z_2)^2}{2n} \quad [1]$$

Where there are  $n$  pairs of data  $z_1, z_2$  separated by a distance  $h$ . A plot of the semi-variance against lag is called a **variogram**.

It can be shown that the variogram function (usually termed the variogram model) must be selected from one of a few allowed forms, each of which has one or more variable parameters that must be fitted to the experimental data. Models that are allowed are:

#### Exponential

$$\gamma(h) = c_0 + c_1 (1 - e^{-h/a}) \quad [2]$$

#### Spherical

$$\gamma(h) = c_0 + \frac{c_1}{2} \left\{ \frac{3h}{a} - \left( \frac{h}{a} \right)^3 \right\} \quad [3]$$

#### Linear

$$\gamma(h) = c_0 + \omega h^\theta \quad [4]$$

The parameter  $c_0$ , known as the “nugget”, is the residual variance for collocated measurements and is a result of measurement error or variability on a scale smaller than the separation of the measurement sites. The “range”,  $a$ , is a measure of the separation beyond which the measurements are uncorrelated, and the “sill”,  $c_0 + c_1$ , is the maximum semi-variance. The linear model applies when the regionalised variable has an unlimited capacity for spatial dispersion. There is no sill and the parameter  $\omega$  is called the factor and  $\theta$  the exponent.

Once a variogram model has been found it can be used in an interpolation procedure known as kriging to produce contour maps from irregularly spaced data. In the kriging process the interpolated value is expressed as a linear combination of the measured data  $I_1 z_1 + I_2 z_2 + \dots$ . Using the variogram model, the variance of the interpolated estimate can be expressed in terms of the  $I_i$  and this variance is then minimised subject to the constraint that the  $I_i$  sum to 1. The result is the best unbiased linear estimate in that it has the smallest error in the statistical sense. A further advantage of using kriging is that the interpolation variance is known for each interpolated estimate and this can be mapped along with the concentration to provide a measure of the reliability of the map.

The models fitted to the experimental points in the variogram for  $\log_e$  [acidity], non-marine sulphate, nitrate and ammonium are listed in Table A6-1.

<b>Table A6-1 – Variogram Models fitted to 2007 Annual Mean Concentrations of the Major Ions</b>			
Ion	Model	Sill ( $\mu\text{eq l}^{-1}$ ) <sup>2</sup>	Range (km)
Acidity ( $\log_e$ transformed)	Exponential	0.4	200
Non-marine sulphate	Exponential	90	180
Nitrate	Exponential	125	300
Ammonium	Exponential	180	220







AEA group  
329 Harwell  
Didcot  
Oxfordshire  
OX11 0QJ

Tel: 0870 190 1900  
Fax: 0870 190 6318