

# Annexes

<b>ANNEX 1:</b>	<b>Key Categories</b>	<b>617</b>
A 1.1	GENERAL APPROACH USED TO IDENTIFY KEY CATEGORIES	617
A 1.2	QUALITATIVE ANALYSIS USED TO IDENTIFY KEY CATEGORIES	618
A 1.3	QUANTITATIVE APPROACH 1 KCA FOLLOWING IPCC 2006 GUIDELINES	618
A 1.4	QUANTITATIVE APPROACH 2 KCA FOLLOWING IPCC 2006 GUIDELINES	664
A 1.5	KEY CATEGORY ANALYSIS (KCA) RANKING SYSTEM	694
A 1.6	USING THE UNCERTAINTY ANALYSIS TO PLAN IMPROVEMENTS IN THE PREPARATION OF THE INVENTORY	697
<b>ANNEX 2:</b>	<b>Assessment of Uncertainty</b>	<b>698</b>
A 2.1	ESTIMATION OF UNCERTAINTIES USING AN ERROR PROPAGATION APPROACH (APPROACH 1)	698
A 2.1.1	Key Categories	698
A 2.1.2	Tables of uncertainty estimates from the error propagation approach	700
A 2.2	ESTIMATION OF UNCERTAINTY BY SIMULATION (APPROACH 2)	710
A 2.2.1	Overview of the Method	710
A 2.2.2	Methodological details of the Monte Carlo model	710
A 2.2.3	Quality Control Checks on the Monte Carlo Model Output	711
A 2.3	UNCERTAINTY PARAMETERS	712
A 2.3.1	Uncertainty Parameters used	712
A 2.3.2	General Considerations	738
A 2.3.3	Uncertainty in the Trend	738
A 2.4	UNCERTAINTIES IN GWP WEIGHTED EMISSIONS	739
A 2.4.1	Uncertainty in the emissions	739
A 2.4.2	Uncertainty in the Trend	739
A 2.5	SECTORAL UNCERTAINTIES	742
A 2.5.1	Overview of the Method	742
A 2.6	COMPARISON OF UNCERTAINTIES FROM THE ERROR PROPAGATION AND MONTE CARLO ANALYSES	748

<b>ANNEX 3:</b>	<b>Other Detailed Methodological Descriptions for Individual Source or Sink Categories</b>	<b>750</b>
A 3.1	ENERGY 750	
A 3.1.1	Emission factors	750
A 3.1.2	Commonly used references	750
A 3.1.3	Feedstocks and Non-Energy Use (NEU) of fuels	753
A 3.1.4	Aviation (MS 7)	762
A 3.1.5	Gas leakage	765
A 3.1.6	Upstream oil and gas production (1A1cii, 1B2)	767
A 3.2	INDUSTRIAL PROCESSES (CRF SECTOR 2)	807
A 3.3	AGRICULTURE (CRF SECTOR 3)	807
A 3.3.1	Enteric Fermentation (3A)	809
A 3.3.2	Manure Management (3B)	810
A 3.3.3	Agricultural Soils (3D)	816
A 3.3.4	Liming	828
A 3.3.5	Urea application	829
A 3.3.6	Distribution of manure in different management systems	830
A 3.3.7	Description of the UK Agriculture Inventory Model	831
A 3.4	LAND USE, LAND USE CHANGE AND FORESTRY (CRF SECTOR 4)	865
A 3.4.1	Carbon stock changes due to afforestation and forest management (4A)	869
A 3.4.2	Alignment of CARBINE to the IPCC suggestions for “Use of Models in Good Practice National Greenhouse Gas Inventories”	875
A 3.4.3	Land Use Change and Soils (4B, 4C, 4E)	887
A 3.4.4	Changes in stocks of carbon in non-forest biomass due to management and land use change (4B2, 4C2, 4E2)	902
A 3.4.5	Carbon stock changes and biomass burning emissions due to Deforestation (4B, 4C, 4E, 4G)	907
A 3.4.6	Biomass Burning – Forest and Non-Forest Wildfires (4A, 4B, 4C)	911
A 3.4.7	Emissions from organic soils (4A, 4B, 4C, 4D, 4E, 4(II))	917
A 3.4.8	On-site and off-site emissions from peat extraction (4D)	926
A 3.4.9	Flooded Lands (4D)	930

A 3.4.10	Harvested Wood Products (4G)	931
A 3.4.11	Methods for the Overseas Territories (OTs) and Crown Dependencies (CDs)	932
A 3.4.12	Uncertainty analysis of the LULUCF sector	946
A 3.5	WASTE (CRF SECTOR 5)	949
A 3.5.1	Solid Waste Disposal on Land (5A)	949
A 3.5.2	Biological Treatment of Solid Waste (5B)	959
A 3.5.3	Waste Incineration (5C)	961
A 3.5.4	Wastewater Handling (5D)	965
A 3.6	UK CROWN DEPENDENCIES AND OVERSEAS TERRITORIES	968
A 3.6.1	Overview of Data Sources	968
A 3.6.2	Activity and Emissions Data	969
<b>ANNEX 4: National Energy Balance</b>		<b>976</b>
A 4.1	UK ENERGY BALANCE	976
A 4.2	FUELS DATA	980
A 4.2.1	Reallocations of energy data and differences from UK energy statistics	981
A 4.3	REPORTING ON CONSISTENCY WITH ENERGY DATA	998
<b>ANNEX 5: Additional Information to be Considered as Part of the Annual Inventory Submission</b>		<b>1002</b>
A 5.1	ANNUAL INVENTORY SUBMISSION	1002
<b>ANNEX 6: Comparison of Inventory and Emissions Estimated using Atmospheric Observations</b>		<b>1003</b>
A 6.1	MODELLING APPROACH USED FOR COMPARISON WITH THE UK GHGI	1003
A 6.2	METHANE	1005
A 6.3	NITROUS OXIDE	1008
A 6.4	HYDROFLUOROCARBONS	1011
A 6.4.1	HFC-134a	1017
A 6.4.2	HFC-143a	1018
A 6.4.3	HFC-125	1018
A 6.4.4	HFC-32	1019

A 6.4.5	HFC-227ea	1019
A 6.4.6	HFC-245fa	1019
A 6.4.7	HFC-23	1020
A 6.4.8	HFC-365mfc	1020
A 6.4.9	HFC-152a	1020
A 6.4.10	HFC-43-10mee	1021
A 6.5	PERFLUOROCARBONS	1021
A 6.5.1	PFC-14	1025
A 6.5.2	PFC-116	1026
A 6.5.3	PFC-218	1026
A 6.5.4	PFC-318	1026
A 6.6	SULPHUR HEXAFLUORIDE	1027
A 6.7	NITROGEN TRIFLUORIDE	1029
A 6.8	CARBON DIOXIDE	1031
<b>ANNEX 7: Analysis of EU/UK ETS Data</b>		<b>1033</b>
A 7.1	INTRODUCTION	1033
A 7.2	BACKGROUND	1036
A 7.2.1	EU/UK ETS Data and GHG Inventories	1036
A 7.2.2	Scope of the EU/UK ETS and Implications for the GHG Inventory	1037
A 7.2.3	Limitations of EU/UK ETS Data Integration with GHG Inventory: Autogeneration	1039
A 7.2.4	Data Processing	1040
A 7.3	EU/UK ETS DATA COVERAGE	1042
A 7.3.1	EU/UK ETS Data Use in the UK GHGI	1044
A 7.3.2	Activity and Emissions Data	1044
A 7.3.3	Implied Emission Factors	1048
A 7.4	CONSISTENCY OF REPORTED EMISSIONS WITH DATA FROM EMISSIONS TRADING SYSTEM	1063
<b>ANNEX 8: UK Domestic Emissions Reporting Requirements</b>		<b>1065</b>
A 8.1	NATIONAL STATISTICS	1066

**ANNEX 9: End User Emissions 1067**

A 9.1	INTRODUCTION	1067
A 9.2	DEFINITION OF END USERS	1067
A 9.3	OVERVIEW OF THE END USER CALCULATIONS	1068
A 9.4	EXAMPLE END USER CALCULATION	1069
A 9.5	END USER CALCULATION METHODOLOGY FOR THE UK GREENHOUSE GAS INVENTORY	1072
A 9.6	DETAILED EMISSIONS ACCORDING TO END USER CATEGORIES	1149

**ANNEX 10: Reporting on consistency of the reported data on air pollutants 1153**

A 10.1	NECR AND CLRTAP SUBMISSIONS	1153
--------	-----------------------------	------

**Table of Tables:**

Table A 1.3.1	Approach 1 Key Category Analysis for the base year based on level of emissions (including LULUCF) – UNFCCC scope .....	620
Table A 1.3.2	Approach 1 Key Category Analysis for the base year based on level of emissions (excluding LULUCF) – UNFCCC scope .....	628
Table A 1.3.3	Approach 1 Key Category Analysis for the latest reported year based on level of emissions (including LULUCF) – UNFCCC scope .....	634
Table A 1.3.4	Approach 1 Key Category Analysis for the latest reported year based on level of emissions (excluding LULUCF) – UNFCCC scope .....	642
Table A 1.3.5	Approach 1 Key Category Analysis based on trend in emissions (from base year to latest reported year, including LULUCF) – UNFCCC scope .....	649
Table A 1.3.6	Approach 1 Key Category Analysis based on trend in emissions (from base year to latest reported year, excluding LULUCF) – UNFCCC scope .....	657
Table A 1.4.1	Approach 2 Level Assessment for Base year (including LULUCF) with Key Categories Shaded in Grey – UNFCCC scope .....	665
Table A 1.4.2	Approach 2 Level Assessment for the latest reported year (including LULUCF) with Key Categories Shaded in Grey – UNFCCC scope .....	671
Table A 1.4.3	Approach 2 Level Assessment for Base year (not including LULUCF) with Key Categories Shaded in Grey – UNFCCC scope .....	676
Table A 1.4.4	Approach 2 Level Assessment for the latest reported year (not including LULUCF) with Key Categories Shaded in Grey – UNFCCC scope .....	680
Table A 1.4.5	Approach 2 Assessment for Trend (including LULUCF) with Key Categories Shaded in Grey – UNFCCC scope .....	685

## Contents of Annexes

---

Table A 1.4.6	Approach 2 Assessment for Trend (not including LULUCF) with Key Categories Shaded in Grey – UNFCCC scope .....	690
Table A 1.5.1	KCA Ranking.....	695
Table A 2.1.1	Summary of error propagation uncertainty estimates including LULUCF, base year to the latest reported year .....	700
Table A 2.3.1	Uncertainties in the activity data and emission factors for fuels used in the carbon dioxide (CO <sub>2</sub> ) inventory .....	713
Table A 2.3.2	Estimated uncertainties in the activity data and emission factors used in the methane (CH <sub>4</sub> ) inventory .....	727
Table A 2.3.3	Estimated uncertainties in the activity data and emission factors used in the nitrous oxide (N <sub>2</sub> O) inventory .....	732
Table A 2.3.4	Estimated uncertainties in the activity data and emission factors used in the F-gas inventory.....	736
Table A 2.4.1	Summary of Monte Carlo Uncertainty Estimates .....	740
Table A 2.5.1	Sectoral Uncertainty Estimates.....	743
Table A 2.6.1	Comparison of the error propagation (Approach 1) and Monte Carlo (Approach 2) uncertainty analyses .....	749
Table A 3.1.1	Summary of Emission Sources for UK Fuels Allocated as Non Energy Use in UK Energy Statistics.....	755
Table A 3.1.2	CAA aircraft types assigned to EMEP-EEA Emissions Inventory Guidebook aircraft types.....	762
Table A 3.1.3	Activity data and methane leakage estimates for Gas leakage at Point of Use, including cooking appliances, gas fires and boilers .....	766
Table A 3.1.4	UK Upstream Fuel Gas Carbon Dioxide EF per Source, 1990-2021.....	777
Table A 3.1.5	UK Upstream Fuel Gas Net Calorific Value per Source, 1990-2021 .....	778
Table A 3.1.6	UK Upstream Fuel Gas Density per Source, 1990-2021 .....	779
Table A 3.3.1	Livestock Population Data by Animal Type ('000 animal places) .....	808
Table A 3.3.2	Methane Emission Factors for Livestock Emissions for 2021 .....	809
Table A 3.3.3	Methane conversion factors for Manure Management Systems in the UK .	810
Table A 3.3.4	Nitrogen Excretion Factors, kg N animal place <sup>-1</sup> year <sup>-1</sup> for livestock in the UK (1990-2021).....	811
Table A 3.3.5	Distribution of Animal Waste Management Systems (%) used for Different Animal types, 2021 .....	813
Table A 3.3.6	Other agricultural waste management data and parameters.....	814
Table A 3.3.7	Percentage of layer manure and all other poultry manure applied to cropland .....	816

## Contents of Annexes

---

Table A 3.3.8	Other Organic N Fertilisers applied to soils – manure and non-manure based digestates.....	816
Table A 3.3.9	EF for direct N <sub>2</sub> O emissions from managed soils in the UK inventory .....	818
Table A 3.3.10	Areas of UK Crops and quantities of fertiliser applied for 2021 .....	818
Table A 3.3.11	Trends in area grown ('000 ha) and N fertiliser applied (kg/ha) for the major UK crops, 1990-2021.....	820
Table A 3.3.12	Parameter values for crop residue management .....	822
Table A 3.3.13	N concentrations in above and below ground biomass .....	824
Table A 3.3.14	Mineralised N from soils .....	826
Table A 3.3.15	N <sub>2</sub> O emissions from drained organic soils .....	827
Table A 3.3.16	Amount of N that is volatilized from agricultural inputs and associated N <sub>2</sub> O emissions .....	828
Table A 3.3.17	Amount of N fertilizers and other agricultural inputs that is lost through leaching and run-off and associated N <sub>2</sub> O emissions.....	828
Table A 3.3.18	Amount of limestone and dolomite applied to soils and associated CO <sub>2</sub> emissions .....	828
Table A 3.3.19	Amount of urea applied to soils and associated CO <sub>2</sub> emissions.....	829
Table A 3.3.20	Agriculture Inventory Annual Compilation Time-table .....	840
Table A 3.3.21	Agriculture Inventory: Main Annual Data Inputs per Data Provider .....	846
Table A 3.3.22	Mitigation Measures reflected within Inventory Source Methods.....	848
Table A 3.4.1	Main parameters for forest carbon flow model used to estimate carbon uptake by planting of forests of Sitka spruce ( <i>P. Sitchensis</i> ), yield class 12. ....	871
Table A 3.4.2	Compliance of the CARBINE model with the IPCC criteria on the use of models.....	875
Table A 3.4.3	Afforestation rate (kha p.a.) of conifers and broadleaves in the United Kingdom since 1500 based on estimates of woodland area by age from the NFI and administrative records.....	884
Table A 3.4.4	Mapping land-use data categories to LULUCF categories (GB: Great Britain, E: England, S: Scotland, W: Wales, NI: Northern Ireland, UK: United Kingdom of Great Britain and Northern Ireland).....	889
Table A 3.4.5	Weighted average change and range (±% from mean value) in equilibrium non-organic soil carbon density (t ha <sup>-1</sup> ) to 1 m deep for changes between different land types in England .....	897
Table A 3.4.6	Weighted average change and range (±% from mean value) in equilibrium non-organic soil carbon density (t ha <sup>-1</sup> ) to 1 m deep for changes between different land types in Scotland.....	898

## Contents of Annexes

---

Table A 3.4.7	Weighted average change and range ( $\pm\%$ from mean value) in equilibrium non-organic soil carbon density ( $\text{t ha}^{-1}$ ) to 1 m deep for changes between different land types in Wales.....	898
Table A 3.4.8	Weighted average change and range ( $\pm\%$ from mean value) in equilibrium non-organic soil carbon density ( $\text{t ha}^{-1}$ ) to 1 m deep for changes between different land types in Northern Ireland.....	898
Table A 3.4.9	Rates of change of soil carbon for land use change transitions .....	899
Table A 3.4.10	Range of times for soil carbon to reach 99% of a new value after a change in land use in England (E), Scotland (S), Wales (W) and Northern Ireland (NI) .....	899
Table A 3.4.11	Aggregation of Agricultural Census crop types for estimating biomass carbon stock changes from Cropland Management .....	903
Table A 3.4.12	Biomass stock factors for UK Cropland types .....	904
Table A 3.4.13	Aggregation of Countryside Survey Broad Habitats for estimating biomass carbon stock changes from Grassland Management.....	904
Table A 3.4.14	Biomass stock factors for UK Grassland types .....	905
Table A 3.4.15	Mean biomass carbon stock densities, $\text{tC/ha}$ .....	906
Table A 3.4.16	Weighted average change in equilibrium biomass carbon density ( $\text{tC/ha}$ ) for changes between different land types in England.....	906
Table A 3.4.17	Weighted average change in equilibrium biomass carbon density ( $\text{tC/ha}$ ) for changes between different land types in Scotland.....	906
Table A 3.4.18	Weighted average change in equilibrium biomass carbon density( $\text{tC/ha}$ ) for changes between different land types in Wales.....	907
Table A 3.4.19	Weighted average change in equilibrium biomass carbon density ( $\text{tC/ha}$ ) for changes between different land types in Northern Ireland.....	907
Table A 3.4.20	Countryside Survey data for Forest conversion .....	909
Table A 3.4.21	Corrected Forest conversion rates.....	910
Table A 3.4.22	IRS database property type descriptions by LULUCF sub-category .....	913
Table A 3.4.23	Estimated GHG emissions from controlled burning on Grassland, Gg.....	916
Table A 3.4.24	Assignment of peat areas (kha) to condition categories for each UK administration in 1990 and 2021.....	919
Table A 3.4.25	Estimated changes in area (kha) of each peat condition category due to land-use change, drainage and rewetting between 1990 and 2021 .....	919
Table A 3.4.26	Emission factors, $\text{CO}_2$ , $\text{CH}_4$ , $\text{N}_2\text{O}$ , for peat condition types, given in $\text{t CO}_2\text{-C ha}^{-1} \text{ yr}^{-1}$ , $\text{kg CH}_4 \text{ ha}^{-1} \text{ yr}^{-1}$ , and $\text{kg N}_2\text{O-N ha}^{-1} \text{ yr}^{-1}$ , respectively (updated from Evans et al (2017) and Brown et. al. 2020, 2021). Total fluxes are shown in $\text{tCO}_2\text{e ha}^{-1} \text{ yr}^{-1}$ using AR5 GWP with no feedbacks ( $\text{CH}_4= 28$ , $\text{N}_2\text{O} = 265$ ).A	



	positive EF indicates net GHG emission, and a negative EF indicates net GHG removal. Note that the EFs for Direct CH <sub>4</sub> include a correction for CH <sub>4</sub> lost in ditches (1-fraction of ditches in the landscape) as per Equation 2.6 and Table 2.4 in IPCC (2014), where applicable (i.e. drained status). Combined standard errors are shown for the Total EFs in brackets.....	922
Table A 3.4.27	Activity data for peat extraction sites in Northern Ireland .....	927
Table A 3.4.28	Annual peat production, m <sup>3</sup> for England and Scotland (from Annual Minerals Raised Inquiry/Mineral Extraction in Great Britain reports, and GMA, 2021) .....	928
Table A 3.4.29	Assignment of peat areas (kha) to condition categories for the Isle of Man in 1990 and 2021. ....	932
Table A 3.4.30	Information sources for estimating LULUCF emissions from the Overseas Territories and Crown Dependencies .....	935
Table A 3.4.31	Assumptions and EFs used in applying the Tier 1 methodology to the Overseas Territories and Crown Dependencies .....	936
Table A 3.4.32	Summary uncertainties for LULUCF sector activities .....	947
Table A 3.5.1	Composition of waste sorting residues and mixed municipal waste .....	950
Table A 3.5.2	DOC, DOCf and composition of waste materials .....	951
Table A 3.5.3	Amount of waste landfilled (Mt) (1945 to 2021).....	952
Table A 3.5.4	Amount of waste landfilled and methane generated, captured, utilised, flared, oxidised and emitted.....	955
Table A 3.5.5	Parameters used in landfill emission estimates for overseas territories and crown dependencies.....	957
Table A 3.5.6	Activity Data: Inputs in the composting process.....	959
Table A 3.5.7	Activity Data: Inputs in the anaerobic digestion process .....	960
Table A 3.5.8	Activity Data: UK Waste Incineration .....	961
Table A 3.5.9	Emissions Data: UK Waste Incineration (kt) .....	963
Table A 3.5.10	UK Domestic and Commercial Wastewater Treatment (5D1) Activity Data	965
Table A 3.5.11	UK Domestic and Commercial Waste Water Treatment (5D1) Implied Emission Factors.....	965
Table A 3.5.12	UK Domestic and Commercial Waste Water Treatment (5D1) Emission Estimates (kt CH <sub>4</sub> ) .....	966
Table A 3.5.13	UK Private Waste Water Management System Emission Estimates Parameters (5D1).....	967
Table A 3.5.14	UK Industrial Wastewater Treatment Activity Data, total industrial product per sector (5D2).....	967

## Contents of Annexes

---

Table A 3.6.1	Isle of Man, Guernsey and Jersey – Emissions of Direct GHGs (Mt CO <sub>2</sub> equivalent).....	969
Table A 3.6.2	Isle of Man, Guernsey and Jersey – Combustion activity data.....	969
Table A 3.6.3	Isle of Man, Guernsey and Jersey – Animal numbers.....	970
Table A 3.6.4	Isle of Man, Guernsey and Jersey – Total emissions from Agricultural Soils (Mt CO <sub>2</sub> equivalent) .....	971
Table A 3.6.5	Cayman Islands, Falklands Islands, and Bermuda - Emissions of Direct GHGs (Mt CO <sub>2</sub> equivalent) .....	971
Table A 3.6.6	Cayman Islands, Falklands Islands, and Bermuda – Combustion activity data .....	971
Table A 3.6.7	Cayman Islands, Falklands Islands, and Bermuda – Animal numbers.....	972
Table A 3.6.8	Cayman Islands, Falklands Islands, and Bermuda – Total emissions from Agricultural Soils (Mt CO <sub>2</sub> equivalent).....	973
Table A 3.6.9	Cayman Islands, Falklands Islands, and Bermuda - Amount of synthetic fertilizer applied .....	973
Table A 3.6.10	Gibraltar – Emissions of Direct GHGs (Mt CO <sub>2</sub> equivalent).....	973
Table A 3.6.11	Gibraltar – Combustion activity data .....	974
Table A 3.6.12	Isle of Man, Guernsey and Jersey – Total Municipal Solid Waste activity data (Gg).....	975
Table A 3.6.13	Cayman Islands, Falklands Islands, and Bermuda – Total Municipal Solid Waste activity data (Gg) .....	975
Table A 4.1.1	UK Energy Balance for 2021 (thousand tonnes of oil equivalent, gross energy basis) .....	977
Table A 4.2.1	Mapping of fuels used in IPCC and the NAEI .....	980
Table A 4.2.2	Fuel reconciliation: Coal use in the latest year (Mtonnes).....	982
Table A 4.2.3	Fuel reconciliation: Natural gas and Colliery Methane use in the latest year (TJ net).....	984
Table A 4.2.4	Fuel reconciliation: Fuel oil use in latest year (Mtonnes).....	986
Table A 4.2.5	Mapping of machinery types to dominant sector using machinery .....	989
Table A 4.2.6	Fuel reconciliation: Gas oil use in latest year (Mtonnes) .....	994
Table A 4.2.7	Fuel reconciliation: Use of Petroleum Gases in the latest year (Mt) .....	996
Table A 4.3.1	Comparison of UK GHGI reference approach to IEA returns' apparent consumption (for 2021).....	998
Table A 7.1.1	Summary of the use of EU/UK ETS data in the UK inventory .....	1035
Table A 7.3.1	Numbers of installations included in the EU/UK ETS data .....	1042

## Contents of Annexes

---

Table A 7.3.2	Refinery Emissions Data Comparison and Revision to OPG Activity .....	1045
Table A 7.3.3	EU/UK ETS data for Fuels used at Power Stations and Autogenerators (Emission Factors in kt / Mt for Coal & Fuel Oil, kt / Mth for Gases).....	1048
Table A 7.3.4	Refinery EU/UK ETS Data for Fuel Oil, OPG and Natural Gas (Emission Factors in kt / Mt for Fuel Oil and kt / Mth for OPG and Natural Gas) .....	1051
Table A 7.3.5	EU/UK ETS data for fuels used at integrated steelworks & coke ovens (Emission Factors in kt/Mt for solid & liquid fuels, kt/Mth for gases) .....	1054
Table A 7.3.6	EU/UK ETS data for Fuels used at Cement Kilns (kt / Mt) .....	1056
Table A 7.3.7	Comparison of Cement Sector Carbon Dioxide Emissions* within the UK GHGI and the EU/UK ETS.....	1058
Table A 7.3.8	EU/UK ETS data for Fuels used at Lime Kilns (Emission Factors in kt / Mt for Solid Fuels and kt / Mth for Gases).....	1059
Table A 7.3.9	EU/UK ETS emission factor data for production of lime (kt / Mt lime produced) .....	1060
Table A 7.3.10	EU/UK ETS data for Coal, Fuel Oil and Natural Gas used by Industrial Combustion Plant (Emission Factors in kt / Mt for Coal & Fuel Oil, kt / Mth for Natural Gas).....	1061
Table A 8.1.1	Summary table of GHG emissions by NC Category, including net emissions/removals from LULUCF (Mt CO <sub>2</sub> eq) – National Statistics coverage (UK only) .....	1066
Table A 8.1.2	Summary table of GHG emissions by Gas, including net emissions/removals from LULUCF (Mt CO <sub>2</sub> eq) – National Statistics coverage (UK only) .....	1066
Table A 9.4.1	Example of the outputs during an end user calculation.....	1071
Table A 9.5.1	Sources reallocated to end users and the fuels used.....	1073
Table A 9.5.2	End user category, IPCC sectors, and NAEI source names and activity names used in the emission calculation.....	1076
Table A 9.6.1	End user emissions from all National Communication categories, MtCO <sub>2</sub> equivalent.....	1150
Table A 9.6.2	End user CO <sub>2</sub> emissions from all National Communication categories, MtCO <sub>2</sub> equivalent.....	1150
Table A 9.6.3	End user CH <sub>4</sub> emissions from all National Communication categories, MtCO <sub>2</sub> equivalent.....	1151
Table A 9.6.4	End user N <sub>2</sub> O emissions from all National Communication categories, MtCO <sub>2</sub> equivalent.....	1152

### Table of Figures:

Figure A 3.1	UK Agriculture Inventory: Organisational Roles and Responsibilities.....	836
--------------	--	-----

Figure A 3.2	Inventory Model Data Flows: Overview of the Full Process .....	840
Figure A 3.3	Inventory Model Data Flows: Pre-processing Steps.....	852
Figure A 3.4	Inventory Model Data Flows: Pre-processing of the JAS/C.....	854
Figure A 3.5	Inventory Model Data Flows: Pre-processing of the CTS.....	855
Figure A 3.6	Inventory Model Data Flows: Source AD to Sector Database .....	857
Figure A 3.7	Inventory Model Data Flows: SQL Run Database to Outputs .....	859
Figure A 3.8	Data flow diagrams for each land use sub-category, showing cross-linkages between sectors: (i) 4A and 4G, (ii) 4B, (iii) 4C, (iv) 4D, (v) 4E .....	865
Figure A 3.9	The CARBINE SCOTIA model .....	874
Figure A 3.10	Transition matrix for England, representing the gross area change between land uses 1951-2020, showing the observations and posterior distribution of estimates. The grey shaded band is the 2.5-97.5 percentiles of the posterior distribution, with the MAP the black line within this. (Levy <i>et al.</i> 2021). .....	892
Figure A 3.11	Time series of the net change in the area of each land use 1950-2020, showing the observations and posterior distribution of estimates. The grey shaded band is the 2.5-97.5 percentiles of the posterior distribution, with the MAP the black line within this. (Levy <i>et al.</i> 2021). The thin coloured lines are the corrected observations, after accounting for systematic uncertainty, and interpolating.....	893
Figure A 3.12	Time series for UK land-use transitions 1951-2020, showing the mean, 95% confidence limits and the 1990-2019 inventory LUC time series, based on Countryside Survey and historic datasets.....	895
Figure A 3.13	Decision tree for assessing the effects of cropland management activities on soil carbon stocks.....	901
Figure A 3.14	Crop type area in the UK 1990-2021 .....	902
Figure A 3.15	Annual area of FIRMS thermal anomalies for GB for 2001 to 2010 (thermal anomalies were filtered to exclude those recorded over urban/industrial areas).....	914
Figure A 3.16	Time series of wildfire burnt areas in the UK 1990 to the current inventory year .....	915
Figure A 3.17	Final land cover hierarchy used to derive a separate EFs for UK peatlands, amended from Evans <i>et al.</i> (2017).....	918
Figure A 3.18	Area of land-use sub-categories on organic soils in 2021 in the UK .....	921
Figure A 3.19	Direct CO <sub>2</sub> emission factors (Tier 1, 2, 3) for UK peat condition types updated from Evans <i>et al.</i> (2017) ± standard error. Note that an EF for Forest is not shown as the Tier 3 method employed results in a range of EFs for forests on organic soils, which is due to changes in the age of forests and differences in afforestation over time. (All fluxes are shown in tCO <sub>2</sub> -C ha <sup>-1</sup> yr <sup>-1</sup> . Note that a	

	positive EF indicates net GHG emission, and a negative EF indicates net GHG removal). .....	923
Figure A 3.20	Direct CH <sub>4</sub> emission factors (Tier 1 and 2) for UK peat condition types updated from Evans et al (2017) ± standard error. Note that the EFs for Direct CH <sub>4</sub> include a correction for CH <sub>4</sub> lost in ditches (1-fraction of ditches in the landscape) as per Equation 2.6 and Table 2.4 in IPCC (2014), where applicable (i.e. drained status). (All fluxes are shown in Kg CH <sub>4</sub> ha <sup>-1</sup> yr <sup>-1</sup> ). ..	924
Figure A 3.21	Direct N <sub>2</sub> O emission factors (Tier 1 and 2) for UK peat condition types updated from Evans et al (2017) ± standard error. (All fluxes are shown in Kg N <sub>2</sub> O-N ha <sup>-1</sup> yr <sup>-1</sup> ). .....	924
Figure A 4.1	Gas oil reconciliation visual representation: example where there is enough fuel to allocate to bottom-up NRMM estimates .....	992
Figure A 4.2	Gas oil reconciliation visual representation: example where there is not enough fuel to allocate to bottom-up NRMM estimates.....	993
Figure A 6.1	Background Northern Hemisphere monthly concentrations of (a) CH <sub>4</sub> , and (b) N <sub>2</sub> O, estimated from MHD, Ireland observations are shown in red, and background Southern Hemisphere monthly concentrations from CGO, Tasmania are shown in blue. Grey shading represents unratiified data. ...	1005
Figure A 6.2	Verification of the UK emission inventory estimates for CH <sub>4</sub> in Tg CO <sub>2</sub> -eq yr <sup>-1</sup> (a) from 1990 and (b) from 2006. GHGI estimates are shown in black. InTEM 2-site 2-year estimates are shown in green (±1σ). InTEM full network, 1-month annualised, estimates are shown in blue (±1σ). InTEM 7-site, 2-month annualised, estimates are shown in red (±1σ). .....	1006
Figure A 6.3	Verification of the UK emission inventory estimates for CH <sub>4</sub> in Tg CO <sub>2</sub> -eq month <sup>-1</sup> from 2006. GHGI estimates are shown in black. InTEM 2-month estimates are shown in red (±1σ). InTEM 1-month estimates are shown in blue (±1σ). .....	1007
Figure A 6.4	Four-year average CH <sub>4</sub> InTEM emission estimates (kg km <sup>-2</sup> yr <sup>-1</sup> of gas) 2019-2022 by season: (a) Spring (b) Summer (c) Autumn and (d) Winter. The observation stations are shown as blue triangles. Major cities are shown as red circles. ....	1008
Figure A 6.5	Verification of the UK emission inventory estimates for N <sub>2</sub> O in Tg CO <sub>2</sub> -eq yr <sup>-1</sup> (a) from 1990 and (b) from 2012. GHGI estimates are shown in black. InTEM 1-site, 3-year estimates are shown in green (±1σ), InTEM full network, 1-month, annualised, estimates are shown in blue (±1σ). .....	1009
Figure A 6.6	Verification of the UK emission inventory estimates for N <sub>2</sub> O in Tg CO <sub>2</sub> -eq month <sup>-1</sup> from 2012. GHGI estimates are shown in black. InTEM 1-month estimates are shown in blue (±1σ). .....	1010
Figure A 6.7	Four-year average N <sub>2</sub> O InTEM emission estimates (kg km <sup>-2</sup> yr <sup>-1</sup> of gas) 2019-2022 by season: (a) Spring (b) Summer (c) Autumn and (d) Winter. The observation stations are shown as blue triangles. Major cities are shown as red circles. ....	1010

Figure A 6.8	Sum of UK HFC emission estimates (HFC-125, HFC-134a, HFC-143a, HFC-152a, HFC-23, HFC-32, HFC-227ea, HFC-245fa, HFC-365mfc and HFC-43-10mee) in Tg CO <sub>2</sub> -eq yr <sup>-1</sup> from the GHGI (black) and InTEM, annualised 2-year inversion (blue) and 1-year inversion (orange). Note HFC-43-10mee (< 0.2 Tg CO <sub>2</sub> -eq yr <sup>-1</sup> ) is included from 2011 when the observations start. The uncertainty bars represent ±1σ. ....	1011
Figure A 6.9	Background Northern Hemisphere monthly concentrations of six HFCs estimated from MHD, Ireland observations are shown in red, and background Southern Hemisphere monthly concentrations from CGO, Tasmania are shown in blue. Grey shading represents unratified data. ....	1012
Figure A 6.10	Background Northern Hemisphere monthly concentrations of four HFCs estimated from MHD, Ireland observations are shown in red, and background Southern Hemisphere monthly concentrations from CGO, Tasmania are shown in blue. Grey shading represents unratified data. ....	1013
Figure A 6.11	Comparison of the UK emission inventory estimates for individual HFCs in Tg CO <sub>2</sub> -eq yr <sup>-1</sup> from 1990. GHGI estimates are shown in black. InTEM 2-year estimates are shown in blue (±1σ), InTEM 1-year estimates are shown in orange (±1σ).....	1014
Figure A 6.12	Verification of the UK emission inventory estimates for individual HFC's in Tg CO <sub>2</sub> -eq yr <sup>-1</sup> from 1990. GHGI estimates are shown in black. InTEM 2-year estimates are shown in blue (±1σ), InTEM 1-year estimates are shown in orange (±1σ).....	1015
Figure A 6.13	Four-year average HFC-134a InTEM emission estimates (kg km <sup>-2</sup> yr <sup>-1</sup> ) 2019-2022. The observation stations are shown as blue triangles. Major cities are shown as red circles. ....	1016
Figure A 6.14	Four-year average HFC InTEM emission estimates (kg km <sup>-2</sup> yr <sup>-1</sup> ) 2019-2022. The observation stations are shown as blue triangles. Major cities are shown as red circles. ....	1017
Figure A 6.15	Sum of UK PFC emission estimates (PFC-14, PFC-116, PFC-218, PFC-318) in Tg CO <sub>2</sub> -eq yr <sup>-1</sup> from the GHGI (black) and InTEM, annualised 2-year inversion (blue) and 1-year inversion (orange). The InTEM uncertainty bounds represent 1-σ. ....	1022
Figure A 6.16	Background Northern Hemisphere monthly concentrations of four PFCs estimated from MHD, Ireland observations are shown in red, and background Southern Hemisphere monthly concentrations from CGO, Tasmania are shown in blue. Grey shading represents unratified data. ....	1023
Figure A 6.17	Verification of the UK emission inventory estimates for PFCs in Tg CO <sub>2</sub> -eq yr <sup>-1</sup> from 1990. GHGI estimates are shown in black. InTEM 2-year estimates are shown in blue (±1σ), InTEM 1-year estimates are shown in orange (±1σ). ....	1024
Figure A 6.18	Four-year average PFC InTEM emission estimates (kg km <sup>-2</sup> yr <sup>-1</sup> ) 2019-2022. The observation stations are shown as blue triangles. Major cities are shown as red circles. ....	1025

Figure A 6.19	Background Northern Hemisphere monthly concentrations of (a) SF <sub>6</sub> and (b) NF <sub>3</sub> estimated from MHD, Ireland observations are shown in red, and background Southern Hemisphere monthly concentrations from CGO, Tasmania are shown in blue. Grey shading represents unratified data. ...	1027
Figure A 6.20	Verification of the UK emission inventory estimates for SF <sub>6</sub> in Tg CO <sub>2</sub> -eq yr <sup>-1</sup> from (a) 1990 and (b) 2012. GHGI estimates are shown in black. InTEM 2-year estimates are shown in green ( $\pm 1\sigma$ ), InTEM annualised 1-month estimates are shown in blue ( $\pm 1\sigma$ ). .....	1027
Figure A 6.21	Verification of the UK emission inventory estimates for SF <sub>6</sub> in Tg CO <sub>2</sub> -eq yr <sup>-1</sup> from 2012. GHGI estimates are shown in black. InTEM 1-month estimates are shown in blue ( $\pm 1\sigma$ ). .....	1028
Figure A 6.22	Four-year average SF <sub>6</sub> InTEM emission estimates (kg km <sup>-2</sup> yr <sup>-1</sup> of gas) 2019-2022. The observation stations are shown as blue triangles. Major cities are shown as red circles. ....	1029
Figure A 6.23	Verification of the UK emission inventory estimates for NF <sub>3</sub> in Tg CO <sub>2</sub> -eq yr <sup>-1</sup> from 2012. GHGI estimates are too small to see. InTEM 2-year estimates are shown in blue ( $\pm 1\sigma$ ), InTEM 1-year estimates are shown in orange ( $\pm 1\sigma$ ). .....	1030
Figure A 6.24	Four-year average NF <sub>3</sub> InTEM emission estimates (kg km <sup>-2</sup> yr <sup>-1</sup> of gas) 2019-2022. The observation stations are shown as blue triangles. Major cities are shown as red circles. ....	1030
Figure A 6.25	Background Northern Hemisphere monthly concentrations of CO <sub>2</sub> estimated from MHD, Ireland observations (data obtained from LSCE equipment through a data sharing agreement) are shown in red, and background Southern Hemisphere monthly concentrations from CGO, Tasmania are shown in blue. Grey shading represents unratified data. ....	1031
Figure A 9.1	Simplified fuel flows for an end user calculation.....	1068
Figure A 9.2	Fuel use in the example calculation.....	1070
Figure A 9.3	Comparison of 'direct' and end user emissions of carbon according the sectors considered in the end user example.....	1072

---

## ANNEX 1: Key Categories

This annex contains the key category analysis for the latest GHG inventory<sup>1</sup>. It contains:

- A description of the methodology used for identifying key categories
- Information on the level of disaggregation
- Information to fulfil the reporting requirements of Tables 4.2 and 4.3 of Volume 1 of the 2006 IPCC Guidelines, including and excluding land use, land-use change and forestry (LULUCF).

### A 1.1 GENERAL APPROACH USED TO IDENTIFY KEY CATEGORIES

In the UK inventory, certain source categories are particularly significant in terms of their contribution to the overall uncertainty of the inventory. These key source categories have been identified so that the resources available for inventory preparation may be prioritised, and the best possible estimates prepared for the most significant source categories.

The UK completes both quantitative and qualitative Key Category Analyses (KCAs).

The UK has used the method set out in Section 4.3.1 and Section 4.3.2 of the 2006 IPCC Guidelines Volume 1 General Guidance and Reporting (*Approach 1 to identify key categories*, and *Approach 2 to identify key categories* respectively) to quantitatively determine the key source categories.

---

<sup>1</sup> Following the requirements to report information about uncertainties as set out in FCCC/CP/2013/10/Add.3. Report of the Conference of the Parties on its nineteenth session, held in Warsaw from 11 to 23 November 2013. Addendum Part two: Action taken by the Conference of the Parties at its nineteenth session.



## A 1.2 QUALITATIVE ANALYSIS USED TO IDENTIFY KEY CATEGORIES

Following IPCC good practice, a qualitative analysis of the inventory has been made to identify any additional key source categories, which may not have been identified using the quantitative analysis. The approach set out in Section 4.3.3 of the IPCC 2006 Guidelines has been applied, using the four criteria set out in the guidance, to judge whether a category is a key category. The criteria are:

1. (Use of) mitigation techniques and technologies;
2. Emissions growth (increase or decrease);
3. No quantitative assessment of uncertainties performed;
4. Completeness (examine qualitatively potential key categories that are not yet estimated quantitatively by applying the qualitative considerations above).

In addition, additional criteria have also been taken in account

5. High uncertainty (links to point 3 above);
6. Unexpectedly low or high emissions;
7. External recommendation has also been used as an additional criterion to identify key categories.

The results of the qualitative analysis did not identify any categories that were not already identified by the quantitative key category analysis.

## A 1.3 QUANTITATIVE APPROACH 1 KCA FOLLOWING IPCC 2006 GUIDELINES

A key category analysis has been completed for both level and trend. This KCA has been created using the 2006 IPCC Guidelines Approach 1 methodology. The factors that make a source a key category are:

- A high contribution to the level of emissions; and
- A high contribution to the trend;

For example, transport fuel (1A3b) is a key category for carbon dioxide because it is a large source of emissions and nitric acid production (2B2) because it shows a significant trend.

The category groupings are largely aligned to those suggested in Tables 4.5 and 4.6 in Volume 1, Chapter 4 of the 2006 IPCC guidelines, although we deviate in a number of cases, in particular:

- **Agriculture and LULUCF.** In the 2006 guidelines a different nomenclature for categorising agriculture and LULUCF sources and sinks was used compared to the adopted nomenclature, which means that it would be challenging and confusing to retain this categorisation when sources are grouped differently in the adopted nomenclature. The UK Inventory Agency considers that the level of aggregation used in the UK method for the KCA is sufficiently detailed to target inventory improvements whilst not introducing unnecessary computational difficulties (e.g. use of “miscellaneous” categories to mop up the remainder within a sector). Further, the level of source/sink category aggregations in the KCA are aligned to how individual methods or models are used to derive the UK inventory estimates, and are therefore at an appropriate level of detail for the UK inventory
- **Fugitive Emissions.** The suggested categories are at a much more granular level (e.g. 1B2a<sub>ii</sub>) than other sectors. We considered that this would lead to an undue diminishing of these sectors, decreasing their likelihood of being considered key, so have adopted a level of aggregation more consistent with other sectors
- **Miscellaneous emissions.** The suggested approach was to group a large number of small sources into one category. We considered that this would lead to an undue increase in the significance of these sources, increasing their likelihood of being considered key, so have adopted a level of aggregation more consistent with other sectors

The results of the key category analysis with and without LULUCF, for the base year and the latest reported year and for both Approaches 1 and 2 KCA, are summarised by sector and gases in **Section 1.5.1**. The tables indicate whether a key category arises from the level (L1) assessment or the trend (T1) assessment.

The results of the **level assessment** (based on Approach 1) with and without LULUCF for the base year and the latest reported year are shown **Table A 1.3.1** to **Table A 1.3.4**. The key source categories are highlighted by the shaded cells in the table. The source categories (i.e. rows of the table) were sorted in descending order of magnitude based on the results of the “Level Parameter”, and then the cumulative total was included in the final column of the table. The key source categories are those whose contributions add up to 95% of the sum of the level parameters in the final column after this sorting process, which according to the 2006 IPCC guidelines, should account for 90% of the uncertainty in level.

The results of the **trend assessment** (based on Approach 1) with and without LULUCF for the base year to the latest reported year are shown in **Table A 1.3.5** and **Table A 1.3.6**. The key source categories are highlighted by the shaded cells in the table. The trend parameter was calculated using the absolute value of the result; an absolute function is used since Land Use, Land Use Change and Forestry contains negative sources (sinks) and the absolute function is necessary to produce positive uncertainty contributions for these sinks. The source categories (i.e. rows of the table) were sorted in descending order of the “Trend parameter”, and then the cumulative total was included in the final column of the table.

The key source categories are those whose contributions add up to 95% of the sum of the trend parameters in the final column after this sorting process, which according to the 2006 IPCC guidelines, should account for 90% of the uncertainty in trend.

Note that the tables in chapter 1 of the NIR summarise the key categories from both the approach 1 and approach 2 key categories analyses and the aggregations used are slightly different for the two approaches. For example, the category "3A" is therefore total emissions from category 3A, whilst categories 3A1 and 3A2 have also been identified as key categories in their own right.

**Table A 1.3.1 Approach 1 Key Category Analysis for the base year based on level of emissions (including LULUCF) – UNFCCC scope**

IPCC Code	IPCC Category	GHG	Base year emissions (Gg CO <sub>2</sub> e)	Absolute value of Base year emissions (Gg CO <sub>2</sub> e)	Level Assessment	Cumulative Total
1A1	Energy industries: solid fuels	CO <sub>2</sub>	185,488.39	185,488.39	0.2173	0.2173
1A3b	Road transportation: liquid fuels	CO <sub>2</sub>	109,173.97	109,173.97	0.1279	0.3453
1A4	Other sectors: gaseous fuels	CO <sub>2</sub>	70,371.86	70,371.86	0.0825	0.4277
5A	Solid waste disposal	CH <sub>4</sub>	67,633.35	67,633.35	0.0793	0.5070
1A1	Energy industries: liquid fuels	CO <sub>2</sub>	40,387.53	40,387.53	0.0473	0.5543
1A2	Manufacturing industries and construction: liquid fuels	CO <sub>2</sub>	27,665.96	27,665.96	0.0324	0.5867
1A2	Manufacturing industries and construction: gaseous fuels	CO <sub>2</sub>	27,291.18	27,291.18	0.0320	0.6187
1B1	Coal mining and handling	CH <sub>4</sub>	24,446.08	24,446.08	0.0286	0.6474
2C1	Iron and steel production	CO <sub>2</sub>	23,628.28	23,628.28	0.0277	0.6750
1A4	Other sectors: liquid fuels	CO <sub>2</sub>	21,465.76	21,465.76	0.0252	0.7002
3A1	Enteric fermentation from Cattle	CH <sub>4</sub>	21,166.02	21,166.02	0.0248	0.7250
1A2	Manufacturing industries and construction: solid fuels	CO <sub>2</sub>	20,209.42	20,209.42	0.0237	0.7487
1A4	Other sectors: solid fuels	CO <sub>2</sub>	19,824.90	19,824.90	0.0232	0.7719

IPCC Code	IPCC Category	GHG	Base year emissions (Gg CO <sub>2</sub> e)	Absolute value of Base year emissions (Gg CO <sub>2</sub> e)	Level Assessment	Cumulative Total
2B3	Adipic acid production	N <sub>2</sub> O	17,727.08	17,727.08	0.0208	0.7927
2B9	Fluorochemical production	HFCs, PFCs, SF <sub>6</sub> and NF <sub>3</sub>	14,911.66	14,911.66	0.0175	0.8101
4B	Cropland	CO <sub>2</sub>	14,230.88	14,230.88	0.0167	0.8268
4A	Forest land	CO <sub>2</sub>	-13,940.16	13,940.16	0.0163	0.8432
1B2	Oil and gas extraction	CH <sub>4</sub>	13,835.90	13,835.90	0.0162	0.8594
3D	Agricultural soils	N <sub>2</sub> O	13,428.41	13,428.41	0.0157	0.8751
1A1	Energy industries: gaseous fuels	CO <sub>2</sub>	11,939.20	11,939.20	0.0140	0.8891
1A3d	Domestic Navigation: liquid fuels	CO <sub>2</sub>	7,611.13	7,611.13	0.0089	0.8980
2A1	Cement production	CO <sub>2</sub>	7,295.26	7,295.26	0.0085	0.9066
3A2	Enteric fermentation from Sheep	CH <sub>4</sub>	5,858.92	5,858.92	0.0069	0.9134
4E	Settlements	CO <sub>2</sub>	5,426.53	5,426.53	0.0064	0.9198
1A5	Other: liquid fuels	CO <sub>2</sub>	5,293.44	5,293.44	0.0062	0.9260
1B2	Oil and gas extraction	CO <sub>2</sub>	5,088.53	5,088.53	0.0060	0.9320
2B8	Petrochemical and carbon black production	CO <sub>2</sub>	4,751.56	4,751.56	0.0056	0.9375
3B1	Manure management from Cattle	CH <sub>4</sub>	4,646.15	4,646.15	0.0054	0.9430
2B2	Nitric acid production	N <sub>2</sub> O	3,432.78	3,432.78	0.0040	0.9470
3B2	Manure management from Sheep	N <sub>2</sub> O	3,038.90	3,038.90	0.0036	0.9505
4C	Grassland	CH <sub>4</sub>	2,807.05	2,807.05	0.0033	0.9538
5D	Wastewater treatment and discharge	CH <sub>4</sub>	2,365.31	2,365.31	0.0028	0.9566

IPCC Code	IPCC Category	GHG	Base year emissions (Gg CO <sub>2</sub> e)	Absolute value of Base year emissions (Gg CO <sub>2</sub> e)	Level Assessment	Cumulative Total
4D	Wetlands	CH <sub>4</sub>	2,313.24	2,313.24	0.0027	0.9593
4G	Harvested wood products	CO <sub>2</sub>	-2,096.17	2,096.17	0.0025	0.9618
2B1	Ammonia production	CO <sub>2</sub>	1,895.00	1,895.00	0.0022	0.9640
1A3a	Domestic aviation: liquid fuels	CO <sub>2</sub>	1,869.71	1,869.71	0.0022	0.9662
1B1	Coal mining and handling	CO <sub>2</sub>	1,698.56	1,698.56	0.0020	0.9682
1A3c	Railways: liquid fuels	CO <sub>2</sub>	1,469.34	1,469.34	0.0017	0.9699
5C	Incineration and open burning of waste	CO <sub>2</sub>	1,445.17	1,445.17	0.0017	0.9716
1A4	Other sectors: solid fuels	CH <sub>4</sub>	1,440.83	1,440.83	0.0017	0.9733
1A3b	Road transportation: liquid fuels	CH <sub>4</sub>	1,408.61	1,408.61	0.0017	0.9749
2C6	Zinc production	CO <sub>2</sub>	1,350.65	1,350.65	0.0016	0.9765
2A2	Lime production	CO <sub>2</sub>	1,328.60	1,328.60	0.0016	0.9781
2A4	Other process uses of carbonates	CO <sub>2</sub>	1,198.69	1,198.69	0.0014	0.9795
1A3b	Road transportation: liquid fuels	N <sub>2</sub> O	1,176.81	1,176.81	0.0014	0.9809
3G	Liming	CO <sub>2</sub>	1,019.16	1,019.16	0.0012	0.9820
1A1	Energy industries: solid fuels	N <sub>2</sub> O	939.47	939.47	0.0011	0.9831
2G1	Electrical equipment	HFCs, PFCs, SF <sub>6</sub> and NF <sub>3</sub>	828.89	828.89	0.0010	0.9841
5D	Wastewater treatment and discharge	N <sub>2</sub> O	796.37	796.37	0.0009	0.9851
4D	Wetlands	CO <sub>2</sub>	668.77	668.77	0.0008	0.9858
4B	Cropland	N <sub>2</sub> O	653.25	653.25	0.0008	0.9866

IPCC Code	IPCC Category	GHG	Base year emissions (Gg CO <sub>2</sub> e)	Absolute value of Base year emissions (Gg CO <sub>2</sub> e)	Level Assessment	Cumulative Total
4C	Grassland	CO <sub>2</sub>	-618.75	618.75	0.0007	0.9873
2D	Non-energy products from fuels and solvent use	CO <sub>2</sub>	552.81	552.81	0.0006	0.9880
2G3	N <sub>2</sub> O from product uses	N <sub>2</sub> O	493.41	493.41	0.0006	0.9886
1A4	Other sectors: peat	CO <sub>2</sub>	453.50	453.50	0.0005	0.9891
2C3	Aluminium production	CO <sub>2</sub>	450.32	450.32	0.0005	0.9896
4A	Forest land	N <sub>2</sub> O	438.95	438.95	0.0005	0.9901
2A3	Glass production	CO <sub>2</sub>	412.37	412.37	0.0005	0.9906
2F4	Aerosols	HFCs, PFCs, SF <sub>6</sub> and NF <sub>3</sub>	407.71	407.71	0.0005	0.9911
2C4	Magnesium production	HFCs, PFCs, SF <sub>6</sub> and NF <sub>3</sub>	399.06	399.06	0.0005	0.9916
4E	Settlements	N <sub>2</sub> O	392.31	392.31	0.0005	0.9920
3A4	Enteric fermentation from Other livestock	CH <sub>4</sub>	338.26	338.26	0.0004	0.9924
4B	Cropland	CH <sub>4</sub>	332.36	332.36	0.0004	0.9928
3A3	Enteric fermentation from Swine	CH <sub>4</sub>	317.02	317.02	0.0004	0.9932
3J	Agriculture activities in OTs and CDs	CH <sub>4</sub>	306.10	306.10	0.0004	0.9935
2C3	Aluminium production	HFCs, PFCs, SF <sub>6</sub> and NF <sub>3</sub>	299.84	299.84	0.0004	0.9939
3H	Urea application to land	CO <sub>2</sub>	293.75	293.75	0.0003	0.9942
4	Indirect N <sub>2</sub> O emissions from LULUCF	N <sub>2</sub> O	271.94	271.94	0.0003	0.9945
1A1	Energy industries: other fuels	CO <sub>2</sub>	244.37	244.37	0.0003	0.9948

IPCC Code	IPCC Category	GHG	Base year emissions (Gg CO <sub>2</sub> e)	Absolute value of Base year emissions (Gg CO <sub>2</sub> e)	Level Assessment	Cumulative Total
1A1	Energy industries: gaseous fuels	N <sub>2</sub> O	232.10	232.10	0.0003	0.9951
2B7	Soda ash production	CO <sub>2</sub>	224.40	224.40	0.0003	0.9954
1A4	Other sectors: solid fuels	N <sub>2</sub> O	218.14	218.14	0.0003	0.9956
2B10	Other Chemical Industry	CH <sub>4</sub>	214.15	214.15	0.0003	0.9959
5C	Incineration and open burning of waste	CH <sub>4</sub>	213.78	213.78	0.0003	0.9961
3F	Field burning of agricultural residues	CH <sub>4</sub>	209.47	209.47	0.0002	0.9964
2F1	Refrigeration and air conditioning	HFCs, PFCs, SF <sub>6</sub> and NF <sub>3</sub>	201.39	201.39	0.0002	0.9966
2G2	SF <sub>6</sub> and PFCs from other product use	HFCs, PFCs, SF <sub>6</sub> and NF <sub>3</sub>	191.54	191.54	0.0002	0.9968
1A4	Other sectors: gaseous fuels	CH <sub>4</sub>	176.56	176.56	0.0002	0.9970
2F2	Foam blowing agents	HFCs, PFCs, SF <sub>6</sub> and NF <sub>3</sub>	167.80	167.80	0.0002	0.9972
3J	Agriculture activities in OTs and CDs	N <sub>2</sub> O	155.42	155.42	0.0002	0.9974
1A1	Energy industries: gaseous fuels	CH <sub>4</sub>	144.26	144.26	0.0002	0.9976
4C	Grassland	N <sub>2</sub> O	134.86	134.86	0.0002	0.9977
1A2	Manufacturing industries and construction: solid fuels	N <sub>2</sub> O	125.66	125.66	0.0001	0.9979
2B6	Titanium dioxide production	CO <sub>2</sub>	104.63	104.63	0.0001	0.9980
1A2	Manufacturing industries and construction: liquid fuels	N <sub>2</sub> O	102.15	102.15	0.0001	0.9981
1A4	Other sectors: biomass	CH <sub>4</sub>	100.88	100.88	0.0001	0.9982
1A1	Energy industries: liquid fuels	N <sub>2</sub> O	99.98	99.98	0.0001	0.9984

IPCC Code	IPCC Category	GHG	Base year emissions (Gg CO <sub>2</sub> e)	Absolute value of Base year emissions (Gg CO <sub>2</sub> e)	Level Assessment	Cumulative Total
4A	Forest land	CH <sub>4</sub>	99.49	99.49	0.0001	0.9985
1A3e	Other transportation: liquid fuels	CO <sub>2</sub>	98.14	98.14	0.0001	0.9986
1A3d	Domestic Navigation: liquid fuels	N <sub>2</sub> O	93.38	93.38	0.0001	0.9987
1A4	Other sectors: liquid fuels	N <sub>2</sub> O	83.51	83.51	0.0001	0.9988
1A4	Other sectors: liquid fuels	CH <sub>4</sub>	73.07	73.07	0.0001	0.9989
1A2	Manufacturing industries and construction: other fuels	CO <sub>2</sub>	70.61	70.61	0.0001	0.9990
5C	Incineration and open burning of waste	N <sub>2</sub> O	61.44	61.44	0.0001	0.9990
1A1	Energy industries: solid fuels	CH <sub>4</sub>	56.99	56.99	0.0001	0.9991
3F	Field burning of agricultural residues	N <sub>2</sub> O	51.40	51.40	0.0001	0.9992
1A2	Manufacturing industries and construction: solid fuels	CH <sub>4</sub>	50.06	50.06	0.0001	0.9992
1A5	Other: liquid fuels	N <sub>2</sub> O	49.91	49.91	0.0001	0.9993
2C1	Iron and steel production	CH <sub>4</sub>	43.92	43.92	0.0001	0.9993
2G4	Other product manufacture and use	N <sub>2</sub> O	40.20	40.20	0.0000	0.9994
1B2	Oil and gas extraction	N <sub>2</sub> O	39.74	39.74	0.0000	0.9994
1A1	Energy industries: liquid fuels	CH <sub>4</sub>	38.63	38.63	0.0000	0.9995
1A4	Other sectors: peat	CH <sub>4</sub>	35.94	35.94	0.0000	0.9995
1A2	Manufacturing industries and construction: liquid fuels	CH <sub>4</sub>	35.43	35.43	0.0000	0.9996
2A4	Other process uses of carbonates	CH <sub>4</sub>	34.84	34.84	0.0000	0.9996
2B8	Petrochemical and carbon black production	CH <sub>4</sub>	33.79	33.79	0.0000	0.9996
1A4	Other sectors: gaseous fuels	N <sub>2</sub> O	33.42	33.42	0.0000	0.9997



IPCC Code	IPCC Category	GHG	Base year emissions (Gg CO <sub>2</sub> e)	Absolute value of Base year emissions (Gg CO <sub>2</sub> e)	Level Assessment	Cumulative Total
2F6	Other product uses as substitutes for ODS	HFCs, PFCs, SF <sub>6</sub> and NF <sub>3</sub>	23.59	23.59	0.0000	0.9997
5B	Biological treatment of solid waste	CH <sub>4</sub>	21.89	21.89	0.0000	0.9997
1A1	Energy industries: other fuels	CH <sub>4</sub>	20.77	20.77	0.0000	0.9998
1A2	Manufacturing industries and construction: biomass	N <sub>2</sub> O	19.38	19.38	0.0000	0.9998
4E	Settlements	CH <sub>4</sub>	19.03	19.03	0.0000	0.9998
4D	Wetlands	N <sub>2</sub> O	18.90	18.90	0.0000	0.9998
2C1	Iron and steel production	N <sub>2</sub> O	18.43	18.43	0.0000	0.9998
1A3a	Domestic aviation: liquid fuels	N <sub>2</sub> O	15.74	15.74	0.0000	0.9999
1A2	Manufacturing industries and construction: biomass	CH <sub>4</sub>	15.36	15.36	0.0000	0.9999
1A2	Manufacturing industries and construction: gaseous fuels	CH <sub>4</sub>	13.69	13.69	0.0000	0.9999
1A2	Manufacturing industries and construction: gaseous fuels	N <sub>2</sub> O	12.95	12.95	0.0000	0.9999
5B	Biological treatment of solid waste	N <sub>2</sub> O	12.36	12.36	0.0000	0.9999
1A4	Other sectors: biomass	N <sub>2</sub> O	12.04	12.04	0.0000	0.9999
2E1	Integrated circuit or semiconductor	HFCs, PFCs, SF <sub>6</sub> and NF <sub>3</sub>	11.10	11.10	0.0000	1.0000
1A3a	Domestic aviation: liquid fuels	CH <sub>4</sub>	7.69	7.69	0.0000	1.0000
1A1	Energy industries: other fuels	N <sub>2</sub> O	5.96	5.96	0.0000	1.0000
1A3d	Domestic Navigation: liquid fuels	CH <sub>4</sub>	4.10	4.10	0.0000	1.0000
1A5	Other: liquid fuels	CH <sub>4</sub>	3.98	3.98	0.0000	1.0000
1A3c	Railways: liquid fuels	N <sub>2</sub> O	2.93	2.93	0.0000	1.0000

IPCC Code	IPCC Category	GHG	Base year emissions (Gg CO <sub>2</sub> e)	Absolute value of Base year emissions (Gg CO <sub>2</sub> e)	Level Assessment	Cumulative Total
1A3c	Railways: liquid fuels	CH <sub>4</sub>	2.75	2.75	0.0000	1.0000
2B8	Petrochemical and carbon black production	N <sub>2</sub> O	1.96	1.96	0.0000	1.0000
1A4	Other sectors: peat	N <sub>2</sub> O	1.59	1.59	0.0000	1.0000
2F3	Fire protection	HFCs, PFCs, SF <sub>6</sub> and NF <sub>3</sub>	1.47	1.47	0.0000	1.0000
1A3e	Other transportation: liquid fuels	N <sub>2</sub> O	1.05	1.05	0.0000	1.0000
1A1	Energy industries: biomass	CH <sub>4</sub>	0.53	0.53	0.0000	1.0000
1A2	Manufacturing industries and construction: other fuels	N <sub>2</sub> O	0.30	0.30	0.0000	1.0000
2B1	Ammonia production	CH <sub>4</sub>	0.29	0.29	0.0000	1.0000
2B1	Ammonia production	N <sub>2</sub> O	0.27	0.27	0.0000	1.0000
1A1	Energy industries: biomass	N <sub>2</sub> O	0.22	0.22	0.0000	1.0000
1A2	Manufacturing industries and construction: other fuels	CH <sub>4</sub>	0.17	0.17	0.0000	1.0000
1A3e	Other transportation: liquid fuels	CH <sub>4</sub>	0.14	0.14	0.0000	1.0000
1B1	Coal mining and handling	N <sub>2</sub> O	0.08	0.08	0.0000	1.0000
<b>Total</b>			<b>820,103.31</b>	<b>853,413.47</b>	<b>1.0000</b>	

**Table A 1.3.2 Approach 1 Key Category Analysis for the base year based on level of emissions (excluding LULUCF) – UNFCCC scope**

IPCC Code	IPCC Category	GHG	Base year emissions (Gg CO <sub>2</sub> e)	Absolute value of Base year emissions (Gg CO <sub>2</sub> e)	Level Assessment	Cumulative Total
1A1	Energy industries: solid fuels	CO <sub>2</sub>	185,488.39	185,488.39	0.2293	0.3643
1A3b	Road transportation: liquid fuels	CO <sub>2</sub>	109,173.97	109,173.97	0.1350	0.3643
1A4	Other sectors: gaseous fuels	CO <sub>2</sub>	70,371.86	70,371.86	0.0870	0.4512
5A	Solid waste disposal	CH <sub>4</sub>	67,633.35	67,633.35	0.0836	0.5349
1A1	Energy industries: liquid fuels	CO <sub>2</sub>	40,387.53	40,387.53	0.0499	0.5848
1A2	Manufacturing industries and construction: liquid fuels	CO <sub>2</sub>	27,665.96	27,665.96	0.0342	0.6190
1A2	Manufacturing industries and construction: gaseous fuels	CO <sub>2</sub>	27,291.18	27,291.18	0.0337	0.6527
1B1	Coal mining and handling	CH <sub>4</sub>	24,446.08	24,446.08	0.0302	0.6829
2C1	Iron and steel production	CO <sub>2</sub>	23,628.28	23,628.28	0.0292	0.7121
1A4	Other sectors: liquid fuels	CO <sub>2</sub>	21,465.76	21,465.76	0.0265	0.7387
3A1	Enteric fermentation from Cattle	CH <sub>4</sub>	21,166.02	21,166.02	0.0262	0.7648
1A2	Manufacturing industries and construction: solid fuels	CO <sub>2</sub>	20,209.42	20,209.42	0.0250	0.7898
1A4	Other sectors: solid fuels	CO <sub>2</sub>	19,824.90	19,824.90	0.0245	0.8143
2B3	Adipic acid production	N <sub>2</sub> O	17,727.08	17,727.08	0.0219	0.8362
2B9	Fluorochemical production	HFCs, PFCs, SF <sub>6</sub> and NF <sub>3</sub>	14,911.66	14,911.66	0.0184	0.8547
1B2	Oil and gas extraction	CH <sub>4</sub>	13,835.90	13,835.90	0.0171	0.8718
3D	Agricultural soils	N <sub>2</sub> O	13,428.41	13,428.41	0.0166	0.8884
1A1	Energy industries: gaseous fuels	CO <sub>2</sub>	11,939.20	11,939.20	0.0148	0.9031

IPCC Code	IPCC Category	GHG	Base year emissions (Gg CO <sub>2</sub> e)	Absolute value of Base year emissions (Gg CO <sub>2</sub> e)	Level Assessment	Cumulative Total
1A3d	Domestic Navigation: liquid fuels	CO <sub>2</sub>	7,611.13	7,611.13	0.0094	0.9125
2A1	Cement production	CO <sub>2</sub>	7,295.26	7,295.26	0.0090	0.9216
3A2	Enteric fermentation from Sheep	CH <sub>4</sub>	5,858.92	5,858.92	0.0072	0.9288
1A5	Other: liquid fuels	CO <sub>2</sub>	5,293.44	5,293.44	0.0065	0.9354
1B2	Oil and gas extraction	CO <sub>2</sub>	5,088.53	5,088.53	0.0063	0.9416
2B8	Petrochemical and carbon black production	CO <sub>2</sub>	4,751.56	4,751.56	0.0059	0.9475
3B1	Manure management from Cattle	CH <sub>4</sub>	4,646.15	4,646.15	0.0057	0.9533
2B2	Nitric acid production	N <sub>2</sub> O	3,432.78	3,432.78	0.0042	0.9575
3B2	Manure management from Sheep	N <sub>2</sub> O	3,038.90	3,038.90	0.0038	0.9613
5D	Wastewater treatment and discharge	CH <sub>4</sub>	2,365.31	2,365.31	0.0029	0.9642
2B1	Ammonia production	CO <sub>2</sub>	1,895.00	1,895.00	0.0023	0.9665
1A3a	Domestic aviation: liquid fuels	CO <sub>2</sub>	1,869.71	1,869.71	0.0023	0.9688
1B1	Coal mining and handling	CO <sub>2</sub>	1,698.56	1,698.56	0.0021	0.9709
1A3c	Railways: liquid fuels	CO <sub>2</sub>	1,469.34	1,469.34	0.0018	0.9728
5C	Incineration and open burning of waste	CO <sub>2</sub>	1,445.17	1,445.17	0.0018	0.9745
1A4	Other sectors: solid fuels	CH <sub>4</sub>	1,440.83	1,440.83	0.0018	0.9763
1A3b	Road transportation: liquid fuels	CH <sub>4</sub>	1,408.61	1,408.61	0.0017	0.9781
2C6	Zinc production	CO <sub>2</sub>	1,350.65	1,350.65	0.0017	0.9797
2A2	Lime production	CO <sub>2</sub>	1,328.60	1,328.60	0.0016	0.9814
2A4	Other process uses of carbonates	CO <sub>2</sub>	1,198.69	1,198.69	0.0015	0.9829

IPCC Code	IPCC Category	GHG	Base year emissions (Gg CO <sub>2</sub> e)	Absolute value of Base year emissions (Gg CO <sub>2</sub> e)	Level Assessment	Cumulative Total
1A3b	Road transportation: liquid fuels	N <sub>2</sub> O	1,176.81	1,176.81	0.0015	0.9843
3G	Liming	CO <sub>2</sub>	1,019.16	1,019.16	0.0013	0.9856
1A1	Energy industries: solid fuels	N <sub>2</sub> O	939.47	939.47	0.0012	0.9867
2G1	Electrical equipment	HFCs, PFCs, SF <sub>6</sub> and NF <sub>3</sub>	828.89	828.89	0.0010	0.9878
5D	Wastewater treatment and discharge	N <sub>2</sub> O	796.37	796.37	0.0010	0.9887
2D	Non-energy products from fuels and solvent use	CO <sub>2</sub>	552.81	552.81	0.0007	0.9894
2G3	N <sub>2</sub> O from product uses	N <sub>2</sub> O	493.41	493.41	0.0006	0.9900
1A4	Other sectors: peat	CO <sub>2</sub>	453.50	453.50	0.0006	0.9906
2C3	Aluminium production	CO <sub>2</sub>	450.32	450.32	0.0006	0.9912
2A3	Glass production	CO <sub>2</sub>	412.37	412.37	0.0005	0.9917
2F4	Aerosols	HFCs, PFCs, SF <sub>6</sub> and NF <sub>3</sub>	407.71	407.71	0.0005	0.9922
2C4	Magnesium production	HFCs, PFCs, SF <sub>6</sub> and NF <sub>3</sub>	399.06	399.06	0.0005	0.9927
3A4	Enteric fermentation from Other livestock	CH <sub>4</sub>	338.26	338.26	0.0004	0.9931
3A3	Enteric fermentation from Swine	CH <sub>4</sub>	317.02	317.02	0.0004	0.9935
3J	Agriculture activities in OTs and CDs	CH <sub>4</sub>	306.10	306.10	0.0004	0.9938
2C3	Aluminium production	HFCs, PFCs, SF <sub>6</sub> and NF <sub>3</sub>	299.84	299.84	0.0004	0.9942
3H	Urea application to land	CO <sub>2</sub>	293.75	293.75	0.0004	0.9946
1A1	Energy industries: other fuels	CO <sub>2</sub>	244.37	244.37	0.0003	0.9949

IPCC Code	IPCC Category	GHG	Base year emissions (Gg CO <sub>2</sub> e)	Absolute value of Base year emissions (Gg CO <sub>2</sub> e)	Level Assessment	Cumulative Total
1A1	Energy industries: gaseous fuels	N <sub>2</sub> O	232.10	232.10	0.0003	0.9952
2B7	Soda ash production	CO <sub>2</sub>	224.40	224.40	0.0003	0.9954
1A4	Other sectors: solid fuels	N <sub>2</sub> O	218.14	218.14	0.0003	0.9957
2B10	Other Chemical Industry	CH <sub>4</sub>	214.15	214.15	0.0003	0.9960
5C	Incineration and open burning of waste	CH <sub>4</sub>	213.78	213.78	0.0003	0.9962
3F	Field burning of agricultural residues	CH <sub>4</sub>	209.47	209.47	0.0003	0.9965
2F1	Refrigeration and air conditioning	HFCs, PFCs, SF <sub>6</sub> and NF <sub>3</sub>	201.39	201.39	0.0002	0.9968
2G2	SF <sub>6</sub> and PFCs from other product use	HFCs, PFCs, SF <sub>6</sub> and NF <sub>3</sub>	191.54	191.54	0.0002	0.9970
1A4	Other sectors: gaseous fuels	CH <sub>4</sub>	176.56	176.56	0.0002	0.9972
2F2	Foam blowing agents	HFCs, PFCs, SF <sub>6</sub> and NF <sub>3</sub>	167.80	167.80	0.0002	0.9974
3J	Agriculture activities in OTs and CDs	N <sub>2</sub> O	155.42	155.42	0.0002	0.9976
1A1	Energy industries: gaseous fuels	CH <sub>4</sub>	144.26	144.26	0.0002	0.9978
1A2	Manufacturing industries and construction: solid fuels	N <sub>2</sub> O	125.66	125.66	0.0002	0.9979
2B6	Titanium dioxide production	CO <sub>2</sub>	104.63	104.63	0.0001	0.9981
1A2	Manufacturing industries and construction: liquid fuels	N <sub>2</sub> O	102.15	102.15	0.0001	0.9982
1A4	Other sectors: biomass	CH <sub>4</sub>	100.88	100.88	0.0001	0.9983
1A1	Energy industries: liquid fuels	N <sub>2</sub> O	99.98	99.98	0.0001	0.9984
1A3e	Other transportation: liquid fuels	CO <sub>2</sub>	98.14	98.14	0.0001	0.9986
1A3d	Domestic Navigation: liquid fuels	N <sub>2</sub> O	93.38	93.38	0.0001	0.9987

IPCC Code	IPCC Category	GHG	Base year emissions (Gg CO <sub>2</sub> e)	Absolute value of Base year emissions (Gg CO <sub>2</sub> e)	Level Assessment	Cumulative Total
1A4	Other sectors: liquid fuels	N <sub>2</sub> O	83.51	83.51	0.0001	0.9988
1A4	Other sectors: liquid fuels	CH <sub>4</sub>	73.07	73.07	0.0001	0.9989
1A2	Manufacturing industries and construction: other fuels	CO <sub>2</sub>	70.61	70.61	0.0001	0.9990
5C	Incineration and open burning of waste	N <sub>2</sub> O	61.44	61.44	0.0001	0.9990
1A1	Energy industries: solid fuels	CH <sub>4</sub>	56.99	56.99	0.0001	0.9991
3F	Field burning of agricultural residues	N <sub>2</sub> O	51.40	51.40	0.0001	0.9992
1A2	Manufacturing industries and construction: solid fuels	CH <sub>4</sub>	50.06	50.06	0.0001	0.9992
1A5	Other: liquid fuels	N <sub>2</sub> O	49.91	49.91	0.0001	0.9993
2C1	Iron and steel production	CH <sub>4</sub>	43.92	43.92	0.0001	0.9994
2G4	Other product manufacture and use	N <sub>2</sub> O	40.20	40.20	0.0000	0.9994
1B2	Oil and gas extraction	N <sub>2</sub> O	39.74	39.74	0.0000	0.9995
1A1	Energy industries: liquid fuels	CH <sub>4</sub>	38.63	38.63	0.0000	0.9995
1A4	Other sectors: peat	CH <sub>4</sub>	35.94	35.94	0.0000	0.9995
1A2	Manufacturing industries and construction: liquid fuels	CH <sub>4</sub>	35.43	35.43	0.0000	0.9996
2A4	Other process uses of carbonates	CH <sub>4</sub>	34.84	34.84	0.0000	0.9996
2B8	Petrochemical and carbon black production	CH <sub>4</sub>	33.79	33.79	0.0000	0.9997
1A4	Other sectors: gaseous fuels	N <sub>2</sub> O	33.42	33.42	0.0000	0.9997
2F6	Other product uses as substitutes for ODS	HFCs, PFCs, SF <sub>6</sub> and NF <sub>3</sub>	23.59	23.59	0.0000	0.9997
5B	Biological treatment of solid waste	CH <sub>4</sub>	21.89	21.89	0.0000	0.9998
1A1	Energy industries: other fuels	CH <sub>4</sub>	20.77	20.77	0.0000	0.9998

IPCC Code	IPCC Category	GHG	Base year emissions (Gg CO <sub>2</sub> e)	Absolute value of Base year emissions (Gg CO <sub>2</sub> e)	Level Assessment	Cumulative Total
1A2	Manufacturing industries and construction: biomass	N <sub>2</sub> O	19.38	19.38	0.0000	0.9998
2C1	Iron and steel production	N <sub>2</sub> O	18.43	18.43	0.0000	0.9998
1A3a	Domestic aviation: liquid fuels	N <sub>2</sub> O	15.74	15.74	0.0000	0.9999
1A2	Manufacturing industries and construction: biomass	CH <sub>4</sub>	15.36	15.36	0.0000	0.9999
1A2	Manufacturing industries and construction: gaseous fuels	CH <sub>4</sub>	13.69	13.69	0.0000	0.9999
1A2	Manufacturing industries and construction: gaseous fuels	N <sub>2</sub> O	12.95	12.95	0.0000	0.9999
5B	Biological treatment of solid waste	N <sub>2</sub> O	12.36	12.36	0.0000	0.9999
1A4	Other sectors: biomass	N <sub>2</sub> O	12.04	12.04	0.0000	0.9999
2E1	Integrated circuit or semiconductor	HFCs, PFCs, SF <sub>6</sub> and NF <sub>3</sub>	11.10	11.10	0.0000	1.0000
1A3a	Domestic aviation: liquid fuels	CH <sub>4</sub>	7.69	7.69	0.0000	1.0000
1A1	Energy industries: other fuels	N <sub>2</sub> O	5.96	5.96	0.0000	1.0000
1A3d	Domestic Navigation: liquid fuels	CH <sub>4</sub>	4.10	4.10	0.0000	1.0000
1A5	Other: liquid fuels	CH <sub>4</sub>	3.98	3.98	0.0000	1.0000
1A3c	Railways: liquid fuels	N <sub>2</sub> O	2.93	2.93	0.0000	1.0000
1A3c	Railways: liquid fuels	CH <sub>4</sub>	2.75	2.75	0.0000	1.0000
2B8	Petrochemical and carbon black production	N <sub>2</sub> O	1.96	1.96	0.0000	1.0000
1A4	Other sectors: peat	N <sub>2</sub> O	1.59	1.59	0.0000	1.0000
2F3	Fire protection	HFCs, PFCs, SF <sub>6</sub> and NF <sub>3</sub>	1.47	1.47	0.0000	1.0000
1A3e	Other transportation: liquid fuels	N <sub>2</sub> O	1.05	1.05	0.0000	1.0000



IPCC Code	IPCC Category	GHG	Base year emissions (Gg CO <sub>2</sub> e)	Absolute value of Base year emissions (Gg CO <sub>2</sub> e)	Level Assessment	Cumulative Total
1A1	Energy industries: biomass	CH <sub>4</sub>	0.53	0.53	0.0000	1.0000
1A2	Manufacturing industries and construction: other fuels	N <sub>2</sub> O	0.30	0.30	0.0000	1.0000
2B1	Ammonia production	CH <sub>4</sub>	0.29	0.29	0.0000	1.0000
2B1	Ammonia production	N <sub>2</sub> O	0.27	0.27	0.0000	1.0000
1A1	Energy industries: biomass	N <sub>2</sub> O	0.22	0.22	0.0000	1.0000
1A2	Manufacturing industries and construction: other fuels	CH <sub>4</sub>	0.17	0.17	0.0000	1.0000
1A3e	Other transportation: liquid fuels	CH <sub>4</sub>	0.14	0.14	0.0000	1.0000
1B1	Coal mining and handling	N <sub>2</sub> O	0.08	0.08	0.0000	1.0000
<b>Total</b>			<b>808,950.83</b>	<b>808,950.83</b>	<b>1.0000</b>	

**Table A 1.3.3 Approach 1 Key Category Analysis for the latest reported year based on level of emissions (including LULUCF) – UNFCCC scope**

IPCC Code	IPCC Category	GHG	Latest reported year (LY) emissions (Gg CO <sub>2</sub> e)	Absolute value of LY emissions (Gg CO <sub>2</sub> e)	Level Assessment	Cumulative Total
1A3b	Road transportation: liquid fuels	CO <sub>2</sub>	99,276.69	99,276.69	0.2084	0.2084
1A4	Other sectors: gaseous fuels	CO <sub>2</sub>	76,850.07	76,850.07	0.1613	0.3697
1A1	Energy industries: gaseous fuels	CO <sub>2</sub>	54,199.83	54,199.83	0.1138	0.4835
1A2	Manufacturing industries and construction: gaseous fuels	CO <sub>2</sub>	24,871.53	24,871.53	0.0522	0.5357
3A1	Enteric fermentation from Cattle	CH <sub>4</sub>	18,085.60	18,085.60	0.0380	0.5737
4A	Forest land	CO <sub>2</sub>	-18,082.25	18,082.25	0.0380	0.6116

IPCC Code	IPCC Category	GHG	Latest reported year (LY) emissions (Gg CO <sub>2</sub> e)	Absolute value of LY emissions (Gg CO <sub>2</sub> e)	Level Assessment	Cumulative Total
1A2	Manufacturing industries and construction: liquid fuels	CO <sub>2</sub>	14,227.59	14,227.59	0.0299	0.6415
1A4	Other sectors: liquid fuels	CO <sub>2</sub>	13,868.78	13,868.78	0.0291	0.6706
5A	Solid waste disposal	CH <sub>4</sub>	13,777.09	13,777.09	0.0289	0.6995
4B	Cropland	CO <sub>2</sub>	12,690.21	12,690.21	0.0266	0.7262
1A1	Energy industries: liquid fuels	CO <sub>2</sub>	11,869.05	11,869.05	0.0249	0.7511
3D	Agricultural soils	N <sub>2</sub> O	10,999.18	10,999.18	0.0231	0.7742
2C1	Iron and steel production	CO <sub>2</sub>	10,605.21	10,605.21	0.0223	0.7964
2F1	Refrigeration and air conditioning	HFCs, PFCs, SF <sub>6</sub> and NF <sub>3</sub>	9,161.95	9,161.95	0.0192	0.8157
1A1	Energy industries: other fuels	CO <sub>2</sub>	6,559.20	6,559.20	0.0138	0.8294
1A1	Energy industries: solid fuels	CO <sub>2</sub>	6,414.00	6,414.00	0.0135	0.8429
1A3d	Domestic Navigation: liquid fuels	CO <sub>2</sub>	4,862.02	4,862.02	0.0102	0.8531
3A2	Enteric fermentation from Sheep	CH <sub>4</sub>	4,714.58	4,714.58	0.0099	0.8630
1B2	Oil and gas extraction	CH <sub>4</sub>	4,541.72	4,541.72	0.0095	0.8725
3B1	Manure management from Cattle	CH <sub>4</sub>	4,290.16	4,290.16	0.0090	0.8816
2A1	Cement production	CO <sub>2</sub>	4,215.15	4,215.15	0.0088	0.8904
4E	Settlements	CO <sub>2</sub>	3,799.29	3,799.29	0.0080	0.8984
1A2	Manufacturing industries and construction: solid fuels	CO <sub>2</sub>	3,482.14	3,482.14	0.0073	0.9057
4C	Grassland	CH <sub>4</sub>	2,861.40	2,861.40	0.0060	0.9117
4C	Grassland	CO <sub>2</sub>	-2,738.53	2,738.53	0.0057	0.9174
1B2	Oil and gas extraction	CO <sub>2</sub>	2,682.64	2,682.64	0.0056	0.9231

IPCC Code	IPCC Category	GHG	Latest reported year (LY) emissions (Gg CO <sub>2</sub> e)	Absolute value of LY emissions (Gg CO <sub>2</sub> e)	Level Assessment	Cumulative Total
3B2	Manure management from Sheep	N <sub>2</sub> O	2,493.71	2,493.71	0.0052	0.9283
4D	Wetlands	CH <sub>4</sub>	2,382.01	2,382.01	0.0050	0.9333
4G	Harvested wood products	CO <sub>2</sub>	-2,037.46	2,037.46	0.0043	0.9376
5D	Wastewater treatment and discharge	CH <sub>4</sub>	1,959.38	1,959.38	0.0041	0.9417
1A4	Other sectors: solid fuels	CO <sub>2</sub>	1,952.53	1,952.53	0.0041	0.9458
1A5	Other: liquid fuels	CO <sub>2</sub>	1,567.97	1,567.97	0.0033	0.9491
2B8	Petrochemical and carbon black production	CO <sub>2</sub>	1,529.70	1,529.70	0.0032	0.9523
1A3c	Railways: liquid fuels	CO <sub>2</sub>	1,522.80	1,522.80	0.0032	0.9555
5B	Biological treatment of solid waste	CH <sub>4</sub>	1,373.84	1,373.84	0.0029	0.9584
2B1	Ammonia production	CO <sub>2</sub>	1,178.74	1,178.74	0.0025	0.9609
3G	Liming	CO <sub>2</sub>	1,177.94	1,177.94	0.0025	0.9633
2A2	Lime production	CO <sub>2</sub>	1,092.26	1,092.26	0.0023	0.9656
2F4	Aerosols	HFCs, PFCs, SF <sub>6</sub> and NF <sub>3</sub>	942.13	942.13	0.0020	0.9676
5D	Wastewater treatment and discharge	N <sub>2</sub> O	903.51	903.51	0.0019	0.9695
1A3a	Domestic aviation: liquid fuels	CO <sub>2</sub>	897.03	897.03	0.0019	0.9714
1A3b	Road transportation: liquid fuels	N <sub>2</sub> O	880.35	880.35	0.0018	0.9732
1A2	Manufacturing industries and construction: other fuels	CO <sub>2</sub>	683.27	683.27	0.0014	0.9747
5B	Biological treatment of solid waste	N <sub>2</sub> O	660.50	660.50	0.0014	0.9760
2G3	N <sub>2</sub> O from product uses	N <sub>2</sub> O	593.71	593.71	0.0012	0.9773
4D	Wetlands	CO <sub>2</sub>	550.11	550.11	0.0012	0.9785

IPCC Code	IPCC Category	GHG	Latest reported year (LY) emissions (Gg CO <sub>2</sub> e)	Absolute value of LY emissions (Gg CO <sub>2</sub> e)	Level Assessment	Cumulative Total
3A4	Enteric fermentation from Other livestock	CH <sub>4</sub>	521.04	521.04	0.0011	0.9795
1B1	Coal mining and handling	CH <sub>4</sub>	514.50	514.50	0.0011	0.9806
2A4	Other process uses of carbonates	CO <sub>2</sub>	423.46	423.46	0.0009	0.9815
2D	Non-energy products from fuels and solvent use	CO <sub>2</sub>	402.41	402.41	0.0008	0.9824
4A	Forest land	N <sub>2</sub> O	377.40	377.40	0.0008	0.9832
4B	Cropland	N <sub>2</sub> O	354.68	354.68	0.0007	0.9839
2F2	Foam blowing agents	HFCs, PFCs, SF <sub>6</sub> and NF <sub>3</sub>	353.92	353.92	0.0007	0.9846
2A3	Glass production	CO <sub>2</sub>	340.25	340.25	0.0007	0.9854
5C	Incineration and open burning of waste	CO <sub>2</sub>	335.70	335.70	0.0007	0.9861
1A4	Other sectors: biomass	CH <sub>4</sub>	335.24	335.24	0.0007	0.9868
2G1	Electrical equipment	HFCs, PFCs, SF <sub>6</sub> and NF <sub>3</sub>	330.09	330.09	0.0007	0.9875
4B	Cropland	CH <sub>4</sub>	317.96	317.96	0.0007	0.9881
2F3	Fire protection	HFCs, PFCs, SF <sub>6</sub> and NF <sub>3</sub>	293.92	293.92	0.0006	0.9887
4E	Settlements	N <sub>2</sub> O	254.78	254.78	0.0005	0.9893
3H	Urea application to land	CO <sub>2</sub>	252.57	252.57	0.0005	0.9898
3J	Agriculture activities in OTs and CDs	CH <sub>4</sub>	228.23	228.23	0.0005	0.9903
3A3	Enteric fermentation from Swine	CH <sub>4</sub>	223.56	223.56	0.0005	0.9908
1A1	Energy industries: gaseous fuels	N <sub>2</sub> O	215.74	215.74	0.0005	0.9912
1A1	Energy industries: biomass	N <sub>2</sub> O	205.14	205.14	0.0004	0.9916

IPCC Code	IPCC Category	GHG	Latest reported year (LY) emissions (Gg CO <sub>2</sub> e)	Absolute value of LY emissions (Gg CO <sub>2</sub> e)	Level Assessment	Cumulative Total
1B1	Coal mining and handling	CO <sub>2</sub>	203.99	203.99	0.0004	0.9921
1A4	Other sectors: gaseous fuels	CH <sub>4</sub>	191.50	191.50	0.0004	0.9925
1A3b	Road transportation: gaseous fuels	CO <sub>2</sub>	178.51	178.51	0.0004	0.9928
1A3b	Road transportation: biomass	CO <sub>2</sub>	166.35	166.35	0.0003	0.9932
1A4	Other sectors: solid fuels	CH <sub>4</sub>	166.31	166.31	0.0003	0.9935
1A1	Energy industries: biomass	CH <sub>4</sub>	163.29	163.29	0.0003	0.9939
1A1	Energy industries: other fuels	CH <sub>4</sub>	161.15	161.15	0.0003	0.9942
2B6	Titanium dioxide production	CO <sub>2</sub>	155.29	155.29	0.0003	0.9945
4	Indirect N <sub>2</sub> O emissions from LULUCF	N <sub>2</sub> O	152.89	152.89	0.0003	0.9949
2B7	Soda ash production	CO <sub>2</sub>	131.33	131.33	0.0003	0.9951
1A3e	Other transportation: liquid fuels	CO <sub>2</sub>	129.66	129.66	0.0003	0.9954
4C	Grassland	N <sub>2</sub> O	127.67	127.67	0.0003	0.9957
2G2	SF <sub>6</sub> and PFCs from other product use	HFCs, PFCs, SF <sub>6</sub> and NF <sub>3</sub>	121.01	121.01	0.0003	0.9959
2B9	Fluorochemical production	HFCs, PFCs, SF <sub>6</sub> and NF <sub>3</sub>	120.85	120.85	0.0003	0.9962
1A2	Manufacturing industries and construction: biomass	N <sub>2</sub> O	113.93	113.93	0.0002	0.9964
1A1	Energy industries: other fuels	N <sub>2</sub> O	111.67	111.67	0.0002	0.9967
4A	Forest land	CH <sub>4</sub>	104.50	104.50	0.0002	0.9969
3J	Agriculture activities in OTs and CDs	N <sub>2</sub> O	103.91	103.91	0.0002	0.9971
1A1	Energy industries: gaseous fuels	CH <sub>4</sub>	98.42	98.42	0.0002	0.9973

IPCC Code	IPCC Category	GHG	Latest reported year (LY) emissions (Gg CO <sub>2</sub> e)	Absolute value of LY emissions (Gg CO <sub>2</sub> e)	Level Assessment	Cumulative Total
1A2	Manufacturing industries and construction: biomass	CH <sub>4</sub>	90.53	90.53	0.0002	0.9975
1A3b	Road transportation: liquid fuels	CH <sub>4</sub>	82.08	82.08	0.0002	0.9977
1A4	Other sectors: liquid fuels	N <sub>2</sub> O	81.50	81.50	0.0002	0.9978
1A2	Manufacturing industries and construction: liquid fuels	N <sub>2</sub> O	74.24	74.24	0.0002	0.9980
2G4	Other product manufacture and use	N <sub>2</sub> O	72.46	72.46	0.0002	0.9981
5C	Incineration and open burning of waste	CH <sub>4</sub>	59.15	59.15	0.0001	0.9983
2C3	Aluminium production	CO <sub>2</sub>	57.94	57.94	0.0001	0.9984
1A3d	Domestic Navigation: liquid fuels	N <sub>2</sub> O	56.78	56.78	0.0001	0.9985
1A1	Energy industries: liquid fuels	N <sub>2</sub> O	44.07	44.07	0.0001	0.9986
1A4	Other sectors: biomass	N <sub>2</sub> O	41.07	41.07	0.0001	0.9987
2C4	Magnesium production	HFCs, PFCs, SF <sub>6</sub> and NF <sub>3</sub>	40.68	40.68	0.0001	0.9988
1A3c	Railways: solid fuels	CO <sub>2</sub>	38.41	38.41	0.0001	0.9989
1A4	Other sectors: gaseous fuels	N <sub>2</sub> O	36.25	36.25	0.0001	0.9989
5C	Incineration and open burning of waste	N <sub>2</sub> O	35.35	35.35	0.0001	0.9990
1A4	Other sectors: liquid fuels	CH <sub>4</sub>	31.09	31.09	0.0001	0.9991
2B10	Other Chemical Industry	CH <sub>4</sub>	30.69	30.69	0.0001	0.9991
2F6	Other product uses as substitutes for ODS	HFCs, PFCs, SF <sub>6</sub> and NF <sub>3</sub>	30.08	30.08	0.0001	0.9992
1A1	Energy industries: solid fuels	N <sub>2</sub> O	29.27	29.27	0.0001	0.9993
4E	Settlements	CH <sub>4</sub>	28.19	28.19	0.0001	0.9993

IPCC Code	IPCC Category	GHG	Latest reported year (LY) emissions (Gg CO <sub>2</sub> e)	Absolute value of LY emissions (Gg CO <sub>2</sub> e)	Level Assessment	Cumulative Total
2B2	Nitric acid production	N <sub>2</sub> O	28.09	28.09	0.0001	0.9994
1A2	Manufacturing industries and construction: solid fuels	N <sub>2</sub> O	24.82	24.82	0.0001	0.9994
1A4	Other sectors: solid fuels	N <sub>2</sub> O	23.16	23.16	0.0000	0.9995
1B2	Oil and gas extraction	N <sub>2</sub> O	22.21	22.21	0.0000	0.9995
4D	Wetlands	N <sub>2</sub> O	21.42	21.42	0.0000	0.9996
2E1	Integrated circuit or semiconductor	HFCs, PFCs, SF <sub>6</sub> and NF <sub>3</sub>	19.44	19.44	0.0000	0.9996
2F5	Solvents	HFCs, PFCs, SF <sub>6</sub> and NF <sub>3</sub>	16.35	16.35	0.0000	0.9996
1A5	Other: liquid fuels	N <sub>2</sub> O	15.03	15.03	0.0000	0.9997
1A2	Manufacturing industries and construction: liquid fuels	CH <sub>4</sub>	14.75	14.75	0.0000	0.9997
2C1	Iron and steel production	CH <sub>4</sub>	12.93	12.93	0.0000	0.9997
1A2	Manufacturing industries and construction: gaseous fuels	CH <sub>4</sub>	12.40	12.40	0.0000	0.9998
1A2	Manufacturing industries and construction: gaseous fuels	N <sub>2</sub> O	11.73	11.73	0.0000	0.9998
1A2	Manufacturing industries and construction: solid fuels	CH <sub>4</sub>	10.29	10.29	0.0000	0.9998
2B8	Petrochemical and carbon black production	CH <sub>4</sub>	9.90	9.90	0.0000	0.9998
1A2	Manufacturing industries and construction: other fuels	N <sub>2</sub> O	9.18	9.18	0.0000	0.9999
1A1	Energy industries: liquid fuels	CH <sub>4</sub>	8.73	8.73	0.0000	0.9999
1A4	Other sectors: peat	CO <sub>2</sub>	7.71	7.71	0.0000	0.9999
1A3a	Domestic aviation: liquid fuels	N <sub>2</sub> O	7.55	7.55	0.0000	0.9999
1A3d	Domestic Navigation: liquid fuels	CH <sub>4</sub>	7.39	7.39	0.0000	0.9999

IPCC Code	IPCC Category	GHG	Latest reported year (LY) emissions (Gg CO <sub>2</sub> e)	Absolute value of LY emissions (Gg CO <sub>2</sub> e)	Level Assessment	Cumulative Total
1A2	Manufacturing industries and construction: other fuels	CH <sub>4</sub>	7.04	7.04	0.0000	0.9999
2C1	Iron and steel production	N <sub>2</sub> O	6.54	6.54	0.0000	0.9999
2A4	Other process uses of carbonates	CH <sub>4</sub>	4.75	4.75	0.0000	1.0000
1A3b	Road transportation: gaseous fuels	CH <sub>4</sub>	4.73	4.73	0.0000	1.0000
2C3	Aluminium production	HFCs, PFCs, SF <sub>6</sub> and NF <sub>3</sub>	4.32	4.32	0.0000	1.0000
1A3c	Railways: liquid fuels	N <sub>2</sub> O	3.04	3.04	0.0000	1.0000
1A1	Energy industries: solid fuels	CH <sub>4</sub>	1.90	1.90	0.0000	1.0000
1A3e	Other transportation: liquid fuels	N <sub>2</sub> O	1.47	1.47	0.0000	1.0000
1A3a	Domestic aviation: liquid fuels	CH <sub>4</sub>	1.18	1.18	0.0000	1.0000
1A5	Other: liquid fuels	CH <sub>4</sub>	1.10	1.10	0.0000	1.0000
1A3c	Railways: solid fuels	CH <sub>4</sub>	0.98	0.98	0.0000	1.0000
2B8	Petrochemical and carbon black production	N <sub>2</sub> O	0.74	0.74	0.0000	1.0000
1A4	Other sectors: peat	CH <sub>4</sub>	0.61	0.61	0.0000	1.0000
1A3c	Railways: liquid fuels	CH <sub>4</sub>	0.54	0.54	0.0000	1.0000
2B1	Ammonia production	CH <sub>4</sub>	0.23	0.23	0.0000	1.0000
2B1	Ammonia production	N <sub>2</sub> O	0.22	0.22	0.0000	1.0000
1A3b	Road transportation: gaseous fuels	N <sub>2</sub> O	0.08	0.08	0.0000	1.0000
1A3c	Railways: solid fuels	N <sub>2</sub> O	0.07	0.07	0.0000	1.0000
1A4	Other sectors: peat	N <sub>2</sub> O	0.03	0.03	0.0000	1.0000
1A3e	Other transportation: liquid fuels	CH <sub>4</sub>	0.02	0.02	0.0000	1.0000



IPCC Code	IPCC Category	GHG	Latest reported year (LY) emissions (Gg CO <sub>2</sub> e)	Absolute value of LY emissions (Gg CO <sub>2</sub> e)	Level Assessment	Cumulative Total
1B1	Coal mining and handling	N <sub>2</sub> O	0.02	0.02	0.0000	1.0000
<b>Total</b>			<b>430,653.74</b>	<b>476,370.21</b>	<b>1.0000</b>	

**Table A 1.3.4 Approach 1 Key Category Analysis for the latest reported year based on level of emissions (excluding LULUCF) – UNFCCC scope**

IPCC Code	IPCC Category	GHG	Latest reported year (LY) emissions (Gg CO <sub>2</sub> e)	Absolute value of LY emissions (Gg CO <sub>2</sub> e)	Level Assessment	Cumulative Total
1A3b	Road transportation: liquid fuels	CO <sub>2</sub>	99,276.69	99,276.69	0.2312	0.2312
1A4	Other sectors: gaseous fuels	CO <sub>2</sub>	76,850.07	76,850.07	0.1789	0.4101
1A1	Energy industries: gaseous fuels	CO <sub>2</sub>	54,199.83	54,199.83	0.1262	0.5363
1A2	Manufacturing industries and construction: gaseous fuels	CO <sub>2</sub>	24,871.53	24,871.53	0.0579	0.5942
3A1	Enteric fermentation from Cattle	CH <sub>4</sub>	18,085.60	18,085.60	0.0421	0.6363
1A2	Manufacturing industries and construction: liquid fuels	CO <sub>2</sub>	14,227.59	14,227.59	0.0331	0.6694
1A4	Other sectors: liquid fuels	CO <sub>2</sub>	13,868.78	13,868.78	0.0323	0.7017
5A	Solid waste disposal	CH <sub>4</sub>	13,777.09	13,777.09	0.0321	0.7338
1A1	Energy industries: liquid fuels	CO <sub>2</sub>	11,869.05	11,869.05	0.0276	0.7614
3D	Agricultural soils	N <sub>2</sub> O	10,999.18	10,999.18	0.0256	0.7870
2C1	Iron and steel production	CO <sub>2</sub>	10,605.21	10,605.21	0.0247	0.8117
2F1	Refrigeration and air conditioning	HFCs, PFCs, SF <sub>6</sub> and NF <sub>3</sub>	9,161.95	9,161.95	0.0213	0.8331
1A1	Energy industries: other fuels	CO <sub>2</sub>	6,559.20	6,559.20	0.0153	0.8483

IPCC Code	IPCC Category	GHG	Latest reported year (LY) emissions (Gg CO <sub>2</sub> e)	Absolute value of LY emissions (Gg CO <sub>2</sub> e)	Level Assessment	Cumulative Total
1A1	Energy industries: solid fuels	CO <sub>2</sub>	6,414.00	6,414.00	0.0149	0.8633
1A3d	Domestic Navigation: liquid fuels	CO <sub>2</sub>	4,862.02	4,862.02	0.0113	0.8746
3A2	Enteric fermentation from Sheep	CH <sub>4</sub>	4,714.58	4,714.58	0.0110	0.8856
1B2	Oil and gas extraction	CH <sub>4</sub>	4,541.72	4,541.72	0.0106	0.8961
3B1	Manure management from Cattle	CH <sub>4</sub>	4,290.16	4,290.16	0.0100	0.9061
2A1	Cement production	CO <sub>2</sub>	4,215.15	4,215.15	0.0098	0.9159
1A2	Manufacturing industries and construction: solid fuels	CO <sub>2</sub>	3,482.14	3,482.14	0.0081	0.9241
1B2	Oil and gas extraction	CO <sub>2</sub>	2,682.64	2,682.64	0.0062	0.9303
3B2	Manure management from Sheep	N <sub>2</sub> O	2,493.71	2,493.71	0.0058	0.9361
5D	Wastewater treatment and discharge	CH <sub>4</sub>	1,959.38	1,959.38	0.0046	0.9407
1A4	Other sectors: solid fuels	CO <sub>2</sub>	1,952.53	1,952.53	0.0045	0.9452
1A5	Other: liquid fuels	CO <sub>2</sub>	1,567.97	1,567.97	0.0037	0.9489
2B8	Petrochemical and carbon black production	CO <sub>2</sub>	1,529.70	1,529.70	0.0036	0.9524
1A3c	Railways: liquid fuels	CO <sub>2</sub>	1,522.80	1,522.80	0.0035	0.9560
5B	Biological treatment of solid waste	CH <sub>4</sub>	1,373.84	1,373.84	0.0032	0.9592
2B1	Ammonia production	CO <sub>2</sub>	1,178.74	1,178.74	0.0027	0.9619
3G	Liming	CO <sub>2</sub>	1,177.94	1,177.94	0.0027	0.9647
2A2	Lime production	CO <sub>2</sub>	1,092.26	1,092.26	0.0025	0.9672
2F4	Aerosols	HFCs, PFCs, SF <sub>6</sub> and NF <sub>3</sub>	942.13	942.13	0.0022	0.9694
5D	Wastewater treatment and discharge	N <sub>2</sub> O	903.51	903.51	0.0021	0.9715

IPCC Code	IPCC Category	GHG	Latest reported year (LY) emissions (Gg CO <sub>2</sub> e)	Absolute value of LY emissions (Gg CO <sub>2</sub> e)	Level Assessment	Cumulative Total
1A3a	Domestic aviation: liquid fuels	CO <sub>2</sub>	897.03	897.03	0.0021	0.9736
1A3b	Road transportation: liquid fuels	N <sub>2</sub> O	880.35	880.35	0.0020	0.9756
1A2	Manufacturing industries and construction: other fuels	CO <sub>2</sub>	683.27	683.27	0.0016	0.9772
5B	Biological treatment of solid waste	N <sub>2</sub> O	660.50	660.50	0.0015	0.9788
2G3	N <sub>2</sub> O from product uses	N <sub>2</sub> O	593.71	593.71	0.0014	0.9801
3A4	Enteric fermentation from Other livestock	CH <sub>4</sub>	521.04	521.04	0.0012	0.9814
1B1	Coal mining and handling	CH <sub>4</sub>	514.50	514.50	0.0012	0.9826
2A4	Other process uses of carbonates	CO <sub>2</sub>	423.46	423.46	0.0010	0.9835
2D	Non-energy products from fuels and solvent use	CO <sub>2</sub>	402.41	402.41	0.0009	0.9845
2F2	Foam blowing agents	HFCs, PFCs, SF <sub>6</sub> and NF <sub>3</sub>	353.92	353.92	0.0008	0.9853
2A3	Glass production	CO <sub>2</sub>	340.25	340.25	0.0008	0.9861
5C	Incineration and open burning of waste	CO <sub>2</sub>	335.70	335.70	0.0008	0.9869
1A4	Other sectors: biomass	CH <sub>4</sub>	335.24	335.24	0.0008	0.9877
2G1	Electrical equipment	HFCs, PFCs, SF <sub>6</sub> and NF <sub>3</sub>	330.09	330.09	0.0008	0.9884
2F3	Fire protection	HFCs, PFCs, SF <sub>6</sub> and NF <sub>3</sub>	293.92	293.92	0.0007	0.9891
3H	Urea application to land	CO <sub>2</sub>	252.57	252.57	0.0006	0.9897
3J	Agriculture activities in OTs and CDs	CH <sub>4</sub>	228.23	228.23	0.0005	0.9902
3A3	Enteric fermentation from Swine	CH <sub>4</sub>	223.56	223.56	0.0005	0.9908
1A1	Energy industries: gaseous fuels	N <sub>2</sub> O	215.74	215.74	0.0005	0.9913

IPCC Code	IPCC Category	GHG	Latest reported year (LY) emissions (Gg CO <sub>2</sub> e)	Absolute value of LY emissions (Gg CO <sub>2</sub> e)	Level Assessment	Cumulative Total
1A1	Energy industries: biomass	N <sub>2</sub> O	205.14	205.14	0.0005	0.9917
1B1	Coal mining and handling	CO <sub>2</sub>	203.99	203.99	0.0005	0.9922
1A4	Other sectors: gaseous fuels	CH <sub>4</sub>	191.50	191.50	0.0004	0.9927
1A3b	Road transportation: gaseous fuels	CO <sub>2</sub>	178.51	178.51	0.0004	0.9931
1A3b	Road transportation: biomass	CO <sub>2</sub>	166.35	166.35	0.0004	0.9935
1A4	Other sectors: solid fuels	CH <sub>4</sub>	166.31	166.31	0.0004	0.9938
1A1	Energy industries: biomass	CH <sub>4</sub>	163.29	163.29	0.0004	0.9942
1A1	Energy industries: other fuels	CH <sub>4</sub>	161.15	161.15	0.0004	0.9946
2B6	Titanium dioxide production	CO <sub>2</sub>	155.29	155.29	0.0004	0.9950
2B7	Soda ash production	CO <sub>2</sub>	131.33	131.33	0.0003	0.9953
1A3e	Other transportation: liquid fuels	CO <sub>2</sub>	129.66	129.66	0.0003	0.9956
2G2	SF <sub>6</sub> and PFCs from other product use	HFCs, PFCs, SF <sub>6</sub> and NF <sub>3</sub>	121.01	121.01	0.0003	0.9959
2B9	Fluorochemical production	HFCs, PFCs, SF <sub>6</sub> and NF <sub>3</sub>	120.85	120.85	0.0003	0.9961
1A2	Manufacturing industries and construction: biomass	N <sub>2</sub> O	113.93	113.93	0.0003	0.9964
1A1	Energy industries: other fuels	N <sub>2</sub> O	111.67	111.67	0.0003	0.9967
3J	Agriculture activities in OTs and CDs	N <sub>2</sub> O	103.91	103.91	0.0002	0.9969
1A1	Energy industries: gaseous fuels	CH <sub>4</sub>	98.42	98.42	0.0002	0.9971
1A2	Manufacturing industries and construction: biomass	CH <sub>4</sub>	90.53	90.53	0.0002	0.9973
1A3b	Road transportation: liquid fuels	CH <sub>4</sub>	82.08	82.08	0.0002	0.9975

IPCC Code	IPCC Category	GHG	Latest reported year (LY) emissions (Gg CO <sub>2</sub> e)	Absolute value of LY emissions (Gg CO <sub>2</sub> e)	Level Assessment	Cumulative Total
1A4	Other sectors: liquid fuels	N <sub>2</sub> O	81.50	81.50	0.0002	0.9977
1A2	Manufacturing industries and construction: liquid fuels	N <sub>2</sub> O	74.24	74.24	0.0002	0.9979
2G4	Other product manufacture and use	N <sub>2</sub> O	72.46	72.46	0.0002	0.9981
5C	Incineration and open burning of waste	CH <sub>4</sub>	59.15	59.15	0.0001	0.9982
2C3	Aluminium production	CO <sub>2</sub>	57.94	57.94	0.0001	0.9983
1A3d	Domestic Navigation: liquid fuels	N <sub>2</sub> O	56.78	56.78	0.0001	0.9985
1A1	Energy industries: liquid fuels	N <sub>2</sub> O	44.07	44.07	0.0001	0.9986
1A4	Other sectors: biomass	N <sub>2</sub> O	41.07	41.07	0.0001	0.9987
2C4	Magnesium production	HFCs, PFCs, SF <sub>6</sub> and NF <sub>3</sub>	40.68	40.68	0.0001	0.9988
1A3c	Railways: solid fuels	CO <sub>2</sub>	38.41	38.41	0.0001	0.9988
1A4	Other sectors: gaseous fuels	N <sub>2</sub> O	36.25	36.25	0.0001	0.9989
5C	Incineration and open burning of waste	N <sub>2</sub> O	35.35	35.35	0.0001	0.9990
1A4	Other sectors: liquid fuels	CH <sub>4</sub>	31.09	31.09	0.0001	0.9991
2B10	Other Chemical Industry	CH <sub>4</sub>	30.69	30.69	0.0001	0.9992
2F6	Other product uses as substitutes for ODS	HFCs, PFCs, SF <sub>6</sub> and NF <sub>3</sub>	30.08	30.08	0.0001	0.9992
1A1	Energy industries: solid fuels	N <sub>2</sub> O	29.27	29.27	0.0001	0.9993
2B2	Nitric acid production	N <sub>2</sub> O	28.09	28.09	0.0001	0.9994
1A2	Manufacturing industries and construction: solid fuels	N <sub>2</sub> O	24.82	24.82	0.0001	0.9994
1A4	Other sectors: solid fuels	N <sub>2</sub> O	23.16	23.16	0.0001	0.9995

IPCC Code	IPCC Category	GHG	Latest reported year (LY) emissions (Gg CO <sub>2</sub> e)	Absolute value of LY emissions (Gg CO <sub>2</sub> e)	Level Assessment	Cumulative Total
1B2	Oil and gas extraction	N <sub>2</sub> O	22.21	22.21	0.0001	0.9995
2E1	Integrated circuit or semiconductor	HFCs, PFCs, SF <sub>6</sub> and NF <sub>3</sub>	19.44	19.44	0.0000	0.9996
2F5	Solvents	HFCs, PFCs, SF <sub>6</sub> and NF <sub>3</sub>	16.35	16.35	0.0000	0.9996
1A5	Other: liquid fuels	N <sub>2</sub> O	15.03	15.03	0.0000	0.9996
1A2	Manufacturing industries and construction: liquid fuels	CH <sub>4</sub>	14.75	14.75	0.0000	0.9997
2C1	Iron and steel production	CH <sub>4</sub>	12.93	12.93	0.0000	0.9997
1A2	Manufacturing industries and construction: gaseous fuels	CH <sub>4</sub>	12.40	12.40	0.0000	0.9997
1A2	Manufacturing industries and construction: gaseous fuels	N <sub>2</sub> O	11.73	11.73	0.0000	0.9998
1A2	Manufacturing industries and construction: solid fuels	CH <sub>4</sub>	10.29	10.29	0.0000	0.9998
2B8	Petrochemical and carbon black production	CH <sub>4</sub>	9.90	9.90	0.0000	0.9998
1A2	Manufacturing industries and construction: other fuels	N <sub>2</sub> O	9.18	9.18	0.0000	0.9998
1A1	Energy industries: liquid fuels	CH <sub>4</sub>	8.73	8.73	0.0000	0.9999
1A4	Other sectors: peat	CO <sub>2</sub>	7.71	7.71	0.0000	0.9999
1A3a	Domestic aviation: liquid fuels	N <sub>2</sub> O	7.55	7.55	0.0000	0.9999
1A3d	Domestic Navigation: liquid fuels	CH <sub>4</sub>	7.39	7.39	0.0000	0.9999
1A2	Manufacturing industries and construction: other fuels	CH <sub>4</sub>	7.04	7.04	0.0000	0.9999
2C1	Iron and steel production	N <sub>2</sub> O	6.54	6.54	0.0000	0.9999
2A4	Other process uses of carbonates	CH <sub>4</sub>	4.75	4.75	0.0000	1.0000
1A3b	Road transportation: gaseous fuels	CH <sub>4</sub>	4.73	4.73	0.0000	1.0000

IPCC Code	IPCC Category	GHG	Latest reported year (LY) emissions (Gg CO <sub>2</sub> e)	Absolute value of LY emissions (Gg CO <sub>2</sub> e)	Level Assessment	Cumulative Total
2C3	Aluminium production	HFCs, PFCs, SF <sub>6</sub> and NF <sub>3</sub>	4.32	4.32	0.0000	1.0000
1A3c	Railways: liquid fuels	N <sub>2</sub> O	3.04	3.04	0.0000	1.0000
1A1	Energy industries: solid fuels	CH <sub>4</sub>	1.90	1.90	0.0000	1.0000
1A3e	Other transportation: liquid fuels	N <sub>2</sub> O	1.47	1.47	0.0000	1.0000
1A3a	Domestic aviation: liquid fuels	CH <sub>4</sub>	1.18	1.18	0.0000	1.0000
1A5	Other: liquid fuels	CH <sub>4</sub>	1.10	1.10	0.0000	1.0000
1A3c	Railways: solid fuels	CH <sub>4</sub>	0.98	0.98	0.0000	1.0000
2B8	Petrochemical and carbon black production	N <sub>2</sub> O	0.74	0.74	0.0000	1.0000
1A4	Other sectors: peat	CH <sub>4</sub>	0.61	0.61	0.0000	1.0000
1A3c	Railways: liquid fuels	CH <sub>4</sub>	0.54	0.54	0.0000	1.0000
2B1	Ammonia production	CH <sub>4</sub>	0.23	0.23	0.0000	1.0000
2B1	Ammonia production	N <sub>2</sub> O	0.22	0.22	0.0000	1.0000
1A3b	Road transportation: gaseous fuels	N <sub>2</sub> O	0.08	0.08	0.0000	1.0000
1A3c	Railways: solid fuels	N <sub>2</sub> O	0.07	0.07	0.0000	1.0000
1A4	Other sectors: peat	N <sub>2</sub> O	0.03	0.03	0.0000	1.0000
1A3e	Other transportation: liquid fuels	CH <sub>4</sub>	0.02	0.02	0.0000	1.0000
1B1	Coal mining and handling	N <sub>2</sub> O	0.02	0.02	0.0000	1.0000
<b>Total</b>			<b>429,489.47</b>	<b>429,489.47</b>	<b>1.0000</b>	

**Table A 1.3.5 Approach 1 Key Category Analysis based on trend in emissions (from base year to latest reported year, including LULUCF) – UNFCCC scope**

IPCC Code	IPCC Category	GHG	Base year emissions (Gg CO <sub>2</sub> e)	Latest reported year (LY) emissions (Gg CO <sub>2</sub> e)	Trend Assessment	Contribution to Trend	Cumulative Total
1A1	Energy industries: solid fuels	CO <sub>2</sub>	185,488.39	6,414.00	0.1066	0.2385	0.2385
1A1	Energy industries: gaseous fuels	CO <sub>2</sub>	11,939.20	54,199.83	0.0562	0.1257	0.3642
1A3b	Road transportation: liquid fuels	CO <sub>2</sub>	109,173.97	99,276.69	0.0492	0.1100	0.4742
1A4	Other sectors: gaseous fuels	CO <sub>2</sub>	70,371.86	76,850.07	0.0467	0.1046	0.5788
5A	Solid waste disposal	CH <sub>4</sub>	67,633.35	13,777.09	0.0255	0.0570	0.6358
1B1	Coal mining and handling	CH <sub>4</sub>	24,446.08	514.50	0.0144	0.0323	0.6681
1A2	Manufacturing industries and construction: gaseous fuels	CO <sub>2</sub>	27,291.18	24,871.53	0.0124	0.0276	0.6957
1A1	Energy industries: liquid fuels	CO <sub>2</sub>	40,387.53	11,869.05	0.0109	0.0245	0.7202
2B3	Adipic acid production	N <sub>2</sub> O	17,727.08	-	0.0109	0.0244	0.7446
2F1	Refrigeration and air conditioning	HFCs, PFCs, SF <sub>6</sub> and NF <sub>3</sub>	201.39	9,161.95	0.0106	0.0237	0.7683
1A4	Other sectors: solid fuels	CO <sub>2</sub>	19,824.90	1,952.53	0.0099	0.0222	0.7905
2B9	Fluorochemical production	HFCs, PFCs, SF <sub>6</sub> and NF <sub>3</sub>	14,911.66	120.85	0.0090	0.0202	0.8107
1A2	Manufacturing industries and construction: solid fuels	CO <sub>2</sub>	20,209.42	3,482.14	0.0084	0.0187	0.8294
3A1	Enteric fermentation from Cattle	CH <sub>4</sub>	21,166.02	18,085.60	0.0082	0.0183	0.8477
1A1	Energy industries: other fuels	CO <sub>2</sub>	244.37	6,559.20	0.0075	0.0169	0.8645
4B	Cropland	CO <sub>2</sub>	14,230.88	12,690.21	0.0061	0.0137	0.8782



IPCC Code	IPCC Category	GHG	Base year emissions (Gg CO <sub>2</sub> e)	Latest reported year (LY) emissions (Gg CO <sub>2</sub> e)	Trend Assessment	Contribution to Trend	Cumulative Total
3D	Agricultural soils	N <sub>2</sub> O	13,428.41	10,999.18	0.0046	0.0103	0.8886
1B2	Oil and gas extraction	CH <sub>4</sub>	13,835.90	4,541.72	0.0032	0.0071	0.8957
1A4	Other sectors: liquid fuels	CO <sub>2</sub>	21,465.76	13,868.78	0.0030	0.0068	0.9025
4A	Forest land	CO <sub>2</sub>	-13,940.16	-18,082.25	0.0029	0.0065	0.9090
3B1	Manure management from Cattle	CH <sub>4</sub>	4,646.15	4,290.16	0.0022	0.0049	0.9139
4C	Grassland	CO <sub>2</sub>	-618.75	-2,738.53	0.0021	0.0048	0.9186
2C1	Iron and steel production	CO <sub>2</sub>	23,628.28	10,605.21	0.0021	0.0047	0.9234
2B2	Nitric acid production	N <sub>2</sub> O	3,432.78	28.09	0.0021	0.0047	0.9280
3A2	Enteric fermentation from Sheep	CH <sub>4</sub>	5,858.92	4,714.58	0.0019	0.0043	0.9323
4C	Grassland	CH <sub>4</sub>	2,807.05	2,861.40	0.0016	0.0036	0.9360
5B	Biological treatment of solid waste	CH <sub>4</sub>	21.89	1,373.84	0.0016	0.0036	0.9395
1A5	Other: liquid fuels	CO <sub>2</sub>	5,293.44	1,567.97	0.0014	0.0032	0.9427
4D	Wetlands	CH <sub>4</sub>	2,313.24	2,382.01	0.0014	0.0031	0.9458
4G	Harvested wood products	CO <sub>2</sub>	-2,096.17	-2,037.46	0.0012	0.0028	0.9485
2B8	Petrochemical and carbon black production	CO <sub>2</sub>	4,751.56	1,529.70	0.0011	0.0025	0.9511
4E	Settlements	CO <sub>2</sub>	5,426.53	3,799.29	0.0011	0.0025	0.9535
3B2	Manure management from Sheep	N <sub>2</sub> O	3,038.90	2,493.71	0.0011	0.0024	0.9559
1A3d	Domestic Navigation: liquid fuels	CO <sub>2</sub>	7,611.13	4,862.02	0.0010	0.0023	0.9582
1A3c	Railways: liquid fuels	CO <sub>2</sub>	1,469.34	1,522.80	0.0009	0.0020	0.9601

IPCC Code	IPCC Category	GHG	Base year emissions (Gg CO <sub>2</sub> e)	Latest reported year (LY) emissions (Gg CO <sub>2</sub> e)	Trend Assessment	Contribution to Trend	Cumulative Total
2F4	Aerosols	HFCs, PFCs, SF <sub>6</sub> and NF <sub>3</sub>	407.71	942.13	0.0009	0.0019	0.9620
5D	Wastewater treatment and discharge	CH <sub>4</sub>	2,365.31	1,959.38	0.0008	0.0019	0.9639
2C6	Zinc production	CO <sub>2</sub>	1,350.65	-	0.0008	0.0019	0.9658
1B1	Coal mining and handling	CO <sub>2</sub>	1,698.56	203.99	0.0008	0.0018	0.9676
1A3b	Road transportation: liquid fuels	CH <sub>4</sub>	1,408.61	82.08	0.0008	0.0017	0.9693
5B	Biological treatment of solid waste	N <sub>2</sub> O	12.36	660.50	0.0008	0.0017	0.9710
1A2	Manufacturing industries and construction: other fuels	CO <sub>2</sub>	70.61	683.27	0.0008	0.0017	0.9727
3G	Liming	CO <sub>2</sub>	1,019.16	1,177.94	0.0008	0.0017	0.9744
1A4	Other sectors: solid fuels	CH <sub>4</sub>	1,440.83	166.31	0.0007	0.0015	0.9760
5D	Wastewater treatment and discharge	N <sub>2</sub> O	796.37	903.51	0.0006	0.0013	0.9772
1A1	Energy industries: solid fuels	N <sub>2</sub> O	939.47	29.27	0.0005	0.0012	0.9784
5C	Incineration and open burning of waste	CO <sub>2</sub>	1,445.17	335.70	0.0005	0.0011	0.9796
2A2	Lime production	CO <sub>2</sub>	1,328.60	1,092.26	0.0005	0.0010	0.9806
2A1	Cement production	CO <sub>2</sub>	7,295.26	4,215.15	0.0005	0.0010	0.9816
3A4	Enteric fermentation from Other livestock	CH <sub>4</sub>	338.26	521.04	0.0004	0.0009	0.9825
2G3	N <sub>2</sub> O from product uses	N <sub>2</sub> O	493.41	593.71	0.0004	0.0009	0.9834
1A2	Manufacturing industries and construction: liquid fuels	CO <sub>2</sub>	27,665.96	14,227.59	0.0004	0.0008	0.9842
2F3	Fire protection	HFCs, PFCs, SF <sub>6</sub> and NF <sub>3</sub>	1.47	293.92	0.0003	0.0008	0.9849

IPCC Code	IPCC Category	GHG	Base year emissions (Gg CO <sub>2</sub> e)	Latest reported year (LY) emissions (Gg CO <sub>2</sub> e)	Trend Assessment	Contribution to Trend	Cumulative Total
1A4	Other sectors: biomass	CH <sub>4</sub>	100.88	335.24	0.0003	0.0007	0.9857
2F2	Foam blowing agents	HFCs, PFCs, SF <sub>6</sub> and NF <sub>3</sub>	167.80	353.92	0.0003	0.0007	0.9864
1A3b	Road transportation: liquid fuels	N <sub>2</sub> O	1,176.81	880.35	0.0003	0.0007	0.9871
1A4	Other sectors: peat	CO <sub>2</sub>	453.50	7.71	0.0003	0.0006	0.9877
2A4	Other process uses of carbonates	CO <sub>2</sub>	1,198.69	423.46	0.0002	0.0005	0.9882
1A1	Energy industries: biomass	N <sub>2</sub> O	0.22	205.14	0.0002	0.0005	0.9887
4D	Wetlands	CO <sub>2</sub>	668.77	550.11	0.0002	0.0005	0.9893
2B1	Ammonia production	CO <sub>2</sub>	1,895.00	1,178.74	0.0002	0.0005	0.9897
2C3	Aluminium production	CO <sub>2</sub>	450.32	57.94	0.0002	0.0005	0.9902
1A3b	Road transportation: gaseous fuels	CO <sub>2</sub>	-	178.51	0.0002	0.0005	0.9907
2C4	Magnesium production	HFCs, PFCs, SF <sub>6</sub> and NF <sub>3</sub>	399.06	40.68	0.0002	0.0004	0.9911
1A3b	Road transportation: biomass	CO <sub>2</sub>	-	166.35	0.0002	0.0004	0.9916
1A1	Energy industries: biomass	CH <sub>4</sub>	0.53	163.29	0.0002	0.0004	0.9920
2C3	Aluminium production	HFCs, PFCs, SF <sub>6</sub> and NF <sub>3</sub>	299.84	4.32	0.0002	0.0004	0.9924
1A1	Energy industries: other fuels	CH <sub>4</sub>	20.77	161.15	0.0002	0.0004	0.9928
4A	Forest land	N <sub>2</sub> O	438.95	377.40	0.0002	0.0004	0.9932
4B	Cropland	CH <sub>4</sub>	332.36	317.96	0.0002	0.0004	0.9935
2A3	Glass production	CO <sub>2</sub>	412.37	340.25	0.0001	0.0003	0.9939

IPCC Code	IPCC Category	GHG	Base year emissions (Gg CO <sub>2</sub> e)	Latest reported year (LY) emissions (Gg CO <sub>2</sub> e)	Trend Assessment	Contribution to Trend	Cumulative Total
2D	Non-energy products from fuels and solvent use	CO <sub>2</sub>	552.81	402.41	0.0001	0.0003	0.9942
3F	Field burning of agricultural residues	CH <sub>4</sub>	209.47	-	0.0001	0.0003	0.9944
1A1	Energy industries: other fuels	N <sub>2</sub> O	5.96	111.67	0.0001	0.0003	0.9947
2G1	Electrical equipment	HFCs, PFCs, SF <sub>6</sub> and NF <sub>3</sub>	828.89	330.09	0.0001	0.0003	0.9950
1A2	Manufacturing industries and construction: biomass	N <sub>2</sub> O	19.38	113.93	0.0001	0.0003	0.9953
2B6	Titanium dioxide production	CO <sub>2</sub>	104.63	155.29	0.0001	0.0003	0.9955
1A4	Other sectors: gaseous fuels	CH <sub>4</sub>	176.56	191.50	0.0001	0.0003	0.9958
3H	Urea application to land	CO <sub>2</sub>	293.75	252.57	0.0001	0.0003	0.9961
1A1	Energy industries: gaseous fuels	N <sub>2</sub> O	232.10	215.74	0.0001	0.0002	0.9963
1A4	Other sectors: solid fuels	N <sub>2</sub> O	218.14	23.16	0.0001	0.0002	0.9965
1A3a	Domestic aviation: liquid fuels	CO <sub>2</sub>	1,869.71	897.03	0.0001	0.0002	0.9968
1A2	Manufacturing industries and construction: biomass	CH <sub>4</sub>	15.36	90.53	0.0001	0.0002	0.9970
2B10	Other Chemical Industry	CH <sub>4</sub>	214.15	30.69	0.0001	0.0002	0.9972
1A3e	Other transportation: liquid fuels	CO <sub>2</sub>	98.14	129.66	0.0001	0.0002	0.9974
3J	Agriculture activities in OTs and CDs	CH <sub>4</sub>	306.10	228.23	0.0001	0.0002	0.9976
3A3	Enteric fermentation from Swine	CH <sub>4</sub>	317.02	223.56	0.0001	0.0001	0.9977
4C	Grassland	N <sub>2</sub> O	134.86	127.67	0.0001	0.0001	0.9979
5C	Incineration and open burning of waste	CH <sub>4</sub>	213.78	59.15	0.0001	0.0001	0.9980

IPCC Code	IPCC Category	GHG	Base year emissions (Gg CO <sub>2</sub> e)	Latest reported year (LY) emissions (Gg CO <sub>2</sub> e)	Trend Assessment	Contribution to Trend	Cumulative Total
4A	Forest land	CH <sub>4</sub>	99.49	104.50	0.0001	0.0001	0.9982
2G4	Other product manufacture and use	N <sub>2</sub> O	40.20	72.46	0.0001	0.0001	0.9983
4E	Settlements	N <sub>2</sub> O	392.31	254.78	0.0001	0.0001	0.9984
1A2	Manufacturing industries and construction: solid fuels	N <sub>2</sub> O	125.66	24.82	0.0000	0.0001	0.9985
1A3c	Railways: solid fuels	CO <sub>2</sub>	-	38.41	0.0000	0.0001	0.9986
1A4	Other sectors: liquid fuels	N <sub>2</sub> O	83.51	81.50	0.0000	0.0001	0.9987
1A4	Other sectors: biomass	N <sub>2</sub> O	12.04	41.07	0.0000	0.0001	0.9988
1A1	Energy industries: solid fuels	CH <sub>4</sub>	56.99	1.90	0.0000	0.0001	0.9989
3F	Field burning of agricultural residues	N <sub>2</sub> O	51.40	-	0.0000	0.0001	0.9990
1A1	Energy industries: gaseous fuels	CH <sub>4</sub>	144.26	98.42	0.0000	0.0001	0.9990
3J	Agriculture activities in OTs and CDs	N <sub>2</sub> O	155.42	103.91	0.0000	0.0001	0.9991
1A2	Manufacturing industries and construction: liquid fuels	N <sub>2</sub> O	102.15	74.24	0.0000	0.0001	0.9991
2G2	SF <sub>6</sub> and PFCs from other product use	HFCs, PFCs, SF <sub>6</sub> and NF <sub>3</sub>	191.54	121.01	0.0000	0.0001	0.9992
1A4	Other sectors: gaseous fuels	N <sub>2</sub> O	33.42	36.25	0.0000	0.0000	0.9992
1A4	Other sectors: peat	CH <sub>4</sub>	35.94	0.61	0.0000	0.0000	0.9993
4E	Settlements	CH <sub>4</sub>	19.03	28.19	0.0000	0.0000	0.9993
2F6	Other product uses as substitutes for ODS	HFCs, PFCs, SF <sub>6</sub> and NF <sub>3</sub>	23.59	30.08	0.0000	0.0000	0.9994
2F5	Solvents	HFCs, PFCs, SF <sub>6</sub> and NF <sub>3</sub>	-	16.35	0.0000	0.0000	0.9994

IPCC Code	IPCC Category	GHG	Base year emissions (Gg CO <sub>2</sub> e)	Latest reported year (LY) emissions (Gg CO <sub>2</sub> e)	Trend Assessment	Contribution to Trend	Cumulative Total
1A2	Manufacturing industries and construction: solid fuels	CH <sub>4</sub>	50.06	10.29	0.0000	0.0000	0.9995
2E1	Integrated circuit or semiconductor	HFCs, PFCs, SF <sub>6</sub> and NF <sub>3</sub>	11.10	19.44	0.0000	0.0000	0.9995
2A4	Other process uses of carbonates	CH <sub>4</sub>	34.84	4.75	0.0000	0.0000	0.9995
2B7	Soda ash production	CO <sub>2</sub>	224.40	131.33	0.0000	0.0000	0.9996
4B	Cropland	N <sub>2</sub> O	653.25	354.68	0.0000	0.0000	0.9996
1A1	Energy industries: liquid fuels	CH <sub>4</sub>	38.63	8.73	0.0000	0.0000	0.9996
4D	Wetlands	N <sub>2</sub> O	18.90	21.42	0.0000	0.0000	0.9997
1A5	Other: liquid fuels	N <sub>2</sub> O	49.91	15.03	0.0000	0.0000	0.9997
1B2	Oil and gas extraction	CO <sub>2</sub>	5,088.53	2,682.64	0.0000	0.0000	0.9997
2C1	Iron and steel production	CH <sub>4</sub>	43.92	12.93	0.0000	0.0000	0.9997
4	Indirect N <sub>2</sub> O emissions from LULUCF	N <sub>2</sub> O	271.94	152.89	0.0000	0.0000	0.9998
1A2	Manufacturing industries and construction: other fuels	N <sub>2</sub> O	0.30	9.18	0.0000	0.0000	0.9998
1A1	Energy industries: liquid fuels	N <sub>2</sub> O	99.98	44.07	0.0000	0.0000	0.9998
2B8	Petrochemical and carbon black production	CH <sub>4</sub>	33.79	9.90	0.0000	0.0000	0.9998
1A3d	Domestic Navigation: liquid fuels	N <sub>2</sub> O	93.38	56.78	0.0000	0.0000	0.9999
1A4	Other sectors: liquid fuels	CH <sub>4</sub>	73.07	31.09	0.0000	0.0000	0.9999
1A2	Manufacturing industries and construction: other fuels	CH <sub>4</sub>	0.17	7.04	0.0000	0.0000	0.9999
1A3d	Domestic Navigation: liquid fuels	CH <sub>4</sub>	4.10	7.39	0.0000	0.0000	0.9999

IPCC Code	IPCC Category	GHG	Base year emissions (Gg CO <sub>2</sub> e)	Latest reported year (LY) emissions (Gg CO <sub>2</sub> e)	Trend Assessment	Contribution to Trend	Cumulative Total
1A2	Manufacturing industries and construction: gaseous fuels	CH <sub>4</sub>	13.69	12.40	0.0000	0.0000	0.9999
1A2	Manufacturing industries and construction: gaseous fuels	N <sub>2</sub> O	12.95	11.73	0.0000	0.0000	0.9999
1A3b	Road transportation: gaseous fuels	CH <sub>4</sub>	-	4.73	0.0000	0.0000	0.9999
1A2	Manufacturing industries and construction: liquid fuels	CH <sub>4</sub>	35.43	14.75	0.0000	0.0000	1.0000
2C1	Iron and steel production	N <sub>2</sub> O	18.43	6.54	0.0000	0.0000	1.0000
5C	Incineration and open burning of waste	N <sub>2</sub> O	61.44	35.35	0.0000	0.0000	1.0000
1A3a	Domestic aviation: liquid fuels	CH <sub>4</sub>	7.69	1.18	0.0000	0.0000	1.0000
1A3c	Railways: liquid fuels	N <sub>2</sub> O	2.93	3.04	0.0000	0.0000	1.0000
1B2	Oil and gas extraction	N <sub>2</sub> O	39.74	22.21	0.0000	0.0000	1.0000
1A5	Other: liquid fuels	CH <sub>4</sub>	3.98	1.10	0.0000	0.0000	1.0000
1A3c	Railways: solid fuels	CH <sub>4</sub>	-	0.98	0.0000	0.0000	1.0000
1A3e	Other transportation: liquid fuels	N <sub>2</sub> O	1.05	1.47	0.0000	0.0000	1.0000
1A3c	Railways: liquid fuels	CH <sub>4</sub>	2.75	0.54	0.0000	0.0000	1.0000
1A4	Other sectors: peat	N <sub>2</sub> O	1.59	0.03	0.0000	0.0000	1.0000
1A3a	Domestic aviation: liquid fuels	N <sub>2</sub> O	15.74	7.55	0.0000	0.0000	1.0000
2B8	Petrochemical and carbon black production	N <sub>2</sub> O	1.96	0.74	0.0000	0.0000	1.0000
1A3b	Road transportation: gaseous fuels	N <sub>2</sub> O	-	0.08	0.0000	0.0000	1.0000
2B1	Ammonia production	CH <sub>4</sub>	0.29	0.23	0.0000	0.0000	1.0000

IPCC Code	IPCC Category	GHG	Base year emissions (Gg CO <sub>2</sub> e)	Latest reported year (LY) emissions (Gg CO <sub>2</sub> e)	Trend Assessment	Contribution to Trend	Cumulative Total
2B1	Ammonia production	N <sub>2</sub> O	0.27	0.22	0.0000	0.0000	1.0000
1A3c	Railways: solid fuels	N <sub>2</sub> O	-	0.07	0.0000	0.0000	1.0000
1A3e	Other transportation: liquid fuels	CH <sub>4</sub>	0.14	0.02	0.0000	0.0000	1.0000
1B1	Coal mining and handling	N <sub>2</sub> O	0.08	0.02	0.0000	0.0000	1.0000
<b>Total</b>			<b>820,103.31</b>	<b>430,653.74</b>	<b>0.4470</b>	<b>1.0000</b>	

**Table A 1.3.6 Approach 1 Key Category Analysis based on trend in emissions (from base year to latest reported year, excluding LULUCF) – UNFCCC scope**

IPCC Code	IPCC Category	GHG	Base year emissions (Gg CO <sub>2</sub> e)	Latest reported year (LY) emissions (Gg CO <sub>2</sub> e)	Trend Assessment	Contribution to Trend	Cumulative Total
1A1	Energy industries: solid fuels	CO <sub>2</sub>	185,488.39	6,414.00	0.1066	0.2482	0.2482
1A1	Energy industries: gaseous fuels	CO <sub>2</sub>	11,939.20	54,199.83	0.0562	0.1307	0.3789
1A3b	Road transportation: liquid fuels	CO <sub>2</sub>	109,173.97	99,276.69	0.0492	0.1144	0.4933
1A4	Other sectors: gaseous fuels	CO <sub>2</sub>	70,371.86	76,850.07	0.0467	0.1088	0.6021
5A	Solid waste disposal	CH <sub>4</sub>	67,633.35	13,777.09	0.0255	0.0593	0.6614
1B1	Coal mining and handling	CH <sub>4</sub>	24,446.08	514.50	0.0144	0.0336	0.6950
1A2	Manufacturing industries and construction: gaseous fuels	CO <sub>2</sub>	27,291.18	24,871.53	0.0124	0.0287	0.7237
1A1	Energy industries: liquid fuels	CO <sub>2</sub>	40,387.53	11,869.05	0.0109	0.0255	0.7492
2B3	Adipic acid production	N <sub>2</sub> O	17,727.08	-	0.0109	0.0254	0.7746



IPCC Code	IPCC Category	GHG	Base year emissions (Gg CO <sub>2</sub> e)	Latest reported year (LY) emissions (Gg CO <sub>2</sub> e)	Trend Assessment	Contribution to Trend	Cumulative Total
2F1	Refrigeration and air conditioning	HFCs, PFCs, SF <sub>6</sub> and NF <sub>3</sub>	201.39	9,161.95	0.0106	0.0247	0.7993
1A4	Other sectors: solid fuels	CO <sub>2</sub>	19,824.90	1,952.53	0.0099	0.0231	0.8224
2B9	Fluorochemical production	HFCs, PFCs, SF <sub>6</sub> and NF <sub>3</sub>	14,911.66	120.85	0.0090	0.0210	0.8434
1A2	Manufacturing industries and construction: solid fuels	CO <sub>2</sub>	20,209.42	3,482.14	0.0084	0.0194	0.8628
3A1	Enteric fermentation from Cattle	CH <sub>4</sub>	21,166.02	18,085.60	0.0082	0.0190	0.8818
1A1	Energy industries: other fuels	CO <sub>2</sub>	244.37	6,559.20	0.0075	0.0175	0.8994
3D	Agricultural soils	N <sub>2</sub> O	13,428.41	10,999.18	0.0046	0.0108	0.9101
1B2	Oil and gas extraction	CH <sub>4</sub>	13,835.90	4,541.72	0.0032	0.0074	0.9176
1A4	Other sectors: liquid fuels	CO <sub>2</sub>	21,465.76	13,868.78	0.0030	0.0071	0.9247
3B1	Manure management from Cattle	CH <sub>4</sub>	4,646.15	4,290.16	0.0022	0.0050	0.9297
2C1	Iron and steel production	CO <sub>2</sub>	23,628.28	10,605.21	0.0021	0.0049	0.9346
2B2	Nitric acid production	N <sub>2</sub> O	3,432.78	28.09	0.0021	0.0048	0.9395
3A2	Enteric fermentation from Sheep	CH <sub>4</sub>	5,858.92	4,714.58	0.0019	0.0045	0.9439
5B	Biological treatment of solid waste	CH <sub>4</sub>	21.89	1,373.84	0.0016	0.0037	0.9476
1A5	Other: liquid fuels	CO <sub>2</sub>	5,293.44	1,567.97	0.0014	0.0033	0.9509
2B8	Petrochemical and carbon black production	CO <sub>2</sub>	4,751.56	1,529.70	0.0011	0.0026	0.9536
3B2	Manure management from Sheep	N <sub>2</sub> O	3,038.90	2,493.71	0.0011	0.0024	0.9560
1A3d	Domestic Navigation: liquid fuels	CO <sub>2</sub>	7,611.13	4,862.02	0.0010	0.0024	0.9584
1A3c	Railways: liquid fuels	CO <sub>2</sub>	1,469.34	1,522.80	0.0009	0.0020	0.9604

IPCC Code	IPCC Category	GHG	Base year emissions (Gg CO <sub>2</sub> e)	Latest reported year (LY) emissions (Gg CO <sub>2</sub> e)	Trend Assessment	Contribution to Trend	Cumulative Total
2F4	Aerosols	HFCs, PFCs, SF <sub>6</sub> and NF <sub>3</sub>	407.71	942.13	0.0009	0.0020	0.9624
5D	Wastewater treatment and discharge	CH <sub>4</sub>	2,365.31	1,959.38	0.0008	0.0020	0.9644
2C6	Zinc production	CO <sub>2</sub>	1,350.65	-	0.0008	0.0019	0.9663
1B1	Coal mining and handling	CO <sub>2</sub>	1,698.56	203.99	0.0008	0.0019	0.9682
1A3b	Road transportation: liquid fuels	CH <sub>4</sub>	1,408.61	82.08	0.0008	0.0018	0.9700
5B	Biological treatment of solid waste	N <sub>2</sub> O	12.36	660.50	0.0008	0.0018	0.9718
1A2	Manufacturing industries and construction: other fuels	CO <sub>2</sub>	70.61	683.27	0.0008	0.0018	0.9735
3G	Liming	CO <sub>2</sub>	1,019.16	1,177.94	0.0008	0.0018	0.9753
1A4	Other sectors: solid fuels	CH <sub>4</sub>	1,440.83	166.31	0.0007	0.0016	0.9769
5D	Wastewater treatment and discharge	N <sub>2</sub> O	796.37	903.51	0.0006	0.0013	0.9782
1A1	Energy industries: solid fuels	N <sub>2</sub> O	939.47	29.27	0.0005	0.0013	0.9795
5C	Incineration and open burning of waste	CO <sub>2</sub>	1,445.17	335.70	0.0005	0.0012	0.9806
2A2	Lime production	CO <sub>2</sub>	1,328.60	1,092.26	0.0005	0.0011	0.9817
2A1	Cement production	CO <sub>2</sub>	7,295.26	4,215.15	0.0005	0.0010	0.9828
3A4	Enteric fermentation from Other livestock	CH <sub>4</sub>	338.26	521.04	0.0004	0.0009	0.9837
2G3	N <sub>2</sub> O from product uses	N <sub>2</sub> O	493.41	593.71	0.0004	0.0009	0.9846
1A2	Manufacturing industries and construction: liquid fuels	CO <sub>2</sub>	27,665.96	14,227.59	0.0004	0.0008	0.9854
2F3	Fire protection	HFCs, PFCs, SF <sub>6</sub> and NF <sub>3</sub>	1.47	293.92	0.0003	0.0008	0.9862

IPCC Code	IPCC Category	GHG	Base year emissions (Gg CO <sub>2</sub> e)	Latest reported year (LY) emissions (Gg CO <sub>2</sub> e)	Trend Assessment	Contribution to Trend	Cumulative Total
1A4	Other sectors: biomass	CH <sub>4</sub>	100.88	335.24	0.0003	0.0008	0.9870
2F2	Foam blowing agents	HFCs, PFCs, SF <sub>6</sub> and NF <sub>3</sub>	167.80	353.92	0.0003	0.0007	0.9877
1A3b	Road transportation: liquid fuels	N <sub>2</sub> O	1,176.81	880.35	0.0003	0.0007	0.9884
1A4	Other sectors: peat	CO <sub>2</sub>	453.50	7.71	0.0003	0.0006	0.9891
2A4	Other process uses of carbonates	CO <sub>2</sub>	1,198.69	423.46	0.0002	0.0006	0.9896
1A1	Energy industries: biomass	N <sub>2</sub> O	0.22	205.14	0.0002	0.0006	0.9902
2B1	Ammonia production	CO <sub>2</sub>	1,895.00	1,178.74	0.0002	0.0005	0.9907
2C3	Aluminium production	CO <sub>2</sub>	450.32	57.94	0.0002	0.0005	0.9912
1A3b	Road transportation: gaseous fuels	CO <sub>2</sub>	-	178.51	0.0002	0.0005	0.9917
2C4	Magnesium production	HFCs, PFCs, SF <sub>6</sub> and NF <sub>3</sub>	399.06	40.68	0.0002	0.0005	0.9921
1A3b	Road transportation: biomass	CO <sub>2</sub>	-	166.35	0.0002	0.0005	0.9926
1A1	Energy industries: biomass	CH <sub>4</sub>	0.53	163.29	0.0002	0.0004	0.9930
2C3	Aluminium production	HFCs, PFCs, SF <sub>6</sub> and NF <sub>3</sub>	299.84	4.32	0.0002	0.0004	0.9934
1A1	Energy industries: other fuels	CH <sub>4</sub>	20.77	161.15	0.0002	0.0004	0.9938
2A3	Glass production	CO <sub>2</sub>	412.37	340.25	0.0001	0.0003	0.9942
2D	Non-energy products from fuels and solvent use	CO <sub>2</sub>	552.81	402.41	0.0001	0.0003	0.9945
3F	Field burning of agricultural residues	CH <sub>4</sub>	209.47	-	0.0001	0.0003	0.9948
1A1	Energy industries: other fuels	N <sub>2</sub> O	5.96	111.67	0.0001	0.0003	0.9951

IPCC Code	IPCC Category	GHG	Base year emissions (Gg CO <sub>2</sub> e)	Latest reported year (LY) emissions (Gg CO <sub>2</sub> e)	Trend Assessment	Contribution to Trend	Cumulative Total
2G1	Electrical equipment	HFCs, PFCs, SF <sub>6</sub> and NF <sub>3</sub>	828.89	330.09	0.0001	0.0003	0.9954
1A2	Manufacturing industries and construction: biomass	N <sub>2</sub> O	19.38	113.93	0.0001	0.0003	0.9957
2B6	Titanium dioxide production	CO <sub>2</sub>	104.63	155.29	0.0001	0.0003	0.9959
1A4	Other sectors: gaseous fuels	CH <sub>4</sub>	176.56	191.50	0.0001	0.0003	0.9962
3H	Urea application to land	CO <sub>2</sub>	293.75	252.57	0.0001	0.0003	0.9965
1A1	Energy industries: gaseous fuels	N <sub>2</sub> O	232.10	215.74	0.0001	0.0003	0.9967
1A4	Other sectors: solid fuels	N <sub>2</sub> O	218.14	23.16	0.0001	0.0002	0.9970
1A3a	Domestic aviation: liquid fuels	CO <sub>2</sub>	1,869.71	897.03	0.0001	0.0002	0.9972
1A2	Manufacturing industries and construction: biomass	CH <sub>4</sub>	15.36	90.53	0.0001	0.0002	0.9974
2B10	Other Chemical Industry	CH <sub>4</sub>	214.15	30.69	0.0001	0.0002	0.9977
1A3e	Other transportation: liquid fuels	CO <sub>2</sub>	98.14	129.66	0.0001	0.0002	0.9979
3J	Agriculture activities in OTs and CDs	CH <sub>4</sub>	306.10	228.23	0.0001	0.0002	0.9981
3A3	Enteric fermentation from Swine	CH <sub>4</sub>	317.02	223.56	0.0001	0.0002	0.9982
5C	Incineration and open burning of waste	CH <sub>4</sub>	213.78	59.15	0.0001	0.0001	0.9984
2G4	Other product manufacture and use	N <sub>2</sub> O	40.20	72.46	0.0001	0.0001	0.9985
1A2	Manufacturing industries and construction: solid fuels	N <sub>2</sub> O	125.66	24.82	0.0000	0.0001	0.9986
1A3c	Railways: solid fuels	CO <sub>2</sub>	-	38.41	0.0000	0.0001	0.9987
1A4	Other sectors: liquid fuels	N <sub>2</sub> O	83.51	81.50	0.0000	0.0001	0.9988

IPCC Code	IPCC Category	GHG	Base year emissions (Gg CO <sub>2</sub> e)	Latest reported year (LY) emissions (Gg CO <sub>2</sub> e)	Trend Assessment	Contribution to Trend	Cumulative Total
1A4	Other sectors: biomass	N <sub>2</sub> O	12.04	41.07	0.0000	0.0001	0.9989
1A1	Energy industries: solid fuels	CH <sub>4</sub>	56.99	1.90	0.0000	0.0001	0.9990
3F	Field burning of agricultural residues	N <sub>2</sub> O	51.40	-	0.0000	0.0001	0.9991
1A1	Energy industries: gaseous fuels	CH <sub>4</sub>	144.26	98.42	0.0000	0.0001	0.9991
3J	Agriculture activities in OTs and CDs	N <sub>2</sub> O	155.42	103.91	0.0000	0.0001	0.9992
1A2	Manufacturing industries and construction: liquid fuels	N <sub>2</sub> O	102.15	74.24	0.0000	0.0001	0.9992
2G2	SF <sub>6</sub> and PFCs from other product use	HFCs, PFCs, SF <sub>6</sub> and NF <sub>3</sub>	191.54	121.01	0.0000	0.0001	0.9993
1A4	Other sectors: gaseous fuels	N <sub>2</sub> O	33.42	36.25	0.0000	0.0001	0.9993
1A4	Other sectors: peat	CH <sub>4</sub>	35.94	0.61	0.0000	0.0000	0.9994
2F6	Other product uses as substitutes for ODS	HFCs, PFCs, SF <sub>6</sub> and NF <sub>3</sub>	23.59	30.08	0.0000	0.0000	0.9994
2F5	Solvents	HFCs, PFCs, SF <sub>6</sub> and NF <sub>3</sub>	-	16.35	0.0000	0.0000	0.9995
1A2	Manufacturing industries and construction: solid fuels	CH <sub>4</sub>	50.06	10.29	0.0000	0.0000	0.9995
2E1	Integrated circuit or semiconductor	HFCs, PFCs, SF <sub>6</sub> and NF <sub>3</sub>	11.10	19.44	0.0000	0.0000	0.9996
2A4	Other process uses of carbonates	CH <sub>4</sub>	34.84	4.75	0.0000	0.0000	0.9996
2B7	Soda ash production	CO <sub>2</sub>	224.40	131.33	0.0000	0.0000	0.9996
1A1	Energy industries: liquid fuels	CH <sub>4</sub>	38.63	8.73	0.0000	0.0000	0.9997
1A5	Other: liquid fuels	N <sub>2</sub> O	49.91	15.03	0.0000	0.0000	0.9997

IPCC Code	IPCC Category	GHG	Base year emissions (Gg CO <sub>2</sub> e)	Latest reported year (LY) emissions (Gg CO <sub>2</sub> e)	Trend Assessment	Contribution to Trend	Cumulative Total
1B2	Oil and gas extraction	CO <sub>2</sub>	5,088.53	2,682.64	0.0000	0.0000	0.9997
2C1	Iron and steel production	CH <sub>4</sub>	43.92	12.93	0.0000	0.0000	0.9998
1A2	Manufacturing industries and construction: other fuels	N <sub>2</sub> O	0.30	9.18	0.0000	0.0000	0.9998
1A1	Energy industries: liquid fuels	N <sub>2</sub> O	99.98	44.07	0.0000	0.0000	0.9998
2B8	Petrochemical and carbon black production	CH <sub>4</sub>	33.79	9.90	0.0000	0.0000	0.9998
1A3d	Domestic Navigation: liquid fuels	N <sub>2</sub> O	93.38	56.78	0.0000	0.0000	0.9998
1A4	Other sectors: liquid fuels	CH <sub>4</sub>	73.07	31.09	0.0000	0.0000	0.9999
1A2	Manufacturing industries and construction: other fuels	CH <sub>4</sub>	0.17	7.04	0.0000	0.0000	0.9999
1A3d	Domestic Navigation: liquid fuels	CH <sub>4</sub>	4.10	7.39	0.0000	0.0000	0.9999
1A2	Manufacturing industries and construction: gaseous fuels	CH <sub>4</sub>	13.69	12.40	0.0000	0.0000	0.9999
1A2	Manufacturing industries and construction: gaseous fuels	N <sub>2</sub> O	12.95	11.73	0.0000	0.0000	0.9999
1A3b	Road transportation: gaseous fuels	CH <sub>4</sub>	-	4.73	0.0000	0.0000	0.9999
1A2	Manufacturing industries and construction: liquid fuels	CH <sub>4</sub>	35.43	14.75	0.0000	0.0000	1.0000
2C1	Iron and steel production	N <sub>2</sub> O	18.43	6.54	0.0000	0.0000	1.0000
5C	Incineration and open burning of waste	N <sub>2</sub> O	61.44	35.35	0.0000	0.0000	1.0000
1A3a	Domestic aviation: liquid fuels	CH <sub>4</sub>	7.69	1.18	0.0000	0.0000	1.0000
1A3c	Railways: liquid fuels	N <sub>2</sub> O	2.93	3.04	0.0000	0.0000	1.0000
1B2	Oil and gas extraction	N <sub>2</sub> O	39.74	22.21	0.0000	0.0000	1.0000

IPCC Code	IPCC Category	GHG	Base year emissions (Gg CO <sub>2</sub> e)	Latest reported year (LY) emissions (Gg CO <sub>2</sub> e)	Trend Assessment	Contribution to Trend	Cumulative Total
1A5	Other: liquid fuels	CH <sub>4</sub>	3.98	1.10	0.0000	0.0000	1.0000
1A3c	Railways: solid fuels	CH <sub>4</sub>	-	0.98	0.0000	0.0000	1.0000
1A3e	Other transportation: liquid fuels	N <sub>2</sub> O	1.05	1.47	0.0000	0.0000	1.0000
1A3c	Railways: liquid fuels	CH <sub>4</sub>	2.75	0.54	0.0000	0.0000	1.0000
1A4	Other sectors: peat	N <sub>2</sub> O	1.59	0.03	0.0000	0.0000	1.0000
1A3a	Domestic aviation: liquid fuels	N <sub>2</sub> O	15.74	7.55	0.0000	0.0000	1.0000
2B8	Petrochemical and carbon black production	N <sub>2</sub> O	1.96	0.74	0.0000	0.0000	1.0000
1A3b	Road transportation: gaseous fuels	N <sub>2</sub> O	-	0.08	0.0000	0.0000	1.0000
2B1	Ammonia production	CH <sub>4</sub>	0.29	0.23	0.0000	0.0000	1.0000
2B1	Ammonia production	N <sub>2</sub> O	0.27	0.22	0.0000	0.0000	1.0000
1A3c	Railways: solid fuels	N <sub>2</sub> O	-	0.07	0.0000	0.0000	1.0000
1A3e	Other transportation: liquid fuels	CH <sub>4</sub>	0.14	0.02	0.0000	0.0000	1.0000
1B1	Coal mining and handling	N <sub>2</sub> O	0.08	0.02	0.0000	0.0000	1.0000
<b>Total</b>			<b>808,950.83</b>	<b>429,489.47</b>	<b>0.4296</b>	<b>1.0000</b>	

## A 1.4 QUANTITATIVE APPROACH 2 KCA FOLLOWING IPCC 2006 GUIDELINES

Following the 2006 IPCC Guidelines, the UK has also completed an Approach 2 KCA for both level and trend, which takes into account uncertainties, using the Approach 1 method for uncertainty estimates. This analysis has been performed using the data shown in **Table A 1.4.1** to **Table A 1.4.4** using the same categorisation and the same estimates of uncertainty.

The results of the level assessment (based on Approach 2) with and without LULUCF for the base year and the latest reported year are shown in **Table A 1.4.1** to **Table A 1.4.4**. The key source categories are highlighted by the shaded cells in the table. The source categories (i.e. rows of the table) were sorted in descending order of magnitude based on the results of the “Level Parameter”, and then the cumulative total was included in the final column of the table. The key source categories are those whose contributions add up to 90% of the sum of the level parameter in the final column after this sorting process, which accounts for 90% of the uncertainty in level.

The results of the trend assessment (based on Approach 2) with and without LULUCF for the base year to the latest reported year, are shown in **Table A 1.4.5** to **Table A 1.4.6**.

The key source categories are highlighted by the shaded cells in the table. The trend parameter was calculated using the absolute value of the result; an absolute function is used since Land Use, Land Use Change and Forestry contains negative sources (sinks) and the absolute function is necessary to produce positive uncertainty contributions for these sinks. The source categories (i.e. rows of the table) were sorted in descending order of magnitude based on the results of the trend parameter, and then the cumulative total was included in the final column of the table. The key source categories are those whose contributions add up to 90% of the sum of the level parameter in the final column after this sorting process, which accounts for 90% of the uncertainty in trend.

Any methodological improvements to the uncertainty analysis are discussed in **ANNEX 2**.

**Table A 1.4.1 Approach 2 Level Assessment for Base year (including LULUCF) with Key Categories Shaded in Grey – UNFCCC scope**

IPCC Code	IPCC Category	Gas	Base year emissions (Gg CO <sub>2</sub> e)	Absolute value of Base year emissions (Gg CO <sub>2</sub> e)	Level Assessment	Cumulative Total
5A	5A Solid Waste Disposal	CH <sub>4</sub>	67633.35	67633.35	0.3161	0.3161
1A	1A Coal	CO <sub>2</sub>	225522.71	225522.71	0.0801	0.3962
1A	1A (Stationary) Oil	CO <sub>2</sub>	94802.30	94802.30	0.0588	0.4551
1B2	1B2 Natural Gas Transmission	CH <sub>4</sub>	11880.19	11880.19	0.0577	0.5127
1B1	1B1 Coal Mining	CH <sub>4</sub>	24445.88	24445.88	0.0475	0.5602



IPCC Code	IPCC Category	Gas	Base year emissions (Gg CO <sub>2</sub> e)	Absolute value of Base year emissions (Gg CO <sub>2</sub> e)	Level Assessment	Cumulative Total
5C	5C Waste Incineration	CO <sub>2</sub>	1445.17	1445.17	0.0344	0.5946
4B	4B Cropland	CO <sub>2</sub>	14230.88	14230.88	0.0275	0.6221
4E	4E Settlements	CO <sub>2</sub>	5426.53	5426.53	0.0236	0.6457
1A	1A Natural Gas	CO <sub>2</sub>	109602.23	109602.23	0.0212	0.6670
3D	3D Agricultural Soils	N <sub>2</sub> O	13428.41	13428.41	0.0212	0.6881
2B	2B Chemical industries	N <sub>2</sub> O	21162.10	21162.10	0.0205	0.7086
4A	4A Forest Land	CO <sub>2</sub>	-13940.16	13940.16	0.0202	0.7288
2C	2C Metal Industries	CO <sub>2</sub>	25429.25	25429.25	0.0169	0.7457
5D	5D Wastewater Handling	N <sub>2</sub> O	796.37	796.37	0.0167	0.7624
1B2	1B2 Offshore Oil& Gas	CH <sub>4</sub>	1955.71	1955.71	0.0166	0.7790
1A3b	1A3b Gasoline/ LPG	CO <sub>2</sub>	75379.45	75379.45	0.0162	0.7952
2B	2B Chemical industry	HFCs	14807.32	14807.32	0.0143	0.8095
1A3d	1A3d Marine fuel	CO <sub>2</sub>	7611.13	7611.13	0.0132	0.8227
1A1 & 1A2 & 1A4 & 1A5	1A1 & 1A2 & 1A4 & 1A5 Other Combustion	N <sub>2</sub> O	1936.80	1936.80	0.0122	0.8349
5D	5D Wastewater Handling	CH <sub>4</sub>	2365.31	2365.31	0.0120	0.8468
4C	4C Grassland	CH <sub>4</sub>	2807.05	2807.05	0.0109	0.8577
2B	2B Chemical industries	CO <sub>2</sub>	6975.59	6975.59	0.0105	0.8681
1A3b	1A3b Gasoline/ LPG	CH <sub>4</sub>	1308.55	1308.55	0.0095	0.8776
3A	3A Enteric Fermentation	CH <sub>4</sub>	27680.22	27680.22	0.0091	0.8867

IPCC Code	IPCC Category	Gas	Base year emissions (Gg CO <sub>2</sub> e)	Absolute value of Base year emissions (Gg CO <sub>2</sub> e)	Level Assessment	Cumulative Total
4D	4D Wetland	CH <sub>4</sub>	2313.24	2313.24	0.0078	0.8945
1A3b	1A3b DERV	CO <sub>2</sub>	33792.87	33792.87	0.0073	0.9018
2G	2G Other Product Manufacture and Use	N <sub>2</sub> O	533.61	533.61	0.0073	0.9091
1A1 & 1A2 & 1A4 & 1A5	1A1 & 1A2 & 1A4 & 1A5 Other Combustion	CH <sub>4</sub>	2207.13	2207.13	0.0070	0.9162
3B	3B Manure Management	N <sub>2</sub> O	3038.90	3038.90	0.0067	0.9228
1A3b	1A3b Gasoline/ LPG	N <sub>2</sub> O	887.83	887.83	0.0064	0.9292
5C	5C Waste Incineration	CH <sub>4</sub>	213.78	213.78	0.0056	0.9348
4E	4E Settlements	N <sub>2</sub> O	392.31	392.31	0.0049	0.9397
4	4 Indirect LULUCF Emissions	N <sub>2</sub> O	271.94	271.94	0.0043	0.9441
1A3b	1A3b DERV	N <sub>2</sub> O	288.98	288.98	0.0036	0.9477
4A	4A Forest land	N <sub>2</sub> O	438.95	438.95	0.0036	0.9513
1A3a	1A3a Aviation Fuel	CO <sub>2</sub>	1869.71	1869.71	0.0035	0.9548
1B2	1B2 Oil & Natural Gas	CO <sub>2</sub>	5088.53	5088.53	0.0031	0.9579
4G	4G Other Activities	CO <sub>2</sub>	-2096.17	2096.17	0.0030	0.9609
3B	3B Manure Management	CH <sub>4</sub>	4646.15	4646.15	0.0030	0.9640
2D	2D Non Energy Products from Fuels and Solvent Use	CO <sub>2</sub>	552.81	552.81	0.0030	0.9670
4B	4B Cropland	CH <sub>4</sub>	332.36	332.36	0.0029	0.9699
2A	2A Mineral Industries	CO <sub>2</sub>	10234.92	10234.92	0.0024	0.9722
4B	4B Cropland	N <sub>2</sub> O	653.25	653.25	0.0022	0.9744

IPCC Code	IPCC Category	Gas	Base year emissions (Gg CO <sub>2</sub> e)	Absolute value of Base year emissions (Gg CO <sub>2</sub> e)	Level Assessment	Cumulative Total
3J	3J OT & CD Agriculture	CH <sub>4</sub>	306.10	306.10	0.0021	0.9765
1A3	1A3 Other diesel	CO <sub>2</sub>	1567.49	1567.49	0.0021	0.9786
3G	3G Liming	CO <sub>2</sub>	1019.16	1019.16	0.0021	0.9807
3H	3H Urea application to agriculture	CO <sub>2</sub>	293.75	293.75	0.0014	0.9821
1A4	1A4 Peat	CO <sub>2</sub>	453.50	453.50	0.0014	0.9835
5C	5C Waste Incineration	N <sub>2</sub> O	61.44	61.44	0.0014	0.9848
4D	4D Wetland	CO <sub>2</sub>	668.77	668.77	0.0013	0.9861
1A3b	1A3b DERV	CH <sub>4</sub>	100.06	100.06	0.0013	0.9874
1B1	1B1 Solid Fuel Transformation	CO <sub>2</sub>	1698.56	1698.56	0.0012	0.9886
4C	4C Grassland	CO <sub>2</sub>	-618.75	618.75	0.0012	0.9898
3J	3J OT & CD Agriculture	N <sub>2</sub> O	155.42	155.42	0.0011	0.9909
1A3d	1A3d Marine fuel	N <sub>2</sub> O	93.38	93.38	0.0011	0.9919
2F	2F Product Uses as Substitutes for ODS	HFCs	801.49	801.49	0.0009	0.9928
4A	4A Forest Land	CH <sub>4</sub>	99.49	99.49	0.0008	0.9937
4C	4C Grassland	N <sub>2</sub> O	134.86	134.86	0.0006	0.9942
2G	2G Other Product Manufacture and Use	PFCs	128.63	128.63	0.0006	0.9948
2C	2C Metal Industries	PFCs	299.84	299.84	0.0006	0.9954
3F	3F Field Burning	CH <sub>4</sub>	209.47	209.47	0.0005	0.9959
2B	2B Chemical Industry	CH <sub>4</sub>	248.23	248.23	0.0005	0.9964
2G	2G Other Product Manufacture and Use	SF <sub>6</sub>	891.81	891.81	0.0005	0.9969

IPCC Code	IPCC Category	Gas	Base year emissions (Gg CO <sub>2</sub> e)	Absolute value of Base year emissions (Gg CO <sub>2</sub> e)	Level Assessment	Cumulative Total
1B2	1B2 Oil & Natural Gas	N <sub>2</sub> O	39.74	39.74	0.0004	0.9973
2A	2A Mineral Industries	CH <sub>4</sub>	34.84	34.84	0.0003	0.9976
1A	1A Other (waste)	CO <sub>2</sub>	245.37	245.37	0.0003	0.9979
2C	2C Metal Industries	SF <sub>6</sub>	399.06	399.06	0.0003	0.9982
5B	5B Biological treatment of solid waste	CH <sub>4</sub>	21.89	21.89	0.0002	0.9984
2C	2C Iron & Steel	N <sub>2</sub> O	18.43	18.43	0.0002	0.9986
1A4	1A4 Petroleum Coke	CO <sub>2</sub>	81.64	81.64	0.0002	0.9988
2C	2C Iron & Steel Production	CH <sub>4</sub>	43.92	43.92	0.0002	0.9990
4D	4D Wetland	N <sub>2</sub> O	18.90	18.90	0.0002	0.9992
1A3a	1A3a Aviation Fuel	N <sub>2</sub> O	15.74	15.74	0.0002	0.9993
3F	3F Field Burning	N <sub>2</sub> O	51.40	51.40	0.0001	0.9995
5B	5B Biological treatment of solid waste	N <sub>2</sub> O	12.36	12.36	0.0001	0.9996
2B	2B Chemical industry	PFCs	104.34	104.34	0.0001	0.9997
4E	4E Settlements	CH <sub>4</sub>	19.03	19.03	0.0001	0.9998
1A3d	1A3d Marine fuel	CH <sub>4</sub>	4.10	4.10	0.0001	0.9998
1A3	1A3 Other diesel	N <sub>2</sub> O	3.98	3.98	0.0001	0.9999
2E	2E Electronics Industry	HFCs	10.84	10.84	0.0000	0.9999
1A3a	1A3a Aviation Fuel	CH <sub>4</sub>	7.69	7.69	0.0000	1.0000
1A3	1A3 Other diesel	CH <sub>4</sub>	2.88	2.88	0.0000	1.0000
2E	2E Electronics Industry	NF <sub>3</sub>	0.26	0.26	0.0000	1.0000

IPCC Code	IPCC Category	Gas	Base year emissions (Gg CO <sub>2</sub> e)	Absolute value of Base year emissions (Gg CO <sub>2</sub> e)	Level Assessment	Cumulative Total
2F	2F Product Uses as Substitutes for ODS	PFCs	0.46	0.46	0.0000	1.0000
1B1	1B1 Solid Fuel Transformation	CH <sub>4</sub>	0.20	0.20	0.0000	1.0000
1B1	1B1 Fugitive Emissions from Solid Fuels	N <sub>2</sub> O	0.08	0.08	0.0000	1.0000
1A3	1A3 Natural Gas	CO <sub>2</sub>	0.00	0.00	0.0000	1.0000
1A3c	1A3c Coal	CO <sub>2</sub>	0.00	0.00	0.0000	1.0000
1B2	1B2 Other Energy Industries	CO <sub>2</sub>	0.00	0.00	0.0000	1.0000
4F	4F Other Land	CO <sub>2</sub>	0.00	0.00	0.0000	1.0000
1A3	1A3 Natural Gas	CH <sub>4</sub>	0.00	0.00	0.0000	1.0000
1A3c	1A3c Coal	CH <sub>4</sub>	0.00	0.00	0.0000	1.0000
2D	2D Non-energy Products from Fuels and Solvent Use	CH <sub>4</sub>	0.00	0.00	0.0000	1.0000
1A3	1A3 Natural Gas	N <sub>2</sub> O	0.00	0.00	0.0000	1.0000
1A3c	1A3c Coal	N <sub>2</sub> O	0.00	0.00	0.0000	1.0000
2D	2D Non-energy Products from Fuels and Solvent Use	N <sub>2</sub> O	0.00	0.00	0.0000	1.0000
2C	2C Metal Industries	HFCs	0.00	0.00	0.0000	1.0000
<b>Total</b>			<b>820,103.31</b>	<b>853,413.47</b>	<b>1</b>	

**Table A 1.4.2 Approach 2 Level Assessment for the latest reported year (including LULUCF) with Key Categories Shaded in Grey – UNFCCC scope**

IPCC Code	IPCC Category	Gas	Latest reported year (LY) emissions (Gg CO <sub>2</sub> e)	Absolute value of LY emissions (Gg CO <sub>2</sub> e)	Level Assessment	Cumulative Total
5A	5A Solid Waste Disposal	CH <sub>4</sub>	13777.09	13777.09	0.1381	0.1381
1A	1A Natural Gas	CO <sub>2</sub>	155921.42	155921.42	0.0647	0.2028
4A	4A Forest Land	CO <sub>2</sub>	-18082.25	18082.25	0.0563	0.2591
1A	1A (Stationary) Oil	CO <sub>2</sub>	41428.77	41428.77	0.0551	0.3143
4B	4B Cropland	CO <sub>2</sub>	12690.21	12690.21	0.0526	0.3669
5D	5D Wastewater Handling	N <sub>2</sub> O	903.51	903.51	0.0406	0.4075
1B2	1B2 Natural Gas Transmission	CH <sub>4</sub>	3711.37	3711.37	0.0386	0.4462
3D	3D Agricultural Soils	N <sub>2</sub> O	10999.18	10999.18	0.0372	0.4834
4E	4E Settlements	CO <sub>2</sub>	3799.29	3799.29	0.0354	0.5188
1A3b	1A3b DERV	CO <sub>2</sub>	68500.76	68500.76	0.0317	0.5505
5B	5B Biological treatment of solid waste	CH <sub>4</sub>	1373.84	1373.84	0.0296	0.5801
2F	2F Product Uses as Substitutes for ODS	HFCs	10798.35	10798.35	0.0270	0.6071
4C	4C Grassland	CH <sub>4</sub>	2861.40	2861.40	0.0237	0.6308
1A3b	1A3b DERV	N <sub>2</sub> O	805.91	805.91	0.0217	0.6525
5D	5D Wastewater Handling	CH <sub>4</sub>	1959.38	1959.38	0.0213	0.6738
1A	1A Other (waste)	CO <sub>2</sub>	7042.63	7042.63	0.0205	0.6943
2G	2G Other Product Manufacture and Use	N <sub>2</sub> O	666.17	666.17	0.0195	0.7138
1A3d	1A3d Marine fuel	CO <sub>2</sub>	4862.02	4862.02	0.0181	0.7319

IPCC Code	IPCC Category	Gas	Latest reported year (LY) emissions (Gg CO <sub>2</sub> e)	Absolute value of LY emissions (Gg CO <sub>2</sub> e)	Level Assessment	Cumulative Total
4D	4D Wetland	CH <sub>4</sub>	2382.01	2382.01	0.0173	0.7492
5C	5C Waste Incineration	CO <sub>2</sub>	335.70	335.70	0.0171	0.7663
3A	3A Enteric Fermentation	CH <sub>4</sub>	23544.77	23544.77	0.0166	0.7829
2C	2C Metal Industries	CO <sub>2</sub>	10663.15	10663.15	0.0152	0.7981
1B2	1B2 Offshore Oil& Gas	CH <sub>4</sub>	830.35	830.35	0.0151	0.8132
1A3b	1A3b Gasoline/ LPG	CO <sub>2</sub>	30775.54	30775.54	0.0142	0.8273
1A1 & 1A2 & 1A4 & 1A5	1A1 & 1A2 & 1A4 & 1A5 Other Combustion	N <sub>2</sub> O	1036.85	1036.85	0.0140	0.8413
5B	5B Biological treatment of solid waste	N <sub>2</sub> O	660.50	660.50	0.0130	0.8543
3B	3B Manure Management	N <sub>2</sub> O	2493.71	2493.71	0.0117	0.8660
4C	4C Grassland	CO <sub>2</sub>	-2738.53	2738.53	0.0114	0.8774
2B	2B Chemical industries	CO <sub>2</sub>	2995.07	2995.07	0.0096	0.8870
1A	1A Coal	CO <sub>2</sub>	11848.67	11848.67	0.0090	0.8960
1A1 & 1A2 & 1A4 & 1A5	1A1 & 1A2 & 1A4 & 1A5 Other Combustion	CH <sub>4</sub>	1294.38	1294.38	0.0089	0.9049
4E	4E Settlements	N <sub>2</sub> O	254.78	254.78	0.0069	0.9117
4A	4A Forest land	N <sub>2</sub> O	377.40	377.40	0.0066	0.9184
4G	4G Other Activities	CO <sub>2</sub>	-2037.46	2037.46	0.0063	0.9247
3B	3B Manure Management	CH <sub>4</sub>	4290.16	4290.16	0.0060	0.9307
4B	4B Cropland	CH <sub>4</sub>	317.96	317.96	0.0059	0.9367

IPCC Code	IPCC Category	Gas	Latest reported year (LY) emissions (Gg CO <sub>2</sub> e)	Absolute value of LY emissions (Gg CO <sub>2</sub> e)	Level Assessment	Cumulative Total
4	4 Indirect LULUCF Emissions	N <sub>2</sub> O	152.89	152.89	0.0052	0.9419
1A3	1A3 Other diesel	CO <sub>2</sub>	1818.80	1818.80	0.0052	0.9471
3G	3G Liming	CO <sub>2</sub>	1177.94	1177.94	0.0051	0.9522
2D	2D Non Energy Products from Fuels and Solvent Use	CO <sub>2</sub>	402.41	402.41	0.0047	0.9569
1A3a	1A3a Aviation Fuel	CO <sub>2</sub>	897.03	897.03	0.0036	0.9605
1B2	1B2 Oil & Natural Gas	CO <sub>2</sub>	2658.99	2658.99	0.0035	0.9639
3J	3J OT & CD Agriculture	CH <sub>4</sub>	228.23	228.23	0.0033	0.9673
5C	5C Waste Incineration	CH <sub>4</sub>	59.15	59.15	0.0033	0.9706
2A	2A Mineral Industries	CO <sub>2</sub>	6071.12	6071.12	0.0030	0.9736
3H	3H Urea application to agriculture	CO <sub>2</sub>	252.57	252.57	0.0026	0.9762
4B	4B Cropland	N <sub>2</sub> O	354.68	354.68	0.0026	0.9788
4D	4D Wetland	CO <sub>2</sub>	550.11	550.11	0.0023	0.9811
1B1	1B1 Coal Mining	CH <sub>4</sub>	510.23	510.23	0.0021	0.9832
4A	4A Forest Land	CH <sub>4</sub>	104.50	104.50	0.0018	0.9850
5C	5C Waste Incineration	N <sub>2</sub> O	35.35	35.35	0.0017	0.9867
1A4	1A4 Petroleum Coke	CO <sub>2</sub>	304.86	304.86	0.0016	0.9883
3J	3J OT & CD Agriculture	N <sub>2</sub> O	103.91	103.91	0.0015	0.9898
1A3d	1A3d Marine fuel	N <sub>2</sub> O	56.78	56.78	0.0014	0.9912
4C	4C Grassland	N <sub>2</sub> O	127.67	127.67	0.0012	0.9924
1A3b	1A3b Gasoline/ LPG	CH <sub>4</sub>	75.05	75.05	0.0012	0.9936



IPCC Code	IPCC Category	Gas	Latest reported year (LY) emissions (Gg CO <sub>2</sub> e)	Absolute value of LY emissions (Gg CO <sub>2</sub> e)	Level Assessment	Cumulative Total
1A3b	1A3b Gasoline/ LPG	N <sub>2</sub> O	74.45	74.45	0.0012	0.9947
2G	2G Other Product Manufacture and Use	PFCs	67.70	67.70	0.0007	0.9954
1B2	1B2 Oil & Natural Gas	N <sub>2</sub> O	22.21	22.21	0.0005	0.9958
2G	2G Other Product Manufacture and Use	SF <sub>6</sub>	383.40	383.40	0.0004	0.9963
4D	4D Wetland	N <sub>2</sub> O	21.42	21.42	0.0004	0.9967
1B2	1B2 Other Energy Industries	CO <sub>2</sub>	23.65	23.65	0.0003	0.9970
1B1	1B1 Solid Fuel Transformation	CO <sub>2</sub>	203.99	203.99	0.0003	0.9973
2B	2B Chemical industry	PFCs	120.85	120.85	0.0003	0.9976
4E	4E Settlements	CH <sub>4</sub>	28.19	28.19	0.0002	0.9978
1A3	1A3 Natural Gas	CO <sub>2</sub>	178.51	178.51	0.0002	0.9980
1A3d	1A3d Marine fuel	CH <sub>4</sub>	7.39	7.39	0.0002	0.9982
1A3b	1A3b DERV	CH <sub>4</sub>	7.04	7.04	0.0002	0.9984
2E	2E Electronics Industry	HFCs	19.10	19.10	0.0002	0.9986
2B	2B Chemical Industry	CH <sub>4</sub>	40.83	40.83	0.0002	0.9987
1A3a	1A3a Aviation Fuel	N <sub>2</sub> O	7.55	7.55	0.0002	0.9989
1A3c	1A3c Coal	CO <sub>2</sub>	38.41	38.41	0.0002	0.9991
2C	2C Iron & Steel	N <sub>2</sub> O	6.54	6.54	0.0002	0.9992
1A3	1A3 Natural Gas	CH <sub>4</sub>	4.73	4.73	0.0001	0.9994
1A3	1A3 Other diesel	N <sub>2</sub> O	4.51	4.51	0.0001	0.9995
2C	2C Iron & Steel Production	CH <sub>4</sub>	12.93	12.93	0.0001	0.9996

IPCC Code	IPCC Category	Gas	Latest reported year (LY) emissions (Gg CO <sub>2</sub> e)	Absolute value of LY emissions (Gg CO <sub>2</sub> e)	Level Assessment	Cumulative Total
2A	2A Mineral Industries	CH <sub>4</sub>	4.75	4.75	0.0001	0.9997
2B	2B Chemical industries	N <sub>2</sub> O	29.05	29.05	0.0001	0.9998
2C	2C Metal Industries	SF <sub>6</sub>	38.42	38.42	0.0001	0.9998
1A4	1A4 Peat	CO <sub>2</sub>	7.71	7.71	0.0001	0.9999
1B1	1B1 Solid Fuel Transformation	CH <sub>4</sub>	4.27	4.27	0.0000	0.9999
1A3c	1A3c Coal	CH <sub>4</sub>	0.98	0.98	0.0000	0.9999
2C	2C Metal Industries	PFCs	4.32	4.32	0.0000	1.0000
1A3	1A3 Other diesel	CH <sub>4</sub>	0.57	0.57	0.0000	1.0000
1A3a	1A3a Aviation Fuel	CH <sub>4</sub>	1.18	1.18	0.0000	1.0000
2C	2C Metal Industries	HFCs	2.26	2.26	0.0000	1.0000
2E	2E Electronics Industry	NF <sub>3</sub>	0.34	0.34	0.0000	1.0000
1A3	1A3 Natural Gas	N <sub>2</sub> O	0.08	0.08	0.0000	1.0000
1A3c	1A3c Coal	N <sub>2</sub> O	0.07	0.07	0.0000	1.0000
1B1	1B1 Fugitive Emissions from Solid Fuels	N <sub>2</sub> O	0.02	0.02	0.0000	1.0000
4F	4F Other Land	CO <sub>2</sub>	0.00	0.00	0.0000	1.0000
2D	2D Non-energy Products from Fuels and Solvent Use	CH <sub>4</sub>	0.00	0.00	0.0000	1.0000
3F	3F Field Burning	CH <sub>4</sub>	0.00	0.00	0.0000	1.0000
2D	2D Non-energy Products from Fuels and Solvent Use	N <sub>2</sub> O	0.00	0.00	0.0000	1.0000
3F	3F Field Burning	N <sub>2</sub> O	0.00	0.00	0.0000	1.0000
2B	2B Chemical industry	HFCs	0.00	0.00	0.0000	1.0000

IPCC Code	IPCC Category	Gas	Latest reported year (LY) emissions (Gg CO <sub>2</sub> e)	Absolute value of LY emissions (Gg CO <sub>2</sub> e)	Level Assessment	Cumulative Total
2F	2F Product Uses as Substitutes for ODS	PFCs	0.00	0.00	0.0000	1.0000
<b>Total</b>			<b>430,653.74</b>	<b>476,370.21</b>	<b>1</b>	

**Table A 1.4.3 Approach 2 Level Assessment for Base year (not including LULUCF) with Key Categories Shaded in Grey – UNFCCC scope**

IPCC Code	IPCC Category	Gas	Base year emissions (Gg CO <sub>2</sub> e)	Absolute value of Base year emissions (Gg CO <sub>2</sub> e)	Level Assessment	Cumulative Total
5A	5A Solid Waste Disposal	CH <sub>4</sub>	67633.35	67633.35	0.3573	0.3573
1A	1A Coal	CO <sub>2</sub>	225522.71	225522.71	0.0905	0.4478
1A	1A (Stationary) Oil	CO <sub>2</sub>	94802.30	94802.30	0.0665	0.5143
1B2	1B2 Natural Gas Transmission	CH <sub>4</sub>	11880.19	11880.19	0.0652	0.5795
1B1	1B1 Coal Mining	CH <sub>4</sub>	24445.88	24445.88	0.0536	0.6331
5C	5C Waste Incineration	CO <sub>2</sub>	1445.17	1445.17	0.0389	0.6720
1A	1A Natural Gas	CO <sub>2</sub>	109602.23	109602.23	0.0240	0.6960
3D	3D Agricultural Soils	N <sub>2</sub> O	13428.41	13428.41	0.0239	0.7199
2B	2B Chemical industries	N <sub>2</sub> O	21162.10	21162.10	0.0231	0.7431
2C	2C Metal Industries	CO <sub>2</sub>	25429.25	25429.25	0.0191	0.7622
5D	5D Wastewater Handling	N <sub>2</sub> O	796.37	796.37	0.0188	0.7810
1B2	1B2 Offshore Oil & Gas	CH <sub>4</sub>	1955.71	1955.71	0.0187	0.7997

IPCC Code	IPCC Category	Gas	Base year emissions (Gg CO <sub>2</sub> e)	Absolute value of Base year emissions (Gg CO <sub>2</sub> e)	Level Assessment	Cumulative Total
1A3b	1A3b Gasoline/ LPG	CO <sub>2</sub>	75379.45	75379.45	0.0183	0.8180
2B	2B Chemical industry	HFCs	14807.32	14807.32	0.0162	0.8342
1A3d	1A3d Marine fuel	CO <sub>2</sub>	7611.13	7611.13	0.0149	0.8491
1A1 & 1A2 & 1A4 & 1A5	1A1 & 1A2 & 1A4 & 1A5 Other Combustion	N <sub>2</sub> O	1936.80	1936.80	0.0138	0.8629
5D	5D Wastewater Handling	CH <sub>4</sub>	2365.31	2365.31	0.0135	0.8764
2B	2B Chemical industries	CO <sub>2</sub>	6975.59	6975.59	0.0118	0.8882
1A3b	1A3b Gasoline/ LPG	CH <sub>4</sub>	1308.55	1308.55	0.0107	0.8989
3A	3A Enteric Fermentation	CH <sub>4</sub>	27680.22	27680.22	0.0103	0.9092
1A3b	1A3b DERV	CO <sub>2</sub>	33792.87	33792.87	0.0082	0.9175
2G	2G Other Product Manufacture and Use	N <sub>2</sub> O	533.61	533.61	0.0082	0.9257
1A1 & 1A2 & 1A4 & 1A5	1A1 & 1A2 & 1A4 & 1A5 Other Combustion	CH <sub>4</sub>	2207.13	2207.13	0.0080	0.9337
3B	3B Manure Management	N <sub>2</sub> O	3038.90	3038.90	0.0075	0.9412
1A3b	1A3b Gasoline/ LPG	N <sub>2</sub> O	887.83	887.83	0.0072	0.9484
5C	5C Waste Incineration	CH <sub>4</sub>	213.78	213.78	0.0063	0.9547
1A3b	1A3b DERV	N <sub>2</sub> O	288.98	288.98	0.0041	0.9588
1A3a	1A3a Aviation Fuel	CO <sub>2</sub>	1869.71	1869.71	0.0040	0.9628
1B2	1B2 Oil & Natural Gas	CO <sub>2</sub>	5088.53	5088.53	0.0035	0.9663
3B	3B Manure Management	CH <sub>4</sub>	4646.15	4646.15	0.0034	0.9697
2D	2D Non Energy Products from Fuels and Solvent Use	CO <sub>2</sub>	552.81	552.81	0.0034	0.9731

IPCC Code	IPCC Category	Gas	Base year emissions (Gg CO <sub>2</sub> e)	Absolute value of Base year emissions (Gg CO <sub>2</sub> e)	Level Assessment	Cumulative Total
2A	2A Mineral Industries	CO <sub>2</sub>	10234.92	10234.92	0.0027	0.9758
3J	3J OT & CD Agriculture	CH <sub>4</sub>	306.10	306.10	0.0024	0.9781
1A3	1A3 Other diesel	CO <sub>2</sub>	1567.49	1567.49	0.0024	0.9805
3G	3G Liming	CO <sub>2</sub>	1019.16	1019.16	0.0023	0.9828
3H	3H Urea application to agriculture	CO <sub>2</sub>	293.75	293.75	0.0016	0.9844
1A4	1A4 Peat	CO <sub>2</sub>	453.50	453.50	0.0016	0.9860
5C	5C Waste Incineration	N <sub>2</sub> O	61.44	61.44	0.0015	0.9875
1A3b	1A3b DERV	CH <sub>4</sub>	100.06	100.06	0.0014	0.9890
1B1	1B1 Solid Fuel Transformation	CO <sub>2</sub>	1698.56	1698.56	0.0014	0.9903
3J	3J OT & CD Agriculture	N <sub>2</sub> O	155.42	155.42	0.0012	0.9915
1A3d	1A3d Marine fuel	N <sub>2</sub> O	93.38	93.38	0.0012	0.9927
2F	2F Product Uses as Substitutes for ODS	HFCs	801.49	801.49	0.0011	0.9938
2G	2G Other Product Manufacture and Use	PFCs	128.63	128.63	0.0007	0.9944
2C	2C Metal Industries	PFCs	299.84	299.84	0.0007	0.9951
3F	3F Field Burning	CH <sub>4</sub>	209.47	209.47	0.0006	0.9957
2B	2B Chemical Industry	CH <sub>4</sub>	248.23	248.23	0.0005	0.9962
2G	2G Other Product Manufacture and Use	SF <sub>6</sub>	891.81	891.81	0.0005	0.9967
1B2	1B2 Oil & Natural Gas	N <sub>2</sub> O	39.74	39.74	0.0004	0.9972
2A	2A Mineral Industries	CH <sub>4</sub>	34.84	34.84	0.0004	0.9976
1A	1A Other (waste)	CO <sub>2</sub>	245.37	245.37	0.0004	0.9979

IPCC Code	IPCC Category	Gas	Base year emissions (Gg CO <sub>2</sub> e)	Absolute value of Base year emissions (Gg CO <sub>2</sub> e)	Level Assessment	Cumulative Total
2C	2C Metal Industries	SF <sub>6</sub>	399.06	399.06	0.0003	0.9982
5B	5B Biological treatment of solid waste	CH <sub>4</sub>	21.89	21.89	0.0002	0.9985
2C	2C Iron & Steel	N <sub>2</sub> O	18.43	18.43	0.0002	0.9987
1A4	1A4 Petroleum Coke	CO <sub>2</sub>	81.64	81.64	0.0002	0.9990
2C	2C Iron & Steel Production	CH <sub>4</sub>	43.92	43.92	0.0002	0.9992
1A3a	1A3a Aviation Fuel	N <sub>2</sub> O	15.74	15.74	0.0002	0.9993
3F	3F Field Burning	N <sub>2</sub> O	51.40	51.40	0.0001	0.9995
5B	5B Biological treatment of solid waste	N <sub>2</sub> O	12.36	12.36	0.0001	0.9996
2B	2B Chemical industry	PFCs	104.34	104.34	0.0001	0.9997
1A3d	1A3d Marine fuel	CH <sub>4</sub>	4.10	4.10	0.0001	0.9998
1A3	1A3 Other diesel	N <sub>2</sub> O	3.98	3.98	0.0001	0.9998
2E	2E Electronics Industry	HFCs	10.84	10.84	0.0001	0.9999
1A3a	1A3a Aviation Fuel	CH <sub>4</sub>	7.69	7.69	0.0001	1.0000
1A3	1A3 Other diesel	CH <sub>4</sub>	2.88	2.88	0.0000	1.0000
2E	2E Electronics Industry	NF <sub>3</sub>	0.26	0.26	0.0000	1.0000
2F	2F Product Uses as Substitutes for ODS	PFCs	0.46	0.46	0.0000	1.0000
1B1	1B1 Solid Fuel Transformation	CH <sub>4</sub>	0.20	0.20	0.0000	1.0000
1B1	1B1 Fugitive Emissions from Solid Fuels	N <sub>2</sub> O	0.08	0.08	0.0000	1.0000
1A3	1A3 Natural Gas	CO <sub>2</sub>	0.00	0.00	0.0000	1.0000
1A3c	1A3c Coal	CO <sub>2</sub>	0.00	0.00	0.0000	1.0000

IPCC Code	IPCC Category	Gas	Base year emissions (Gg CO <sub>2</sub> e)	Absolute value of Base year emissions (Gg CO <sub>2</sub> e)	Level Assessment	Cumulative Total
1B2	1B2 Other Energy Industries	CO <sub>2</sub>	0.00	0.00	0.0000	1.0000
1A3	1A3 Natural Gas	CH <sub>4</sub>	0.00	0.00	0.0000	1.0000
1A3c	1A3c Coal	CH <sub>4</sub>	0.00	0.00	0.0000	1.0000
2D	2D Non-energy Products from Fuels and Solvent Use	CH <sub>4</sub>	0.00	0.00	0.0000	1.0000
1A3	1A3 Natural Gas	N <sub>2</sub> O	0.00	0.00	0.0000	1.0000
1A3c	1A3c Coal	N <sub>2</sub> O	0.00	0.00	0.0000	1.0000
2D	2D Non-energy Products from Fuels and Solvent Use	N <sub>2</sub> O	0.00	0.00	0.0000	1.0000
2C	2C Metal Industries	HFCs	0.00	0.00	0.0000	1.0000
<b>Total</b>			<b>808,950.83</b>	<b>808,950.83</b>	<b>1</b>	

**Table A 1.4.4 Approach 2 Level Assessment for the latest reported year (not including LULUCF) with Key Categories Shaded in Grey – UNFCCC scope**

IPCC Code	IPCC Category	Gas	Latest reported year (LY) emissions (Gg CO <sub>2</sub> e)	Absolute value of LY emissions (Gg CO <sub>2</sub> e)	Level Assessment	Cumulative Total
5A	5A Solid Waste Disposal	CH <sub>4</sub>	13777.09	13777.09	0.1808	0.1808
1A	1A Natural Gas	CO <sub>2</sub>	155921.42	155921.42	0.0848	0.2656
1A	1A (Stationary) Oil	CO <sub>2</sub>	41428.77	41428.77	0.0722	0.3378
5D	5D Wastewater Handling	N <sub>2</sub> O	903.51	903.51	0.0531	0.3909
1B2	1B2 Natural Gas Transmission	CH <sub>4</sub>	3711.37	3711.37	0.0506	0.4415

IPCC Code	IPCC Category	Gas	Latest reported year (LY) emissions (Gg CO <sub>2</sub> e)	Absolute value of LY emissions (Gg CO <sub>2</sub> e)	Level Assessment	Cumulative Total
3D	3D Agricultural Soils	N <sub>2</sub> O	10999.18	10999.18	0.0487	0.4902
1A3b	1A3b DERV	CO <sub>2</sub>	68500.76	68500.76	0.0416	0.5318
5B	5B Biological treatment of solid waste	CH <sub>4</sub>	1373.84	1373.84	0.0387	0.5705
2F	2F Product Uses as Substitutes for ODS	HFCs	10798.35	10798.35	0.0353	0.6059
1A3b	1A3b DERV	N <sub>2</sub> O	805.91	805.91	0.0284	0.6343
5D	5D Wastewater Handling	CH <sub>4</sub>	1959.38	1959.38	0.0278	0.6621
1A	1A Other (waste)	CO <sub>2</sub>	7042.63	7042.63	0.0268	0.6889
2G	2G Other Product Manufacture and Use	N <sub>2</sub> O	666.17	666.17	0.0256	0.7145
1A3d	1A3d Marine fuel	CO <sub>2</sub>	4862.02	4862.02	0.0237	0.7382
5C	5C Waste Incineration	CO <sub>2</sub>	335.70	335.70	0.0224	0.7606
3A	3A Enteric Fermentation	CH <sub>4</sub>	23544.77	23544.77	0.0217	0.7823
2C	2C Metal Industries	CO <sub>2</sub>	10663.15	10663.15	0.0199	0.8022
1B2	1B2 Offshore Oil& Gas	CH <sub>4</sub>	830.35	830.35	0.0198	0.8220
1A3b	1A3b Gasoline/ LPG	CO <sub>2</sub>	30775.54	30775.54	0.0186	0.8406
1A1 & 1A2 & 1A4 & 1A5	1A1 & 1A2 & 1A4 & 1A5 Other Combustion	N <sub>2</sub> O	1036.85	1036.85	0.0183	0.8589
5B	5B Biological treatment of solid waste	N <sub>2</sub> O	660.50	660.50	0.0170	0.8759
3B	3B Manure Management	N <sub>2</sub> O	2493.71	2493.71	0.0153	0.8912
2B	2B Chemical industries	CO <sub>2</sub>	2995.07	2995.07	0.0126	0.9038
1A	1A Coal	CO <sub>2</sub>	11848.67	11848.67	0.0118	0.9156



IPCC Code	IPCC Category	Gas	Latest reported year (LY) emissions (Gg CO <sub>2</sub> e)	Absolute value of LY emissions (Gg CO <sub>2</sub> e)	Level Assessment	Cumulative Total
1A1 & 1A2 & 1A4 & 1A5	1A1 & 1A2 & 1A4 & 1A5 Other Combustion	CH <sub>4</sub>	1294.38	1294.38	0.0116	0.9272
3B	3B Manure Management	CH <sub>4</sub>	4290.16	4290.16	0.0079	0.9351
1A3	1A3 Other diesel	CO <sub>2</sub>	1818.80	1818.80	0.0068	0.9419
3G	3G Liming	CO <sub>2</sub>	1177.94	1177.94	0.0067	0.9485
2D	2D Non Energy Products from Fuels and Solvent Use	CO <sub>2</sub>	402.41	402.41	0.0061	0.9547
1A3a	1A3a Aviation Fuel	CO <sub>2</sub>	897.03	897.03	0.0047	0.9594
1B2	1B2 Oil & Natural Gas	CO <sub>2</sub>	2658.99	2658.99	0.0045	0.9639
3J	3J OT & CD Agriculture	CH <sub>4</sub>	228.23	228.23	0.0044	0.9683
5C	5C Waste Incineration	CH <sub>4</sub>	59.15	59.15	0.0043	0.9726
2A	2A Mineral Industries	CO <sub>2</sub>	6071.12	6071.12	0.0040	0.9766
3H	3H Urea application to agriculture	CO <sub>2</sub>	252.57	252.57	0.0034	0.9800
1B1	1B1 Coal Mining	CH <sub>4</sub>	510.23	510.23	0.0028	0.9828
5C	5C Waste Incineration	N <sub>2</sub> O	35.35	35.35	0.0022	0.9850
1A4	1A4 Petroleum Coke	CO <sub>2</sub>	304.86	304.86	0.0021	0.9871
3J	3J OT & CD Agriculture	N <sub>2</sub> O	103.91	103.91	0.0020	0.9891
1A3d	1A3d Marine fuel	N <sub>2</sub> O	56.78	56.78	0.0018	0.9909
1A3b	1A3b Gasoline/ LPG	CH <sub>4</sub>	75.05	75.05	0.0015	0.9924
1A3b	1A3b Gasoline/ LPG	N <sub>2</sub> O	74.45	74.45	0.0015	0.9939
2G	2G Other Product Manufacture and Use	PFCs	67.70	67.70	0.0009	0.9948

IPCC Code	IPCC Category	Gas	Latest reported year (LY) emissions (Gg CO <sub>2</sub> e)	Absolute value of LY emissions (Gg CO <sub>2</sub> e)	Level Assessment	Cumulative Total
1B2	1B2 Oil & Natural Gas	N <sub>2</sub> O	22.21	22.21	0.0006	0.9954
2G	2G Other Product Manufacture and Use	SF <sub>6</sub>	383.40	383.40	0.0006	0.9959
1B2	1B2 Other Energy Industries	CO <sub>2</sub>	23.65	23.65	0.0005	0.9964
1B1	1B1 Solid Fuel Transformation	CO <sub>2</sub>	203.99	203.99	0.0004	0.9968
2B	2B Chemical industry	PFCs	120.85	120.85	0.0003	0.9971
1A3	1A3 Natural Gas	CO <sub>2</sub>	178.51	178.51	0.0003	0.9974
1A3d	1A3d Marine fuel	CH <sub>4</sub>	7.39	7.39	0.0003	0.9976
1A3b	1A3b DERV	CH <sub>4</sub>	7.04	7.04	0.0002	0.9979
2E	2E Electronics Industry	HFCs	19.10	19.10	0.0002	0.9981
2B	2B Chemical Industry	CH <sub>4</sub>	40.83	40.83	0.0002	0.9984
1A3a	1A3a Aviation Fuel	N <sub>2</sub> O	7.55	7.55	0.0002	0.9986
1A3c	1A3c Coal	CO <sub>2</sub>	38.41	38.41	0.0002	0.9988
2C	2C Iron & Steel	N <sub>2</sub> O	6.54	6.54	0.0002	0.9990
1A3	1A3 Natural Gas	CH <sub>4</sub>	4.73	4.73	0.0002	0.9992
1A3	1A3 Other diesel	N <sub>2</sub> O	4.51	4.51	0.0002	0.9993
2C	2C Iron & Steel Production	CH <sub>4</sub>	12.93	12.93	0.0002	0.9995
2A	2A Mineral Industries	CH <sub>4</sub>	4.75	4.75	0.0001	0.9996
2B	2B Chemical industries	N <sub>2</sub> O	29.05	29.05	0.0001	0.9997
2C	2C Metal Industries	SF <sub>6</sub>	38.42	38.42	0.0001	0.9998
1A4	1A4 Peat	CO <sub>2</sub>	7.71	7.71	0.0001	0.9998

IPCC Code	IPCC Category	Gas	Latest reported year (LY) emissions (Gg CO <sub>2</sub> e)	Absolute value of LY emissions (Gg CO <sub>2</sub> e)	Level Assessment	Cumulative Total
1B1	1B1 Solid Fuel Transformation	CH <sub>4</sub>	4.27	4.27	0.0001	0.9999
1A3c	1A3c Coal	CH <sub>4</sub>	0.98	0.98	0.0000	0.9999
2C	2C Metal Industries	PFCs	4.32	4.32	0.0000	0.9999
1A3	1A3 Other diesel	CH <sub>4</sub>	0.57	0.57	0.0000	1.0000
1A3a	1A3a Aviation Fuel	CH <sub>4</sub>	1.18	1.18	0.0000	1.0000
2C	2C Metal Industries	HFCs	2.26	2.26	0.0000	1.0000
2E	2E Electronics Industry	NF <sub>3</sub>	0.34	0.34	0.0000	1.0000
1A3	1A3 Natural Gas	N <sub>2</sub> O	0.08	0.08	0.0000	1.0000
1A3c	1A3c Coal	N <sub>2</sub> O	0.07	0.07	0.0000	1.0000
1B1	1B1 Fugitive Emissions from Solid Fuels	N <sub>2</sub> O	0.02	0.02	0.0000	1.0000
2D	2D Non-energy Products from Fuels and Solvent Use	CH <sub>4</sub>	0.00	0.00	0.0000	1.0000
3F	3F Field Burning	CH <sub>4</sub>	0.00	0.00	0.0000	1.0000
2D	2D Non-energy Products from Fuels and Solvent Use	N <sub>2</sub> O	0.00	0.00	0.0000	1.0000
3F	3F Field Burning	N <sub>2</sub> O	0.00	0.00	0.0000	1.0000
2B	2B Chemical industry	HFCs	0.00	0.00	0.0000	1.0000
2F	2F Product Uses as Substitutes for ODS	PFCs	0.00	0.00	0.0000	1.0000
<b>Total</b>			<b>429,489.47</b>	<b>429,489.47</b>	<b>1</b>	

Table A 1.4.5 Approach 2 Assessment for Trend (including LULUCF) with Key Categories Shaded in Grey – UNFCCC scope

IPCC Code	IPCC Category	Gas	Base year emissions (Gg CO <sub>2</sub> e)	LY emissions (Gg CO <sub>2</sub> e)	Trend Assessment with Uncertainty	% Contribution to Trend Uncertainty	Cumulative Total
5A	5A Solid Waste Disposal	CH <sub>4</sub>	67633.35	13777.09	0.0123	26.5%	0.2655
1A	1A Coal	CO <sub>2</sub>	225522.71	11848.67	0.0046	9.9%	0.3644
1B1	1B1 Coal Mining	CH <sub>4</sub>	24445.88	510.23	0.0029	6.3%	0.4269
1A	1A Natural Gas	CO <sub>2</sub>	109602.23	155921.42	0.0023	5.0%	0.4767
5B	5B Biological treatment of solid waste	CH <sub>4</sub>	21.89	1373.84	0.0017	3.6%	0.5124
1B2	1B2 Natural Gas Transmission	CH <sub>4</sub>	11880.19	3711.37	0.0015	3.2%	0.5444
2F	2F Product Uses as Substitutes for ODS	HFCs	801.49	10798.35	0.0015	3.2%	0.5760
1A3b	1A3b DERV	CO <sub>2</sub>	33792.87	68500.76	0.0013	2.9%	0.6047
2B	2B Chemical industries	N <sub>2</sub> O	21162.10	29.05	0.0013	2.8%	0.6327
5D	5D Wastewater Handling	N <sub>2</sub> O	796.37	903.51	0.0012	2.7%	0.6592
4B	4B Cropland	CO <sub>2</sub>	14230.88	12690.21	0.0012	2.6%	0.6856
5C	5C Waste Incineration	CO <sub>2</sub>	1445.17	335.70	0.0012	2.6%	0.7119
1A	1A Other (waste)	CO <sub>2</sub>	245.37	7042.63	0.0011	2.4%	0.7364
1A3b	1A3b DERV	N <sub>2</sub> O	288.98	805.91	0.0010	2.1%	0.7579
2B	2B Chemical industry	HFCs	14807.32	0.00	0.0009	2.0%	0.7775
3D	3D Agricultural Soils	N <sub>2</sub> O	13428.41	10999.18	0.0008	1.6%	0.7938
5B	5B Biological treatment of solid waste	N <sub>2</sub> O	12.36	660.50	0.0007	1.6%	0.8094
4C	4C Grassland	CH <sub>4</sub>	2807.05	2861.40	0.0007	1.4%	0.8234

IPCC Code	IPCC Category	Gas	Base year emissions (Gg CO <sub>2</sub> e)	LY emissions (Gg CO <sub>2</sub> e)	Trend Assessment with Uncertainty	% Contribution to Trend Uncertainty	Cumulative Total
2G	2G Other Product Manufacture and Use	N <sub>2</sub> O	533.61	666.17	0.0006	1.4%	0.8372
1A	1A (Stationary) Oil	CO <sub>2</sub>	94802.30	41428.77	0.0006	1.4%	0.8508
1A3b	1A3b Gasoline/ LPG	CH <sub>4</sub>	1308.55	75.05	0.0005	1.2%	0.8623
4E	4E Settlements	CO <sub>2</sub>	5426.53	3799.29	0.0005	1.1%	0.8731
4D	4D Wetland	CH <sub>4</sub>	2313.24	2382.01	0.0005	1.0%	0.8834
5D	5D Wastewater Handling	CH <sub>4</sub>	2365.31	1959.38	0.0004	0.9%	0.8929
4A	4A Forest Land	CO <sub>2</sub>	-13940.16	-18082.25	0.0004	0.9%	0.9023
4C	4C Grassland	CO <sub>2</sub>	-618.75	-2738.53	0.0004	0.9%	0.9116
3A	3A Enteric Fermentation	CH <sub>4</sub>	27680.22	23544.77	0.0004	0.8%	0.9193
1A3b	1A3b Gasoline/ LPG	N <sub>2</sub> O	887.83	74.45	0.0003	0.7%	0.9267
3B	3B Manure Management	N <sub>2</sub> O	3038.90	2493.71	0.0002	0.5%	0.9318
1A3b	1A3b Gasoline/ LPG	CO <sub>2</sub>	75379.45	30775.54	0.0002	0.5%	0.9367
2C	2C Metal Industries	CO <sub>2</sub>	25429.25	10663.15	0.0002	0.5%	0.9414
1B2	1B2 Offshore Oil& Gas	CH <sub>4</sub>	1955.71	830.35	0.0002	0.4%	0.9458
4G	4G Other Activities	CO <sub>2</sub>	-2096.17	-2037.46	0.0002	0.4%	0.9498
1A3d	1A3d Marine fuel	CO <sub>2</sub>	7611.13	4862.02	0.0002	0.4%	0.9537
5C	5C Waste Incineration	CH <sub>4</sub>	213.78	59.15	0.0002	0.4%	0.9573
1A3	1A3 Other diesel	CO <sub>2</sub>	1567.49	1818.80	0.0002	0.3%	0.9608
3G	3G Liming	CO <sub>2</sub>	1019.16	1177.94	0.0002	0.3%	0.9642
4B	4B Cropland	CH <sub>4</sub>	332.36	317.96	0.0002	0.3%	0.9674

IPCC Code	IPCC Category	Gas	Base year emissions (Gg CO <sub>2</sub> e)	LY emissions (Gg CO <sub>2</sub> e)	Trend Assessment with Uncertainty	% Contribution to Trend Uncertainty	Cumulative Total
3B	3B Manure Management	CH <sub>4</sub>	4646.15	4290.16	0.0001	0.3%	0.9706
4A	4A Forest land	N <sub>2</sub> O	438.95	377.40	0.0001	0.3%	0.9737
2B	2B Chemical industries	CO <sub>2</sub>	6975.59	2995.07	0.0001	0.3%	0.9763
1A4	1A4 Peat	CO <sub>2</sub>	453.50	7.71	0.0001	0.2%	0.9782
1A4	1A4 Petroleum Coke	CO <sub>2</sub>	81.64	304.86	0.0001	0.2%	0.9798
4E	4E Settlements	N <sub>2</sub> O	392.31	254.78	0.0001	0.2%	0.9814
2D	2D Non Energy Products from Fuels and Solvent Use	CO <sub>2</sub>	552.81	402.41	0.0001	0.2%	0.9830
1A3b	1A3b DERV	CH <sub>4</sub>	100.06	7.04	0.0001	0.1%	0.9845
1B1	1B1 Solid Fuel Transformation	CO <sub>2</sub>	1698.56	203.99	0.0001	0.1%	0.9858
3H	3H Urea application to agriculture	CO <sub>2</sub>	293.75	252.57	0.0001	0.1%	0.9870
3J	3J OT & CD Agriculture	CH <sub>4</sub>	306.10	228.23	0.0001	0.1%	0.9882
1A1 & 1A2 & 1A4 & 1A5	1A1 & 1A2 & 1A4 & 1A5 Other Combustion	CH <sub>4</sub>	2207.13	1294.38	0.0001	0.1%	0.9894
4A	4A Forest Land	CH <sub>4</sub>	99.49	104.50	0.0001	0.1%	0.9905
4D	4D Wetland	CO <sub>2</sub>	668.77	550.11	0.0000	0.1%	0.9915
2C	2C Metal Industries	PFCs	299.84	4.32	0.0000	0.1%	0.9923
3F	3F Field Burning	CH <sub>4</sub>	209.47	0.00	0.0000	0.1%	0.9930
4C	4C Grassland	N <sub>2</sub> O	134.86	127.67	0.0000	0.1%	0.9936
2B	2B Chemical Industry	CH <sub>4</sub>	248.23	40.83	0.0000	0.0%	0.9941

IPCC Code	IPCC Category	Gas	Base year emissions (Gg CO <sub>2</sub> e)	LY emissions (Gg CO <sub>2</sub> e)	Trend Assessment with Uncertainty	% Contribution to Trend Uncertainty	Cumulative Total
2A	2A Mineral Industries	CO <sub>2</sub>	10234.92	6071.12	0.0000	0.0%	0.9945
1B2	1B2 Other Energy Industries	CO <sub>2</sub>	0.00	23.65	0.0000	0.0%	0.9949
4	4 Indirect LULUCF Emissions	N <sub>2</sub> O	271.94	152.89	0.0000	0.0%	0.9953
1A3a	1A3a Aviation Fuel	CO <sub>2</sub>	1869.71	897.03	0.0000	0.0%	0.9958
3J	3J OT & CD Agriculture	N <sub>2</sub> O	155.42	103.91	0.0000	0.0%	0.9962
2A	2A Mineral Industries	CH <sub>4</sub>	34.84	4.75	0.0000	0.0%	0.9965
1A1 & 1A2 & 1A4 & 1A5	1A1 & 1A2 & 1A4 & 1A5 Other Combustion	N <sub>2</sub> O	1936.80	1036.85	0.0000	0.0%	0.9968
2C	2C Metal Industries	SF <sub>6</sub>	399.06	38.42	0.0000	0.0%	0.9971
4D	4D Wetland	N <sub>2</sub> O	18.90	21.42	0.0000	0.0%	0.9974
1A3	1A3 Natural Gas	CO <sub>2</sub>	0.00	178.51	0.0000	0.0%	0.9976
1A3d	1A3d Marine fuel	N <sub>2</sub> O	93.38	56.78	0.0000	0.0%	0.9979
1A3c	1A3c Coal	CO <sub>2</sub>	0.00	38.41	0.0000	0.0%	0.9981
4E	4E Settlements	CH <sub>4</sub>	19.03	28.19	0.0000	0.0%	0.9982
5C	5C Waste Incineration	N <sub>2</sub> O	61.44	35.35	0.0000	0.0%	0.9984
3F	3F Field Burning	N <sub>2</sub> O	51.40	0.00	0.0000	0.0%	0.9986
1A3d	1A3d Marine fuel	CH <sub>4</sub>	4.10	7.39	0.0000	0.0%	0.9988
2B	2B Chemical industry	PFCs	104.34	120.85	0.0000	0.0%	0.9989
2E	2E Electronics Industry	HFCs	10.84	19.10	0.0000	0.0%	0.9991
1A3	1A3 Natural Gas	CH <sub>4</sub>	0.00	4.73	0.0000	0.0%	0.9992

IPCC Code	IPCC Category	Gas	Base year emissions (Gg CO <sub>2</sub> e)	LY emissions (Gg CO <sub>2</sub> e)	Trend Assessment with Uncertainty	% Contribution to Trend Uncertainty	Cumulative Total
2G	2G Other Product Manufacture and Use	SF <sub>6</sub>	891.81	383.40	0.0000	0.0%	0.9994
2C	2C Iron & Steel Production	CH <sub>4</sub>	43.92	12.93	0.0000	0.0%	0.9995
4B	4B Cropland	N <sub>2</sub> O	653.25	354.68	0.0000	0.0%	0.9996
2C	2C Iron & Steel	N <sub>2</sub> O	18.43	6.54	0.0000	0.0%	0.9997
1A3	1A3 Other diesel	N <sub>2</sub> O	3.98	4.51	0.0000	0.0%	0.9998
1B1	1B1 Solid Fuel Transformation	CH <sub>4</sub>	0.20	4.27	0.0000	0.0%	0.9998
1A3a	1A3a Aviation Fuel	CH <sub>4</sub>	7.69	1.18	0.0000	0.0%	0.9998
1B2	1B2 Oil & Natural Gas	N <sub>2</sub> O	39.74	22.21	0.0000	0.0%	0.9999
1A3	1A3 Other diesel	CH <sub>4</sub>	2.88	0.57	0.0000	0.0%	0.9999
1A3c	1A3c Coal	CH <sub>4</sub>	0.00	0.98	0.0000	0.0%	0.9999
1B2	1B2 Oil & Natural Gas	CO <sub>2</sub>	5088.53	2658.99	0.0000	0.0%	1.0000
1A3a	1A3a Aviation Fuel	N <sub>2</sub> O	15.74	7.55	0.0000	0.0%	1.0000
2C	2C Metal Industries	HFCs	0.00	2.26	0.0000	0.0%	1.0000
1A3	1A3 Natural Gas	N <sub>2</sub> O	0.00	0.08	0.0000	0.0%	1.0000
2E	2E Electronics Industry	NF <sub>3</sub>	0.26	0.34	0.0000	0.0%	1.0000
1A3c	1A3c Coal	N <sub>2</sub> O	0.00	0.07	0.0000	0.0%	1.0000
2G	2G Other Product Manufacture and Use	PFCs	128.63	67.70	0.0000	0.0%	1.0000
2F	2F Product Uses as Substitutes for ODS	PFCs	0.46	0.00	0.0000	0.0%	1.0000
1B1	1B1 Fugitive Emissions from Solid Fuels	N <sub>2</sub> O	0.08	0.02	0.0000	0.0%	1.0000
4F	4F Other Land	CO <sub>2</sub>	0.00	0.00	0.0000	0.0%	1.0000



IPCC Code	IPCC Category	Gas	Base year emissions (Gg CO <sub>2</sub> e)	LY emissions (Gg CO <sub>2</sub> e)	Trend Assessment with Uncertainty	% Contribution to Trend Uncertainty	Cumulative Total
2D	2D Non-energy Products from Fuels and Solvent Use	CH <sub>4</sub>	0.00	0.00	0.0000	0.0%	1.0000
2D	2D Non-energy Products from Fuels and Solvent Use	N <sub>2</sub> O	0.00	0.00	0.0000	0.0%	1.0000
<b>Total</b>			<b>820,103.31</b>	<b>430,653.74</b>		<b>1</b>	

**Table A 1.4.6 Approach 2 Assessment for Trend (not including LULUCF) with Key Categories Shaded in Grey – UNFCCC scope**

IPCC Code	IPCC Category	Gas	Base year emissions (Gg CO <sub>2</sub> e)	LY emissions (Gg CO <sub>2</sub> e)	Trend Assessment with Uncertainty	% Contribution to Trend Uncertainty	Cumulative Total
5A	5A Solid Waste Disposal	CH <sub>4</sub>	67633.35	13777.09	0.0123	29.4%	0.2936
1A	1A Coal	CO <sub>2</sub>	225522.71	11848.67	0.0046	10.9%	0.4030
1B1	1B1 Coal Mining	CH <sub>4</sub>	24445.88	510.23	0.0029	6.9%	0.4722
1A	1A Natural Gas	CO <sub>2</sub>	109602.23	155921.42	0.0023	5.5%	0.5272
5B	5B Biological treatment of solid waste	CH <sub>4</sub>	21.89	1373.84	0.0017	4.0%	0.5667
1B2	1B2 Natural Gas Transmission	CH <sub>4</sub>	11880.19	3711.37	0.0015	3.5%	0.6022
2F	2F Product Uses as Substitutes for ODS	HFCs	801.49	10798.35	0.0015	3.5%	0.6371
1A3b	1A3b DERV	CO <sub>2</sub>	33792.87	68500.76	0.0013	3.2%	0.6688
2B	2B Chemical industries	N <sub>2</sub> O	21162.10	29.05	0.0013	3.1%	0.6998
5D	5D Wastewater Handling	N <sub>2</sub> O	796.37	903.51	0.0012	2.9%	0.7291
5C	5C Waste Incineration	CO <sub>2</sub>	1445.17	335.70	0.0012	2.9%	0.7583

IPCC Code	IPCC Category	Gas	Base year emissions (Gg CO <sub>2</sub> e)	LY emissions (Gg CO <sub>2</sub> e)	Trend Assessment with Uncertainty	% Contribution to Trend Uncertainty	Cumulative Total
1A	1A Other (waste)	CO <sub>2</sub>	245.37	7042.63	0.0011	2.7%	0.7853
1A3b	1A3b DERV	N <sub>2</sub> O	288.98	805.91	0.0010	2.4%	0.8091
2B	2B Chemical industry	HFCs	14807.32	0.00	0.0009	2.2%	0.8308
3D	3D Agricultural Soils	N <sub>2</sub> O	13428.41	10999.18	0.0008	1.8%	0.8488
5B	5B Biological treatment of solid waste	N <sub>2</sub> O	12.36	660.50	0.0007	1.7%	0.8661
2G	2G Other Product Manufacture and Use	N <sub>2</sub> O	533.61	666.17	0.0006	1.5%	0.8813
1A	1A (Stationary) Oil	CO <sub>2</sub>	94802.30	41428.77	0.0006	1.5%	0.8963
1A3b	1A3b Gasoline/ LPG	CH <sub>4</sub>	1308.55	75.05	0.0005	1.3%	0.9091
5D	5D Wastewater Handling	CH <sub>4</sub>	2365.31	1959.38	0.0004	1.0%	0.9196
3A	3A Enteric Fermentation	CH <sub>4</sub>	27680.22	23544.77	0.0004	0.9%	0.9281
1A3b	1A3b Gasoline/ LPG	N <sub>2</sub> O	887.83	74.45	0.0003	0.8%	0.9363
3B	3B Manure Management	N <sub>2</sub> O	3038.90	2493.71	0.0002	0.6%	0.9420
1A3b	1A3b Gasoline/ LPG	CO <sub>2</sub>	75379.45	30775.54	0.0002	0.5%	0.9475
2C	2C Metal Industries	CO <sub>2</sub>	25429.25	10663.15	0.0002	0.5%	0.9526
1B2	1B2 Offshore Oil& Gas	CH <sub>4</sub>	1955.71	830.35	0.0002	0.5%	0.9574
1A3d	1A3d Marine fuel	CO <sub>2</sub>	7611.13	4862.02	0.0002	0.4%	0.9618
5C	5C Waste Incineration	CH <sub>4</sub>	213.78	59.15	0.0002	0.4%	0.9658
1A3	1A3 Other diesel	CO <sub>2</sub>	1567.49	1818.80	0.0002	0.4%	0.9696
3G	3G Liming	CO <sub>2</sub>	1019.16	1177.94	0.0002	0.4%	0.9734
3B	3B Manure Management	CH <sub>4</sub>	4646.15	4290.16	0.0001	0.3%	0.9768

IPCC Code	IPCC Category	Gas	Base year emissions (Gg CO <sub>2</sub> e)	LY emissions (Gg CO <sub>2</sub> e)	Trend Assessment with Uncertainty	% Contribution to Trend Uncertainty	Cumulative Total
2B	2B Chemical industries	CO <sub>2</sub>	6975.59	2995.07	0.0001	0.3%	0.9797
1A4	1A4 Peat	CO <sub>2</sub>	453.50	7.71	0.0001	0.2%	0.9818
1A4	1A4 Petroleum Coke	CO <sub>2</sub>	81.64	304.86	0.0001	0.2%	0.9836
2D	2D Non Energy Products from Fuels and Solvent Use	CO <sub>2</sub>	552.81	402.41	0.0001	0.2%	0.9854
1A3b	1A3b DERV	CH <sub>4</sub>	100.06	7.04	0.0001	0.2%	0.9870
1B1	1B1 Solid Fuel Transformation	CO <sub>2</sub>	1698.56	203.99	0.0001	0.1%	0.9884
3H	3H Urea application to agriculture	CO <sub>2</sub>	293.75	252.57	0.0001	0.1%	0.9898
3J	3J OT & CD Agriculture	CH <sub>4</sub>	306.10	228.23	0.0001	0.1%	0.9911
1A1 & 1A2 & 1A4 & 1A5	1A1 & 1A2 & 1A4 & 1A5 Other Combustion	CH <sub>4</sub>	2207.13	1294.38	0.0001	0.1%	0.9924
2C	2C Metal Industries	PFCs	299.84	4.32	0.0000	0.1%	0.9932
3F	3F Field Burning	CH <sub>4</sub>	209.47	0.00	0.0000	0.1%	0.9940
2B	2B Chemical Industry	CH <sub>4</sub>	248.23	40.83	0.0000	0.0%	0.9945
2A	2A Mineral Industries	CO <sub>2</sub>	10234.92	6071.12	0.0000	0.0%	0.9950
1B2	1B2 Other Energy Industries	CO <sub>2</sub>	0.00	23.65	0.0000	0.0%	0.9954
1A3a	1A3a Aviation Fuel	CO <sub>2</sub>	1869.71	897.03	0.0000	0.0%	0.9959
3J	3J OT & CD Agriculture	N <sub>2</sub> O	155.42	103.91	0.0000	0.0%	0.9963
2A	2A Mineral Industries	CH <sub>4</sub>	34.84	4.75	0.0000	0.0%	0.9967

IPCC Code	IPCC Category	Gas	Base year emissions (Gg CO <sub>2</sub> e)	LY emissions (Gg CO <sub>2</sub> e)	Trend Assessment with Uncertainty	% Contribution to Trend Uncertainty	Cumulative Total
1A1 & 1A2 & 1A4 & 1A5	1A1 & 1A2 & 1A4 & 1A5 Other Combustion	N <sub>2</sub> O	1936.80	1036.85	0.0000	0.0%	0.9971
2C	2C Metal Industries	SF <sub>6</sub>	399.06	38.42	0.0000	0.0%	0.9974
1A3	1A3 Natural Gas	CO <sub>2</sub>	0.00	178.51	0.0000	0.0%	0.9977
1A3d	1A3d Marine fuel	N <sub>2</sub> O	93.38	56.78	0.0000	0.0%	0.9979
1A3c	1A3c Coal	CO <sub>2</sub>	0.00	38.41	0.0000	0.0%	0.9982
5C	5C Waste Incineration	N <sub>2</sub> O	61.44	35.35	0.0000	0.0%	0.9984
3F	3F Field Burning	N <sub>2</sub> O	51.40	0.00	0.0000	0.0%	0.9986
1A3d	1A3d Marine fuel	CH <sub>4</sub>	4.10	7.39	0.0000	0.0%	0.9987
2B	2B Chemical industry	PFCs	104.34	120.85	0.0000	0.0%	0.9989
2E	2E Electronics Industry	HFCs	10.84	19.10	0.0000	0.0%	0.9991
1A3	1A3 Natural Gas	CH <sub>4</sub>	0.00	4.73	0.0000	0.0%	0.9993
2G	2G Other Product Manufacture and Use	SF <sub>6</sub>	891.81	383.40	0.0000	0.0%	0.9994
2C	2C Iron & Steel Production	CH <sub>4</sub>	43.92	12.93	0.0000	0.0%	0.9995
2C	2C Iron & Steel	N <sub>2</sub> O	18.43	6.54	0.0000	0.0%	0.9996
1A3	1A3 Other diesel	N <sub>2</sub> O	3.98	4.51	0.0000	0.0%	0.9997
1B1	1B1 Solid Fuel Transformation	CH <sub>4</sub>	0.20	4.27	0.0000	0.0%	0.9998
1A3a	1A3a Aviation Fuel	CH <sub>4</sub>	7.69	1.18	0.0000	0.0%	0.9998
1B2	1B2 Oil & Natural Gas	N <sub>2</sub> O	39.74	22.21	0.0000	0.0%	0.9999
1A3	1A3 Other diesel	CH <sub>4</sub>	2.88	0.57	0.0000	0.0%	0.9999

IPCC Code	IPCC Category	Gas	Base year emissions (Gg CO <sub>2</sub> e)	LY emissions (Gg CO <sub>2</sub> e)	Trend Assessment with Uncertainty	% Contribution to Trend Uncertainty	Cumulative Total
1A3c	1A3c Coal	CH <sub>4</sub>	0.00	0.98	0.0000	0.0%	0.9999
1B2	1B2 Oil & Natural Gas	CO <sub>2</sub>	5088.53	2658.99	0.0000	0.0%	1.0000
1A3a	1A3a Aviation Fuel	N <sub>2</sub> O	15.74	7.55	0.0000	0.0%	1.0000
2C	2C Metal Industries	HFCs	0.00	2.26	0.0000	0.0%	1.0000
1A3	1A3 Natural Gas	N <sub>2</sub> O	0.00	0.08	0.0000	0.0%	1.0000
2E	2E Electronics Industry	NF <sub>3</sub>	0.26	0.34	0.0000	0.0%	1.0000
1A3c	1A3c Coal	N <sub>2</sub> O	0.00	0.07	0.0000	0.0%	1.0000
2G	2G Other Product Manufacture and Use	PFCs	128.63	67.70	0.0000	0.0%	1.0000
2F	2F Product Uses as Substitutes for ODS	PFCs	0.46	0.00	0.0000	0.0%	1.0000
1B1	1B1 Fugitive Emissions from Solid Fuels	N <sub>2</sub> O	0.08	0.02	0.0000	0.0%	1.0000
2D	2D Non-energy Products from Fuels and Solvent Use	CH <sub>4</sub>	0.00	0.00	0.0000	0.0%	1.0000
2D	2D Non-energy Products from Fuels and Solvent Use	N <sub>2</sub> O	0.00	0.00	0.0000	0.0%	1.0000
<b>Total</b>			<b>808,950.83</b>	<b>429,489.47</b>		<b>1</b>	

## A 1.5 KEY CATEGORY ANALYSIS (KCA) RANKING SYSTEM

The Key Category Analysis (KCA) ranking system is an additional tool that the UK has developed to aid in the prioritisation of improvement work. The KCA ranking system works by allocating a score based on how high categories rank in the base year and most recent year level assessments and the trend assessment for the approach 1 KCA including LULUCF. For example, if CO<sub>2</sub> from road transport liquid fuel use is the 4<sup>th</sup> highest by the base year level assessment, 3<sup>rd</sup> highest by the most recent year level assessment and has the 5<sup>th</sup> highest trend assessment then it's score

would be  $4+3+5=12$ . The categories are then ranked from lowest score to highest, with scores that are equal resolved by the most recent year level assessment.

The assessments used in this ranking exercise are only those *including* LULUCF, because if the additional *excluding* LULUCF assessments were also used, the LULUCF sectors would only be included in half of the assessments and would therefore give an unrepresentative weighting.

The results of this ranking are presented in **Table A 1.5.1**.

**Table A 1.5.1 KCA Ranking**

KCA rank (KCs only)	IPCC Code	IPCC Category	Greenhouse Gas
1	1A3b	Road transportation: liquid fuels	CO <sub>2</sub>
2	1A4	Other sectors: gaseous fuels	CO <sub>2</sub>
3	1A2	Manufacturing industries and construction: gaseous fuels	CO <sub>2</sub>
4	5A	Solid waste disposal	CH <sub>4</sub>
5	1A1	Energy industries: solid fuels	CO <sub>2</sub>
6	1A1	Energy industries: liquid fuels	CO <sub>2</sub>
7	1A1	Energy industries: gaseous fuels	CO <sub>2</sub>
8	3A1	Enteric fermentation from Cattle	CH <sub>4</sub>
9	1A4	Other sectors: liquid fuels	CO <sub>2</sub>
10	4B	Cropland	CO <sub>2</sub>
11	4A	Forest land	CO <sub>2</sub>
12	2C1	Iron and steel production	CO <sub>2</sub>
13	3D	Agricultural soils	N <sub>2</sub> O
14	1A2	Manufacturing industries and construction: solid fuels	CO <sub>2</sub>

KCA rank (KCs only)	IPCC Code	IPCC Category	Greenhouse Gas
15	1B2	Oil and gas extraction	CH <sub>4</sub>
16	1A4	Other sectors: solid fuels	CO <sub>2</sub>
17	1B1	Coal mining and handling	CH <sub>4</sub>
18	1A2	Manufacturing industries and construction: liquid fuels	CO <sub>2</sub>
19	3A2	Enteric fermentation from Sheep	CH <sub>4</sub>
20	3B1	Manure management from Cattle	CH <sub>4</sub>
21	1A3d	Domestic Navigation: liquid fuels	CO <sub>2</sub>
22	4E	Settlements	CO <sub>2</sub>
23	4C	Grassland	CH <sub>4</sub>
24	1A5	Other: liquid fuels	CO <sub>2</sub>
25	3B2	Manure management from Sheep	N <sub>2</sub> O
26	4D	Wetlands	CH <sub>4</sub>
27	2B8	Petrochemical and carbon black production	CO <sub>2</sub>
28	2A1	Cement production	CO <sub>2</sub>
29	4G	Harvested wood products	CO <sub>2</sub>
30	1A1	Energy industries: other fuels	CO <sub>2</sub>
31	4C	Grassland	CO <sub>2</sub>
32	5D	Wastewater treatment and discharge	CH <sub>4</sub>
33	2F1	Refrigeration and air conditioning	HFCs, PFCs, SF <sub>6</sub> and NF <sub>3</sub>
34	2B9	Fluorochemical production	HFCs, PFCs, SF <sub>6</sub> and NF <sub>3</sub>
35	2B2	Nitric acid production	N <sub>2</sub> O

---

KCA rank (KCs only)	IPCC Code	IPCC Category	Greenhouse Gas
36	2B3	Adipic acid production	N <sub>2</sub> O
37	1B2	Oil and gas extraction	CO <sub>2</sub>
38	5B	Biological treatment of solid waste	CH <sub>4</sub>

## A 1.6 USING THE UNCERTAINTY ANALYSIS TO PLAN IMPROVEMENTS IN THE PREPARATION OF THE INVENTORY

The key category analysis is used to prioritise and plan improvements. The approach the UK takes to achieve this is described in **Section 1.2.2.5**. **Table 1.7** to **Table 1.11** in **Chapter 1** show the key category summary tables.



## ANNEX 2: Assessment of Uncertainty

Uncertainty estimates are calculated using two methods: Approach 1 (error propagation) and Approach 2 (Monte Carlo simulation). These are not to be confused with Approaches 1 and 2 for Key Category Analysis (KCA), of which Approach 2 KCA uses Approach 1 uncertainties to account for uncertainty in determining Key Categories.

Uncertainties have been estimated by IPCC sector and direct greenhouse gas. It may be possible to estimate uncertainty at higher levels of sectoral detail, however this would require further understanding of the dependencies between sub-sectors and greatly increase the complexity of the Approach 2 model. Aggregation has therefore been used as a method to avoid the risk of unaccounted for correlations and retain accuracy in uncertainty estimates, as advised in the 2006 IPCC guidelines (vol. 1, chap. 3, pg. 3.25). Uncertainty estimates for the sector breakdown used in UK Official Statistics are also not reported here, since the categories are not consistent with the requirements of the UK's commitments under the UNFCCC and Kyoto Protocol.

Uncertainty parameters for new sources and sources which have been significantly revised are reviewed each year, particularly for sources which have a significant impact on overall uncertainties. The overall method used to estimate uncertainties is described below, and the work to improve the accuracy of the uncertainty analysis continues. The key category analysis used data from the uncertainty analysis, and the results of the key category analysis are given in **ANNEX 1**.

### A 2.1 ESTIMATION OF UNCERTAINTIES USING AN ERROR PROPAGATION APPROACH (APPROACH 1)

The IPCC 2006 Guidelines defines error propagation and Monte Carlo modelling approaches to estimating uncertainties in national greenhouse gas inventories. The results of the error propagation approach are shown in **Table A 2.1.1**. The uncertainties used in the error propagation approach are not exactly the same as those used in the Monte Carlo Simulation since the error propagation source categorisation is less detailed and has a more simplistic approach to uncertainties. The Approach 1 uncertainties assumes all parameters are normally distributed (which means it doesn't account for the skew, kurtosis or any other non-normal features of the expected distributions), and does not account for variations in uncertainty in the time series unlike the Monte Carlo approach which takes into account these factors. The parameters used for the Approach 1 uncertainties for both the base year and the most recent year are the values given for the most recent year in **Table A 2.3.1** to **Table A 2.3.4**.

#### A 2.1.1 Key Categories

Certain source categories are particularly significant in terms of their contribution to the overall uncertainty of the inventory. Key source categories in this respect are identified using Approach 1 uncertainties in the Approach 2 KCA. These have been identified so that the resources available for inventory preparation may be prioritised, and the best possible estimates prepared for the most significant source categories. We have used the method used for key category analysis is described in Section 4.3.2 of the 2006 IPCC Guidelines Volume 1 General Guidance and

Reporting (Approach 2 to identify key categories)and. The results of this key category analysis can be found in **ANNEX 1**:

#### **A 2.1.1.1 Uncertainty in the Trend**

Trend uncertainties are estimated using two sensitivities. These are described in the 2006 IPCC guidelines as:

- Type A sensitivity: the change in the difference in overall emissions between the base year and the current year, expressed as a percentage, resulting from a 1 percent increase in emissions or removals of a given category and gas in both the base year and the current year.

Type B sensitivity: the change in the difference in overall emissions between the base year and the current year, expressed as a percentage, resulting from a 1 percent increase in emissions or removals of a given category and gas in the current year only.

Conceptually, Type A sensitivity arises from uncertainties that affect emissions or removals in the base year and the current year equally, and Type B sensitivity arises from uncertainties that affect emissions or removals in the current year only. Uncertainties that are fully correlated between years will be associated with Type A sensitivities, and uncertainties that are not correlated between years will be associated with Type B sensitivities. Once the uncertainties introduced into the national inventory by Type A and Type B sensitivities have been calculated, they can be summed using the error propagation equation to give the overall uncertainty in the trend.

### A 2.1.2 Tables of uncertainty estimates from the error propagation approach

Table A 2.1.1 Summary of error propagation uncertainty estimates including LULUCF, base year to the latest reported year<sup>2</sup>

IPCC Category	Gas	Base year emissions (Gg CO <sub>2e</sub> )	2021 emissions (Gg CO <sub>2e</sub> )	Activity data uncertainty (%)	Emission factor uncertainty (%)	Combined uncertainty (%)	Contribution to variance by Category in 2021	Type A sensitivity	Type B sensitivity	Uncertainty in trend in national emissions introduced by emission factor / estimation parameter uncertainty	Uncertainty in trend in national emissions introduced by activity data uncertainty	Uncertainty introduced into the trend in total national emissions
1A (Stationary) Oil	CO <sub>2</sub>	94,802.30	41,428.77	6.08%	2.08%	6.4%	0.0000	1.017%	5.052%	0.0211%	0.4344%	0.0019%
1A Coal	CO <sub>2</sub>	225,522.71	11,848.67	1.78%	3.22%	3.7%	0.0000	12.960%	1.445%	0.4174%	0.0363%	0.0018%
1A Natural Gas	CO <sub>2</sub>	109,602.23	155,921.42	1.06%	1.70%	2.0%	0.0001	11.978%	19.012%	0.2039%	0.2843%	0.0012%
1A Other (waste)	CO <sub>2</sub>	245.37	7,042.63	1.01%	13.99%	14.0%	0.0000	0.843%	0.859%	0.1179%	0.0123%	0.0001%
1A3 Other diesel	CO <sub>2</sub>	1,567.49	1,818.80	13.64%	1.87%	13.8%	0.0000	0.121%	0.222%	0.0023%	0.0428%	0.0000%
1A3 Natural Gas	CO <sub>2</sub>	-	178.51	5.00%	2.00%	5.4%	0.0000	0.022%	0.022%	0.0004%	0.0015%	0.0000%
1A3a Aviation Fuel	CO <sub>2</sub>	1,869.71	897.03	19.23%	3.17%	19.5%	0.0000	0.010%	0.109%	0.0003%	0.0298%	0.0000%
1A3b DERV	CO <sub>2</sub>	33,792.87	68,500.76	1.00%	2.00%	2.2%	0.0000	6.186%	8.353%	0.1237%	0.1181%	0.0003%
1A3b Gasoline/ LPG	CO <sub>2</sub>	75,379.45	30,775.54	0.99%	1.99%	2.2%	0.0000	1.073%	3.753%	0.0213%	0.0528%	0.0000%

<sup>2</sup> Emissions presented are for UNFCCC geographical coverage.

IPCC Category	Gas	Base year emissions (Gg CO <sub>2</sub> e)	2021 emissions (Gg CO <sub>2</sub> e)	Activity data uncertainty (%)	Emission factor uncertainty (%)	Combined uncertainty (%)	Contribution to variance by Category in 2021	Type A sensitivity	Type B sensitivity	Uncertainty in trend in national emissions introduced by emission factor / estimation parameter uncertainty	Uncertainty in trend in national emissions introduced by activity data uncertainty	Uncertainty introduced into the trend in total national emissions
1A3c Coal	CO <sub>2</sub>	-	38.41	20.00%	6.00%	20.9%	0.0000	0.005%	0.005%	0.0003%	0.0013%	0.0000%
1A3d Marine fuel	CO <sub>2</sub>	7,611.13	4,862.02	17.88%	1.79%	18.0%	0.0000	0.105%	0.593%	0.0019%	0.1499%	0.0002%
1A4 Peat	CO <sub>2</sub>	453.50	7.71	30.00%	10.00%	31.6%	0.0000	0.028%	0.001%	0.0028%	0.0004%	0.0000%
1A4 Petroleum Coke	CO <sub>2</sub>	81.64	304.86	20.00%	15.00%	25.0%	0.0000	0.032%	0.037%	0.0048%	0.0105%	0.0000%
1B1 Solid Fuel Transformation	CO <sub>2</sub>	1,698.56	203.99	5.70%	4.66%	7.4%	0.0000	0.084%	0.025%	0.0039%	0.0020%	0.0000%
1B2 Oil & Natural Gas	CO <sub>2</sub>	5,088.53	2,658.99	4.35%	4.52%	6.3%	0.0000	0.002%	0.324%	0.0001%	0.0199%	0.0000%
1B2 Other Energy Industries	CO <sub>2</sub>	-	23.65	50.00%	50.00%	70.7%	0.0000	0.003%	0.003%	0.0014%	0.0020%	0.0000%
2A Mineral Industries	CO <sub>2</sub>	10,234.92	6,071.12	0.71%	2.30%	2.4%	0.0000	0.085%	0.740%	0.0019%	0.0074%	0.0000%
2B Chemical industries	CO <sub>2</sub>	6,975.59	2,995.07	15.28%	2.65%	15.5%	0.0000	0.081%	0.365%	0.0022%	0.0789%	0.0001%
2C Metal Industries	CO <sub>2</sub>	25,429.25	10,663.15	1.36%	6.75%	6.9%	0.0000	0.328%	1.300%	0.0221%	0.0250%	0.0000%

IPCC Category	Gas	Base year emissions (Gg CO <sub>2</sub> e)	2021 emissions (Gg CO <sub>2</sub> e)	Activity data uncertainty (%)	Emission factor uncertainty (%)	Combined uncertainty (%)	Contribution to variance by Category in 2021	Type A sensitivity	Type B sensitivity	Uncertainty in trend in national emissions introduced by emission factor / estimation parameter uncertainty	Uncertainty in trend in national emissions introduced by activity data uncertainty	Uncertainty introduced into the trend in total national emissions
2D Non Energy Products from Fuels and Solvent Use	CO <sub>2</sub>	552.81	402.41	39.83%	39.48%	56.1%	0.0000	0.014%	0.049%	0.0054%	0.0276%	0.0000%
3G Liming	CO <sub>2</sub>	1,019.16414	1,177.94	0.00%	20.90%	20.9%	0.0000	0.078%	0.144%	0.0164%	0.0000%	0.0000%
3H Urea application to agriculture	CO <sub>2</sub>	293.75	252.57	0.00%	50.00%	50.0%	0.0000	0.012%	0.031%	0.0060%	0.0000%	0.0000%
4A Forest Land	CO <sub>2</sub>	-13,940.16	-18,082.25	1.00%	15.00%	15.0%	0.0000	1.312%	2.205%	0.1969%	0.0312%	0.0004%
4B Cropland	CO <sub>2</sub>	14,230.88	12,690.21	1.00%	20.00%	20.0%	0.0000	0.636%	1.547%	0.1272%	0.0219%	0.0002%
4C Grassland	CO <sub>2</sub>	-618.75	-2,738.53	1.00%	20.00%	20.0%	0.0000	0.294%	0.334%	0.0589%	0.0047%	0.0000%
4D Wetland	CO <sub>2</sub>	668.77	550.11	1.00%	20.00%	20.0%	0.0000	0.024%	0.067%	0.0049%	0.0009%	0.0000%
4E Settlements	CO <sub>2</sub>	5,426.53	3,799.29	1.00%	45.00%	45.0%	0.0000	0.116%	0.463%	0.0521%	0.0066%	0.0000%
4F Other Land	CO <sub>2</sub>	-	-	0.00%	0.00%	0.0%	-	0.000%	0.000%	0.0000%	0.0000%	0.0000%
4G Other Activities	CO <sub>2</sub>	-2,096.17	-2,037.46	1.00%	15.00%	15.0%	0.0000	0.114%	0.248%	0.0171%	0.0035%	0.0000%
5C Waste Incineration	CO <sub>2</sub>	1,445.17	335.70	243.62%	37.39%	246.5%	0.0000	0.052%	0.041%	0.0193%	0.1410%	0.0002%

IPCC Category	Gas	Base year emissions (Gg CO <sub>2</sub> e)	2021 emissions (Gg CO <sub>2</sub> e)	Activity data uncertainty (%)	Emission factor uncertainty (%)	Combined uncertainty (%)	Contribution to variance by Category in 2021	Type A sensitivity	Type B sensitivity	Uncertainty in trend in national emissions introduced by emission factor / estimation parameter uncertainty	Uncertainty in trend in national emissions introduced by activity data uncertainty	Uncertainty introduced into the trend in total national emissions
1A1 & 1A2 & 1A4 & 1A5 Other Combustion	CH <sub>4</sub>	2,207.13	1,294.38	0.66%	33.04%	33.0%	0.0000	0.017%	0.158%	0.0055%	0.0015%	0.0000%
1A3 Other diesel	CH <sub>4</sub>	2.88	0.57	15.00%	130.00%	130.9%	0.0000	0.000%	0.000%	0.0002%	0.0000%	0.0000%
1A3 Natural Gas	CH <sub>4</sub>	-	4.73	5.00%	130.00%	130.1%	0.0000	0.001%	0.001%	0.0007%	0.0000%	0.0000%
1A3a Aviation Fuel	CH <sub>4</sub>	7.69	1.18	15.13%	59.37%	61.3%	0.0000	0.000%	0.000%	0.0002%	0.0000%	0.0000%
1A3b DERV	CH <sub>4</sub>	100.06	7.04	1.00%	130.00%	130.0%	0.0000	0.006%	0.001%	0.0072%	0.0000%	0.0000%
1A3b Gasoline/ LPG	CH <sub>4</sub>	1,308.55	75.05	1.00%	74.93%	74.9%	0.0000	0.075%	0.009%	0.0559%	0.0001%	0.0000%
1A3c Coal	CH <sub>4</sub>	-	0.98	20.00%	110.00%	111.8%	0.0000	0.000%	0.000%	0.0001%	0.0000%	0.0000%
1A3d Marine fuel	CH <sub>4</sub>	4.10	7.39	19.33%	125.67%	127.2%	0.0000	0.001%	0.001%	0.0008%	0.0002%	0.0000%
1B1 Coal Mining	CH <sub>4</sub>	24,445.88	510.23	2.00%	20.00%	20.1%	0.0000	1.503%	0.062%	0.3005%	0.0018%	0.0009%
1B1 Solid Fuel Transformation	CH <sub>4</sub>	0.20	4.27	0.00%	49.76%	49.8%	0.0000	0.001%	0.001%	0.0003%	0.0000%	0.0000%
1B2 Natural Gas Transmission	CH <sub>4</sub>	11,880.19	3,711.37	5.00%	50.00%	50.2%	0.0000	0.308%	0.453%	0.1541%	0.0320%	0.0002%

IPCC Category	Gas	Base year emissions (Gg CO <sub>2</sub> e)	2021 emissions (Gg CO <sub>2</sub> e)	Activity data uncertainty (%)	Emission factor uncertainty (%)	Combined uncertainty (%)	Contribution to variance by Category in 2021	Type A sensitivity	Type B sensitivity	Uncertainty in trend in national emissions introduced by emission factor / estimation parameter uncertainty	Uncertainty in trend in national emissions introduced by activity data uncertainty	Uncertainty introduced into the trend in total national emissions
1B2 Upstream Oil & Gas	CH <sub>4</sub>	1,955.71	830.35	4.41%	87.57%	87.7%	0.0000	0.024%	0.101%	0.0210%	0.0063%	0.0000%
2A Mineral Industries	CH <sub>4</sub>	34.84	4.75	0.00%	100.00%	100.0%	0.0000	0.002%	0.001%	0.0017%	0.0000%	0.0000%
2B Chemical Industry	CH <sub>4</sub>	248.23	40.83	0.00%	20.00%	20.0%	0.0000	0.011%	0.005%	0.0022%	0.0000%	0.0000%
2C Iron & Steel Production	CH <sub>4</sub>	43.92	12.93	1.76%	44.22%	44.3%	0.0000	0.001%	0.002%	0.0005%	0.0000%	0.0000%
2D Non-energy Products from Fuels and Solvent Use	CH <sub>4</sub>	-	-	0.00%	0.00%	0.0%	-	0.000%	0.000%	0.0000%	0.0000%	0.0000%
3A Enteric Fermentation	CH <sub>4</sub>	27,680.22	23,544.77	0.00%	3.40%	3.4%	0.0000	1.098%	2.871%	0.0373%	0.0000%	0.0000%
3B Manure Management	CH <sub>4</sub>	4,646.15	4,290.16	0.00%	6.76%	6.8%	0.0000	0.226%	0.523%	0.0152%	0.0000%	0.0000%
3F Field Burning	CH <sub>4</sub>	209.47	-	25.61%	0.00%	25.6%	-	0.013%	0.000%	0.0000%	0.0000%	0.0000%
3J OT & CD Agriculture	CH <sub>4</sub>	306.10	228.23	50.00%	50.00%	70.7%	0.0000	0.008%	0.028%	0.0041%	0.0197%	0.0000%
4A Forest Land	CH <sub>4</sub>	99.49	104.50	1.00%	85.00%	85.0%	0.0000	0.006%	0.013%	0.0054%	0.0002%	0.0000%
4B Cropland	CH <sub>4</sub>	332.36	317.96	1.00%	90.00%	90.0%	0.0000	0.017%	0.039%	0.0157%	0.0005%	0.0000%

IPCC Category	Gas	Base year emissions (Gg CO <sub>2</sub> e)	2021 emissions (Gg CO <sub>2</sub> e)	Activity data uncertainty (%)	Emission factor uncertainty (%)	Combined uncertainty (%)	Contribution to variance by Category in 2021	Type A sensitivity	Type B sensitivity	Uncertainty in trend in national emissions introduced by emission factor / estimation parameter uncertainty	Uncertainty in trend in national emissions introduced by activity data uncertainty	Uncertainty introduced into the trend in total national emissions
4C Grassland	CH <sub>4</sub>	2,807.05	2,861.40	1.00%	40.00%	40.0%	0.0000	0.169%	0.349%	0.0677%	0.0049%	0.0000%
4D Wetland	CH <sub>4</sub>	2,313.24	2,382.01	1.00%	35.00%	35.0%	0.0000	0.142%	0.290%	0.0498%	0.0041%	0.0000%
4E Settlements	CH <sub>4</sub>	19.03	28.19	1.00%	40.00%	40.0%	0.0000	0.002%	0.003%	0.0009%	0.0000%	0.0000%
5A Solid Waste Disposal	CH <sub>4</sub>	67,633.35	13,777.09	15.00%	46.00%	48.4%	0.0002	2.649%	1.680%	1.2183%	0.3564%	0.0161%
5B Biological treatment of solid waste	CH <sub>4</sub>	21.89	1,373.84	30.00%	99.50%	103.9%	0.0000	0.166%	0.168%	0.1653%	0.0711%	0.0003%
5C Waste Incineration	CH <sub>4</sub>	213.78	59.15	256.09%	85.64%	270.0%	0.0000	0.006%	0.007%	0.0055%	0.0261%	0.0000%
5D Wastewater Handling	CH <sub>4</sub>	2,365.31	1,959.38	15.40%	50.08%	52.4%	0.0000	0.087%	0.239%	0.0438%	0.0520%	0.0000%
1A1 & 1A2 & 1A4 & 1A5 Other Combustion	N <sub>2</sub> O	1,936.80	1,036.85	0.66%	65.07%	65.1%	0.0000	0.002%	0.126%	0.0016%	0.0012%	0.0000%
1A3 Other diesel	N <sub>2</sub> O	3.98	4.51	15.00%	130.00%	130.9%	0.0000	0.000%	0.001%	0.0004%	0.0001%	0.0000%
1A3 Natural Gas	N <sub>2</sub> O	-	0.08	5.00%	130.00%	130.1%	0.0000	0.000%	0.000%	0.0000%	0.0000%	0.0000%
1A3a Aviation Fuel	N <sub>2</sub> O	15.74	7.55	19.23%	105.76%	107.5%	0.0000	0.000%	0.001%	0.0001%	0.0003%	0.0000%



IPCC Category	Gas	Base year emissions (Gg CO <sub>2</sub> e)	2021 emissions (Gg CO <sub>2</sub> e)	Activity data uncertainty (%)	Emission factor uncertainty (%)	Combined uncertainty (%)	Contribution to variance by Category in 2021	Type A sensitivity	Type B sensitivity	Uncertainty in trend in national emissions introduced by emission factor / estimation parameter uncertainty	Uncertainty in trend in national emissions introduced by activity data uncertainty	Uncertainty introduced into the trend in total national emissions
1A3b DERV	N <sub>2</sub> O	288.98	805.91	1.00%	130.00%	130.0%	0.0000	0.080%	0.098%	0.1037%	0.0014%	0.0001%
1A3b Gasoline/ LPG	N <sub>2</sub> O	887.83	74.45	1.00%	74.64%	74.6%	0.0000	0.048%	0.009%	0.0357%	0.0001%	0.0000%
1A3c Coal	N <sub>2</sub> O	-	0.07	20.00%	110.00%	111.8%	0.0000	0.000%	0.000%	0.0000%	0.0000%	0.0000%
1A3d Marine fuel	N <sub>2</sub> O	93.38	56.78	17.72%	115.18%	116.5%	0.0000	0.001%	0.007%	0.0011%	0.0017%	0.0000%
1B1 Fugitive Emissions from Solid Fuels	N <sub>2</sub> O	0.08	0.02	1.00%	118.00%	118.0%	0.0000	0.000%	0.000%	0.0000%	0.0000%	0.0000%
1B2 Oil & Natural Gas	N <sub>2</sub> O	39.74	22.21	4.92%	98.46%	98.6%	0.0000	0.000%	0.003%	0.0002%	0.0002%	0.0000%
2B Chemical industries	N <sub>2</sub> O	21,162.10	29.05	0.25%	10.01%	10.0%	0.0000	1.351%	0.004%	0.1352%	0.0000%	0.0002%
2C Iron & Steel	N <sub>2</sub> O	18.43	6.54	1.00%	118.00%	118.0%	0.0000	0.000%	0.001%	0.0005%	0.0000%	0.0000%
2D Non-energy Products from Fuels and Solvent Use	N <sub>2</sub> O	-	-	0.00%	0.00%	0.0%	-	0.000%	0.000%	0.0000%	0.0000%	0.0000%
2G Other Product Manufacture and Use	N <sub>2</sub> O	533.61	666.17	100.00%	100.00%	141.4%	0.0000	0.047%	0.081%	0.0471%	0.1149%	0.0002%

IPCC Category	Gas	Base year emissions (Gg CO <sub>2</sub> e)	2021 emissions (Gg CO <sub>2</sub> e)	Activity data uncertainty (%)	Emission factor uncertainty (%)	Combined uncertainty (%)	Contribution to variance by Category in 2021	Type A sensitivity	Type B sensitivity	Uncertainty in trend in national emissions introduced by emission factor / estimation parameter uncertainty	Uncertainty in trend in national emissions introduced by activity data uncertainty	Uncertainty introduced into the trend in total national emissions
3B Manure Management	N <sub>2</sub> O	3,038.90	2,493.71	0.00%	22.66%	22.7%	0.0000	0.109%	0.304%	0.0248%	0.0000%	0.0000%
3D Agricultural Soils	N <sub>2</sub> O	13,428.41	10,999.18	0.00%	16.32%	16.3%	0.0000	0.481%	1.341%	0.0786%	0.0000%	0.0001%
3F Field Burning	N <sub>2</sub> O	51.40	-	25.62%	0.00%	25.6%	-	0.003%	0.000%	0.0000%	0.0000%	0.0000%
3J OT & CD Agriculture	N <sub>2</sub> O	155.42	103.91	50.00%	50.00%	70.7%	0.0000	0.003%	0.013%	0.0014%	0.0090%	0.0000%
4 Indirect LULUCF Emissions	N <sub>2</sub> O	271.94	152.89	1.00%	165.00%	165.0%	0.0000	0.001%	0.019%	0.0020%	0.0003%	0.0000%
4A Forest land	N <sub>2</sub> O	438.95	377.40	1.00%	85.00%	85.0%	0.0000	0.018%	0.046%	0.0152%	0.0007%	0.0000%
4B Cropland	N <sub>2</sub> O	653.25	354.68	1.00%	35.00%	35.0%	0.0000	0.001%	0.043%	0.0005%	0.0006%	0.0000%
4C Grassland	N <sub>2</sub> O	134.86	127.67	1.00%	45.00%	45.0%	0.0000	0.007%	0.016%	0.0031%	0.0002%	0.0000%
4D Wetland	N <sub>2</sub> O	18.90	21.42	1.00%	90.00%	90.0%	0.0000	0.001%	0.003%	0.0013%	0.0000%	0.0000%
4E Settlements	N <sub>2</sub> O	392.31	254.78	1.00%	130.00%	130.0%	0.0000	0.006%	0.031%	0.0077%	0.0004%	0.0000%
5B Biological treatment of solid waste	N <sub>2</sub> O	12.36	660.50	30.00%	90.00%	94.9%	0.0000	0.080%	0.081%	0.0718%	0.0342%	0.0001%
5C Waste Incineration	N <sub>2</sub> O	61.44	35.35	7.00%	230.00%	230.1%	0.0000	0.000%	0.004%	0.0009%	0.0004%	0.0000%

IPCC Category	Gas	Base year emissions (Gg CO <sub>2</sub> e)	2021 emissions (Gg CO <sub>2</sub> e)	Activity data uncertainty (%)	Emission factor uncertainty (%)	Combined uncertainty (%)	Contribution to variance by Category in 2021	Type A sensitivity	Type B sensitivity	Uncertainty in trend in national emissions introduced by emission factor / estimation parameter uncertainty	Uncertainty in trend in national emissions introduced by activity data uncertainty	Uncertainty introduced into the trend in total national emissions
5D Wastewater Handling	N <sub>2</sub> O	796.37	903.51	9.29%	216.60%	216.8%	0.0000	0.059%	0.110%	0.1282%	0.0145%	0.0002%
2C Metal Industries	SF <sub>6</sub>	399.06	38.42	5.00%	5.00%	7.1%	0.0000	0.021%	0.005%	0.0010%	0.0003%	0.0000%
2G Other Product Manufacture and Use	SF <sub>6</sub>	891.81	383.40	0.00%	5.52%	5.5%	0.0000	0.010%	0.047%	0.0006%	0.0000%	0.0000%
2B Chemical industry	HFCs	14,807.32	-	0.00%	10.00%	10.0%	-	0.948%	0.000%	0.0948%	0.0000%	0.0001%
2C Metal Industries	HFCs	-	2.26	5.00%	10.00%	11.2%	0.0000	0.000%	0.000%	0.0000%	0.0000%	0.0000%
2E Electronics Industry	HFCs	10.84	19.10	0.00%	47.15%	47.1%	0.0000	0.002%	0.002%	0.0008%	0.0000%	0.0000%
2F Product Uses as Substitutes for ODS	HFCs	801.49	10,798.35	8.50%	8.57%	12.1%	0.0000	1.265%	1.317%	0.1084%	0.1582%	0.0004%
2E Electronics Industry	NF <sub>3</sub>	0.26	0.34	0.00%	47.15%	47.1%	0.0000	0.000%	0.000%	0.0000%	0.0000%	0.0000%
2B Chemical industry	PFCs	104.34	120.85	0.00%	10.00%	10.0%	0.0000	0.008%	0.015%	0.0008%	0.0000%	0.0000%
2C Metal Industries	PFCs	299.84	4.32	0.00%	20.00%	20.0%	0.0000	0.019%	0.001%	0.0037%	0.0000%	0.0000%

IPCC Category	Gas	Base year emissions (Gg CO <sub>2</sub> e)	2021 emissions (Gg CO <sub>2</sub> e)	Activity data uncertainty (%)	Emission factor uncertainty (%)	Combined uncertainty (%)	Contribution to variance by Category in 2021	Type A sensitivity	Type B sensitivity	Uncertainty in trend in national emissions introduced by emission factor / estimation parameter uncertainty	Uncertainty in trend in national emissions introduced by activity data uncertainty	Uncertainty introduced into the trend in total national emissions
2F Product Uses as Substitutes for ODS	PFCs	0.46	-	0.00%	25.00%	25.0%	-	0.000%	0.000%	0.0000%	0.0000%	0.0000%
2G Other Product Manufacture and Use	PFCs	128.63	67.70	0.00%	47.15%	47.1%	0.0000	0.0000%	0.0083%	0.0000%	0.0000%	0.0000%

Percentage uncertainty UNFCCC inventory:	in	2.4%
--	----	------

UNFCCC trend uncertainty	1.6%
--------------------------	------

## **A 2.2 ESTIMATION OF UNCERTAINTY BY SIMULATION (APPROACH 2)**

### **A 2.2.1 Overview of the Method**

Quantitative estimates of the uncertainties in the emissions were calculated using a Monte Carlo simulation. This corresponds to the IPCC Approach 2 method, discussed in the 2006 Guidelines (IPCC, 2006). The background to the implementation of the Monte Carlo simulation is described in detail by Eggleston *et al* (1998), with the estimates reported here revised to reflect changes in the latest inventory and improvements made in the model. This section gives a brief summary of the methodology, assumptions and results of the simulation.

The computational procedure is detailed below.

- A probability distribution function (PDF) was allocated to each unique emission factor and piece of activity data. The PDFs were mostly normal or log-normal, with more specific distributions given to a handful of sources. The parameters of the PDFs were set by analysing the available data on emission factors and activity data, and by expert judgement;
- A calculation was set up to estimate the total emissions of each gas for the years 1990 and the latest reported year;
- Each PDF was sampled at least 20,000 times, such that the emission calculations performed produced a converged output distribution;
- The distribution of errors in the parameter values was calculated from the difference between 2.5 and 97.5 percentile values in the distribution, as a percentage of the distribution mean; and,
- The uncertainty in the trend between 1990 and the latest reported year, according to gas, was also estimated. This was calculated as the latest year sample minus the 1990 sample, divided by the 1990 mean.

### **A 2.2.2 Methodological details of the Monte Carlo model**

#### **A 2.2.2.1 Uncertainty Distributions**

Nearly all of the distributions of emissions from sources in the inventory are modelled using normal or log normal distributions, with more specific distributions given to a handful of sources. The specific distributions include log-logistic and gamma distributions. The primary use of custom distributions is for agriculture; these are fitted distributions that reflect the results of an agriculture-specific Monte Carlo analysis done by Rothamsted Research which accounts for the various factors that influence the modelled agriculture emissions.

Emissions from landfill have been modelled using a custom distribution. Aitchison *et al.* (cited in Eggleston *et al.*, 1998) estimated the uncertainty for landfill emissions using Monte Carlo analysis and found it to be skewed. The distribution histogram was used to generate an empirical distribution of emissions. We examined the distribution and fitted a log normal distribution to Aitchison's data. The emissions are scaled according to the mean estimate of landfill emissions for each year.

There are a couple of other specific distributions for F-gases and wastewater which reflect specific distributions we expect for those sources.

**A 2.2.2.2 Correlations**

The Monte Carlo model contains a number of correlations. If A and B are correlated, then if emissions are under or overestimated from A it would be expected to be over or underestimated by a similar amount from B.

The type and implementation of the correlations has been examined as part of a review (Abbott *et al.*, 2007). The sensitivity analysis that we have completed on the Monte Carlo model suggest that the uncertainties are not sensitive to the correlations between emission factors for fuel used, and for LULUCF sources.

**A 2.2.2.2.1 Across years**

In running this simulation, it was necessary to make assumptions about the degree of correlation between sources in 1990 and the latest reported year. If source emission factors are correlated this will have the effect of reducing the trend uncertainty but will not affect uncertainties on emission totals in 1990 or the latest inventory year. The trend estimated by the Monte Carlo model is particularly sensitive to N<sub>2</sub>O emissions from agricultural soils.

**A 2.2.2.2.2 Between Sources in the same year**

In many cases the same factors, or factors derived on the same basis are used for multiple sources. In these cases, we'd say that the emission factors are correlated. For example, the coal emissions factors for N<sub>2</sub>O used for cement industry use may be the same as coal use in other industrial combustion due to lack of a more specific factor, in this case we may say the two factors are correlated. Omitting these correlations leads to an underestimate of uncertainty in any given year.

**A 2.2.2.3 Simulation Method**

Following recommendations in the 2006 IPCC Guidelines, the model uses a true Monte Carlo sampling method.

**A 2.2.3 Quality Control Checks on the Monte Carlo Model Output**

A number of quality control checks are completed as part of the uncertainty analysis.

**A 2.2.3.1 Checks against totals of the national emissions**

To ensure the emissions in the Monte Carlo model closely agree with the reported totals in the NIR, the emissions in the model were checked against the national totals both before and after the simulation was run. The central estimates from the model are expected to be similar to the reported emissions totals but are not expected to match exactly.

**A 2.2.3.2 Inter-comparison between the output of the error propagation and Monte Carlo models**

A formal check to compare the output of the error propagation and Monte Carlo model is completed. The results of this comparison are discussed in **Section A 2.6**.

**A 2.2.3.3 Calculation of uncertainty on the total**

The uncertainty on the 1990 and the most recent year emissions was calculated using two different methods;

- i) Using  $\frac{1.96 s.d}{\mu}$
- ii) Using  $\frac{(97.5 \text{ percentile} - 2.5 \text{ percentile})}{2 \times \mu}$

The first method uses the standard deviation calculated by the simulation and the mean to give a percentage uncertainty, while the second method uses the 95% confidence interval given by the percentiles quoted. When a distribution is completely normally distributed, the two methods should give the same results. However, when a distribution is skewed the two methods diverge, since the variance is dominated by outliers which aren't necessarily accounted for in the 95% confidence interval.

Calculating the uncertainty using both of these methods allows us to check that the Monte Carlo analysis is behaving in the way we would expect, and that convergence of the distributions is being achieved. Comparing the results using both calculations showed that the uncertainties were almost the same for gases where the distributions used were predominantly normal, but higher for N<sub>2</sub>O and the GWP weighted total, as expected.

## A 2.3 UNCERTAINTY PARAMETERS

The following sections present the uncertainties in emissions, and the trend in emissions according to gas.

### A 2.3.1 Uncertainty Parameters used

**Table A 2.3.1** to **Table A 2.3.4** summarise the uncertainty parameters used for both Approach 1 and 2 uncertainties. For all of these tables the following apply:

- Uncertainties expressed as  $0.5 \times R/E$  where R is the difference between 2.5 and 97.5 percentiles and E is the mean;
- Where custom distributions are used for the Approach 2 uncertainties the parameters are not used directly, but the below parameters should still be a reasonable indicator of the uncertainty in the distribution used for Approach 2;
- (r) means revised in comparison to previous NIR;
- (n) represents a new uncertainty parameter, either because sources are considered at a more granular level, or because a new source is included in the inventory; and
- (a) means uncertainty for emission factors and activity cannot be separated, so one uncertainty that represents both is displayed.

**Table A 2.3.1 Uncertainties in the activity data and emission factors for fuels used in the carbon dioxide (CO<sub>2</sub>) inventory**

Category	Fuel	1990 Activity uncertainty (%)	1990 Emission factor uncertainty (%)	2021 Activity uncertainty (%)	2021 Emission factor uncertainty (%)	Justification for key sources
1A	Lubricants	50.00%	5.00%	50.00%	5.00%	It's challenging to determine the proportion of lubricant used as a fuel, hence a high activity uncertainty.
1A1	Blast Furnace Gas	1.50%	10.00%	1.00%	10.00%	Overall uncertainty for all coke & steelmaking emissions is quite low but allocation to individual sources is definitely higher - we've assumed 10%
1A1	Coke Oven Coke	1.00%	10.00%	1.00%	10.00%	Overall uncertainty for all coke & steelmaking emissions is quite low but allocation to individual sources is definitely higher - we've assumed 10%
1A1	Coke Oven Gas	1.50%	10.00%	1.00%	10.00%	Overall uncertainty for all coke & steelmaking emissions is quite low but allocation to individual sources is definitely higher - we've assumed 10%
1A1	Colliery Methane	5.00%	5.00%	5.00%	5.00%	(Minor fuel in sector context)
1A1	Gas/Diesel Oil	20.00%	2.00%	5.00%	2.00%	Dominated by activity in 1A1cii. There may be limited gas oil use unreported by e.g. MODUs in latest year; base year notably higher as the inventory AD are derived from sector-wide reported data, to address known under-reports in DUKES. Typically, gas oil Carbon emission factors reported are within 1% of each other but occasional deviations further.
1A1	Liquefied Petroleum Gas	25.70%	2.10%	2.50%	2.10%	The DUKES data from 2009 onwards were revised considerably in the energy / NEU split for LPG, and we have created a new split for earlier years. Chosen 2.1% Emission Factor (EF) uncertainty to be consistent with gas oil - the makeup of LPG is well understood and documented



Category	Fuel	1990 Activity uncertainty (%)	1990 Emission factor uncertainty (%)	2021 Activity uncertainty (%)	2021 Emission factor uncertainty (%)	Justification for key sources
1A1	Motor Gasoline	2.50%	2.10%	2.50%	2.10%	Outside of 1A3, the motor gasoline allocations are probably much more uncertain as they are reliant on the off-road model etc., so chosen 2.5%.
1A1	Municipal Solid Waste	1.00%	15.00%	1.00%	15.00%	MSW quantity is known accurately. Uncertainty is in mass of fossil carbon per tonne of residual MSW. This is based on reasonable waste composition data from peer reviewed sources, adapted from landfill data.
1A1	Naphtha	50.00%	5.00%	50.00%	5.00%	DUKES are uncertain about where naphtha is used (or not), so a high activity uncertainty has been chosen. EF uncertainty chosen as 5%. The content of naphtha is quite variable - it contains a huge range of hydrocarbons from C5 up to C70+, so the exact carbon content is variable and there are about 5 different grades of naphtha according to UKPIA.
1A1	Natural Gas	20.00%	2.00%	1.00%	2.00%	ETS-based data, so low uncertainties. Base year activity is dominated by 1A1cii, where uncertainty is notably higher as the inventory AD are derived from sector-wide reported data, to address known under-reports in DUKES.
1A1	Orimulsion	5.00%	5.00%	5.00%	5.00%	(Minor fuel in sector context)
1A1	Other Bituminous Coal	2.00%	2.00%	2.00%	2.00%	ETS-based data, so low uncertainties.
1A1	Other Kerosene	1.25%	5.00%	1.25%	5.00%	ETS-based data, so low uncertainties.
1A1	Other Oil: Other	11.90%	5.00%	10.00%	5.00%	(Minor fuel in sector context)

Category	Fuel	1990 Activity uncertainty (%)	1990 Emission factor uncertainty (%)	2021 Activity uncertainty (%)	2021 Emission factor uncertainty (%)	Justification for key sources
1A1	Petroleum Coke	7.80%	10.00%	5.00%	10.00%	ETS-based data, so low uncertainties. 10% chosen for EF uncertainty as there is only a small dataset for the quality of petcoke used in the sector and the CEF could be quite variable depending on the source of the petcoke.
1A1	Refinery Gas	50.00%	20.00%	25.00%	15.00%	Comparisons between EU ETS and DUKES are variable over time. Risk that in earlier years the "own use" may have been mis-reported to energy stats. High uncertainty on AD. Also, a variable quality fuel, so the EF is also uncertain.
1A1	Residual Fuel Oil	5.50%	2.55%	1.25%	2.55%	ETS-based data, so low uncertainties.
1A1	Scrap Tyres	15.00%	10.00%	15.00%	10.00%	Limited reported use of this fuel; only a small amount of reporting (typically cement kilns) within EU ETS and a modest number of fuel quality analyses either through the BCA/MPA (trade body) or the EU ETS. Also, some variability in the fossil C versus bio-C content of the tyres adds to EF uncertainty.
1A2	Blast Furnace Gas	1.50%	10.00%	1.00%	10.00%	Overall uncertainty for all coke & steelmaking emissions is quite low but allocation to individual sources is definitely higher - we've assumed 10%
1A2	Coke Oven Coke	3.00%	10.00%	1.00%	10.00%	Overall uncertainty for all coke & steelmaking emissions is quite low but allocation to individual sources is definitely higher - we've assumed 10%
1A2	Coke Oven Gas	3.00%	10.00%	1.00%	10.00%	Overall uncertainty for all coke & steelmaking emissions is quite low but allocation to individual sources is definitely higher - we've assumed 10%
1A2	Colliery Methane	5.00%	5.00%	5.00%	5.00%	(Minor fuel in sector context)

Category	Fuel	1990 Activity uncertainty (%)	1990 Emission factor uncertainty (%)	2021 Activity uncertainty (%)	2021 Emission factor uncertainty (%)	Justification for key sources
1A2	Gas/Diesel Oil	20.00%	2.00%	20.00%	2.00%	Low EF uncertainty as the composition of gas oil is well understood across the time series. The AD for stationary combustion in industrial sectors is quite uncertain, however. DUKES does not distinguish between mobile and stationary sources, and other AD data sources (e.g. EU ETS) have limited coverage of gas oil use across all of 1A2.
1A2	Liquefied Petroleum Gas	25.70%	2.10%	2.50%	2.10%	The DUKES data from 2009 onwards were revised considerably in the energy / NEU split for LPG, and we have created a new split for earlier years. Chosen 2.1% EF uncertainty to be consistent with gas oil - the makeup of LPG is well understood and documented
1A2	Motor Gasoline	20.00%	2.10%	20.00%	2.10%	Outside of 1A3, the motor gasoline allocations are probably much more uncertain. Chosen 2.1% EF uncertainty to be consistent with gas oil - the makeup of motor gasoline is well understood and documented
1A2	Municipal Solid Waste	5.00%	15.00%	5.00%	15.00%	MSW quantity is known accurately. Uncertainty is in mass of fossil carbon per tonne of residual MSW. This is based on reasonable waste composition data from peer reviewed sources, adapted from landfill data.
1A2	Natural Gas	2.80%	3.00%	1.00%	3.00%	Low EF uncertainty as gas composition is monitored and reported across much of the time series, and the fuel has narrow compositional range. AD are also well understood and low uncertainty. Gas supplier data to DUKES can be checked against periodic data matching (meter point data against industry sector information).
1A2	non-fuel combustion	50.00%	100.00%	50.00%	100.00%	(Minor emission source in sector context)

Category	Fuel	1990 Activity uncertainty (%)	1990 Emission factor uncertainty (%)	2021 Activity uncertainty (%)	2021 Emission factor uncertainty (%)	Justification for key sources
1A2	Other Bituminous Coal	5.00%	10.00%	5.00%	10.00%	Limited compositional data over time (e.g. EU ETS data for coal is incomplete), so EF uncertainty reflects the range of composition of coal types in 1A2. AD uncertainty is moderate for 1A2, reflecting energy supplier reporting to DESNZ.
1A2	Other Kerosene	6.00%	2.00%	6.00%	2.00%	(Minor fuel in sector context)
1A2	Other Oil: Other	5.00%	50.00%	5.00%	3.00%	(Minor fuel in sector context)
1A2	Patent Fuel	10.00%	3.00%	10.00%	3.00%	(Minor fuel in sector context)
1A2	Petroleum Coke	25.00%	15.00%	20.00%	15.00%	EF uncertainty reflects range of petcock composition that may be used for fuel in 1A2. AD uncertainty is quite high as we have limited data from DUKES and not much AD from EU ETS on petcoke use.
1A2	Refinery Gas	50.00%	15.00%	50.00%	15.00%	(Minor fuel in sector context)
1A2	Residual Fuel Oil	5.50%	2.10%	1.50%	2.10%	Low EF uncertainty as the composition of fuel oil is well understood across the time series. The AD uncertainty is low in recent years as the fuel is not widely used other than by larger operators that report under EU ETS. Moderate uncertainty in earlier years when fewer routine annual AD sources.
1A2	Scrap Tyres	15.00%	10.00%	15.00%	10.00%	(See 1A1 comment – same applies here.)
1A3	Aviation Gasoline	20.00%	3.30%	20.00%	3.30%	Activity uncertainty is higher than many other similar fuels because of the uncertainty in the international-domestic split
1A3	Jet Gasoline	20.00%	3.30%	20.00%	3.30%	Activity uncertainty is higher than many other similar fuels because of the uncertainty in the international-domestic split

Category	Fuel	1990 Activity uncertainty (%)	1990 Emission factor uncertainty (%)	2021 Activity uncertainty (%)	2021 Emission factor uncertainty (%)	Justification for key sources
1A3	liquid biofuels	5.00%	5.00%	5.00%	5.00%	Activity data are not very uncertain, as it's taken from RTFO data. There is a total potential range of 10% variability in the fossil fuel carbon content of FAME (i.e. judging from the contents of the different fatty acid types used to synthesize the FAME, the highest content is around 44.8g/kg, whilst the lowest is 40.2g/kg). In reality, these are the extremes, so a lower overall uncertainty is expected. the other liquid biofuels are consumed in much smaller quantities than FAME.
1A3	Other Bituminous Coal	20.00%	6.00%	20.00%	6.00%	(Minor fuel in sector context)
1A3	Other Gas/Diesel Oil	15.00%	2.00%	15.00%	2.00%	(Minor fuel in sector context)
1A3	Natural Gas	5.00%	2.00%	5.00%	2.00%	Using parameters for road transport LPG; note that source is very small.
1A3b	Gas/Diesel Oil	1.80%	2.00%	1.00%	2.00%	Low EF uncertainty as the composition of gas oil is well understood across the time series. Low AD uncertainty as good corroboration between fuel sales data and estimates based on vehicle movement data.
1A3b	Liquefied Petroleum Gas	5.00%	2.00%	5.00%	2.00%	EF uncertainty is consistent with gas oil - the makeup of LPG is well understood and documented. Not a major fuel in the sector but AD are considered moderately uncertain.
1A3b	Motor Gasoline	1.00%	2.00%	1.00%	2.00%	Low EF uncertainty as the composition of petrol is well understood across the time series. Low AD uncertainty as good corroboration between fuel sales data and estimates based on vehicle movement data.
1A3d	Gas/Diesel Oil	20.00%	2.00%	20.00%	2.00%	Activity uncertainty is higher than many other similar fuels because of the uncertainty in the international-domestic split

Category	Fuel	1990 Activity uncertainty (%)	1990 Emission factor uncertainty (%)	2021 Activity uncertainty (%)	2021 Emission factor uncertainty (%)	Justification for key sources
1A3d	Residual Fuel Oil	20.00%	2.00%	20.00%	2.00%	Activity uncertainty is higher than many other similar fuels because of the uncertainty in the international-domestic split
1A4	Anthracite	1.50%	6.00%	1.00%	6.00%	Low AD uncertainty as tax data helps establish residential use. EF uncertainty reflects variability in anthracite composition.
1A4	Coke Oven Coke	3.00%	10.00%	1.00%	10.00%	(Minor fuel in sector context)
1A4	Gas/Diesel Oil	30.00%	2.00%	30.00%	2.00%	Low EF uncertainty as the composition of gas oil is well understood across the time series. High AD uncertainty as scarce data on use of this fuel, e.g. in mobile machinery, in 1A4.
1A4	Gas Works Gas	5.00%	5.00%	5.00%	5.00%	(Minor fuel in sector context)
1A4	Liquefied Petroleum Gas	25.70%	2.10%	2.50%	2.10%	The DUKES data from 2009 onwards were revised considerably in the energy / NEU split for LPG, and we have created a new split for earlier years. Chosen 2.1% EF uncertainty to be consistent with gas oil - the makeup of LPG is well understood and documented
1A4	Motor Gasoline	50.00%	2.00%	50.00%	2.00%	Low EF uncertainty as the composition of petrol is well understood across the time series. High AD uncertainty as scarce data on use of this fuel in mobile machinery in 1A4.
1A4	Natural Gas	2.80%	3.00%	2.00%	3.00%	(As for 1A2)
1A4	Other Bituminous Coal	3.00%	10.00%	3.00%	10.00%	Chosen 3% activity uncertainty as we know that there are some limitations on the coal allocation to small-scale users.

Category	Fuel	1990 Activity uncertainty (%)	1990 Emission factor uncertainty (%)	2021 Activity uncertainty (%)	2021 Emission factor uncertainty (%)	Justification for key sources
1A4	Other Kerosene	3.00%	2.00%	3.00%	2.00%	Low AD uncertainty as tax data helps establish residential use. EF uncertainty reflects narrow range of fuel composition.
1A4	Patent Fuel	3.30%	3.00%	2.00%	3.00%	(Minor fuel in sector context)
1A4	Peat	30.00%	10.00%	30.00%	10.00%	(Minor fuel in sector context)
1A4	Petroleum Coke	20.00%	15.00%	20.00%	15.00%	Limited information on the AD of use in domestic fuels which increases uncertainty. Moderate emission factor uncertainty as there is only a small dataset for the quality of petcoke used in the sector and the CEF could be quite variable depending on the source of the petcoke.
1A4	Residual Fuel Oil	5.50%	2.10%	3.00%	2.10%	(Minor fuel in sector context)
1A5	Gas/Diesel Oil	6.25%	2.05%	6.25%	2.05%	Moderate AD uncertainty as data from very few data suppliers. EF uncertainty reflects narrow range of fuel composition.
1A5	Jet Gasoline	10.00%	3.00%	10.00%	3.00%	Activity Data comes directly from fuel users so should have high confidence.
1B1	Coke Oven Gas	1.50%	10.00%	1.00%	10.00%	(Minor fuel in sector context)
1B1	Other Bituminous Coal	1.50%	6.00%	1.50%	6.00%	EF uncertainty reflects the range of composition of coal types in SSF manufacture. AD uncertainty is quite low, reflecting the small number of operators and high level of AD reporting.
1B1	petroleum coke	20.00%	10.00%	20.00%	10.00%	(Minor fuel in sector context)

Category	Fuel	1990 Activity uncertainty (%)	1990 Emission factor uncertainty (%)	2021 Activity uncertainty (%)	2021 Emission factor uncertainty (%)	Justification for key sources
1B2a	non-fuel combustion	15.00%	20.00%	10.00%	30.00%	The dominant sources are onshore oil production (latest year) and offshore oil well testing (base year). The PPRS data underpin the oil production data and whilst they are very consistent across years, it is plausible that up to 10% error may occur if one of the larger site's mis-reports as these dominate. For the base year, the AD for well testing is extrapolated to 1990 using well drilling statistics so introduces some additional uncertainty. The dominant source in recent years is onshore oil production which applies an IPCC 2019 Refinement Tier 1 EF which cites a 30% uncertainty margin. In the base year due to the (large) dominance of oil well testing, a lower overall EF uncertainty is applied.
1B2b	non-fuel combustion	15.00%	20.00%	2.00%	10.00%	The dominant sources are direct process releases from both offshore gas rigs and terminals (latest year) and gas well testing (base year). The installation-level reporting underpins latest year estimates, and hence low AD estimates and the EF reflects that there is a good dataset with known sites contributing fairly consistently but there may be a reasonably high measurement uncertainty at source. For the base year, the AD for well testing is well documented back to 1995, and then extrapolated to 1990 introducing some additional uncertainty. For the base year, the CEF is only based on operator guidance rather than any monitoring, making it more uncertain.



Category	Fuel	1990 Activity uncertainty (%)	1990 Emission factor uncertainty (%)	2021 Activity uncertainty (%)	2021 Emission factor uncertainty (%)	Justification for key sources
1B2c	non-fuel combustion	20.00%	5.00%	5.00%	5.00%	Flaring emissions dominate this sector in all years. There has been high quality reporting of flaring since around 1995, but the monitoring of gas to flare and need for assumptions to estimate the mass will undermine that to an extent. For the Base Year we have extrapolated back from 1995 so the uncertainty in AD is higher. There is a large dataset on the composition of gas to flare and recent evidence that 98% combustion is accurate <sup>3</sup> . However, if a few sites have notably lower oxidation, this would significantly impact the CEF.
2A1	non-fuel combustion	1.00%	3.00%	1.00%	3.00%	EU ETS-type data collected from BCA for all sites so assume very good quality and complete.
2A2	non-fuel combustion	10.00%	5.00%	(a)	5.00%	High level of reporting in EU ETS for recent years and EF reflects small range of data for carbonates used in lime production. AD uncertainty higher in earlier years.
2A3	non-fuel combustion	(a)	5.00%	(a)	5.00%	Mostly based on ETS data. Very small sites outside EU ETS; it's not certain how well EU ETS factor will apply to these non-EU ETS sites.
2A4	non-fuel combustion	2.00%	3.00%	2.00%	3.00%	(Minor source in UK context)
2B	Coke	1.00%	20.00%	1.00%	10.00%	(Minor source in UK context)
2B	coke oven coke	(a)	20.00%	(a)	20.00%	(Minor source in UK context)

<sup>3</sup> Shaw et al., 2022. Through the analysis of emission plumes in the North Sea between 2018 and 2019, it was found that 98.4% of carbon in flared gas is converted to CO<sub>2</sub>.

Category	Fuel	1990 Activity uncertainty (%)	1990 Emission factor uncertainty (%)	2021 Activity uncertainty (%)	2021 Emission factor uncertainty (%)	Justification for key sources
2B	Natural Gas	2.80%	1.25%	1.75%	1.25%	Covers both feedstock and fuel (i.e. total fuel used at the sites), so AD should be very good.
2B	non-fuel combustion	2.00%	5.00%	2.00%	5.00%	(Minor source in UK context)
2B	OPG	(a)	5.00%	(a)	5.00%	Moderate uncertainty in EF reflecting good level of reporting of fuel quality in EU ETS but range of variability of process off-gases that are generated and used in the chemical sector.
2B	petroleum coke	1.00%	10.00%	1.00%	10.00%	(Minor source in UK context)
2B	refinery gas	30.00%	5.00%	30.00%	5.00%	High uncertainty, as we deviate from DUKES. Low emission factor uncertainty, but not a well-characterised fuel.
2C	Blast Furnace Gas	2.00%	10.00%	2.00%	10.00%	Overall uncertainty in 2C is quite low and uncertainty is more about where the carbon input (from the coking coal) ends up being emitted, and less about the overall amount of carbon emitted.
2C	Coke	2.00%	10.00%	2.00%	10.00%	Good level of reporting from I&S operators across the time series.
2C	coke oven coke	2.00%	5.00%	2.00%	5.00%	Activity data has low uncertainty since it's based on ETS/ISSB/DUKES. Emissions are based on regulator data, so low uncertainty.
2C	non-fuel combustion	2.00%	10.00%	2.00%	10.00%	Overall uncertainty in 2C is quite low and uncertainty is more about where the carbon input (from the coking coal) ends up being emitted, and less about the overall amount of carbon emitted.
2C	Petroleum Coke	10.00%	7.50%	10.00%	7.50%	(Minor source in UK context)

Category	Fuel	1990 Activity uncertainty (%)	1990 Emission factor uncertainty (%)	2021 Activity uncertainty (%)	2021 Emission factor uncertainty (%)	Justification for key sources
2D	Lubricants	50.00%	50.00%	50.00%	50.00%	It's challenging to determine the size of the recovered lubricant market, as this is outside the scope of energy statistics, hence a high activity uncertainty. The fraction of lubricant incidentally oxidised is also highly uncertain, so should be reflected in a high EF uncertainty.
2D	non-fuel combustion	25.00%	2.00%	25.00%	2.00%	Some uncertainty as to the proportion of HDVs requiring urea and how much is needed per vehicle. Very low EF uncertainty because carbon content of urea solution known accurately.
2D	Petroleum Coke	20.00%	30.00%	20.00%	30.00%	(Minor source in UK context)
2D	Petroleum Waxes	10.00%	50.00%	10.00%	50.00%	(Minor source in UK context)
2G		25.00%	2.00%	25.00%	2.00%	High activity uncertainty due to it being unclear if bicarbonate of soda is used for emissive or non-emissive applications. Low uncertainty in emission factors as it's determined from stoichiometry.
3G	non-fuel combustion	(a)	20.90%	(a)	20.90%	Reflects overall uncertainty of AD and EF for carbonate application to soils.
3H	non-fuel combustion	(a)	50.00%	(a)	50.00%	(Minor source in UK context)

Category	Fuel	1990 Activity uncertainty (%)	1990 Emission factor uncertainty (%)	2021 Activity uncertainty (%)	2021 Emission factor uncertainty (%)	Justification for key sources
4A	non-fuel combustion	5.00%	20.00%	5.00%	20.00%	In order to assess the uncertainties for Forest Land a Monte Carlo analysis was performed using the CARBINE model. The probability density functions (PDFs) assigned to the various CARBINE input parameters were based on information from the literature and expert judgement. A selection of 100 sets of input parameters were generated using a Latin hypercube, as this was considered to be the minimum number of model runs to get a reasonable estimate of the uncertainty.
4B	non-fuel combustion	1.00%	25.00%	1.00%	25.00%	High uncertainty reflects modelled assumptions and limited AD and is focussed in the EF parameter.
4C	non-fuel combustion	1.00%	30.00%	1.00%	30.00%	High uncertainty reflects modelled assumptions and limited AD and is focussed in the EF parameter.
4D	non-fuel combustion	1.00%	25.00%	1.00%	25.00%	High uncertainty reflects modelled assumptions and limited AD and is focussed in the EF parameter.
4E	non-fuel combustion	1.00%	25.00%	1.00%	25.00%	High uncertainty reflects modelled assumptions and limited AD and is focussed in the EF parameter.
4F	non-fuel combustion	(a)	50.00%	(a)	50.00%	High uncertainty reflects modelled assumptions and limited AD and is focussed in the EF parameter.

Category	Fuel	1990 Activity uncertainty (%)	1990 Emission factor uncertainty (%)	2021 Activity uncertainty (%)	2021 Emission factor uncertainty (%)	Justification for key sources
4G	non-fuel combustion	1.00%	20.00%	1.00%	15.00%	In order to assess the uncertainties for Forest Land a Monte Carlo analysis was performed using the CARBINE model. The probability density functions (PDFs) assigned to the various CARBINE input parameters were based on information from the literature and expert judgement. A selection of 100 sets of input parameters were generated using a Latin hypercube, as this was considered to be the minimum number of model runs to get a reasonable estimate of the uncertainty.
5C	Chemical waste	300.00%	40.00%	10.00%	30.00%	(Minor source in UK context)
5C	Clinical waste	300.00%	40.00%	5.00%	20.00%	(Minor source in UK context)
5C	Municipal Solid Waste	300.00%	40.00%	1.00%	15.00%	(Minor source in UK context)
5C	non-fuel combustion	300.00%	40.00%	300.00%	40.00%	Unauthorised and widely dispersed activity estimated from indirect data sources so high uncertainty. Significant uncertainty in the composition of material burnt.
5C	Small scale waste burning	300.00% (n)	100.00% (n)	300.00% (n)	100.00% (n)	Activity data taken from a relatively new survey with high uncertainty (confidence in this source may improve in future years). High EF uncertainty due to the variability of waste being burnt and its biogenic content.

**Table A 2.3.2 Estimated uncertainties in the activity data and emission factors used in the methane (CH<sub>4</sub>) inventory**

Category	Fuel	1990 Activity uncertainty (%)	1990 Emission factor uncertainty (%)	2021 Activity uncertainty (%)	2021 Emission factor uncertainty (%)	Justification for key sources
1A1	All Fuels	10.00%	50.00%	1.00%	50.00%	Minor source but uncertainty mainly reflects uncertainty in the EF from combustion of biomass.  A large proportion of base year emissions are associated with 1A1ciii data which are extrapolated based on production trends, therefore has a higher uncertainty than the 1A1a-dominated emissions in later years.
1A2	All Fuels	1.50%	50.00%	1.00%	50.00%	As above.
1A3	Aviation Gasoline	20.00%	78.50%	20.00%	78.50%	(Minor source in UK context)
1A3	Jet Gasoline	20.00%	78.50%	20.00%	78.50%	(Minor source in UK context)
1A3	Other Bituminous Coal	20.00%	110.00%	20.00%	110.00%	(Minor source in UK context)
1A3	Other Gas/Diesel Oil	15.00%	130.00%	15.00%	130.00%	(Minor source in UK context)
1A3	Natural Gas	5.00%	130.00%	5.00%	130.00%	Using parameters for road transport LPG; note that source is very small.
1A3b	Gas/Diesel Oil	1.80%	130.00%	1.00%	130.00%	Road transport fuel sales well documented, so uncertainty in AD should be low. Uncertainty in EF reflects the variability in EFs for the range of vehicle (car, van, HGV) and road types.
1A3b	Liquefied Petroleum Gas	5.00%	130.00%	5.00%	130.00%	(Minor source in UK context)

Category	Fuel	1990 Activity uncertainty (%)	1990 Emission factor uncertainty (%)	2021 Activity uncertainty (%)	2021 Emission factor uncertainty (%)	Justification for key sources
1A3b	Motor Gasoline	1.00%	75.00%	1.00%	75.00%	Road transport dominates consumption of these fuels, so uncertainty in AD should be low. Uncertainty in EF reflects the variability in EFs for petrol cars and road types. Lower uncertainty than diesel vehicles because consumption dominated by only one vehicle type.
1A3d	Gas/Diesel Oil	20.00%	130.00%	20.00%	130.00%	Uncertainty in AD due to uncertainty in getting domestic/international split from bottom-up method. Uncertainty in EF should be consistent with other 1A3 gas oil
1A3d	Residual Fuel Oil	20.00%	130.00%	20.00%	130.00%	Uncertainty in AD due to uncertainty in getting domestic/international split from bottom-up method.
1A4		1.50%	50.00%	1.00%	50.00%	Minor source but uncertainty mainly reflects uncertainty in the EF from combustion of biomass.
1A5		7.07%	65.55%	7.07%	65.55%	(Minor source in UK context)
1B1	Coke Oven Gas	1.50%	50.00%	1.00%	50.00%	(Minor source in UK context)
1B1	non-fuel combustion	2.00%	20.00%	2.00%	20.00%	High EF uncertainty reflects the modelled estimates of emissions from coal mines.
1B1	wood	(a)	50.00%	(a)	50.00%	(Minor source in UK context)

Category	Fuel	1990 Activity uncertainty (%)	1990 Emission factor uncertainty (%)	2021 Activity uncertainty (%)	2021 Emission factor uncertainty (%)	Justification for key sources
1B2a	non-fuel combustion	20.00%	50.00%	5.00%	50.00%	Latest year methane 1B2a is dominated by direct process fugitives from offshore oil rigs and oil terminals and oil loading. In all cases the AD are of reasonable quality from installation-level reporting (the oil loading AD are from production stats, of good quality). Base year AD are more uncertain; industry reporting is not source-specific and IPCC good practice gap-filling methods are used to derive 1990-1994 estimates. The 2019 Refinement cites 50% uncertainty for direct process / fugitive EFs.
1B2b	non-fuel combustion	20.00%	50.00%	5.00%	50.00%	Latest year methane 1B2b is dominated by direct process fugitives from offshore gas rigs gas oil terminals and from onshore gas production and gathering. In all cases the AD are of reasonable quality from installation-level reporting. Base year AD are more uncertain; industry reporting is not source-specific and IPCC good practice gap-filling methods are used to derive 1990-1994 estimates. The 2019 Refinement cites 10-20% uncertainty for direct process / fugitives EFs whilst the IPCC default uncertainty for process fugitives is 100%. The UK applies 50% as a compromise between these values.



Category	Fuel	1990 Activity uncertainty (%)	1990 Emission factor uncertainty (%)	2021 Activity uncertainty (%)	2021 Emission factor uncertainty (%)	Justification for key sources
1B2c	non-fuel combustion	20.00%	100.00%	5.00%	100.00%	Flaring and venting both contribute a high share of total sector emissions in all years. Operator reporting informs flaring and venting emissions since 1995; accuracy will be limited by measurement uncertainty on gas to flare/vent and assumptions applied. Base year AD are more uncertain; industry reporting is not source-specific and IPCC good practice gap-filling methods are used to derive 1990-1994 estimates. Flaring uncertainty dominates as operators assume that flare gas is 98% oxidised. This is supported by recent evidence <sup>4</sup> , however emissions would increase greatly if the largest sites have notably lower oxidation.
2A4		(a)	100.00%	(a)	100.00%	(Minor source in UK context)
2B		(a)	20.00%	(a)	20.00%	(Minor source in UK context)
2C	Blast Furnace Gas	2.00%	50.00%	2.00%	50.00%	(Minor source in UK context)
2C	coke oven coke	2.00%	50.00%	2.00%	50.00%	Activity data has low uncertainty since it's based on ETS/ISSB/DUKES. Emissions are based on literature factors, so a high EF uncertainty.
2C	non-fuel combustion	1.00%	50.00%	1.00%	50.00%	(Minor source in UK context)
2D		50.00%	50.00%	50.00%	50.00%	(Minor source in UK context)
3A	non-fuel combustion	13.73%	(a)	13.73%	(a)	Based on monte Carlo analysis for the agriculture model
3B	non-fuel combustion	(a)	8.37%	(a)	8.37%	Based on monte Carlo analysis for the agriculture model

<sup>4</sup> Shaw et al., 2022. Through the analysis of emission plumes in the North Sea between 2018 and 2019, it was found that 98.4% of carbon in flared gas is converted to CO<sub>2</sub>.

Category	Fuel	1990 Activity uncertainty (%)	1990 Emission factor uncertainty (%)	2021 Activity uncertainty (%)	2021 Emission factor uncertainty (%)	Justification for key sources
3F	non-fuel combustion	25.61%	(a)	25.61%	(a)	Based on monte Carlo analysis for the agriculture model
3J		50.00%	50.00%	50.00%	50.00%	
4A	non-fuel combustion	5.00%	90.00%	5.00%	70.00%	(Minor source in UK context)
4B	non-fuel combustion	1.00%	90.00%	1.00%	90.00%	(Minor source in UK context)
4C	non-fuel combustion	1.00%	40.00%	1.00%	40.00%	(Minor source in UK context)
4D	non-fuel combustion	1.00%	40.00%	1.00%	35.00%	(Minor source in UK context)
4E	non-fuel combustion	1.00%	50.00%	1.00%	40.00%	(Minor source in UK context)
5A	non-fuel combustion	15.00%	46.00%	15.00%	46.00%	Moderate/high uncertainty in historical waste data, rates of decomposition and generation of methane in the modelled approach. Some extrapolation of data needed for methane utilisation, hence high uncertainty overall, across AD and EF.
5B		30.00%	99.50%	30.00%	99.50%	Scarce data for UK biological treatments. High uncertainty.
5C	Municipal Solid Waste	5.00%	75.00%	1.00%	75.00%	(Minor source in UK context)
5C	non-fuel combustion	5.00%	50.00%	5.00%	50.00%	(Minor source in UK context)
5C	Small scale waste burning	300.00% (n)	100.00% (n)	300.00% (n)	100.00% (n)	Activity data taken from a relatively new survey with high uncertainty (confidence in this source may improve in future years). The EF uncertainty is the default suggested in the 2006 IPCC guidelines.
5C	wood	300.00% (r)	50.00%	300.00% (r)	40.00% (r)	(Minor source in UK context)
5D1	non-fuel combustion	10.00%	25.00%	10.00%	25.00%	UK industry research and model. Moderate-high uncertainty.

Category	Fuel	1990 Activity uncertainty (%)	1990 Emission factor uncertainty (%)	2021 Activity uncertainty (%)	2021 Emission factor uncertainty (%)	Justification for key sources
5D2		25.00%	82.54%	25.00%	82.54%	Calculated based on 2006 IPCC guidelines ranges for model parameters and weighted depending on their contribution to the final emissions estimate.

**Table A 2.3.3 Estimated uncertainties in the activity data and emission factors used in the nitrous oxide (N<sub>2</sub>O) inventory**

Category	Fuel	1990 Activity uncertainty (%)	1990 Emission factor uncertainty (%)	2021 Activity uncertainty (%)	2021 Emission factor uncertainty (%)	Justification for key sources
1A1		1.50%	100.00%	1.00%	100.00%	
1A2		1.50%	100.00%	1.00%	100.00%	
1A3	Aviation Gasoline	20.00%	110.00%	20.00%	110.00%	
1A3	Jet Gasoline	20.00%	110.00%	20.00%	110.00%	
1A3	Other Bituminous Coal	20.00%	110.00%	20.00%	110.00%	
1A3	Other Gas/Diesel Oil	15.00%	130.00%	15.00%	130.00%	
1A3	Natural Gas	5.00%	130.00%	5.00%	130.00%	Using parameters for road transport LPG; note that source is very small.
1A3b	Gas/Diesel Oil	1.80%	130.00%	1.00%	130.00%	Road transport dominates consumption of these fuels, so uncertainty in AD should be low. Uncertainty in EF reflects the variability in EFs for different diesel vehicle types and road types.

Category	Fuel	1990 Activity uncertainty (%)	1990 Emission factor uncertainty (%)	2021 Activity uncertainty (%)	2021 Emission factor uncertainty (%)	Justification for key sources
1A3b	Liquefied Petroleum Gas	5.00%	130.00%	5.00%	130.00%	
1A3b	Motor Gasoline	1.00%	75.00%	1.00%	75.00%	Road transport dominates consumption of these fuels, so uncertainty in AD should be low. Uncertainty in EF reflects the variability in EFs for petrol cars and road types. Lower uncertainty than diesel vehicles because consumption dominated by only one vehicle type.
1A3d	Gas/Diesel Oil	20.00%	130.00%	20.00%	130.00%	Uncertainty in AD due to uncertainty in getting domestic/international split from bottom-up method. Uncertainty in EF should be consistent with other 1A3 gas oil
1A3d	Residual Fuel Oil	20.00%	130.00%	20.00%	130.00%	Uncertainty in AD due to uncertainty in getting domestic/international split from bottom-up method.
1A4		1.50%	100.00%	1.00%	100.00%	
1A5		7.07%	85.15%	7.07%	85.15%	
1B1		1.50%	118.00%	1.00%	118.00%	
1B2a	non-fuel combustion	15.00%	100.00%	10.00%	200.00%	Assume same AD uncertainty as carbon. Most UK reporting is based on operator guidance EFs with very little or no monitoring, so it is only marginally better than using IPCC defaults. The IPCC default uncertainty for nitrous oxide from such process sources is typically 100% or higher. Also note that for onshore oil production (~half of more recent emissions) we use the IPCC default which is -10 to +1000% uncertainty range, so the latest year is more uncertain.

Category	Fuel	1990 Activity uncertainty (%)	1990 Emission factor uncertainty (%)	2021 Activity uncertainty (%)	2021 Emission factor uncertainty (%)	Justification for key sources
1B2b	non-fuel combustion	15.00%	100.00%	2.00%	100.00%	Assume same AD uncertainty as carbon. Most UK reporting is based on operator guidance EFs with very little or no monitoring, so it is only marginally better than using IPCC defaults. The IPCC default uncertainty for nitrous oxide from such process sources is typically 100% or higher.
1B2c	non-fuel combustion	20.00%	100.00%	5.00%	100.00%	Assume same AD uncertainty as carbon. Most UK reporting is based on operator guidance EFs with very little or no monitoring, so it is only marginally better than using IPCC defaults. The IPCC default uncertainty for nitrous oxide from such process sources is typically 100% or higher.
2B1		2.00%	50.00%	2.00%	50.00%	Strong activity data, so low activity uncertainty. Assume a high uncertainty for the literature factor.
2B2		10.00%	100.00%	(a)	10.00%	Emission estimates for recent years have been based partially (1998-2008) or wholly (2009-2017) on continuous monitoring, and therefore will be subject to low uncertainty. The monitoring systems used at the 2 sites currently in operation are subject to an uncertainty of 5-10%. Uncertainty in earlier years is much higher due to more limited information
2B3		2.00%	100.00%	2.00%	100.00%	
2B8		10.00%	100.00%	10.00%	100.00%	
2C		1.50%	118.00%	1.00%	118.00%	
2D		50.00%	100.00%	50.00%	100.00%	
2G		100.00%	100.00%	100.00%	100.00%	

Category	Fuel	1990 Activity uncertainty (%)	1990 Emission factor uncertainty (%)	2021 Activity uncertainty (%)	2021 Emission factor uncertainty (%)	Justification for key sources
3B		(a)	68.07%	(a)	9.53%	Based on separate monte Carlo analysis for the agriculture model
3D		(a)	53.28%	(a)	11.16%	Based on separate monte Carlo analysis for the agriculture model
3F		25.63%	(a)	25.62%	(a)	
3J		50.00%	50.00%	50.00%	50.00%	
4A	non-fuel combustion	1.00%	80.00%	1.00%	80.00%	
4B	non-fuel combustion	1.00%	40.00%	1.00%	40.00%	
4C	non-fuel combustion	1.00%	50.00%	1.00%	45.00%	
4D	non-fuel combustion	1.00%	120.00%	1.00%	65.00%	
4E	non-fuel combustion	1.00%	135.00%	1.00%	130.00%%	
4only	non-fuel combustion	1.00%	165.00%	1.00%	165.00%	
5B		30.00%	90.00%	30.00%	90.00%	
5C		7.00%	230.00%	7.00%	230.00%	
5D1		10.00%	248.00%	10.00%	248.00%	
5D2		25.00%	129.37%	25.00%	129.37%	Calculated based on 2006 IPCC guidelines ranges for model parameters and weighted depending on their contribution to the final emissions estimate.

**Table A 2.3.4 Estimated uncertainties in the activity data and emission factors used in the F-gas inventory**

Category	Fuel	1990 Activity uncertainty (%)	1990 Emission factor uncertainty (%)	2021 Activity uncertainty (%)	2021 Emission factor uncertainty (%)	Justification for key sources
HFCs	2B9	(a)	15.00%	(a)	10.00%	
HFCs	2C4	5.00%	10.00%	5.00%	10.00%	
HFCs	2E1	(a)	44.50%	(a)	47.15%	
HFCs	2F1	10.00%	10.00%	10.00%	10.00%	Good UK data on refrigerant supply is used to tune the model of emissions for this sector, which means that there is a high confidence in the overall estimates of an activity for this sector. Good activity data helps mitigate the uncertainty in emissions, as leakage and disposal is directly linked to refrigerant demand.
HFCs	2F2	(a)	15.00%	(a)	15.00%	
HFCs	2F3	(a)	25.00%	(a)	25.00%	
HFCs	2F4a	5.00%	10.00%	5.00%	10.00%	
HFCs	2F4b	(a)	10.00%	(a)	10.00%	
HFCs	2F5	(a)	25.50%	(a)	25.50%	
HFCs	2F6	(a)	51.00%	(a)	42.00%	
NF <sub>3</sub>	2E1	(a)	44.50%	(a)	47.15%	
PFCs	2B9	(a)	15.00%	(a)	10.00%	
PFCs	2C3	(a)	20.00%	(a)	20.00%	
PFCs	2F3	(a)	25.00%	(a)	25.00%	
PFCs	2G2e	(a)	44.50%	(a)	47.15%	

Category	Fuel	1990 Activity uncertainty (%)	1990 Emission factor uncertainty (%)	2021 Activity uncertainty (%)	2021 Emission factor uncertainty (%)	Justification for key sources
SF <sub>6</sub>	2C4	5.00%	5.00%	5.00%	5.00%	
SF <sub>6</sub>	2G1	(a)	20.00%	(a)	5.00%	
SF <sub>6</sub>	2G2a	(a)	50.00%	(a)	50.00%	
SF <sub>6</sub>	2G2b	(a)	17.50%	(a)	15.50%	
SF <sub>6</sub>	2G2e	(a)	40.00%	(a)	10.00%	



### A 2.3.2 General Considerations

The uncertainty parameters presented above are based primarily on expert judgment, but where applicable will account for:

- The uncertainty range presented for data (for example the confidence interval in the 2006 IPCC guidelines for default factors)
- Monte Carlo Analysis of some of the more sophisticated models, most notably for agriculture, LULUCF and F-gases

In some cases, the individual uncertainties for the activity data and the emission factor are difficult to separate, but the uncertainty on the total emission can more easily be estimated. In these cases, the uncertainties are listed in the columns for emission factor uncertainties.

The analysis of the uncertainties in the nitrous oxide emissions is particularly difficult because emissions sources are diverse, and few data are available to form an assessment of the uncertainties in each source. Emission factor data for the combustion sources are scarce and for some fuels are not available. The uncertainty assumed for agricultural soils (IPCC category 3D) uses a custom distribution. These parameterised functions have been defined and provided by Rothamsted Research as the best possible fit to the expected distribution of uncertainties in 1990 and the most recent year's emissions, and are normalised in the Approach 2 methodology such that the resultant mean is consistent with the current inventory emissions in 1990 and the most recent year.

Many of the uncertainties in the emissions of HFCs, PFCs,  $\text{NF}_3$  and  $\text{SF}_6$  (collectively known as F-gases) are based on the study to update emissions and projections of F-gases (ICF, 2014) in line with the 2006 IPCC guidelines. Some sources have been updated since then and the uncertainties for those sources have been revisited accordingly.

We assume that all F-gas emissions are independent between years as the technologies, gases (which have a very wide range of GWPs) used and regulations have changed drastically between the base year and the most recent year. Many HFCs in particular were not in use until the early 90s.

### A 2.3.3 Uncertainty in the Trend

In simulating trend uncertainty, it was necessary to make assumptions about the degree of correlation between sources and between 1990 and the most recent year. The assumptions were as follows:

- Activity data are uncorrelated;
- Emission factors of some similar fuels are correlated;
- Land Use Change and forestry emission factors are correlated (e.g. 1990 4A  $\text{CO}_2$  with 4A  $\text{CO}_2$  for the most recent year);
- Emission factors covered by the Carbon Factors Review (Baggott et al, 2004) are not correlated;
- Process emissions from blast furnaces, coke ovens and ammonia plants are not correlated;
- Landfill emissions were partly correlated across years in the simulation. It is likely that the emission factors used in the model will be correlated, and also the historical estimates of waste arisings will be correlated since they are estimated by extrapolation from the year

of the study. However, the reduction in emissions is due to flaring and utilisation systems installed since 1990 and this is unlikely to be correlated. As a simple estimate it was assumed that the degree of correlation should reflect the reduction in emissions since 1990;

- Emissions from agricultural soils and manure management are correlated in the base and inventory year;
- The emission factor used for sewage treatment was assumed to be correlated between years, though the protein consumption data used as activity data were assumed not to be correlated between years; and,
- Nitric acid production emission factors were assumed not to be correlated, since the mix of operating plants is very different in the most recent year compared with 1990 – only two of the original eight units are still operating in the latest inventory year, all of which now have differing levels of abatement fitted.

## A 2.4 UNCERTAINTIES IN GWP WEIGHTED EMISSIONS

### A 2.4.1 Uncertainty in the emissions

The uncertainty in the combined GWP weighted emission is given in **Table A 2.4.1**, along with uncertainties for each of the seven categorised GHGs. This is calculated as half of the 95% confidence range, i.e. the limits between which there is a 95% probability that the actual value of emissions falls. Note that the uncertainty in the GWP is not accounted for.

### A 2.4.2 Uncertainty in the Trend

The uncertainty estimates for all gases are summarised in **Table A 2.4.1**. The trend is calculated for each simulation as  $\frac{\text{latest year sample} - 1990 \text{ sample}}{1990 \text{ mean}}$  and the 2.5 and 97.5 percentiles are shown to indicate a 95% confidence range. This can produce different results from a trend calculated as  $\frac{\text{latest year sample} - 1990 \text{ sample}}{1990 \text{ sample}}$ , particularly where simulations of 1990 emissions are near or can go below zero.

Note that the uncertainty in the GWP is not accounted for.

**Table A 2.4.1 Summary of Monte Carlo Uncertainty Estimates**

IPCC Source Category	Gas	1990 Emissions	2021 Emissions	95% confidence interval for 1990 emissions	95% confidence interval for 1990 emissions	Uncertainty in 1990 emissions as % of emissions in category	95% confidence interval for 2021 emissions	95% confidence interval for 2021 emissions	Uncertainty in 2021 emissions as % of emissions in category	Trend in emissions between 1990 and 2021	Uncertainty in the trend in emissions between 1990 and 2021 as % of 1990 emissions <sup>a</sup>	Uncertainty in the trend in emissions between 1990 and 2021 as % of 1990 emissions <sup>a</sup>
				2.5 percentile	97.5 percentile		2.5 percentile	97.5 percentile			2.5 percentile <sup>b</sup>	97.5 percentile
		Gg CO <sub>2e</sub>	Gg CO <sub>2e</sub>	Gg CO <sub>2e</sub>	Gg CO <sub>2e</sub>	%	Gg CO <sub>2e</sub>	Gg CO <sub>2e</sub>	%	%	%	%
TOTAL	CO <sub>2</sub> (net)	607,318	342,572	596,771	617,961	1.7%	336,120	348,923	1.9%	-44%	-45%	-42%
	CH <sub>4</sub>	150,780	57,391	120,944	193,808	24.2%	50,833	66,226	13.4%	-62%	-91%	-42%
	N <sub>2</sub> O	44,398	19,195	33,990	60,374	29.7%	16,698	23,027	16.5%	-57%	-93%	-33%
	HFC	12,072	10,821	10,259	13,887	15.0%	9,756	11,888	9.9%	-10%	-28%	7%
	PFC	1,486	193	1,203	1,766	18.9%	162	229	17.5%	-87%	-106%	-68%
	SF <sub>6</sub>	1,243	422	1,114	1,375	10.5%	402	442	4.8%	-66%	-77%	-55%
	NF <sub>3</sub>	0.1	0.3	0.1	0.2	43.9%	0.2	0.5	47.2%	207%	68%	369%
	<b>All</b>	<b>817,297</b>	<b>430,594</b>	<b>782,557</b>	<b>863,689</b>	<b>5.0%</b>	<b>420,684</b>	<b>441,909</b>	<b>2.5%</b>	<b>-47%</b>	<b>-53%</b>	<b>-43%</b>

Uncertainty calculated as 0.5\*R/E where R is the difference between 2.5 and 97.5 percentiles and E is the mean calculated in the simulation.

Emissions of CO<sub>2</sub> are net emissions (i.e. sum of emissions and removals).

Emissions in this table are taken from the Monte Carlo model output. The central estimates, according to gas, for 1990 and the latest inventory year are very similar but not identical to the emission estimates in the inventory. The Executive Summary of this NIR and the accompanying CRF tables present the agreed national GHG emissions and removals reported to the UNFCCC.

<sup>a</sup> What is specifically presented here is the 95% confidence interval for the change in emissions as a percentage of 1990 emissions; this is different to the 95% confidence interval of the percentage changes since 1990.

<sup>b</sup> Note that for categories where emissions have completely or almost completely stopped being generated in the latest year (i.e. has a trend of near -100%), the 2.5 percentile for the trend might be presented as a decline of over 100%. This should not be interpreted to mean that emissions might now be negative, instead this reflects that due to uncertainty in the emission estimates, the decline in emissions might be greater than the mean estimate for the base year. The below simplified example illustrates how this might occur.

If:

- Base year emissions for a category is estimated to be 1 Mt CO<sub>2</sub>e
- Latest year emissions for a category is estimated to be 0 Mt CO<sub>2</sub>e
- Uncertainty in the base year and latest year emissions estimate is 10%

Then:

- The central estimate for the trend is -100%
- The lower limit for the trend (in Mt CO<sub>2</sub>e) would be

lower bound for latest year emissions estimated [i.e. 0 Mt CO<sub>2</sub>e \* (100% - 10%)] minus the upper bound for base year estimated emissions [i.e. 1 Mt CO<sub>2</sub>e \* (100% + 10%)]

which equates to -1.1 Mt CO<sub>2</sub>e

- Using the formula described at the beginning of section A 2.4.2, the lower limit is divided by the base year mean [i.e. -1.1 Mt CO<sub>2</sub>e / 1 Mt CO<sub>2</sub>e] which results in -110% trend

## **A 2.5 SECTORAL UNCERTAINTIES**

### **A 2.5.1 Overview of the Method**

Sectoral uncertainties were calculated from the same base data used for the “by gas” analysis. The emissions and uncertainties per sector are presented in **Table A 2.5.1**. The estimates are presented in IPCC categories, which is consistent with the reporting format used within this submission to the UNFCCC, but we recommend that these estimates should only be considered as indicative.

**Table A 2.5.1 Sectoral Uncertainty Estimates**

IPCC Source Category	1990 Emissions (kt CO <sub>2</sub> e)	2021 Emissions (kt CO <sub>2</sub> e)	95% confidence interval for 2021 emissions 2.5 percentile	95% confidence interval for 2021 emissions 97.5 percentile	Uncertainty in 2021 emissions as % of emissions in category	% Trend in emissions between 1990 and 2021	Uncertainty in the trend in emissions between 1990 and 2021 as % of 1990 emissions <sup>a</sup> 2.5 percentile <sup>b</sup>	Uncertainty in the trend in emissions between 1990 and 2021 as % of 1990 emissions <sup>a</sup> 97.5 percentile
1A1a	205,265	56,239	54,578	57,920	3.0%	-73%	-75%	-70%
1A1b	17,866	11,101	9,626	12,660	13.7%	-38%	-62%	-15%
1A1c	16,419	12,745	12,485	13,046	2.2%	-22%	-37%	-7%
1A2a	3,653	1,169	1,114	1,225	4.8%	-68%	-74%	-62%
1A2b	4,371	695	660	731	5.1%	-84%	-103%	-66%
1A2c	12,331	5,093	4,831	5,358	5.2%	-59%	-67%	-51%
1A2d	4,694	1,322	1,246	1,400	5.8%	-72%	-83%	-62%
1A2e	7,885	4,110	3,897	4,327	5.2%	-48%	-55%	-41%
1A2f	6,695	2,520	2,237	2,812	11.4%	-62%	-86%	-40%
1A2g	35,986	28,728	27,394	30,060	4.6%	-20%	-28%	-12%
1A3a	1,895	906	730	1,083	19.5%	-52%	-74%	-31%
1A3b	111,756	100,592	98,854	102,376	1.8%	-10%	-12%	-8%
1A3c	1,474	1,567	1,321	1,816	15.8%	6%	-17%	29%
1A3d	7,711	4,921	4,046	5,784	17.7%	-36%	-55%	-18%
1A3e	99	131	110	152	16.2%	32%	6%	59%

IPCC Source Category	1990 Emissions (kt CO <sub>2</sub> e)	2021 Emissions (kt CO <sub>2</sub> e)	95% confidence interval for 2021 emissions 2.5 percentile	95% confidence interval for 2021 emissions 97.5 percentile	Uncertainty in 2021 emissions as % of emissions in category	% Trend in emissions between 1990 and 2021	Uncertainty in the trend in emissions between 1990 and 2021 as % of 1990 emissions <sup>a</sup> 2.5 percentile <sup>b</sup>	Uncertainty in the trend in emissions between 1990 and 2021 as % of 1990 emissions <sup>a</sup> 97.5 percentile
1A4a	28,683	19,119	18,503	19,746	3.3%	-33%	-43%	-26%
1A4b	80,540	68,554	65,854	71,311	4.0%	-15%	-20%	-10%
1A4c	5,077	5,928	4,074	7,775	31.2%	17%	-34%	63%
1A5b	5,349	1,584	1,469	1,698	7.2%	-70%	-78%	-62%
1B1	26,149	719	624	812	13.1%	-97%	-115%	-80%
1B2	18,963	7,248	5,949	9,027	21.2%	-62%	-93%	-38%
2A1	7,295	4,215	4,081	4,348	3.2%	-42%	-44%	-41%
2A2	1,329	1,092	1,037	1,147	5.0%	-18%	-28%	-8%
2A3	412	340	323	357	5.0%	-17%	-18%	-16%
2A4	1,234	428	413	444	3.7%	-65%	-70%	-61%
2B1	1,896	1,179	1,154	1,204	2.1%	-38%	-42%	-34%
2B2	3,434	28	25	31	10.2%	-99%	-189%	-45%
2B3	17,729	-	-	-	n/a	-100%	-100%	-100%
2B6	105	155	140	171	10.1%	49%	24%	73%
2B7	224	131	124	139	5.6%	-41%	-50%	-32%
2B8	4,788	1,539	1,080	2,003	30.0%	-68%	-93%	-43%
2B9	12,073	121	109	133	10.0%	-99%	-114%	-84%

IPCC Source Category	1990 Emissions (kt CO <sub>2</sub> e)	2021 Emissions (kt CO <sub>2</sub> e)	95% confidence interval for 2021 emissions 2.5 percentile	95% confidence interval for 2021 emissions 97.5 percentile	Uncertainty in 2021 emissions as % of emissions in category	% Trend in emissions between 1990 and 2021	Uncertainty in the trend in emissions between 1990 and 2021 as % of 1990 emissions <sup>a</sup> 2.5 percentile <sup>b</sup>	Uncertainty in the trend in emissions between 1990 and 2021 as % of 1990 emissions <sup>a</sup> 97.5 percentile
2B10	214	31	23	38	25.6%	-86%	-109%	-62%
2C	27,302	10,725	9,861	11,591	8.1%	-61%	-69%	-53%
2D	553	402	241	657	51.8%	-27%	-96%	34%
2E	5	19	11	29	46.1%	309%	129%	516%
2F	10	10,799	9,733	11,865	9.9%	108,084%	97,403%	118,758%
2G	1,448	1,119	701	2,021	59.0%	-23%	-80%	45%
3A	27,681	23,541	22,401	24,682	4.8%	-15%	-22%	-8%
3B	7,684	6,777	5,996	7,727	12.8%	-12%	-29%	5%
3D	13,390	11,002	9,355	13,040	16.7%	-18%	-37%	1%
3F	261	-	-	-	n/a	-100%	-100%	-100%
3G	1,020	1,178	929	1,422	20.9%	16%	-16%	47%
3H	294	253	165	373	41.1%	-14%	-70%	40%
3J	461	332	197	472	41.3%	-28%	-80%	23%
4	273	153	51	360	101.4%	-44%	-182%	58%
4A	-13,392	-17,597	-20,347	-14,866	15.6%	31%	37%	26%
4B	15,205	13,330	10,762	15,885	19.2%	-12%	-19%	-6%
4C	2,324	251	-1,008	1,519	503.6%	-89%	-104%	-75%



IPCC Source Category	1990 Emissions (kt CO <sub>2</sub> e)	2021 Emissions (kt CO <sub>2</sub> e)	95% confidence interval for 2021 emissions 2.5 percentile	95% confidence interval for 2021 emissions 97.5 percentile	Uncertainty in 2021 emissions as % of emissions in category	% Trend in emissions between 1990 and 2021	Uncertainty in the trend in emissions between 1990 and 2021 as % of 1990 emissions <sup>a</sup> 2.5 percentile <sup>b</sup>	Uncertainty in the trend in emissions between 1990 and 2021 as % of 1990 emissions <sup>a</sup> 97.5 percentile
4D	3,002	2,954	2,089	3,801	29.0%	-2%	-43%	40%
4E	5,838	4,079	2,306	5,867	43.7%	-30%	-38%	-23%
4F	-	-	-	-	n/a	n/a	n/a	n/a
4G	-2,095	-2,036	-2,347	-1,733	15.1%	-3%	3%	-8%
5A	67,521	13,736	7,963	22,150	51.6%	-80%	-144%	-35%
5B	34	2,036	1,254	3,198	47.7%	5855%	3566%	9249%
5C	1,726	431	211	903	80.2%	-75%	-177%	-18%
5D	3,157	2,861	1,662	6,099	77.5%	-9%	-43%	29%
<b>Grand Total</b>	<b>817,297</b>	<b>430,594</b>	<b>420,684</b>	<b>441,909</b>	<b>2.5%</b>	<b>-47%</b>	<b>-53%</b>	<b>-43%</b>

**Note:** Emissions in this table are taken from the Monte Carlo model output. The central estimates, according to gas, for 1990 and the latest inventory year are very similar but not identical to the emission estimates in the inventory. The Executive Summary of this NIR and the accompanying CRF tables present the agreed national GHG emissions and removals reported to the UNFCCC.

<sup>a</sup> What is specifically presented here is the 95% confidence interval for the change in emissions as a percentage of 1990 emissions; this is different to the 95% confidence interval of the percentage changes since 1990. Further detail can be found in section **A 2.4.2**.

<sup>b</sup> Note that for categories where emissions have completely or almost completely stopped being generated in the latest year (i.e. has a trend of near -100%), the 2.5 percentile for the trend might be presented as a decline of over 100%. This should not be interpreted to mean that emissions might now be negative, instead this reflects that due to uncertainty in the emission estimates, the decline in emissions might be greater than the mean estimate for the base year. The below simplified example illustrates how this might occur.

If:

- Base year emissions for a category is estimated to be 1 Mt CO<sub>2</sub>e
- Latest year emissions for a category is estimated to be 0 Mt CO<sub>2</sub>e
- Uncertainty in the base year and latest year emissions estimate is 10%

Then:

- The central estimate for the trend is -100%
- The lower limit for the trend (in Mt CO<sub>2</sub>e) would be

lower bound for latest year emissions estimated [i.e. 0 Mt CO<sub>2</sub>e \* (100% - 10%)] minus the upper bound for base year estimated emissions [i.e. 1 Mt CO<sub>2</sub>e \* (100% + 10%)]

which equates to -1.1 Mt CO<sub>2</sub>e

- Using the formula described at the beginning of section A 2.4.2, the lower limit is divided by the base year mean [i.e. -1.1 Mt CO<sub>2</sub>e / 1 Mt CO<sub>2</sub>e] which results in -110% trend

## **A 2.6 COMPARISON OF UNCERTAINTIES FROM THE ERROR PROPAGATION AND MONTE CARLO ANALYSES**

Comparing the results of the error propagation approach, and the Monte Carlo estimation of uncertainty by simulation, is a useful quality control check on the behaviour of the Monte Carlo model.

The reason that the error propagation approach is used as a reference is because the approach to the error propagation approach has been defined and checked by the IPCC, and is clearly set out in the IPCC 2000 Good Practice Guidance and the 2006 Guidelines. The UK has implemented the IPCC error propagation approach as set out in this guidance. The implementation of an uncertainty estimation by simulation cannot be prescriptive, and will depend on how the country constructs its model, and the correlations included within that model. Therefore, there is a greater likelihood of errors being introduced in the model used to estimate uncertainty by Monte Carlo simulation.

If all the distributions in the Monte Carlo model were normal, and the assumed correlations were identical, the estimated errors on the trend from the Monte Carlo model should approach those estimated by the error propagation approach if enough iterations are done. The error propagation approach assumes 100% correlation between EFs in the base and inventory year, and no correlation between sources, however in reality the nature and degree of correlation varies by source, and many distributions are not normal but heavily skewed, particularly those with very high uncertainty. These differences interact in various ways, but would be expected broadly to result in higher trend uncertainty, and lower uncertainty on the most recent year's total in the Monte Carlo uncertainty estimates compared to the error propagation approach. This comparison can be seen in **Table A 2.6.1** which shows differences in the trend uncertainty between the error propagation and Monte Carlo approaches. These differences mostly arise from the fact that the error propagation approach only uses normal distributions, cannot account for different uncertainty parameters between the 1990 and the latest inventory year, cannot account for correlations between sources, and automatically assumes a correlation between the emission factor uncertainty in 1990 and the most recent year.

The central estimates of emissions generated by the Monte Carlo model in 1990, and those in the latest inventory year, are very close. We would not expect the central estimates from the two methods to be identical, but with a very large number of iterations we would expect the difference to tend to zero. To note, the base year is 1990 for N<sub>2</sub>O, CH<sub>4</sub> and CO<sub>2</sub>, and 1995 for the F-gases.

**Table A 2.6.1 Comparison of the error propagation (Approach 1) and Monte Carlo (Approach 2) uncertainty analyses**

Method of uncertainty estimation	Central estimate (Gg CO <sub>2</sub> equivalent) <sup>b</sup> Base year	Central estimate (Gg CO <sub>2</sub> equivalent) <sup>b</sup> 2021	Uncertainty on level in 2021, 95% CI	Uncertainty on trend, 95% CI (1990 / base year to 2021) <sup>a</sup>
Error propagation	820,103	430,654	2.4%	1.6%
Monte Carlo	819,946	430,594	2.5%	5.1%

**Notes:**

CI Confidence Interval

<sup>a</sup> Calculated as half the difference between 2.5 and 97.5 percentiles, assuming a normal distribution is equal to  $\pm 1.96$  standard deviations on the central estimate.

<sup>b</sup> Net emissions, including emissions and removals from LULUCF

# ANNEX 3: Other Detailed Methodological Descriptions for Individual Source or Sink Categories

This Annex contains background information about methods used to estimate emissions in the UK GHG inventory. This information has not been incorporated in the main body of the report because of the level of detail, and because the methods used to estimate emissions cut across sectors.

This Annex provides background information on the fuels used in the UK GHG inventory, mapping between IPCC and NAEI source categories and detailed description of methods used to estimate GHG emissions, and emission factors used in those methods.

## A 3.1 ENERGY

Methods for calculating emissions within the energy sector are detailed in the method statements set out in **Chapter 3**. This Annex details the emission factors used and their source, and elaborates on references commonly used within the Energy sector. The national energy balance (and how it is used) is described in **ANNEX 4**.

### A 3.1.1 Emission factors

Emission factors used for the 2023 submission for sectors 1A and 1B can be found in the accompanying excel file: 'Energy\_background\_data\_uk\_2023.xlsx'. This can be found as one of the additional documents here: [https://naei.beis.gov.uk/reports/reports?report\\_id=1108](https://naei.beis.gov.uk/reports/reports?report_id=1108). Note that there can be a delay between the NIR being published on the NAEI website after official submission.

### A 3.1.2 Commonly used references

This section describes data sources that are used across multiple emission sources within the energy sector, and how they are used.

#### A 3.1.2.1 Baggott et al., 2004 - Carbon factors review

A review of the carbon factors used in the UK GHG inventory was carried out in 2004. The report detailing this study is available from:

[http://naei.beis.gov.uk/reports/reports?report\\_id=417](http://naei.beis.gov.uk/reports/reports?report_id=417)

This aimed to validate existing emission factors and seek new data for country specific emission factors for the UK. At the time of publication this reference provided new emission factors for:

- coal from power stations;
- fuels used in the cement industry;
- a number of petroleum based fuels;
- natural gas; and

- coke oven and blast furnace gas.

Since then following updates are made to the following emission factors based on new information:

1. Coal emission factors are adjusted based on the annual variations in the GCV of the fuels using methods developed as part of the 2004 analysis (Baggott et al., 2004).

$$EF_y = EF_{ref} / GCV_{ref} * GCV_y$$

Where

$EF_y$  is the emission factor (EF) in year y

$EF_{ref}$  is the EF in the reference year (the year for which data are available)

$GCV_{ref}$  is the GCV in the reference year

$GCV_y$  is the GCV in year y

2. Since the advent of EU ETS in 2005, a number of sources of emissions from coal which had previously been reliant on Baggott et al., 2004 have now been replaced with data from the ETS, where the data set was considered suitable (high proportion of source included, and high proportion of T3 plant specific data). In addition, in 2014 the use of oxidation factors from this report was reviewed, and where suitable background evidence to support the factors used were not available, the IPCC default (of 1, IPCC 2006) has been used.
3. Emission factors for petroleum based fuels (where ETS data are not available) are still largely based on Baggott et al., 2004. These were reviewed in 2014 and compared with the defaults in the 2006 IPCC Guidelines and found to be largely within the range of the 2006 Guidelines. No new data for the UK has been identified and the emission factors from Baggott et al., 2004 are still considered to be relevant country specific emission factors.
4. During 2017-18, a review of the UK's shipping inventory was conducted (Scarborough et al., 2018). This identified new carbon emission factors for marine fuels, which replace the factors identified as part of Baggot et al., 2004.
5. Emission factors for natural gas are updated annually based on analyses from the gas network operators (Personal Communications from network operators, 2019). As part of the systems improvements made to the inventory database in 2020 (moving from mass to energy units, and from gross to net), data from the gas operators has been further analysed and a revised gross to net conversion has been derived. This has been applied to the data from the early part of the time series, which came from Baggott et al., 2004.
6. Emission factors for coke oven gas and blast furnace gas are estimated based on a carbon balance approach (as described in Chapter 3, **MS 4**).
7. The Mineral Products Association provide data for fuels used in the cement industry annually on a confidential basis, and these are validated with EU ETS data (Personal Communication, MPA, 2021). For the 2020 submission, data received for the 2004 review was reconsidered for cement, and revised coal factors for the early part of the time series (that were not received in time for inclusion in the final review report) have now been incorporated into the inventory.

A new review of carbon emission factors was conducted during 2017, focusing on those factors retained from the 2004 review (Brown et al., 2017). This concluded that the factors that are currently in use are slightly more conservative than more recent values identified, and that there

was no new robust evidence upon which we could justify changing the current factors. There were also recommendations on which emission factors might be the highest priority for further research in future. This report is available here: [http://naei.beis.gov.uk/reports/reports?report\\_id=947](http://naei.beis.gov.uk/reports/reports?report_id=947)

### **A 3.1.2.2 The Pollution Inventory and other regulators' inventories**

The Pollution Inventory (PI) has, since 1998, provided emission data for the six Kyoto gases (NF<sub>3</sub> is not included) and other air pollutant for installations regulated by the Environment Agency (EA) in England and Natural Resources Wales (NRW) in Wales. This is part of the UK's process for managing regulated emissions from industry processes under the IPCC permitting system. The PI does contain earlier data of carbon dioxide emissions at some sites reported from 1994 onwards. The Scottish Pollutant Release Inventory (SPRI) covers processes regulated by the Scottish Environment Protection Agency (SEPA), and contains data from 2002 and 2004 onwards. The Northern Ireland Pollution Inventory (NIPI) covers processes regulated by the Northern Ireland Environment Agency and includes data for 1999 onwards.

These data are subject to some very significant limitations:

- Emissions of each pollutant are reported for each permitted installation as a whole, so emissions data for carbon dioxide, for example, can cover emissions from fuel use as well as from an industrial process. No information is given on what the source of emissions is, so a judgement has to be made about the scope of reporting;
- Permitting arrangements have changed over time, so the reporting of data is not on a consistent basis across the time-series. In general, the tendency has been to reduce the number of permits, so that whereas in the early 1990s there might have been separate permits at an industrial installation covering the boiler plant and the chemical processes, from the late 1990s onwards the tendency would be to issue a single permit to cover both. Therefore, the problems with the scope of emissions data mentioned in the first bullet point are most severe for the second half of the GHGI time series; and,
- Since 1998, process operators need only report emissions of each pollutant if those emissions exceed a reporting threshold. For example, where emissions from an installation are less than 10,000 tonnes of CO<sub>2</sub>, or 10 tonnes of methane, the operator does not need to report any emissions data for that substance in that year. Reporting thresholds are irrelevant for many of the sectors of interest to this study, since emissions would be many times higher than the thresholds, but the reporting thresholds do mean that it is necessary to consider whether the data available in the PI (and in the SPRI & NIPI for later years) will be complete.

Despite these limitations, these data are still a useful source of information for the UK GHG inventory. A considerable amount of effort is put into manually interpreting the individual returns and allocating these to appropriate categories for use in the inventory estimates by the Inventory Agency.

### **A 3.1.2.3 The Environmental and Emissions Monitoring System (EEMS) Reporting System**

Emissions from upstream oil and gas production facilities, including onshore terminals, are estimated based on operator reporting via EEMS, managed by the Offshore Petroleum Regulator for Environment and Decommissioning (OPRED) and developed in conjunction with the trade association Oil & Gas UK (formerly the UK Offshore Operators' Association, UKOOA). The EEMS data provides a detailed inventory of point source emissions estimates, based on operator returns for the years 1995-2021. However, the EEMS data for 1995 to 1997 are not complete, frequently

exhibiting duplicate entries with identical submissions by operators across years. Since the 1995 – 1997 data are not considered reliable, the EEMS dataset is only used directly to inform national inventory estimates from 1998 onwards for the following sources:

- gas flaring;
- own gas combustion;
- well testing; and
- oil loading (onshore and offshore).

*[Activity data are not routinely collected via EEMS for sources including: fugitive releases, direct process activities, oil storage or gas venting. The emissions from these sources are reported as annual estimates by operators and used directly within the inventory.]*

These EEMS-derived activity data enable detailed analysis of the oil & gas emissions and related emission factors at the installation level, providing a high degree of data transparency and enabling the Inventory Agency to perform quality checks by source, by site, by year to identify and check/resolve any potential data gaps or outliers. The EEMS data per installation are only available back to 1998. The UK inventory estimates for the 1990-1997 period are based on industry surveys and analysis that were submitted to UK Government by the trade association, UKOOA; these data are more aggregated, per source but aggregated across all installations during 1995 to 1997, and aggregated across sources for 1990-1994. The EEMS data from 1998 onwards help to inform the EFs that are combined with oil and gas sector-wide activity statistics back to 1990 in order to derive time series consistent estimates.

### **A 3.1.2.4 Fynes & Sage (1994)**

Fynes and Sage is a country-specific reference from the mid-1990s, and it includes analysis of solid fuels typically used in the UK economy in that period, deriving mass-based emission factors that are used within the UK GHGI. In the 1990s, coal used in the UK economy was predominantly mined in the UK, whereas over the time series of the inventory there has been a decline in the share of coal from UK sources and an increase in coal imports from around the world.

For recent years, for the more significant emission sources, e.g. energy industries and manufacturing industries, the Inventory Agency uses EFs that are derived from EU ETS data, but for smaller emission sources in the UK that still use solid fuels (such as residential, collieries) the Fynes and Sage data are retained, as there are no EU ETS data for fuels used in these sectors. There is some uncertainty regarding how representative the EFs from Fynes and Sage may be for these smaller combustion sources, but we note that the use of coal-fired technology in sectors such as collieries and residential is predominantly in the UK coal production areas, where local supplies are still available.

### **A 3.1.3 Feedstocks and Non-Energy Use (NEU) of fuels**

The estimation methods are described within individual sections of the NIR, but are summarised here. The general approach adopted in the UK GHG inventory is to assume that emissions from all non-energy uses of fuels are zero (i.e. the carbon is assumed to be sequestered in products such as plastics and other chemicals), except for cases where emission sources can be identified and emission estimates included in the inventory. There is one exception to this, for petroleum coke where we have no information on any non-emissive uses at all, and so we adopt the conservative approach of assuming that all petroleum coke use is emissive.



The UK Inventory Agency conducts periodic studies into the fate of fuels reported as non-energy use, in order to assess the levels of stored carbon and carbon emitted for different fuels over the time series. These detailed studies are supplemented through annual data gathering and consultation with stakeholders to maintain an accurate representation of the emitted and stored carbon in the inventory.

The assumptions and estimates for individual sources are based on a review conducted in 2013-14 (Ricardo-AEA, 2014b) which included research into UK-specific activities and data sources as well as a review of the National Inventory Reports (NIRs) of other countries.

The sections below outline the emission sources from feedstock and NEU of fuels that are included in the UK GHGI, the source data and estimation methods and a summary of the time series for each of the fuel types where there is a stored carbon component in the UK energy balance. The estimates are all presented in CRF Tables 1.Ab and 1.Ad.

**Table A 3.1.1 Summary of Emission Sources for UK Fuels Allocated as Non Energy Use in UK Energy Statistics**

Fuel	IPCC	Source Category
Light petroleum distillates and natural gas liquids <sup>5</sup>	1A1a	Scrap tyre combustion in power stations (1994 to 2000 only). Fossil carbon in MSW combustion in energy from waste plant.
	1A1b	Other petroleum gas use in refineries (2004, 2006 to 2011, 2013 to 2021 only). <i>Re-allocated from non-energy use as UK ETS and trade association data indicates that DUKES data on OPG combustion are an under-report.</i>
	1A2f	Waste solvents, waste-derived fuels containing fossil carbon, in cement kilns. Scrap tyres and waste plastics etc. combusted in cement kilns.
	1A2g	Industrial combustion of waste solvents. <i>Emissions of carbon from chemical feedstock via combustion of products such as synthetic rubbers and solvents.</i>
	2B8	Energy recovery from process off-gases in the chemical industry. <i>Large quantities of naphtha, butane, propane, ethane, and other petroleum gases are listed in DUKES as used for non-energy applications and these fuels are known to be used extensively as chemical feedstocks. However, UK ETS and operator data indicate that process off-gases, derived from the chemical feedstocks, are a major fuel for ethylene production processes and other petrochemical sites. Emissions of CO<sub>2</sub> are reported in 2B8.</i>
	5C	Fossil carbon in chemical waste incineration. Fossil carbon in MSW incineration. Fossil carbon in clinical waste incineration. Fossil carbon in small scale waste burning.
Lubricants	1A1a	Waste oil combustion in power stations.
	1A2f	Waste oil combustion in cement kilns.
	1A2g	Waste oil combustion in unclassified industry (including road-stone coating plant)
	1A3biv	Lubricant combustion in moped engines
	2D1	Lubricant oxidation in aircraft, industrial, road vehicle (except moped), marine shipping and agricultural engines.
	5C	Incineration of waste oil
Bitumen	n/a	<i>No known UK applications that lead to GHG emissions.</i>

<sup>5</sup> I.e. naphtha, Liquid Petroleum Gases (LPG), Refinery Fuel Gas (RFG) / Other Petroleum Gases (OPG), gas oil and Ethane. Including emissions of carbon from chemical feedstock via combustion of products such as synthetic rubbers and plastics.

Fuel	IPCC	Source Category
Petroleum coke	1A2f, 1A2g, 1A4b	Based on reported energy use data by specific industries within datasets such as UK ETS and also from direct dialogue with industry representatives, the Inventory Agency re-allocates a small proportion of the reported “NEU” allocation from DUKES, and reports emissions within the UK GHG inventory. This re-allocation generates emissions for the mineral processing sector (1A2f) and other industry (1A2g) and for petcoke use in the domestic sector (1A4b).
	2A4, 2B6, 2C1, 2C3, 2D3	There are non-combustion, emissive uses of petcoke in the UK through the use of petcoke-derived anodes in the metal processing industries. Emissions from these uses of petcoke are reported in 2C1 (electrode use in electric arc furnaces) and 2C3 (anode use in aluminium manufacture). Petroleum coke is also used in the minerals (2A4) and chemicals industries (2B6) leading to further emissions. The remaining consumption of petroleum coke is also assumed to be emissive, with emissions reported under 2D3.
Other Oil	2D2	Carbon released from use of petroleum waxes. Uses of petroleum waxes includes candles, with carbon emitted during use.
Coking coal (coal oils and tars)	n/a	<i>Unknown quantities of coal tar pitch are used in the manufacture of anodes for industrial processes. In the UK inventory the emissions from the use of these anodes are allocated only against petroleum coke (also used in anode production). This is a small mis-allocation of emissions between the two fuels since the carbon emitted is likely to arise from both petroleum coke and the coal tar pitch, but it is due to lack of detailed data, and does not affect the accuracy of UK inventory emissions.</i>
Natural Gas	2B1, 2B8	Ammonia and methanol production leading to direct release of CO <sub>2</sub> from natural gas used to provide the energy for steam reforming and from natural gas feedstock to the reformer. Carbon originating in the natural gas feedstock which is converted into methanol is assumed to be stored.

**A 3.1.3.1 Naphtha, Ethane, Gas Oil, Refinery/Other Fuel Gas (RFG/OPG) Propane and Butane (LPG)**

Ethane, LPG (given separately as propane & butane in the energy statistics), gas oil, refinery / other fuel gas (RFG/OPG) and naphtha are all consumed in very significant quantities for non-energy uses, primarily as feedstock in chemical manufacturing. In the UK, several major petrochemical production facilities are supplied with Natural Gas Liquid (NGL) feedstock directly from upstream production pipelines, and then utilise NGL fractions such as ethane, propane and butane in their manufacturing processes. In addition, several integrated refinery / petrochemical complexes in the UK use a proportion of the refinery fuel gas as a feedstock in petrochemical production.

The NEU allocations presented in DUKES reflect the reported disposals of these commodities as feedstocks to chemical and petrochemical companies. There are several sources of GHG emissions from this stock of “NEU” feedstock carbon, although a high proportion of carbon is stored into products and not emitted.

One large emission source known to occur in the UK is the use of carbon-containing process off-gases as a fuel within the chemical facilities. Whilst the exact source of the carbon cannot be traced directly to a specific feedstock commodity within the UK sectoral approach, the available information from UK ETS and from consultation with operators enables the Inventory Agency to derive estimates of the GHG emissions across the time series from this emission source.

The majority of emissions are from installations manufacturing ethylene, but a number of other chemical sites report additional emissions in the UK ETS that can be attributed to the combustion of process off-gases and residues derived from the chemical feedstock. As a result, the UK inventory emissions in 2B8 now include estimates of emissions from use of process off-gases and residues at 5 ethylene manufacturing installations and 17 other chemical manufacturing installations in the UK. The derivation of a time series of emission estimates from these sources is based as far as possible on reported data by plant operators within trading scheme data and other regulatory reporting mechanisms. For the early part of the time series, data on changes in plant capacity over time is used to derive the best estimates of activity and emissions by extrapolation back from later emission estimates, whilst for later years the completeness and transparency of operator reporting is greater. Therefore, whilst the uncertainty for the emission estimates in the early part of the time series is significantly greater than for those in recent years, the Inventory Agency has made best use of the available data to derive the time series estimates of emissions from “NEU” activity. Consultation with a sector trade association has also confirmed that there are no other sector estimates of this activity, or of production data across the time series, that could be used to further improve the time series (Personal communication: Chemical Industries Association, 2014).

Other emissions included within the UK GHG inventory include emissions from the destruction of chemical products, e.g. when wastes are incinerated or used as fuels. Although emissions from incineration and combustion of wastes are estimated, we cannot relate the carbon in these wastes back to individual feedstock, so it is not possible to generate reliable UK estimates of the proportion of carbon that is ultimately emitted from each individual fuel. Incineration of wastes derived from chemical feedstocks will be reported in 1A1a (in the case of plastics etc. in municipal waste incinerated with energy recovery) and in 5C (in the case of chemical, clinical and municipal wastes incinerated without energy recovery). Waste-derived fuels, including waste solvents, waste plastics and scrap tyres are used as fuels in cement kilns and other industrial plants, and emissions reported in 1A2. Tyres contain a mixture of natural and synthetic rubbers, and so where waste tyres are used as a fuel, the emission estimates take into account that only some of the carbon emitted is derived from fossil fuels.

Some propane / butane mixtures are used as a propellant in aerosols and are emitted as VOC. The UK inventory contains estimates of these VOC emissions, combined with emissions of solvents used in aerosols.

It is assumed that all gas oil used for non-energy purposes is used as a feedstock material, and consultation with DECC (now DESNZ) energy statisticians supports this (Personal communication: Will Spry, DECC Energy Statistics team, 2014). A possible alternative use would be in explosives, but consultation with the Health and Safety Executive, who regulate the UK explosives industry, has confirmed that no UK installations manufacture explosives using gas oil or fuel oil as a feedstock (HSE, 2013).

### **A 3.1.3.2 Lubricants**

Lubricants are listed separately in the UK energy statistics and are used in vehicles and in machinery. The inventory includes estimates of emissions of carbon due to oxidation of lubricants during use, and also includes estimates of emissions from the combustion of waste lubricants and other oils used as fuel.

UK GHG inventory estimates of the quantities of lubricants burnt as fuels are based on data from Recycling Advisory Unit, 1999; BLF/UKPIA/CORA, 1994; Oakdene Hollins Ltd, 2001 & ERM,

2008, as well as recent research to access information regarding the UK market for waste oils and the impact of European Directives to consolidate industrial emission regulations such as the Waste Incineration Directive (Oil Recycling Association, 2010). Estimates of waste oil combustion are derived for the following source categories:

- 1A1a Power stations;
- 1A2f Cement kilns; and
- 1A2f Other (unclassified) industry.

The estimated emissions for other industry assume that waste oils are used by two sectors: road-stone coating plant and garages. Other sectors may use waste oils as a fuel or as a reductant, but research to date provides no compelling evidence that there is a significant gap in the UK inventory for waste oil use by industrial operators.

The emission trends from power station use of waste lubricants reflect the fact that the Waste Incineration Directive (WID) had a profound impact on the market for waste oil, used as a fuel. It is assumed that no waste oil was burnt in power stations for the years 2006-2008, on the basis that the classification of waste oil as a fuel would have led to users being subject to the requirements of WID. In 2009 a Quality Protocol<sup>6</sup> was introduced that allowed compliant fuel produced from waste oils to be burned as non-waste and this has encouraged a resumption in the consumption of waste oil-derived fuels from 2009 onwards.

Carbon dioxide emission estimates for the oxidation of lubricants within vehicle engines and machinery, and the use of waste oils for energy are all based on a single carbon emission factor derived from analysis of the elemental composition of a series of UK-sourced samples of waste oil (Passant, 2004). The UK inventory adopts the IPCC Tier 1 methodology for lubricant use i.e. assuming that 20% of all lubricants are oxidized during use. This assumption is used for the various sub-categories of lubricant use (including road, rail, marine, off-road and air transport) given in DUKES.

### **A 3.1.3.3 Bitumen**

In the UK, bitumen is used only for applications where the carbon is stored. By far the most important of these is the use of bitumen in road dressings. The inventory does assume that a very small proportion of the carbon in the bitumen itself is emitted as VOC during road-stone coating but does not include any estimates of direct carbon emissions from uses of bitumen. Industry consultation in 2013 (UK Petroleum Industries Association, 2013; Refined Bitumen Association, 2013) has confirmed that there are no emissive applications of bitumen in the UK. Around 85% of bitumen is used in road paving, with the remaining proportion used almost entirely in the manufacture of weather-proofing materials.

### **A 3.1.3.4 Coal Oils and Tars**

Coal-tars and benzole are by-products of coke ovens. Consultation with the operators of coal ovens (Tata, 2013) and also the UK company that refines and processes coal tars and benzole (Koppers UK, 2013) has confirmed that all of these materials are collected, refined and processed into a range of products that are not used as fuels. The carbon within coal tars and oils are entirely used within chemical processes. In some cases, the carbon is processed into anodes used in the ferrous and non-ferrous metals industries and then used (in the UK and overseas) within emissive

---

<sup>6</sup> <https://www.gov.uk/government/publications/quality-protocol-processed-fuel-oil-pfo>

applications. The UK inventory already includes estimates of emissions from UK consumption of carbon anodes within these industries, using methods based on UK metal production statistics.

Based on the evidence from process operators, the Inventory Agency allocates all of the reported coal tars and oils to Non Energy Use, i.e. assuming that all carbon is stored and there are no GHG emissions from this source-activity. The Digest of UK Energy Statistics (BEIS, 2022) also report the use of tars and benzole entirely to Non Energy Use.

Coal-tar pitch is used in the manufacture of electrodes, together with petroleum coke and a proportion of the carbon ultimately emitted, but details of input materials are scarce; emissions of carbon from these sources are included in the inventory attributed to petroleum coke. This may introduce a small mis-allocation of emissions between petroleum coke and coal oils and tars, but does not affect the UK inventory emissions total.

### **A 3.1.3.5 Natural Gas**

Natural gas is used as a chemical feedstock for the manufacture of ammonia and formerly for methanol as well, though production of the latter ceased in 2001. Emissions occur directly as a result of a) combustion of natural gas used to power the steam reforming process that is required for manufacture of both ammonia and methanol; b) oxidation of gas in the steam reforming, producing CO<sub>2</sub> which in the case of ammonia production is not needed and is instead emitted. The emissions are reported under 2B1 for ammonia and 2B8 for methanol.

Most of the emissions from feedstock use of natural gas in ammonia production are at source, i.e. waste gases containing carbon are emitted directly from the ammonia plant. Up until 2001, some was exported to a neighbouring methanol plant and here converted into methanol, and this CO<sub>2</sub> is treated as stored. Further CO<sub>2</sub> is captured and sold for use elsewhere, for example, in carbonated drinks and this CO<sub>2</sub> is assumed all to be emitted in the UK.

### **A 3.1.3.6 Other Oil (industrial spirit, white spirit, petroleum wax, miscellaneous products)**

White Spirit and Special Boiling Point (SBP) spirits are used exclusively for non-energy applications, and are listed in CRF Table 1.A(d) within the category 'other oil'. They are used as solvents; SBP spirits are used for industrial applications where quick drying times are needed (e.g. adhesives and other coatings) while white spirit is used as a solvent for decorative paint, as a cleaning solvent and for other applications. Estimates of VOC emissions are included in the UK inventory, but no estimates are made of direct emissions of carbon from these products, as they are regarded as "not occurring".

The only emissions from this group of petroleum feedstock that are included in the UK GHG inventory are the releases of carbon from petroleum waxes which are reported under 2D2. These are accounted for in the UK inventory under the fuel category "Other Oils" in CRF Table 1Ad.

### **A 3.1.3.7 Petroleum Coke**

The evidence from industrial reporting of fuel use and from periodic surveys of fuel producers that use petroleum coke to produce domestic fuels (including smokeless fuels) indicates that the allocation of petroleum coke to combustion activities in the UK energy balance is an underestimate across all years. Therefore, the Inventory Agency generates revised estimates for all combustion activities and effectively re-allocates some of the petroleum coke reported in DUKES as non-energy use to energy-related emission sources in the UK inventory.

Within the UK inventory, petroleum coke is included for the following energy and non-energy source categories:

- 1A1a: Power station use of petroleum coke, primarily within blends with coal at a small number of UK facilities; in some years only,
- 1A1b: Refinery emissions from regeneration of catalysts;
- 1A2f: Cement industry use of petroleum coke as a fuel;
- 1A2g: Other industry use of petroleum coke as a fuel;
- 1A4b: Petroleum coke use within domestic fuels;
- 2A4: Use in brick manufacture (reported combined with other emissions e.g. from use of carbonate minerals in brickmaking);
- 2B6: Use in chemicals manufacturing;
- 2C1: Carbon emissions from electrodes used in electric arc furnaces and ladle arc furnaces and petroleum coke added to furnaces as a carbon source;
- 2C3: Carbon emissions from anode use in primary aluminium production; and
- 2D3: Petroleum coke used for non-energy applications not included elsewhere.

The UK energy balance tables in DUKES contain data on the energy use in power stations (1A1a) and refineries (1A1b), although the former are only available for 2007 onwards, and both sets of data do not always agree with the available activity data from UK ETS. The remaining energy uses in industrial combustion (1A2f, 1A2g) and the domestic sector (1A4b) are not included in DUKES. The UK Inventory Agency therefore makes independent estimates of the consumption of petroleum coke in all of these sectors.

Petroleum coke is burnt in **cement kilns** (1A2f) and has been burnt in some years at a handful of **power stations** (1A1a). A few other **large industrial sites** (1A2g) have also used the fuel. Good estimates of the consumption of petroleum coke by these large sites are available from the operators themselves, from trade associations and from UK ETS data (from 2005 onwards).

Fuel grade petroleum coke is also used as a **domestic fuel** (both smokeless and non-smokeless types, reported in 1A4b). The Inventory Agency uses data supplied by the UK fuel supply industry to estimate petroleum coke consumption for domestic fuels across the time series, from 1990 to the latest year; these estimates are broadly consistent with fuel use data published in earlier editions of DUKES for a few years in the late 1990s.

Carbon deposits build up with time on catalysts used in **refinery** processes such as catalytic cracking. These deposits need to be burnt off to regenerate the surface area of the catalyst and ensure continued effectiveness of the catalyst; emissions from this process are reported within DUKES since 1998 and UK ETS since 2005. Catalyst regeneration is treated in the inventory as use of a fuel (since heat from the process is used) and are reported under 1A1b.

Estimates of carbon released from electrodes and anodes during **metal processes** are estimated based on operator data and reported in 2C1 and 2C3. Petroleum coke content of these electrodes and anodes is estimated based on operator data and literature sources such as Best available techniques reference documents (BREF notes). UK ETS data also show that some petroleum coke is added to electric arc furnaces as a carbon source, and the emissions from this use are also reported in 2C1. UK ETS data are also used for emission estimates for brickmaking, which include a component from petroleum coke. Finally, petroleum coke is used in the manufacture of titanium dioxide, with emission estimates generated from UK ETS and other operator data.

Based on data from DUKES we believe that there is some additional non-energy use of petroleum coke for most years; we assigned this residue to 2D3 and assume that it is all eventually emitted. The total fuel assigned to sector 2 is what we report as 'excluded carbon' in the CRF, table 1A(d). The consumption estimates for industrial users of petcoke as a fuel or in industrial processes are associated with low uncertainty as they are primarily based on operator reported data within the UK ETS or other regulatory reporting mechanisms. Whilst it is conceivable that other sectors may also use petroleum coke as a fuel, there is no evidence from resources such as UK ETS and Climate Change Agreement reporting that this is the case in the UK. The remaining petroleum coke consumption given in DUKES is therefore assumed to be used in various unidentified non-energy uses, all of which are assumed to be emissive. The estimates of petroleum coke used to generate fuels for the domestic sector are associated with higher uncertainty as they are based on periodic consultation with fuel suppliers to that market, and expert judgement of stakeholders.

As well as the total UK supply figure from UK energy statistics, DUKES has data on UK production, imports and exports of petroleum coke, which together provide more information on the nature of the UK consumption of petroleum coke. These data cover three distinct types of petroleum coke – catalyst coke, produced and consumed at refineries only (so no import/export or supply of fuel to other UK sectors), and then two products made in a refinery process known as coking: fuel grade (green) coke and anode-grade coke, with the former being used as a fuel, and the latter being a calcined<sup>7</sup> version of the former, used in various non-energy processes. Consultation with the DECC (now DESNZ) energy statistics team and the only UK refinery with a coking process (DECC, 2013) has confirmed that the UK produces only anode-grade coke, and exports will also be anode-grade coke, whilst imports will be fuel grade coke for use as a cost-effective fuel source or raw material for production processes under NEU.

Carbon factors for petroleum coke use are derived from industry-specific data (including UK ETS fuel analysis) in the case of cement kilns (MPA, 2022), power stations and other industrial sites (EA, 2022; SEPA, 2022). The petroleum coke factor for refinery consumption is based on trade association analysis conducted as part of the 2004 Carbon Factors Review (UKPIA, 2004) while the factor for domestic consumption is based on compositional analysis of samples of petroleum coke sold as domestic fuels (Loader et al, 2008).

These factors do show quite a large variation from sector to sector: this is probably primarily a reflection of the different requirements of fuels for different sectors (higher quality, higher carbon for some, less so for others). The highest carbon factor is for 'petroleum coke' burnt in sector 1A1b, but this fuel is actually of a different nature from the fuel burnt as petroleum coke in sectors 1A1a, 1A2f and 1A4b. In the case of 1A1b, the fuel is a build-up of carbon on catalysts used in various refinery process units, while in the other three cases, the petroleum coke is a solid by-product of a totally different refinery process (coking) which has different characteristics.

### **A 3.1.3.8 Carbon Storage Fractions: Import-Export balance for Carbon-containing Materials**

The analysis within the UK energy statistics or GHG inventory compilation system cannot accurately account for the variable (over time) import-export balance of carbon-containing materials in the UK economy. For example, where the Inventory Agency accounts for the carbon emissions from scrap tyres burned in cement kilns, power stations, incinerators and so on within

---

<sup>7</sup> Calcined petroleum coke is a processed petroleum coke that has a very high carbon content; the resulting fuel is somewhat similar to coke oven coke



the inventory estimates or from the incineration of plastics or synthetic fibres, there is no way of tracing the quantity that is derived from imported tyres/plastics/fibres.

The reported estimate of the fate of the reported NEU of fuels from the UK energy balance is based on an assumed “closed system”, whereby we account for all emissions from carbon-containing products and fuel types that are allocated as NEU as if they are derived from the fuel statistics in the UK energy balance. In reality, the source of the carbon emitted from feedstock and NEU of fuels will partly be carbon from imported materials, with UK feedstock carbon also exported and emitted elsewhere.

### A 3.1.4 Aviation (MS 7)

**Table A 3.1.2 CAA aircraft types assigned to EMEP-EEA Emissions Inventory Guidebook aircraft types**

EMEP/EEA Aircraft Type	CAA Aircraft Types
A306	AIRBUS A300 600/600F/600ST/B4/F4
A30B	AIRBUS A300 B1/B2
A310	AIRBUS A310
A318	AIRBUS A318
A319	AIRBUS A319
A320	AIRBUS A320-100/200/200N*
A321	AIRBUS A321/200N*
A332	AIRBUS A330 200
A333	AIRBUS A330 300/800*/900*
A342	AIRBUS A340 200
A343	AIRBUS A340 300
A345	AIRBUS A340 500
A346	AIRBUS A340 600
A359	AIRBUS A350 900/1000*
A388	AIRBUS A380 800
AN12	ANTONOV AN-12
AN24	ANTONOV AN-24
AN26	ANTONOV AN-26B/32
AN72	ANTONOV AN-72/74
ATP	BAE ATP
B721	BOEING 727-100/100C
B722	BOEING 727-200/200 ADVANCED
B732	BOEING 737 200

EMEP/EEA Aircraft Type	CAA Aircraft Types
B733	BOEING 737 300
B734	BOEING 737 400
B735	BOEING 737 500
B736	BOEING 737 600
B737	BOEING 737 700/BBJ/MAX 8*/ MAX 9*
B738	BOEING 737 800
B739	BOEING 737 900/900 ER
B742	BOEING 747 200B/200C/200F
B743	BOEING 747 300/300M
B744	BOEING 747 400/400F/400M
B748	BOEING 747 8/8F/8I
B74S	BOEING 747 SP
B752	BOEING 757 200
B753	BOEING 757 300
B762	BOEING 767 200/200ER
B763	BOEING 767 300/300ER/300F
B764	BOEING 767 400ER
B772	BOEING 777 200/200ER
B773	BOEING 777 300
B77W	BOEING 777 300ER
B788	BOEING 787 8
B789	BOEING 787 9/10*
BE18	BEECHCRAFT 18/SUPER H18
BE50	BEECHCRAFT 50 TWIN BONANZA
BE55	BEECHCRAFT BARON MOD 55/58/58P
BE60	BEECHCRAFT DUKE
BE99	BEECHCRAFT 99/99A
C208	CESSNA 208 CARAVAN I
C303	CESSNA T303 CRUSADER
C340	CESSNA 340
C401	CESSNA 401/402/411/421
C404	CESSNA 404 TITAN
C414	CESSNA 414A CHANCELLOR

EMEP/EEA Aircraft Type	CAA Aircraft Types
C425	CESSNA 425 CONQUEST I
C441	CESSNA 441 CONQUEST II
C500	CESSNA 500 CITATION I
C510	CESSNA 510 CITATION MUSTANG
C525	CESSNA 525 / 525 A CITATIONJET
C550	CESSNA 550 CITATION II
C560	CESSNA 560 CITATION V
C650	CESSNA 650 CITATION III/VI/VII
C680	CESSNA 680 CITATION SOVEREIGN
C750	CESSNA 750 CITATION X
DC10	MCDONNELL-DOUGLAS DC10-10/30/40
DC3	DOUGLAS DC3 C47 DAKOTA
DC6	DOUGLAS DC6/6A/6B/6C
DHC2	DHC2 BEAVER
DHC6	DE HAVILLAND DH6 TWIN OTTER
E110	EMBRAER EMB110 BANDEIRANTE
E120	EMBRAER EMB120 BRASILIA
E121	EMBRAER EMB121 XINGU
E135	EMBRAER EMB135
E145	EMBRAER EMB145
E170	EMBRAER ERJ170 100
E175	EMBRAER ERJ170 200
E190	EMBRAER ERJ190 100
E195	EMBRAER ERJ190 200/300*
F100	FOKKER 100
F27	FOKKER F27
F28	FOKKER F28-1000/2000/3000/4000/6000
F50	FOKKER 50
F70	FOKKER 70
FA10	DASSAULT FALCON 10
FA20	DASSAULT FALCON 20/200
FA50	DASSAULT FALCON 50
FA7X	DASSAULT FALCON 7X

EMEP/EEA Aircraft Type	CAA Aircraft Types
G280	GULFSTREAM G280
GA7	GRUMMAN GA-7 COUGAR
IL18	ILYUSHIN IL18
IL62	ILYUSHIN IL62
IL76	ILYUSHIN IL76
IL86	ILYUSHIN IL86
IL96	ILYUSHIN IL96-300
L188	LOCKHEED L188 ELECTRA
L410	LET 410
LJ24	LEARJET 24/25D
LJ25	LEARJET 25B
LJ31	LEARJET 31
LJ35	LEARJET 35A/36A
LJ40	LEARJET 40/45
LJ55	LEARJET 55
LJ60	LEARJET 60
MD11	MCDONNELL-DOUGLAS MD11
MD90	MCDONNELL-DOUGLAS MD90
P68	PARTENAVIA P68B/C
PA23	PIPER PA23 AZTEC/APACHE
PA30	PIPER PA30/PA39 TWIN COMANCHE
PA31	PIPER PA31/P
PA34	PIPER PA34 SENECA II
PC12	PILATUS PC-12

\* Scaled to account for later aircraft developments

### A 3.1.5 Gas leakage

An overview of the time series of estimates of gas leakage at the point of use, together with overall gas use by economic sector and appliance type is presented in **Table A 3.1.3** below.

**Table A 3.1.3 Activity data and methane leakage estimates for Gas leakage at Point of Use, including cooking appliances, gas fires and boilers**

Source / Appliance type	Units	1990	1995	2000	2005	2010	2015	2019	2020	2021
<b>Annual Gas Use</b>										
Domestic gas fires	ktoe (net)	417	470	561	587	608	429	428	431	463
Domestic manual ignition hobs / cookers	ktoe (net)	532	479	462	448	401	414	400	415	446
Domestic auto-ignition hobs / cookers	ktoe (net)	191	171	165	160	144	148	143	149	160
Domestic auto-ignition space and water heating	ktoe (net)	22,182	24,190	27,525	28,447	29,089	22,104	21,819	22,018	23,642
Service sector catering (ovens and hobs)	ktoe (net)	538	688	697	699	636	515	535	501	515
Other service sector appliances (boilers)	ktoe (net)	5999	7680	8863	8386	7802	7316	7,383	6855	7,317
<b>Methane Leakage</b>										
Domestic cooking and gas fires	ktCH <sub>4</sub>	1.02	0.94	0.86	0.85	0.8	0.78	0.80	0.83	0.89
Domestic boilers and water heating	ktCH <sub>4</sub>	0.76	0.83	0.94	0.98	1	0.76	0.75	0.76	0.81
Service sector (all sources)	ktCH <sub>4</sub>	0.83	1.06	1.09	1.05	1	0.91	0.97	0.91	0.96

Source / Appliance type	Units	1990	1995	2000	2005	2010	2015	2019	2020	2021
Total	ktCH <sup>4</sup>	2.61	2.83	2.9	2.88	2.8	2.46	2.52	2.49	2.65

### A 3.1.6 Upstream oil and gas production (1A1cii, 1B2)

#### A 3.1.6.1 Introduction

The UK has recently completed an oil and gas sector improvement project (Thistlethwaite et al, 2022) which has led to method improvements and recalculations affecting the fuel combustion emissions, reported under 1A1cii, and the fugitive emission estimates, reported under 1B2.

The research was commissioned to improve the accuracy and completeness of the UK inventory and to make use of improved oil and gas sector data availability in recent years, such as the North Sea Transition Authority's (NSTA) new national online data repository 'Open Data', which includes field-level oil and gas production data. In addition, the 2019 Refinement to the 2006 IPCC Guidelines for National GHG Inventories ('the 2019 Refinement') includes several new or updated inventory methods for the estimation of fugitives from oil and gas production; several of these new methods have been applied in the UK GHGI as they provide the best available basis for accurate and complete UK GHGI estimates, reflecting UK circumstances.

The research comprised: (i) a review of the new and emerging datasets, (ii) a critical review of pre-existing reports and data used to inform estimates across the inventory time series, and (iii) consideration of the 2019 Refinement suite of inventory methods for fugitive emissions, including to address any reporting gaps by applying the new methods.

This NIR annex text provides an insight into the key data sources used to derive inventory estimates, a summary of the inventory methods that have been developed for use in the 2022 UK GHGI submission onwards and a summary of the recalculations arising from the project.

*For more information, please refer to the Thistlethwaite et al (2022) project report.*

#### A 3.1.6.2 Scope of Upstream Oil and Gas Source Categories in the UK Inventory

The scope of emissions from the upstream oil and gas sector in the UK comprise a wide range of emission sources that are reported within the Common Reporting Format (CRF) tables under:

- 1A1cii (fuel combustion emissions); and
- 1B2 (fugitive emissions, including from flaring and venting).

For the early part of the inventory time series (i.e.1990 to 1997) the emissions data available to inform UK inventory estimates is limited in detail due to the limited source resolution in early industry-wide reporting. Since the inception of EEMS reporting in 1998, there are annual operator emission reports per source per facility.

As a result, the ability to generate a consistent time series of emissions per source from 1990 onwards is compromised. Source-specific estimates have been derived by the Inventory Agency through the use of IPCC good practice gap-filling techniques to provide estimates back to 1990; through access to and use of new data to estimate the emission trends across 1990-1997 the oil and gas improvement project has led to improved time series consistency for many sources.

However, the assurance of time series consistency for the sector as a whole may only properly be assessed at an aggregate level (i.e. across 1A1cii and 1B2 combined).

The precise source allocation of emission estimates in the 1990-1994 period is subject to higher uncertainty than in the rest of the time series, but at an aggregate level the sector-wide estimates are based on the best available data from Government and industry and analysis indicates them to be time series consistent with data post-1997 at that aggregate level.

In developing methods for all sources in the upstream sector, there are several changes over time in data availability to address, most notably for UK energy statistics (due to changes in reporting requirements and data gathering systems managed by the UK Government over the period since 1990) and for atmospheric emissions data reporting.

### **A 3.1.6.3 UK Regulatory Landscape and Key Data Sources**

*(Also see Thistlethwaite et al (2022) project report section 2.2.)*

The UK regulatory landscape for the oil and gas exploration and production sector is complex, with financial, energy and environmental reporting obligations across a range of onshore and offshore regulators. There are separate regulations (and regulatory agencies) governing the requirements for permits to operate or perform certain activities (e.g. well drilling, production activities, flaring, venting) and company reporting of activity data (e.g. production data) and environmental emissions data. As a result, there are numerous permitting and data reporting systems in place across the sector that may provide useful data to inform inventory estimates; systems for onshore installations (well sites, terminals) often differ from those for offshore installations. Furthermore, some data reporting mechanisms provide a high degree of source resolution in annual (or more frequent) operator reporting, whilst others provide no source resolution but rather present activity and/or emissions totals per year per field or per installation.

The scope and detail of data available varies considerably across the time series, which reflects the evolution of regulations in the UK and consequent changing reporting requirements on plant operators. There are long-standing data collection and reporting systems evident for activity data, such as from UK energy statistics and from the regulations governing oil exploration and production; even these however exhibit changes in scope, completeness and resolution through time.

For example, at the end of the 1990s there was an overhaul to the reporting to oil and gas regulators regarding oil and gas production, venting and flaring, as a new system, the *Petroleum Producers Reporting System* (PPRS) was implemented from 2000 onwards, to replace systems that had previously informed the UK Government statistical annual called "*Development of the Oil and Gas Resources of the UK*", known universally as the *DTI Brown Book*, production of which ceased from 2004. Much more granular data are now available from the PPRS system than were published in the Brown Book, although analysis of aggregate data across the overlap years (2000 to 2003) between the PPRS and the Brown Book indicates a highly consistent overall scope of reporting.

Therefore, a key challenge to compile accurate and complete inventory activity and emissions estimates is to assess the scope and quality of data reported across these mechanisms and determine how best to integrate them. The UK inventory improvement project has enabled the Inventory Agency to review the data in detail, consult with key stakeholders and to identify where there are high quality data that should be prioritised for use for specific emission sources, and

where there are opportunities to use inter-comparisons (between reporting mechanisms) to validate or improve (e.g. gap-fill) inventory data.

Key regulatory and data reporting mechanisms that help to inform UK inventory estimates include:

- **Emissions Trading Schemes (UK ETS, formerly EU ETS):** Operators of upstream installations submit annual estimates of CO<sub>2</sub> emissions from combustion of fuels (i.e. fuel gas and diesel) since 2005, and from flaring since 2008. The scope of reporting includes all high emitting offshore and onshore fixed installations, and reporting is per installation (i.e. per platform, FPSO or terminal); the UK ETS scope does not include smaller sites (e.g. onshore well sites and smaller offshore platforms) where the annual combustion and flaring emissions fall below the UK ETS threshold, and it also excludes mobile installations such as drilling units. Data are subject to Third Party verification checks and the system is managed via UK regulatory agencies for onshore (i.e. EA, SEPA, NRW) and offshore (DESNZ OPRED). The UK ETS provides a large, detailed dataset that includes the mass or volume of fuel burned or flared, the NCV, carbon emission factors, oxidation factors. The monitoring and reporting methods agreed across the sector include assumptions such as that flaring efficiency is 98%; sampling and compositional analysis of fuel gas samples is required for high emitting source streams.
- **EU ETS National Allocation Plans (NAPs) for Phase I and Phase II:** The NAPs for EU ETS Phase I (combustion sources only) and Phase II (combustion and flaring) were prepared in the early 2000s in order to enable trading scheme allocations to reflect the recent historical emissions per installation. The NAPs data present installation totals of CO<sub>2</sub> emissions for 1998 to 2003, with no breakdown by source or by fuel; however, due to the different scope of the NAP I and NAP II, an assessment of the emissions from *all combustion* and from *all flaring* per installation can be calculated (i.e. flaring by difference between NAP I and NAP II). NAPs data were based on operator activity data and installation-level fuel gas sampling and analysis, to improve the accuracy compared to previous estimates where default carbon emission factors had been applied (e.g. within EEMS reporting) by some operators. Where oil or gas fields were scheduled to cease production pre-EU ETS (which began in 2005), the NAPs excluded the emission estimates from installations for those production streams, to ensure that the NAPs did not over-estimate site allocations.
- **Environmental and Emissions Monitoring System (EEMS)<sup>8</sup>:** EEMS is an emissions reporting system managed by OPRED to accommodate statutory reporting obligations such as those under PPC/IED for reporting of GHG and air quality pollutants from combustion installations above 50MWth. Scope of reporting is from offshore fixed and mobile installations (i.e. it encompasses platforms, FPSOs, mobile drilling units), and includes reporting from the smaller platforms that may fall below the UK ETS reporting threshold. Operators submit annual returns of emissions of CO<sub>2</sub>, CH<sub>4</sub>, N<sub>2</sub>O, NMVOCs, NO<sub>x</sub>, CO and SO<sub>2</sub> as well as activity data (where appropriate) in tonnes per year. Activity and emissions are reported per source, per installation, i.e. with separate estimates provided for emission sources that may occur on the installation, including: fuel combustion (fuel gas, diesel consumption), gas flaring, gas venting, well testing, fugitives, direct process sources (e.g. acid gas treatment) and from oil loading. Operators of *onshore* oil and gas facilities and terminals are not mandated to use the EEMS system but report their total emissions to the Regulator Inventories (RIs) of the onshore regulatory agencies in England, Scotland and Wales. The data in the RIs is less granular than EEMS as it is

---

<sup>8</sup> <https://www.gov.uk/guidance/oil-and-gas-eems-database>



not broken down by source (see below). Up to 2010, however, the onshore terminals did voluntarily report emission estimates per source to EEMS.

- **Pollution Prevention and Control Regulations / Industrial Emissions Directive (PPC/IED):** All onshore terminals and most other onshore facilities (e.g. Natural Gas Liquid processing plant, onshore well sites, transit terminals where crude oil and oil products are stored and transferred between vessels, terminals, refineries, other sites) report to the relevant Regulator Inventory (RI) according to their location. The onshore installations are regulated by the EA (in England), SEPA (in Scotland) and NRW (in Wales). Under the terms of PPC permits, operators submit annual emission estimates per pollutant for all emissions sources (combined) within the boundary of the permitted installation. These annual emission submissions are verified by the regulatory agencies onshore and are then published on public registers. However, for onshore facilities the resolution of emissions data *per source* is not available, with a single value for each pollutant *per facility*. The scope of pollutant reporting is as per EEMS (above), but there are pollutant reporting thresholds which limit the completeness of operator reporting, i.e. annual returns to the RIs may not provide any estimate of pollutant emissions if the operator determines that the sum of emission across all sources falls below the reporting threshold. In addition, reporting of activity data (e.g. fuel use data, production or throughout data, flaring or venting data) is not required under PPC/IED;
- **Petroleum Production Reporting System (PPRS):** The NSTA's Petroleum Production Reporting System (PPRS) collects monthly data from operators of onshore and offshore hydrocarbon production in the UK Continental Shelf (UKCS), per oil or gas field and per terminal. The PPRS data provides useful activity data for inventory purposes, such as crude oil and/or gas production per month, own gas use, venting and flaring volumes, and in some cases there are other useful parameters reported such as gas density, gas NCV. The PPRS data are not collected with environmental reporting in mind; they are the basis for DESNZ (formerly BEIS) energy statistics reporting for e.g. crude oil production, dry gas and associated gas production, Natural Gas Liquid (NGL) production, as well as statistics on gas flaring and gas venting volumes. The high level of resolution of data (to field level) and the reporting of similar units (fields or terminals) enables ready analysis of key data that can support inventory estimates; for example, the sum of production at all Offshore Tanker Loader oil fields (i.e. oil fields not connected to pipelines, and hence reliant of crude oil export via shuttle tankers) directly provides an activity dataset for the annual transfers of crude oil to shuttle tankers, and onwards to refineries and terminals. The data are available since the inception of the PPRS in 2000. Whilst the production data are aggregated and published, most of the data in the PPRS reports are not public domain and were provided to the Inventory Agency solely for the purposes of the inventory improvement research project.
- **DTI annual statistical publication "Development of Oil and Gas Resources of the United Kingdom", known historically as the DTI Brown Book:** Until 2004 the UK Department of Trade and Industry published annual statistics for the upstream oil and gas sector, which brought together statistics from upstream operators that were then rolled into the PPRS reporting system (above) from 2000 onwards. The scope of data reported in those annual publications is similar to the data that can now be derived from the PPRS system, and similarly it underpins the long-term oil and gas production time series that are included in the Digest of UK Energy Statistics (DUKES). Whilst the PPRS data are more granular (e.g. monthly data), for the overlapping years (2000-2003) there is close consistency, even at the field-level aggregate annual production data. The Inventory Agency reviewed the DTI Brown Book information across 1990-2003, which includes more detail and qualitative information used to establish material flow mapping from oil/gas fields to platforms/FPSOs and then onto specific oil and/or gas terminals. This is critical information to enable the development of the field to installation to terminal mapping that

is needed to aggregate and compare field-level Brown Book/PPRS data against reported activity and emissions data. As a result, the inventory has been able to perform cross-comparisons to help identify where there may be data gaps or double-counts, and to build a more detailed understanding of production and emissions sources across the UKCS. For example, the Brown Book notes where an installation offshore is not connected to a gas export line, which we then expect to see in the emissions datasets as a high flaring site.

- **Digest of UK Energy Statistics (DUKES):** DUKES is one of the primary input datasets to the UK GHGI and the Inventory Agency consulted extensively with energy statistics leads for the upstream oil and gas sector during the oil and gas improvement project. The main points requiring clarification were the relationship between the “clean, final” data that are presented in DUKES and the upstream data inputs from systems such as the PPRS. DUKES includes numerous data time series that are ultimately derived from the upstream datasets outlined above, including data on UK crude oil production, gas production, and on the energy consumption across the sector, which is (in most years) limited to data entries for “oil and gas extraction” for two fuels: natural gas and gas oil. In addition, DUKES presents data such as GCVs and NCVs for “natural gas produced” as well as for “natural gas consumed” (i.e. in downstream sectors). There are some data gaps evident within DUKES for some of the historic data, which all previous UK GHGI submissions have also sought to address, the most significant being an under-report in fuel gas activity data presented in DUKES up to the inception of PPRS in 2000. The oil and gas improvement project has provided an opportunity to revisit the estimates for actual fuel gas use, based on analysis of other datasets and testing of the trends reported in different reporting mechanisms.
- **UKOOA 2005 oil and gas sector data submission:** The EEMS reporting system (see above) was developed from an emissions reporting system developed during the 1990s by the UK Offshore Operators Association (UKOOA) in conjunction with the offshore regulator (now OPRED) and managed by a team of consultants that conducted company surveys, data gathering and generated a database of emission estimates. This dataset from 1995 onwards was able to generate source-specific estimates for the sector, in a format closely comparable to the subsequent format of EEMS. Data for 1990-1994 were estimated and reported to UK Government based on industry surveys in 1990 and 1991, together with an analysis of the production trends across all years. Subsequently the industry conducted further analysis of key emission sources, such as to derive more accurate carbon emission factors per installation, through the process to develop the National Allocation Plans (see above) to underpin allocations per installation for the EU ETS. The 1990-2003 dataset (originally based on the early industry surveys, 1990-1994, the 1995-1997 data, and then the first few years of EEMS reporting, 1998-2003) were re-analysed to reflect the improvements in industry knowledge, and reported to UK Government in 2005. The UKOOA 2005 data submission has been used in part to inform previous UK GHG inventory estimates, primarily to inform some of the fugitive source estimates. The oil and gas improvement project has enabled a re-analysis of the data alongside the other datasets that are now available for the early part of the time series. Together with the time series (sector wide and per installation) of oil and/or gas production, and well drilling activity data, the Inventory Agency has used the UKOOA 2005 dataset and IPCC good practice methods to derive estimates per source for the sector back to 1990.
- **NSTA Well Data records, Well Operations Notification System (WONS):** The North Sea Transition Authority (NSTA), established in 2016, is the regulator responsible for managing the UK’s well consent system for the oil and gas exploration sector. The NSTA

manages the data records<sup>9</sup> from well drilling activity (from well spudding, to testing, completions) and well status (e.g. when wells are suspended or abandoned by operators). The Inventory Agency consulted with the NSTA throughout the improvement project in order to access data held in the transactional databases used to manage the consent process, but it was not possible to develop suitable queries to extract useful annual data from these resources. This may become possible in future, however the existing online data resources for well drilling activity provides a good indication of the level of exploration activity on the UKCS across the time series, with data on numbers of wells drilled per year.

### **A 3.1.6.4 Oil and Gas sector data pre-processing**

(Also see *Thistlethwaite et al (2022) project report section 3.1.*)

The raw data from the reporting systems outlined above requires pre-processing in order to derive a dataset in a suitable format and with data labels added to enable (i) data from parallel reporting mechanisms to be compared per installation, and (ii) the inventory calculations to be performed. The pre-processing of the raw data includes:

- Aggregation and labelling of data from multiple years of reporting to develop a dataset in a consistent format, with data labels added to facilitate subsequent data processing within inventory models (e.g. spreadsheets, databases, coded models). Data labels include: year of activity / emission, unit of activity / emission, and numeric identifiers to represent the installation or emission source / activity / pollutant.
- Initial data consistency checking and ‘cleansing’ to identify and correct data gaps and/or outliers that may affect the accuracy of subsequent calculations, e.g. to apply range checks on input data to identify where a parameter (e.g. fuel gas density, NCV) has been reported at the wrong order of magnitude.
- Initial data validation checks and enhancements, for example to conduct time series consistency checks through cross-comparison with other datasets, and to derive other useful parameters for use in inventory methods, e.g. unit conversions / other data transformations to derive weighted-average parameters across a source/sector to apply in inventory methods.

The sections below describe the key raw data pre-processing steps and checks that the Inventory Agency has conducted to generate data for input into the source-specific inventory methods.

### **Field to Installation Mapping**

NSTA data (on oil and gas production, own gas use, flaring and venting) is gathered in the monthly operator returns within the PPRS; these data are gathered *per individual oil or gas field*, i.e. at the level of each individual geological formation that has been developed for production.

All of the environmental data reporting, through EEMS or UK ETS, is at the level of the top-side installation, i.e. *per oil or gas platform, mobile drilling unit or FPSO*.

Both types of dataset exhibit data quality problems (or potential problems) such as data reporting gaps and outliers, and both the *production / activity* and *emissions* datasets have notable step-changes in data availability across the time series. Inter-comparison of the NSTA/PPRS and EEMS or UK ETS datasets enables gaps and outliers to be checked, corrected where necessary, and uncertainties minimised. To do this, the Inventory Agency researched documentation (e.g. DTI Brown Book section “*Review of Fields in Production and Under Development*”) and online information to develop a mapping to link each geological oil or gas field to the platform or FPSO that receives and processes the oil and gas. In many cases the mapping is a 1-1 relationship with

---

<sup>9</sup> [www.nstauthority.co.uk/data-centre/data-downloads-and-publications/well-data](http://www.nstauthority.co.uk/data-centre/data-downloads-and-publications/well-data)

low uncertainty. In cases where there was some uncertainty in the mapping, e.g. fields that may export to several installations, the Inventory Agency shared the mapping table with the NSTA to seek clarifications and corrections.

This pre-processing step enables text (such as names of fields and installations) to be linked to numeric values for simpler data processing in databases and other models. The process of developing this mapping has also significantly enhanced the information resources available to the UK GHG inventory team, as the research has led to development of a resource of information to aid the understanding of the pipeline networks, outlier oil platforms/FPSOs that are not linked to gas export pipelines (and hence are likely to conduct more gas flaring), and those OTLs where oil loading emissions are expected to be reported within EEMS.

### **Installation-level Data Labelling**

Similar to the item above, the management of data from numerous reporting systems for a given installation requires the development of a series of translation tables that enable links to be made and calculations performed to compare and/or integrate data from those multiple data sources, to derive “the best” emission estimates per installation per source to minimise inventory uncertainty.

Over time, the upstream installations may be opened / closed / mothballed, they may be sold to a new operator, have a change of name, a change of permit reference, they may re-locate (e.g. FPSOs may service one area of production and then be re-deployed to a new area), or they may be divested (one site sold and split into several smaller parts, with different operators and permits) or merged. Furthermore, underpinning regulations and guidance to operators evolves over time and hence the consistency of data reported year to year may change.

All of these potential changes to raw data provision may lead to difficulties for inventory compilers in accurately tracking emissions from a consistent scope of emission sources per installation over time. Hence for each installation, clear labelling of input data sources is needed, to provide the requisite references and audit trail for the input data, and to allow querying of the data to check for potential changes in scope.

To enable the data tracking, comparisons and (ultimately) the appropriate use of the data in inventory calculations, the Inventory Agency has developed a series of data translation tables to document the data sources and enable the linkages and comparisons to be performed within inventory calculations.

The development of these data translation tables and detailed enquiry of reported data from across the time series has helped to identify numerous errors and inconsistencies in the data used in previous inventory submissions. For example, it has led to revisions in some site allocations between reporting under “oil production” or “gas production” IPCC source categories, leading to (in general) equal and opposite recalculations between the oil and gas sectors.

Through the research and consultation with industry, the Inventory Agency has also reviewed and updated the scope of installations that are “upstream” oil and gas sites, including the identification and removal of some double counts with downstream or other industrial sites. For example, one LNG terminal and one power plant (previously considered part of an adjacent terminal) were included within the scope of upstream estimates in previous submissions, and also the associated fuel use and emissions were included in other inventory sectors (i.e. 1A1ci and 1A2gviii in those two examples).

### **Activity and Emissions Data Pre-Processing**

**UK ETS:** The reported CO<sub>2</sub> emissions (and underlying AD and EFs) from the UK ETS are from a very limited sub-set of inventory (mostly *key*) source categories, comprising:

- Upstream oil production; Upstream gas production

- Fuel combustion: Fuel gas or Diesel
- Gas flaring

The allocation of the UK ETS data to flaring, fuel gas combustion or diesel combustion is then conducted manually by the Inventory Agency, through review of the reported parameters (activity data, emission factors, oxidation factors, NCVs) and the accompanying text descriptions provided by operators:

- An oxidation factor (OF) of 98% is used for flaring<sup>10</sup>; an OF of 100% is used for combustion;
- Diesel use is identified through returns indicating *source type* “combustion: commercial standard fuels”, *source stream description* “Gas/diesel oil” or “Diesel”, and a CO<sub>2</sub> EF for diesel;
- Fuel gas is identified through returns indicating *source type* “combustion: other gaseous and liquid fuels”, *source stream description* may be wide range of names but typically includes “fuel gas” or “export gas”. The activity data, emission factors and NCVs show a wider range of variability, with typically EFs in the range ~2.5 to 2.8 tCO<sub>2</sub> per tonne

The Inventory Agency has access to detailed UK ETS (formerly EU ETS) data available from 2013 onwards (i.e. Phase III of EU ETS) and for some earlier years back to 2005, and hence there is a relatively large, detailed dataset and the emission sources and fuel types / qualities per installation show good time series consistency. For some earlier EU ETS years the Inventory Agency does not have access to fully detailed data (i.e. information per source, per fuel, including EFs, NCVs) but does have the (public domain) EU Transaction Log emission totals per installation, and EEMS reporting for offshore installations which does present data split between combustion and flaring sources also.

**EEMS:** A similar, but simpler, data allocation process as applied for the UK ETS data is conducted for the EEMS data reporting, in order to align the reported data to installation codes and to UK inventory source categories and fuels / activities. The EEMS data reporting documentation assigns each line of data to one emission source from a defined list of sources, together with the operator name, facility name and type (fixed or mobile). The annual emissions data and activity data (“Total use”) are all presented in mass units (tonnes). The EEMS emission sources are used in the inventory for both upstream *oil* or *gas* installations, and include:

- **Gas consumption:** in either turbines, engines or heaters, each with different default EFs per pollutant. Scope of pollutants: CO<sub>2</sub>, NO<sub>x</sub>, N<sub>2</sub>O, SO<sub>2</sub>, CO, CH<sub>4</sub>, NMVOC.
- **Diesel consumption:** Scope and resolution of data reported is the same as for gas consumption. Notably a high proportion of the diesel use is reported as used in engines within mobile drilling units.
- **Fuel Oil consumption:** Scope and resolution of data reported is the same as for gas consumption. Reporting of fuel oil use is limited to a small number of sites and years.
- **Gas flaring:** Scope of pollutants: CO<sub>2</sub>, NO<sub>x</sub>, N<sub>2</sub>O, SO<sub>2</sub>, CO, CH<sub>4</sub>, NMVOC. Sub-categorisations of flaring (e.g. *gross, routine operations, maintenance, upsets/other*) are used by some operators but does not appear to be reported consistently.
- **Gas venting:** Scope of pollutants is typically: CO<sub>2</sub>, CH<sub>4</sub>, NMVOC. As with flaring, sub-categorisations of venting (e.g. *gross, maintenance, operational, emergency*) are used by some operators but does not appear to be reported consistently.

---

<sup>10</sup> Shaw et al., 2022. Through the analysis of emission plumes in the North Sea between 2018 and 2019, it was found that 98.4% of carbon in flared gas is converted to CO<sub>2</sub>

- **Well testing:** Reported under either *Emission Category Oil* or *Gas*, defining whether the well being drilled was for oil or gas exploration. Scope of pollutants: CO<sub>2</sub>, NO<sub>x</sub>, N<sub>2</sub>O, SO<sub>2</sub>, CO, CH<sub>4</sub>, NMVOC. The EEMS operator guidance indicates that the emissions are primarily due to the flaring of gases as the liquid and gaseous materials eluted from a well test are separated, with the liquids collected for disposal.
- **Fugitive emissions:** Scope of pollutants: CO<sub>2</sub>, CH<sub>4</sub>, NMVOC. The vast majority of reported fugitives are described (sub-source) as gross, but in some cases more details are provided of the precise source (e.g. valves, connectors, open-ended pipes).
- **Direct process:** Scope of pollutants: CO<sub>2</sub>, NO<sub>x</sub>, N<sub>2</sub>O, SO<sub>2</sub>, CO, CH<sub>4</sub>, NMVOC. Many of the direct process entries have further information provided to clarify the source, which are typically: sour gas vent, thermal oxidiser, acid gas treatment, amine regeneration, incinerator.
- **Oil loading:** Scope of pollutants: CH<sub>4</sub>, NMVOC. Analysis of the time series of EEMS data shows that the reporting of this source is inconsistent with many sites only reporting the source intermittently. This source is only reported by OTLs, and not by upstream gas producers nor oil sites connected to pipelines.
- **Storage tanks:** Scope of pollutants: CH<sub>4</sub>, NMVOC. This source was used in the earlier years of EEMS reporting by the terminal operators. Since 2010 when reporting to EEMS was deemed not to be a mandatory requirement for terminal operators (as they also report to the RIs), this source is not reported consistently in EEMS.

The EEMS data as received from the OPRED team are compiled into a multi-year table holding all historic EEMS data, i.e. from 1998 onwards. These data are then quality checked, e.g. time series checks to identify gaps and outliers in AD and EFs, compared against the UK ETS data (for flaring and combustion sources) and applied within the inventory source category calculations.

**National Allocation Plans (NAP):** During the oil and gas improvement project, the Inventory Agency analysed the UK's National Allocation Plan for Phases I and II of the EU ETS and compared them against the original EEMS data submissions, to assure and/or improve the accuracy of the data for the upstream sector in the 1998-2003 period. Further information about this process and its effect can be found in 2022 submission of the UK GHGI Annual Report<sup>11</sup>.

**PPRS:** Since 2000, operators have submitted monthly data returns from individual oil and gas fields, and from oil, dry gas and associated gas terminals; these data are useful to inform or quality check inventory estimates. The PPRS data are confidential and have not been made available previously for use in the UK inventory development. The Inventory Agency is now granted annual access to the data and reviews in detail to identify opportunities to improve inventory estimates.

The monthly reports are available for defined unit types (*terminals*: oil, dry gas, associated gas; *fields*: oil, gas, offshore loaders, onshore loaders), with a consistent scope of data fields reported by each operator per unit type. The Inventory Agency has critically reviewed the data across the time series, to check for time series consistency, look at data reporting gaps per terminal or oil or gas fields, and assess how best to use PPRS data to improve the accuracy and completeness of the UK inventory.

We note that these PPRS data underpin the UK energy statistics for the sector, with quality checks and data gap-filling conducted by the DESNZ energy statistics team. The oil and gas improvement project has afforded a useful parallel analysis of the data; in many cases the Inventory Agency has been able to reproduce the data that is published in DUKES and hence understand more

---

<sup>11</sup> [https://naei.beis.gov.uk/reports/reports?report\\_id=1072](https://naei.beis.gov.uk/reports/reports?report_id=1072)

completely the processing that is conducted and the scope of data that is used to inform energy statistics, including not only the annual fuel use totals but also useful other parameters such as fuel calorific values and densities.

Deviations from UK energy statistics based on the analysis from PPRS are detailed in the inventory methodology sections, including for: (i) total upstream oil and gas fuel gas use, (ii) fuel gas NCVs, and (iii) oil loading activity data from Offshore Tanker Loaders (OTLs).

The analysis of the PPRS datasets per unit type implemented numerous data checks (e.g. time series consistency, outlier identification, internal consistency checks such as mass balance on material flows through the terminals), gap-filling and aggregation of data to compare against other datasets, such as the industry summary data presented in DUKES or other DESNZ statistical outputs. This detailed “deep dive” analysis enabled the Inventory Agency to assess the overall data quality per PPRS report, and to better understand the scope and potential usefulness of the different monthly returns, the parameters reported and the expected internal consistencies for each PPRS report. Once lessons had been learned and (for example) acceptable ranges of parameters identified, more automated approaches were developed to conduct data cleansing of the raw data, identifying data gaps or outliers, and applying assumptions to derive a revised, more complete and internally consistent dataset for subsequent use in inventory methods.

The PPRS data provide a detailed insight into the variable quality of the products and the eluted gases at each site, which in turn reflect the variability of the geological formations across the different areas in the UKCS and the changes over time as production trends have shifted across the many individual oil and gas fields. The PPRS data that have been used in the inventory methods are:

- Time series of field, installation and sector-wide crude oil and natural gas production data, used primarily as a proxy dataset to address reporting gaps, i.e. to help identify where emissions data may be missing from EEMS, and in some cases estimating emissions in a missing year using production trends as the proxy to indicate activity and emission trends;
- Time series of fuel gas density and calorific values, derived for the different types of installation and fuel gas, to reflect whether the origin of the fuel gas was a dry gas field / installation / terminal, or associated gas from an oil field / installation / terminal.
- Time series of production from Offshore Tanker Loaders (OTLs) to underpin the oil loading fugitive emissions from transfers of crude oil to shuttle tankers, for transport to shore.

The tables below present the fuel quality data that have been derived from PPRS, EU ETS and EEMS data across the time series, including the CO<sub>2</sub> EF per TJ (net), NCV and density of fuel gas in four sub-sectors: offshore oil installations, offshore gas installations, oil terminals and gas terminals. The variable fuel gas composition across the different sub-sectors of the industry is based on the annual weighted averages of operator-reported data from each UK installation and reflects the different composition of the untreated fuel gases that are encountered at the different stages of upstream oil and gas production.

**Table A 3.1.4 UK Upstream Fuel Gas Carbon Dioxide EF per Source, 1990-2021**

Installation	Units	1990	1991	1992	1993	1994	1995	1996	1997	1998	1999
Oil field	tCO <sub>2</sub> /TJnet	64.5	64.5	64.5	64.5	64.5	65.1	64.8	66.4	65.3	64.1
Gas field	tCO <sub>2</sub> /TJnet	59.0	59.0	59.0	59.0	59.0	59.5	59.3	60.7	60.0	58.2
Oil terminal	tCO <sub>2</sub> /TJnet	65.7	65.7	65.7	65.7	65.7	63.4	64.1	67.3	67.6	66.7
Gas terminal	tCO <sub>2</sub> /TJnet	58.6	58.6	58.6	58.6	58.6	56.5	57.1	60.0	59.7	58.5

Installation	Units	2000	2001	2002	2003	2004	2005	2006	2007	2008	2009
Oil field	tCO <sub>2</sub> /TJnet	64.2	63.4	63.8	64.4	64.1	63.1	62.9	63.6	63.4	64.0
Gas field	tCO <sub>2</sub> /TJnet	58.6	58.3	57.4	58.1	58.1	59.0	58.1	58.1	58.0	57.2
Oil terminal	tCO <sub>2</sub> /TJnet	66.6	68.8	67.5	67.8	67.4	67.4	67.3	67.2	64.4	65.2
Gas terminal	tCO <sub>2</sub> /TJnet	57.6	57.4	57.3	57.6	56.8	57.0	56.5	58.8	57.6	57.5

Installation	Units	2010	2011	2012	2013	2014	2015	2016	2017	2018	2019
Oil field	tCO <sub>2</sub> /TJnet	63.2	65.4	64.0	62.9	65.3	64.5	63.9	63.7	64.1	63.0
Gas field	tCO <sub>2</sub> /TJnet	57.5	58.2	60.4	62.0	58.3	59.1	59.3	57.4	58.3	58.5
Oil terminal	tCO <sub>2</sub> /TJnet	67.2	70.2	68.7	66.5	68.3	67.9	66.9	67.3	67.3	66.5
Gas terminal	tCO <sub>2</sub> /TJnet	57.2	57.8	59.4	57.6	57.1	57.2	57.5	57.9	58.1	57.3

Installation	Units	2020	2021
Oil field	tCO <sub>2</sub> /TJnet	63.0	61.4
Gas field	tCO <sub>2</sub> /TJnet	59.0	59.9
Oil terminal	tCO <sub>2</sub> /TJnet	66.3	66.2
Gas terminal	tCO <sub>2</sub> /TJnet	56.2	57.0



**Table A 3.1.5 UK Upstream Fuel Gas Net Calorific Value per Source, 1990-2021**

Installation	Units	1990	1991	1992	1993	1994	1995	1996	1997	1998	1999
Oil field	GJ/tonne	41.7	41.7	41.7	41.7	41.7	41.7	41.7	41.7	41.7	41.7
Gas field	GJ/tonne	45.7	45.7	45.7	45.7	45.7	45.7	45.7	45.7	45.7	45.7
Oil terminal	GJ/tonne	41.7	41.7	41.7	41.7	41.7	41.7	41.7	41.7	41.7	41.7
Gas terminal	GJ/tonne	46.1	46.1	46.1	46.1	46.1	46.1	46.1	46.1	46.1	46.1

Installation	Units	2000	2001	2002	2003	2004	2005	2006	2007	2008	2009
Oil field	GJ/tonne	41.7	42.1	41.5	41.3	41.5	41.7	41.7	41.5	41.7	41.5
Gas field	GJ/tonne	45.7	46.1	45.8	45.8	46.0	45.1	45.6	45.4	45.2	46.0
Oil terminal	GJ/tonne	41.7	42.1	41.5	41.3	41.5	41.7	41.7	41.5	41.7	41.5
Gas terminal	GJ/tonne	46.1	46.8	46.2	45.9	46.1	45.5	46.1	46.3	45.9	46.2

Installation	Units	2010	2011	2012	2013	2014	2015	2016	2017	2018	2019
Oil field	GJ/tonne	41.9	40.6	41.2	41.8	40.8	41.0	41.7	41.6	41.4	41.9
Gas field	GJ/tonne	46.2	45.6	44.2	45.6	45.8	45.3	45.2	46.4	45.8	45.5
Oil terminal	GJ/tonne	41.9	40.6	41.2	41.8	40.8	41.0	41.7	41.6	41.4	41.9
Gas terminal	GJ/tonne	46.4	45.9	44.7	46.0	46.2	46.3	46.5	46.4	45.7	46.0

Installation	Units	2020	2021
Oil field	GJ/tonne	42.1	42.1
Gas field	GJ/tonne	45.2	45.3
Oil terminal	GJ/tonne	42.1	42.1
Gas terminal	GJ/tonne	46.2	46.2

**Table A 3.1.6 UK Upstream Fuel Gas Density per Source, 1990-2021**

Installation	Units	1990	1991	1992	1993	1994	1995	1996	1997	1998	1999
Oil field	kg/sm <sup>3</sup>	0.86	0.86	0.86	0.86	0.86	0.86	0.86	0.86	0.86	0.86
Gas field	kg/sm <sup>3</sup>	0.76	0.76	0.76	0.76	0.76	0.76	0.76	0.76	0.76	0.76
Oil terminal	kg/sm <sup>3</sup>	0.86	0.86	0.86	0.86	0.86	0.86	0.86	0.86	0.86	0.86
Gas terminal	kg/sm <sup>3</sup>	0.76	0.76	0.76	0.76	0.76	0.76	0.76	0.76	0.76	0.76

Installation	Units	2000	2001	2002	2003	2004	2005	2006	2007	2008	2009
Oil field	kg/sm <sup>3</sup>	0.86	0.86	0.86	0.86	0.85	0.86	0.85	0.86	0.85	0.85
Gas field	kg/sm <sup>3</sup>	0.76	0.75	0.76	0.76	0.75	0.77	0.76	0.75	0.76	0.75
Oil terminal	kg/sm <sup>3</sup>	0.86	0.86	0.86	0.86	0.85	0.86	0.85	0.86	0.85	0.85
Gas terminal	kg/sm <sup>3</sup>	0.76	0.75	0.76	0.76	0.75	0.77	0.76	0.75	0.76	0.75

Installation	Units	2010	2011	2012	2013	2014	2015	2016	2017	2018	2019
Oil field	kg/sm <sup>3</sup>	0.84	0.86	0.85	0.85	0.86	0.85	0.85	0.84	0.85	0.85
Gas field	kg/sm <sup>3</sup>	0.75	0.76	0.78	0.76	0.75	0.76	0.75	0.75	0.75	0.76
Oil terminal	kg/sm <sup>3</sup>	0.84	0.86	0.85	0.85	0.86	0.85	0.85	0.84	0.85	0.85
Gas terminal	kg/sm <sup>3</sup>	0.75	0.76	0.78	0.76	0.75	0.76	0.75	0.75	0.75	0.76

Installation	Units	2020	2021
Oil field	kg/sm <sup>3</sup>	0.85	0.85
Gas field	kg/sm <sup>3</sup>	0.76	0.76
Oil terminal	kg/sm <sup>3</sup>	0.85	0.85
Gas terminal	kg/sm <sup>3</sup>	0.76	0.76

**PPRS vs DTI Brown Book Data:** Once the PPRS data quality checking and cleansing was completed, the Inventory Agency conducted further data quality checks focusing on the time series consistency of field-level oil and (dry or associated) gas production data between the 1990-2003 datasets from the DTI Brown Book compared against the 2000 onwards PPRS data. This comparison indicated that the overlap years of 2000-2003 show very close consistency for all crude oil production data, not only at the overall level (as summarised below), but also for each individual field. The close comparability of the overlapping years in the two datasets gives a high level of confidence that the data reported across the time series from the two data sources are on a consistent basis and scope. There are larger differences evident of around 1-2% for the gas production data, but no systematic difference and an average difference of only 0.8% across the four years, again indicating that there are no step-changes in the scope of gas production data from the two sources.

**UKOOA 2005 submission to UK Government:** The oil and gas improvement project afforded the Inventory Agency the time and resources to evaluate the UK Offshore Operators' Association (UKOOA). For each emission source, the Inventory Agency has (i) assessed the data quality in the UKOOA 2005 dataset against the EEMS and NAPs data for the "overlap" years of 1998 to 2003, to identify any key outliers or step changes in the data, and (ii) developed a time series per inventory emission source back to 1990 using the best available data and applying IPCC good

practice gap-filling methods. Further information about this process can be found in 2022 submission of the UK GHGI Annual Report<sup>12</sup>.

## **A 3.1.6.5 Oil and Gas sector methods under 1B2**

Method statement 18 presents an overview of the data sources and methods developed and applied in the UK GHGI for upstream oil and gas sector fugitive source categories that are reported in 1B2. This annex presents additional details per source category. For all sources, the individual assessment of uncertainties (as presented in Thistlethwaite et al, 2022) have been used to inform the uncertainty parameters per category, per gas, as presented in Annex A2.3.

### **1B2a1: Oil Exploration; 1B2b1: Gas Exploration**

#### **Emission Sources**

- Offshore oil well testing
- Onshore conventional oil well exploration
- Offshore gas well testing
- Onshore unconventional gas well exploration

The initial phases of exploration for oil and gas resources lead to fugitive emissions of GHGs; these sources occur prior to production, including prospecting, exploratory well drilling, well testing, completion, field and well development.

In the UK the main emission source is in the well testing phase offshore, where wells are drilled and tested to assess the available resources, the field depth, pressure and so on to assess the feasibility of extracting the oil or gas. During the well tests, the produced fluids are separated, water and oil collected, and the gases are flared. These activities may be conducted directly from existing platforms, or from Mobile Drilling Units (MODUs), and all UK operators report their well testing emission estimates to EEMS. The 2019 Refinement (Energy Volume, Fugitives Chapter page 4.48) notes that there are no EFs for offshore well drilling / exploration activities and that these emissions “*are thought to be negligible*”; we interpret this to mean that the fugitive leaks from the initial phases of well drilling may be assumed to be negligible and/or dissolve in the water column.

There are a small number of onshore oil wells in the UK; there are limited emissions data reported by operators within the IED/PPC regulatory inventories as often the level of annual emissions of GHGs from these well sites fall below the reporting threshold. The NSTA Well Operations Notification System (WONS) includes reports on annual well drilling activity, and these data can be used to derive GHG emission estimates from the exploration phase, using the method set out in the 2019 Refinement.

In 2021 BEIS commissioned a separate study to estimate GHG emissions from unconventional gas well drilling. Very minor emissions of methane are reported in 1B2b1 from the exploratory drilling conducted in the UK during 2010 to 2019, however there was no subsequent gas production.

#### **Pollutants Reported**

- Carbon dioxide, methane, nitrous oxide, oxides of nitrogen, carbon monoxide, sulphur dioxide, NMVOCs, particulate matter

#### **Method Summary**

---

<sup>12</sup> [https://naei.beis.gov.uk/reports/reports?report\\_id=1072](https://naei.beis.gov.uk/reports/reports?report_id=1072)

## Onshore oil well exploration

- IPCC 2019 Refinement Tier 1 method:  $Emission = AD \times Default\ EF$
- Activity data: Number of conventional oil wells drilled per year. These data on wells drilled onshore area available across the time series:
  - 1990 to 1993: DTI Brown Book 2001, Appendix 4;
  - 1994 to 1999 data from DTI Brown Book 2004; and
  - 2000 onwards from the NSTA Well Operations Notification System (WONS)<sup>13</sup> annual reports on drilling activity
- Emission Factor(s): Default (D) EFs from IPCC, mass of pollutant emitted per conventional oil well drilled: *IPCC Refinement 2019 Table 4.2.4: Tier 1 EFs for Oil Exploration*.

## Offshore Oil Well Testing and Offshore Gas Well testing

- UK industry Tier 2/3 method, utilising the facility-level EEMS data for 1998 onwards, the industry-wide sector estimates for 1995 to 1997 (UKOOA 2005) and an estimate of well testing activity for 1990-1994 through extrapolation back from 1995 using well drilling statistics. The EEMS dataset specifies if the well test was for oil or gas.
- The EEMS data (BEIS, 2022a) present the AD in tonnes (of gases flared) and the emissions of individual gases including: CO<sub>2</sub>, CH<sub>4</sub>, N<sub>2</sub>O, NO<sub>x</sub>, NMVOC, CO, SO<sub>2</sub>.
- UK GHGI emissions =  $\sum$  operator emissions data per pollutant
- EFs for each pollutant are derived:  $EF = \sum \text{operator emissions} / \sum \text{activity data}$

## Onshore Unconventional Gas Well Exploration

- UK GHGI emissions =  $\sum$  operator emissions data per pollutant
- Information obtained direct from the regulatory agency, the EA, for each of the 12 well sites spudded during 2011-2019; none of these wells have gone into production.

## **Method Assumptions and Observations**

- There is no unconventional oil exploration and production in the UK. The method applied to the onshore conventional oil sector is taken from the 2019 Refinement and addresses a minor gap in UK regulatory reporting, as the well operators onshore seldom exceed the reporting threshold for IED/PPC reporting during the exploration phase. There is a small risk of a minor double-count if for some of the larger well sites the operators have included some well drilling/exploration emission estimates in their annual submissions to regulators (which are used in the method outlined below for onshore oil production emissions).
- Well testing emission estimates on an installation-specific basis are included within the EEMS datasets from 1998 onwards at all sites of offshore exploration activities within UK's territorial waters, including data on both activity and emission factors of excess gas that is flared or released to the atmosphere. Emissions released at the seabed are not included in estimates; it is assumed that any such releases will dissolve in the water column without subsequent release to the atmosphere.
- In the EEMS dataset there is no separate reporting of emissions from well drilling, completions and testing; it is assumed that any releases of gases at the seabed during drilling or completions will dissolve in the water column, whereas any fugitive releases on the rigs are reported within EEMS. The Inventory Agency has consulted with the Coordinating Lead Author of the 2019 IPCC Refinement, Energy Fugitives, and national expert in oil and gas emissions inventory reporting, and confirmed that there are no default

---

<sup>13</sup> [www.nstauthority.co.uk/data-centre/data-downloads-and-publications/well-data](http://www.nstauthority.co.uk/data-centre/data-downloads-and-publications/well-data)

data to estimate well drilling and completion emissions in offshore production; therefore, the UK inventory estimates are considered to be accurate as they based on the best available operator-reported data, complete and consistent with the IPCC Guidelines.

- **Completeness:** In the UK there are no known omissions. The addition of estimates for onshore oil well exploration address a minor gap in previous UK submissions. There is a risk that operators offshore may not report their oil or gas well testing activity to EEMS; mobile drilling units by their nature are deployed across different production regions of the world and hence they may appear and disappear from the EEMS reporting year to year, which makes it difficult to evaluate the completeness of EEMS over the time series. However, we have no evidence that under-reporting occurs. The UK inventory includes estimates from drilling activities at unconventional gas sites during 2010-2019, which total <60 tCH<sub>4</sub> in any one year; see Method Statement 18 for details.
- **Accuracy:** The onshore oil production method is Tier 1, applying default EFs from the 2019 IPCC Refinement which are associated with high uncertainty (cited as -12.5% to +800%). It is a minor source in the UK context and hence does not impact significantly on overall inventory uncertainty. The oil and gas well testing EFs that operators typically apply in their EEMS returns are taken from operator guidance that was last updated for this source in 2008, based on UK industry research. There is some uncertainty that the carbon emission factors from that research are representative of the carbon content of the eluted gases from all oil and gas wells across the UKCS, given the range in crude oil, associated gas and dry gas compositional analysis that is noted from different installations reporting from different production areas on the UKCS. However, the data are UK-specific EFs, derived from analysis of fluids from UKCS production historically.
- **Time Series Consistency:** The underlying data (well drilling numbers) for the onshore oil exploration source is time series consistent. The offshore oil and gas well testing reporting by operators has been to a consistent reporting mechanism since ~1995. The 1990-1994 data are extrapolated using IPCC good practice methods, i.e. proxy data on well drilling to deliver a time series consistent dataset as far as is practicable.

### Scope for future research and improvement

- To conduct drilling activities, offshore operators are required to report to NSTA under the Energy Act / Petroleum Act, request drilling consents, submit data to the NSTA WONS portal and also apply for Consent to Locate to a given oil or gas field. Through analysis of information on Consent to Locate and PETS EIA directions, it may be feasible to check on the completeness of reporting to EEMS by MODUs, i.e. to ensure that all operating MODUs have reported to EEMS, and to gap-fill where needed. However, operators are only required to obtain an NSTA flaring consent and an EIA Direction for *extended* well tests (i.e. well tests scheduled to run for longer than 96 hours) and not for standard well tests and hence there may not be a complete list from NSTA to use to validate the completeness of EEMS.
- The EFs applied in the EEMS system for oil and gas well testing have not been reviewed by the industry for >10 years; they may or may not be accurate and representative for the well testing practices and drilling activities in new production areas of the UKCS in recent years. To improve accuracy and ensure that the UK estimates are based on current EFs, new research and/or monitoring would need to be conducted.

### Uncertainties

- The uncertainty parameters applied at category-gas level are presented in Annex 2.3.
- As noted above, the EFs applied for onshore oil exploration are associated with high uncertainty; the 2019 Refinement cites a range of -12.5% to +800% of the stated EF.

- The oil and gas well testing EFs are based on UK industry research from ~15 years ago. The GHG emissions are dominated by CO<sub>2</sub>, which is closely linked to the carbon content of the flared gases. Based on many years of EEMS and EU ETS reporting of combustion of gas from the UKCS, the gas content can vary considerably, but the overall average CEF does not. The well testing EFs uncertainty is therefore estimated to be quite low, at ±10%.

**1B2a2: Oil Production & Upgrading****Emission Sources**

- Offshore oil production: Direct Processes
- Offshore oil production: Other fugitives
- Oil terminals: Direct processes
- Oil terminals: Other fugitives
- Onshore conventional oil production

These emission sources cover the release of fugitive gases from the processing units on upstream facilities, where the produced fluids are extracted, treated (e.g. to remove acid gases), separated to allow the onwards delivery or use of liquids (crude oil, condensate) and gases. The emissions arise from leaks on the platform / FPSO / terminal infrastructure, from pipes, flanges, connectors, compressors, dehydrators, separators and other units. In the UK the reporting of fugitive releases by operators tends to fall into two categories: (i) several installations report “direct process” emissions that are usually due to the treatment of acid gases which are processed or flared / incinerated leading (usually) to additional releases of CO<sub>2</sub> and other gases such as SO<sub>2</sub> (e.g. Tartan Alpha, Piper Bravo, Kinneil Terminal); and (ii) all offshore facilities and oil terminals report operational fugitive releases from leaking infrastructure, which are usually estimated based on an inventory of all of the equipment on the facility (i.e. counts of flanges, pipelines, connectors, compressors and so on) and UK industry EFs (from EEMS) on leaks per year per piece of equipment.

Onshore oil production sites also exhibit similar fugitive releases but for most sites the level of annual emissions is below the reporting threshold for IED/PPD regulatory inventories, and hence an alternative method is needed to address that reporting gap.

**Pollutants Reported**

- Carbon dioxide, methane, nitrous oxide, oxides of nitrogen, carbon monoxide, sulphur dioxide, NMVOCs

**Method Summary**Onshore oil production

- For CH<sub>4</sub> and NMVOC, a hybrid method that uses UK operator data where they are reported and gap-filling for sites that do not report. For CO<sub>2</sub> and N<sub>2</sub>O there is no operator reporting of any emissions data and hence an IPCC Tier 1 method is applied:  $Emission = AD \times Default\ EF$
- Activity data: Over the time series there are 47 oil well sites active, and for each we have an annual volume of crude oil produced from industry reporting to NSTA and its predecessors:
  - 1990 to 2003: DTI Brown Book 2004;
  - 2004 onwards from the PPRS system of monthly reporting.
- Emission Factor(s): For the larger sites, such as Wytch Farm, Scampton North, Singleton and Cold Hanworth, there are operator reported estimates of CH<sub>4</sub> and NMVOC available from the PI, and these are used directly. For the remaining sites, CH<sub>4</sub> and NMVOC estimates are gap-filled using their reported production data and the weighted-average EF from the sites reporting to the PI, i.e. derived by dividing the sum of reported emissions by the sum of production at sites that reported emissions. This is effectively a Tier 2 method, applying UK-specific EFs.

For CO<sub>2</sub> and N<sub>2</sub>O, for all sites the method uses the IPCC default EFs from the 2019 Refinement for sites with high emitting technologies and practices; this EF is selected on

the basis that whilst there is a regulatory system in place in the UK, these are small producing sites where implementing mitigation techniques are unlikely to be economic to apply. We further note that these are very small producers and the impact on the UK GHGI totals of the choice of default EF is almost negligible; if they were significant emitters they would report to the PI/SPRI.

#### Offshore Oil Direct Processes and Fugitives

- UK industry Tier 2/3 method, utilising the facility-level EEMS data for 1998 onwards, the industry-wide sector estimates for 1995 to 1997 (UKOOA 2005) and an estimate of direct process and fugitive emissions for 1990-1994 through extrapolation back from 1995 using crude oil production statistics. A small number of installations account for the direct process sources and in those cases the time series of their estimated annual oil production or throughput was used to estimate the process emissions.
- The EEMS data (BEIS, 2022a) present the AD in tonnes (of all gases released) and the emissions of individual gases including: CO<sub>2</sub>, CH<sub>4</sub>, N<sub>2</sub>O, NO<sub>x</sub>, NMVOC, CO, SO<sub>2</sub>. Emissions of fugitives (rather than direct process emissions) are dominated by CH<sub>4</sub> and NMVOC, with some reporting of CO<sub>2</sub> also evident.
- UK GHGI emissions =  $\sum$  operator emissions data per pollutant

#### Oil Terminal Direct Processes and Fugitives

- The method is as described for offshore units above, i.e. a UK industry Tier 2/3 method, utilising the facility-level EEMS data for 1998 to 2010 (when most terminals ceased reporting to EEMS), the industry-wide sector estimates for 1995 to 1997 (UKOOA 2005) and an estimate of direct process and fugitive emissions for 1990-1994 through extrapolation back from 1995 using crude oil production statistics.
- For onshore terminals, the annual submissions to the PI/SPRI are verified by the regulatory agency, whereas EEMS data are not. Therefore, to align the inventory totals to these verified data, across all years where PI/SPRI > EEMS totals per pollutant, the inventory method allocates the residual emissions to this source category. Further, for 2011 onwards, where the *only* data reported are from the PI/SPRI, the inventory method across all sources aligns to the total reported to the PI/SPRI and estimates of direct process and fugitive emissions are modelled based on previously reported source estimates and the trend in annual emissions per pollutant, per installations.
- This source category is also used for residual emissions once all other source estimates have been made, for the 1990-1997 dataset. The UKOOA 2005 dataset provides source-specific estimates back to 1995, and the 1990-1994 estimates per source are modelled (see other method descriptions across 1A1cii and 1B2) using proxy data. CO<sub>2</sub> and N<sub>2</sub>O arise primarily from fuel combustion and gas flaring. For methane and NMVOC, the allocation of emissions across a range of sources is especially uncertain for 1990-1994; it is unknown whether the reported emissions from industry were from process sources, fugitive leaks, material storage or from venting. Our approach is to estimate specific allocations of methane and NMVOC from direct processes, storage and venting, and allocate the rest to “other fugitives” and report them here.

#### **Method Assumptions and Observations**

- For process and fugitive sources where the EEMS emissions data are provided without any underlying AD and EF information, the UK inventory method is to aggregate those operator-reported data and conduct QC against other reported data (such as production data to identify when installations start and cease production) to ensure completeness.
- Fugitive emissions reported within EEMS are typically aggregated for each installation, without any further information on the specific source/unit. Similarly, emissions reported



under IED/PPC to the PI/SPRI by terminal operators are aggregated across all sources on the defined installation. These national circumstances of data availability mean that the UK inventory data cannot be disaggregated to separate fugitive emissions from oil and gas processing units, from other fugitives, such as acid gas removal units (except where these are specifically identified as “direct process” sources), other connectors, flanges and pipeline infrastructure. The transparency of the underlying operator calculations is limited, and QC of the data focuses on time series consistency per installation.

- The time series of estimates is heavily influenced by reported data from a relatively small number of installations. As noted in the method overview, a number of sites have additional processing requirements due to, for example, the incidence of acid gases from the upstream oil fields. The UK GHGI trend is therefore influenced significantly by the production trends at those installations. As with all sources, there is greater uncertainty regarding the estimates at the start of the time series due to the limited data resolution in the UKOOA 2005 dataset, but IPCC good practice gap-filling techniques have been used to deliver a plausible time series per source.
- The CH<sub>4</sub> and NMVOC method for onshore oil well sites uses operator reported emissions for larger sites and then applies an assumption that the smaller non-reporting sites operate at a similar EF of emissions per unit production.

## **Scope for future research and improvement**

- The method is reliant on the operator reporting to EEMS; in order to test against an IPCC default or other methodology (such as the fugitives methodology developed through research in Norway in recent years) would require significant investment to gathering more detailed data about the infrastructure on UK platforms, FPSOs and terminals. To develop a more comprehensive Tier 2 method would require UK regulators and industry to generate more detailed activity and emissions data through either annual submissions or periodic research.
- For terminals there is an opportunity to update the requirements within IED/PPC permits (e.g. in response to the latest BREF notes) to include additional operator reporting (annual or periodic) of source-specific estimates, to supplement the installation-wide emission estimates that are currently reported to the PI/SPRI. Additional data (including AD or contextual info on e.g. production) would provide transparency of the source-specific emissions, and remove the need for assumptions to be applied to estimate the allocation of total emissions across fugitives, venting, storage, combustion etc, improving accuracy and opportunities to conduct QC.

## **Uncertainties**

- The uncertainty parameters applied at category-gas level are presented in Annex 2.3.
- The EFs applied for onshore oil production are associated with high uncertainty; the 2019 Refinement indicates that CO<sub>2</sub> EF uncertainties are around  $\pm 30\%$ , whilst the range for N<sub>2</sub>O is -10% to +1000%.
- In the latest year and considering the relative contributions to emission estimates per pollutant and the underlying methods and EFs, our expert judgement is that the activity data uncertainty is around 5 to 10% and the EF uncertainties are around 30% for CO<sub>2</sub>, 50% for CH<sub>4</sub> and 200% for N<sub>2</sub>O.

## **1B2a3: Oil Transport**

### **Emission Sources**

- Offshore oil loading

- Onshore oil loading
- Oil transport fugitives: pipeline (onshore)
- Oil transport fugitives: road and rail tankers

The transfer of oil from the upstream production installations to refineries and terminals leads to fugitive emissions of hydrocarbons due to venting and leakage from pipelines, marine tankers, rail and road tankers. In the UK, these emissions arise from:

- (i) crude oil production and offshore loading from OTLs to shuttle tankers;
- (ii) off-loading of crude oil from oil tankers to onshore terminals and refineries;
- (iii) transfer of crude oil via pipelines from offshore platforms and FPSOs to onshore terminals;
- (iv) onshore loading of crude oil to road or rail tankers at onshore well sites; and
- (v) the subsequent oil unloading from road/rail tankers at onshore terminals.

Under the IED/PPC reporting scope for onshore terminals, the items (ii), (v) and the onshore pipeline component of (iii) are already accounted for, and further any fugitives from the offshore end of oil pipelines under (iii) are covered within the scope of operator reporting of fugitive releases to EEMS.

The 2019 Refinement presents new guidance and EFs (Table 4.2.4B) for pipeline transfers, and two sets of EFs for shuttle tanker ships to account for those operating abatement equipment (“VRU”) and those that do not. These EFs are based on Norwegian research; information from the industry indicates that North Sea shuttle tankers operate across the UK and Norwegian Continental Shelf production area, and hence the 2019 IPCC Refinement EFs are regarded as representative of UK circumstances.

Loading emissions are influenced by many contributing factors including: the composition and temperature of the crude oil; the design and operation of the loading system; whether the vessel cargo tanks contain HC gases, inert gases or a mixture of these when the loading operation starts; and (for offshore loading) the wave heights and weather conditions during loading.

## **Pollutants Reported**

- Methane, NMVOC and carbon dioxide

## **Method Summary**

### Offshore Oil Loading

- IPCC 2019 Refinement Tier 1 method:  $Emission = AD \times Default\ EF$
- Activity data: Over the time series there are 33 offshore installations that service the crude oil from oil fields that are OTLs, and for each we can derive an annual volume of crude oil produced across the time series, from industry reports to NSTA and DTI, and the field-installation mapping:
  - 1990 to 2003: DTI Brown Book. [1990-1994, BB 1995 Annex 6; 1995-1997, BB 2000 Appendix 9; 1998-2000, BB 2001 Appendix 9; 2001 to 2003, BB 2004 Appendix 9.]
  - 2004 onwards from the PPRS system of monthly reporting per field, aggregated across all fields and months per installation.
- Emission Factor(s): Default (D) EFs from IPCC. EF units are mass of pollutant emitted per 1000m<sup>3</sup> of oil produced: *IPCC Refinement 2019 Table 4.2.4B: Tier 1 EFs for Oil Transport*.
  - Shuttle tankers (no VRU): 0.065 t CH<sub>4</sub> /1000 m<sup>3</sup>; 1.10 t NMVOC /1000 m<sup>3</sup>

### Onshore Oil Loading

- UK industry Tier 2/3 method, utilising the facility-level EEMS data for 1998 to 2010 (when most terminals ceased reporting to EEMS), the industry-wide sector estimates for 1995 to 1997 (UKOOA 2005) and an estimate of onshore oil loading emissions for 1990-1994 through extrapolation back from 1995 using crude oil production statistics.
- The EEMS data (BEIS, 2022a) present the AD in tonnes of crude oil received from shuttle tankers at the terminal and the emissions of individual gases in tonnes, including: CH<sub>4</sub> and NMVOC.
- UK GHGI emissions =  $\sum$  operator emissions per pollutant
- For 2011 onwards, where installations continued to report to EEMS (e.g. Nigg, Flotta reported to 2014) then these data are used. For other sites where the only data reported are from the Pollution Inventory (PI) or the Scottish Pollutant Release Inventory (SPRI), there is no source resolution of reported emissions, only a total per pollutant per year per site is reported. The inventory method across all sources aligns to the total reported to the PI/SPRI and an estimate of oil loading emissions has been modelled based on previously reported source estimates and site total. These estimates have been augmented through operator consultation, for example with the ConocoPhillips Seal Sands oil terminal environmental manager (ConocoPhillips, 2019. Personal Communication) who provided a breakdown of total reported NMVOC emissions.

### Oil transport fugitives: pipeline (onshore)

- IPCC 2019 Refinement Tier 1 method:  $Emission = AD \times Default\ EF$
- Activity data: There is only one onshore production site where the level of annual production warrants the investment in a pipeline to a nearby terminal, and that is the 91 km 16" diameter pipeline from Wytch Farm to Hamble terminal, via Fawley refinery. The annual production of crude oil at Wytch Farm is published via the historic DTI Brown Book, and now via the PPRS:
  - 1990 to 2003: DTI Brown Book. [1990-1992, BB 1995 Annex 6; 1993-1994, BB 2008 Annex 6; 1995-1997, BB 2000 Appendix 9; 1998-2000, BB 2001 Appendix 9; 2001 to 2003, BB 2004 Appendix 9.]
  - 2004 onwards from the PPRS, through annual aggregation of monthly reported data.
- Emission Factor(s): Default (D) EFs from IPCC. EF units are mass of pollutant emitted per 1000m<sup>3</sup> of oil transported by pipeline: *IPCC Refinement 2019 Table 4.2.4B: Tier 1 EFs for Oil Transport*.
  - 0.0054 t CH<sub>4</sub> /1000 m<sup>3</sup>; 0.00049 t CO<sub>2</sub> /1000 m<sup>3</sup>; 0.054 t NMVOC /1000 m<sup>3</sup>

### Oil transport fugitives: road and rail tankers (onshore)

- IPCC 2019 Refinement Tier 1 method:  $Emission = AD \times Default\ EF$
- Activity data: The annual production of crude oil at all onshore well-sites is published via the historic DTI Brown Book, and now via the PPRS. The AD here is the total for all onshore fields less that for Wytch Farm, where the product is transferred via pipeline (see above):
  - 1990 to 2003: DTI Brown Book. [1990-1992, BB 1995 Annex 6; 1993-1994, BB 2008 Annex 6; 1995-1997, BB 2000 Appendix 9; 1998-2000, BB 2001 Appendix 9; 2001 to 2003, BB 2004 Appendix 9.]
  - 2004 onwards from the PPRS, through annual aggregation of monthly reported data.
- Emission Factor(s): Default (D) EFs from IPCC. EF units are mass of pollutant emitted per 1000m<sup>3</sup> of oil transported by pipeline: *IPCC Refinement 2019 Table 4.2.4B: Tier 1 EFs for Oil Transport*.

- 0.025 t CH<sub>4</sub> /1000 m<sup>3</sup>; 0.0023 t CO<sub>2</sub> /1000 m<sup>3</sup>; 0.25 t NMVOC /1000 m<sup>3</sup>

#### Method Assumptions and Observations

- Offshore loading of crude oil is a key source category for NMVOCs in the UK inventory, and therefore a higher-Tier approach has been sought. We note that operators do report emission estimates from oil loading at offshore assets in EEMS, but that the data show significant inter-annual variability in scope with some installations only reporting periodically and other known Offshore Tanker Loaders (OTLs) not reporting at all, indicating that EEMS data for this source are not complete. In the absence of reliable operator-reported emissions, PPRS activity data has been used along with the IPCC 2019 Refinement emission factor that assumes no abatement equipment (such as a VRU) is used on shuttle tankers while they are loaded.
- The activity data required for estimates of emissions of hydrocarbons from oil loading offshore is the annual mass of crude oil production at UKCS platforms or FPSOs that are not connected to oil pipelines and hence the crude oil is transported to shore using shuttle tankers. The operator reporting in EEMS includes activity data for the mass of crude oil transferred per year. However, the NSTA PPRS data for OTLs provides an alternative dataset via the monthly returns per OTL field on crude oil production which can be aggregated to the installation (i.e. platform or FPSO) level using the field to installation mapping. We note that the PPRS data are underpinned by statutory reporting obligations whilst EEMS is a voluntary reporting system for the oil loading source. As noted above, comparison of EEMS against PPRS and subsequent consultation with operators via the OPRED team confirmed that the EEMS-reported data by offshore operators are incomplete.
- Another alternative dataset is presented within DUKES Table F.1 *Crude Oil and Natural Gas Liquids production*, which reports an aggregated time series of mass (in kt) of crude oil production at OTLs per year. The DUKES data is derived from the NSTA PPRS data and shows close consistency in most recent years. However, the DUKES data is derived based on a calculation method that considers disposals and stock changes month to month within the tankers; our analysis indicates that in most years this provides very similar estimates to a direct aggregation of the reported mass of production per month per OTL field in PPRS. For several years in the 2000s however, the DUKES Table F.1 indicates a much lower level of OTL production when compared against the aggregate of crude oil production data in the PPRS dataset; comparison of the PPRS vs. DUKES data at the field and installation level, shared with the BEIS (now DESNZ) energy statistics team, shows that production at three BP oil fields West of Shetland are significantly under-reported in the DUKES time series. Hence to deviate from the UK energy statistics in these mid-time-series years to use the higher PPRS data is justified and was agreed with BEIS; this is important to ensure that the 2005 Base Year for NMVOC reporting is accurate.
- The outcome of this analysis indicates that the **PPRS activity data are the most complete** and accurate dataset for the UK inventory method, rather than the EEMS or DUKES Table F.1 data. For the data back to 1990, we have the Brown Book production data per field, and we have identified which oil fields are OTLs and can hence derive an aggregate total; the overlap years (2000-2003) between the Brown Book and the PPRS show very close consistency and hence we are confident that the UK inventory method has a **time series consistent** activity data time series, using the Brown Book and PPRS data together from 1990 to latest year.
- The scope of reporting of fugitive emissions at offshore installations addresses any leaks at the offshore end of oil pipelines, whilst leaks under-sea we assume to be dissolved in the water column and any leaks at the onshore terminal receiving end of the pipelines will be reported under the scope of PPC/IED annual returns. Hence, we do not consider that the 2019 Refinement method for fugitive emissions from oil transport via pipelines is

appropriate for the UK GHGI as it would introduce a double-count. We note that there is a risk that applying the pipelines method to the onshore production at Wytch Farm may introduce a small double count where fugitive leaks occur at Wytch Farm or at Hamble terminal and are already included within their annual reported emissions to the PI; however, the pipeline is on land rather than under-sea and hence any leaks at connections, compressors on the route are otherwise a gap in the UK GHGI. Hence the estimates are likely conservative but address a minor completeness issue.

- Across all of these transport fugitive sources, there is scarce data from UK sources to inform a country-specific EF; further, the many parameters that influence actual emissions (e.g. sea and weather conditions) make the accurate characterisation of this emission source highly uncertain. For the offshore loading source, there is the EEMS 2008 operator guidance which presents EFs that are derived from research in the UK in the 1990s; however we note that the 2019 Refinement EFs are derived primarily from research in the North Sea production area by the Norwegian authorities. The fleet of shuttle tankers that service the Norwegian sector also service UK installations and hence we consider that the 2019 Refinement EFs are the more recent data, based on circumstances similar to the UK and hence are the best available option.
- In deriving the offshore loading OTL activity data, we note that the crude oil production in the UK share of the median-line oil field, Statfjord, is processed and exported from a platform in Norwegian waters, and hence we have omitted the Statfjord production data in the UK GHGI activity data across the time series, as the emissions arise in Norwegian waters.
- The method described above is the recommended approach to derive both CH<sub>4</sub> and NMVOC emissions from these emission sources, but we note that to apply the new methods for NMVOCs is a decision for Defra.
- The onshore loading emissions dataset from EEMS for the small number of UK oil terminals shows clear step-changes in the NMVOC EFs applied by individual operators, which reflect the deployment of mitigation at each site over the years. Step-changes down are notable for NMVOC from: Kinneil Terminal (2003-4); Sullom Voe (2008-9); Flotta (2010-11); Seal Sands (2009-10). The default EFs in EEMS are hence not representative for onshore loading at oil terminals, where more stringent controls are now in place, due to the risk to local receptors of high NMVOC emissions at terminal ports and oil storage tank farms.

### **Scope for future research and improvement**

- There is scope for UK research into the EFs applied for all sources in this section of the industry. We note that, for example, in the update of onshore facility permits to operate under PPC/IED that the onshore regulators (EA and SEPA) have the opportunity to request that plant operators provide further insight into the source-specific estimates of pollutants within the boundary of the defined installation. This would be especially helpful to improve the evidence base for the origin of fugitive NMVOC and CH<sub>4</sub> emissions, not only for oil loading but across all sources. This type of data is likely to be gathered already by operators; however, we note that there are a range of measurement options available to operators to estimate fugitive hydrocarbons, and a standard method applied across all UK installations would be needed to generate a more accurate and comprehensive dataset.

### **Uncertainties**

- The uncertainty parameters applied at category-gas level are presented in Annex 2.3.

- As noted above, the EFs are associated with high uncertainty; the 2019 Refinement cites a range of  $\pm 100\%$  of the EFs for CH<sub>4</sub> and CO<sub>2</sub> from oil transport by pipelines, and -50% to +200% for NMVOC. The uncertainty range for oil transport by road and rail tankers is similar with a range of  $\pm 50\%$  of the EFs for CH<sub>4</sub> and CO<sub>2</sub> and -50% to +200% for NMVOC. For offshore oil loading to shuttle tankers with or without VRUs the uncertainty range for CH<sub>4</sub> is cited as  $\pm 50\%$ ; no data are provided for NMVOC for that source.
- Noting the IPCC default uncertainty ranges above and the data limitations as regards no source-specific data reported by onshore terminal operators, our expert judgement is that overall the uncertainties for this group of sources is  $\pm 50\%$  for methane, which is the only significant GHG emission, and similar for other gases.

**1B2a4: Refining / Storage; 1B2b4: Natural Gas Transmission and Storage****Emission Sources**

- Oil terminal storage
- Gas terminal storage

The storage of oil in onshore terminal tank farms leads to relatively low releases of hydrocarbons as the tanks breathe and minor fugitive releases occur. In the UK the regulation of NMVOC emissions in particular has led to mitigation of such sources through closed-loop tank filling and storage systems, floating roofs and so on. There are similar, even less significant, fugitive emission sources for hydrocarbons from storage of fluids at many UK gas terminals, which also lead to NMVOC emissions and very low releases of CH<sub>4</sub>.

Emissions from oil and gas terminals are reported under the scope of IED/PPC annual returns to UK regulators (EA and SEPA), but as with other sources there are no source-specific estimates available.

*[The methods for downstream sources such as fugitives from refining of mineral oil or from gas transmission networks are reported in the NIR Energy Chapter, Method Statement 19.]*

**Pollutants Reported**

- Methane, NMVOC

**Method Summary**Oil Terminal Storage and Gas Terminal Storage

- Tier 2/3 method, utilising the facility-level EEMS data for 1998 to 2010 (when most terminals ceased reporting to EEMS), the industry-wide sector estimates for 1995 to 1997 (UKOOA 2005). Estimates of oil terminal storage emissions for 1990-1994 are derived through extrapolation back from 1995 using crude oil production statistics; a similar method is used to estimate gas terminal storage using gas production statistics as a proxy.
- The EEMS data (BEIS, 2022a) present the AD in tonnes of fluids stored at the oil or gas terminal and the emissions of individual gases in tonnes, including: CH<sub>4</sub> and NMVOC.
- UK GHGI emissions =  $\sum$  operator emissions per pollutant
- For 2011 onwards where the only data reported are to the PI/SPRI, there is no source resolution of reported emissions; only a total per pollutant per year per oil or gas terminal is reported. The inventory method across all sources aligns to the total reported to the PI/SPRI and an estimate of storage emissions has been modelled based on previously reported source estimates and the trend in annual site emission totals.
- Oil terminals that report storage emissions in EEMS include: Flotta, Sullom Voe, Nigg, Kinneil, Seal Sands.
- Gas terminals that report storage emissions in EEMS include: Barrow North, Theddlethorpe, Dimlington, Easington.

**Method Assumptions and Observations**

- There is a very limited dataset to inform estimates from these minor sources across both oil and gas terminals, but the historic EEMS data do consistently show that total emissions of CH<sub>4</sub> are almost negligible; NMVOC emissions are slightly more significant.

**Scope for future research and improvement**

- There is scope for UK research into the EFs applied for all sources in this section of the industry, but we note that given the relative insignificance of these sources that this is not a priority for improvement in future.

### **Uncertainties**

- The uncertainty parameters applied at category-gas level are presented in Annex 2.3.
- Noting the data limitations as regards no source-specific data reported by onshore terminal operators, our expert judgement is that overall, the uncertainty for this source is  $\pm 50\%$  for CH<sub>4</sub> and NMVOC. These sources are very low emitters; hence in the context of uncertainties across the upstream oil and gas sector they are immaterial.



**1B2a6: Additional/Other Oil Fugitives****Emission Sources**

- Abandoned Oil Wells (onshore)
- Abandoned Oil Wells (offshore)

**Pollutants Reported**

- Methane

**Method Summary**

- IPCC 2019 Refinement Tier 1 method:  $\text{Emission} = \text{AD} \times \text{Default EF}$
- Activity data: Number of wells abandoned per year (cumulative), derived from the NSTA public wellbore search facility, at: <https://www.nstauthority.co.uk/data-centre/data-downloads-and-publications/well-data>
- Emission Factor(s): Default (D) EFs from IPCC. EF units are mass of pollutant emitted per well abandoned per year. IPCC Refinement 2019 provides Tier 1 emissions factors for plugged, unplugged and both types for onshore and offshore oil wells.

**Method Assumptions and Observations**

- That each well, once abandoned, continues to emit low levels of hydrocarbons in each subsequent year, and that the IPCC default EFs are representative of UK circumstances.
- Over the history of onshore oil and gas production in the UK, there has been an evolution of post-operational practices as regulation has increased; older wells are unlikely to have been capped, whereas more recently all wells abandoned are required to be capped to minimise risk of hydrocarbon leakage.
- The NSTA has not been able to provide analysis of the wells dataset to present the specific information on the year in which each well was abandoned. The NSTA well status is listed according to when the well was drilled. Therefore, we have assumed, given the large number of wells drilled and abandoned over time, that the records of wells drilled that are subsequently abandoned (in any future year) is a good proxy for the actual number of wells abandoned in a given year.
- (*Inherent in the IPCC method*) The emissions of hydrocarbons for offshore wells that are abandoned is estimated to be only 2% that compared to onshore wells, as the IPCC Refinement Tier 1 method states that it is assumed that 98% of hydrocarbons released will dissolve in the water column and not be emitted to atmosphere.
- As the activity dataset is available only for all *oil and gas* wells aggregated, the method applies the same EFs to the full estimate of all abandoned *oil and gas* wells; hence emissions that ideally ought to be reported under 1B2b for leaks from abandoned *gas* wells are included here. The EF for oil wells is assumed to be applicable for gas wells also.
- This is a minor source and **not a key category** for methane emissions and hence a Tier 1 method is proportionate. The UK regulatory system for mining and oil production and after-care requirements for former production sites is such that only low levels of seepage of hydrocarbons is expected. We note that whilst there are academic studies in the UK to research the rate of leakage of methane from individual abandoned oil and gas well sites, there are no country specific EFs available and hence no Tier 2 method option. Therefore, to apply the IPCC 2019 Refinement default is the best available dataset to address what would otherwise be a minor completeness issue in the UK GHGI.
- **Completeness**: In the UK there are no known omissions, the scope of reporting is complete. We note that NMVOC emissions may occur from these sources, notably from abandoned onshore oil wells, though no EFs for NMVOC are available from UK research

nor IPCC or EMEP/EEA inventory guidance;. There is no known activity of oil production in any OT or CD. There have been a small number of exploratory drilling campaigns offshore in the waters around the Falkland Islands, but no subsequent production and well abandonment.

- **Accuracy:** The method is Tier 1 using detailed AD for the UK and methods from the 2019 IPCC Refinement. The EFs are associated with high uncertainty (as high as -99 to 150% of the stated emission factor).
- **Time Series Consistency:** Annual NSTA data on oil wells drilled and their current status is available across the time series, including whether wells are suspended or abandoned, via the public wellbore status search facility. The method is therefore time series consistent.

### Scope for future research and improvement

- The Inventory Agency will continue to engage with NSTA to seek a solution that may enable us to derive a time series of wells abandoned in each year.
- Research to improve the understanding of well abandonment and capping would enable an improvement to the method to apply the IPCC default EFs (or other EFs) that are specific to (i) capped wells and (ii) uncapped wells, rather than using default EF provided for when capping is unknown (currently applied to the full activity data).
- There are no default EFs for NMVOC or specific hydrocarbons (e.g. benzene) in either IPCC nor EMEP-EEA guidebooks; there may be suitable EFs in other literature sources.

### Uncertainties

- The uncertainty parameters applied at category-gas level are presented in Annex 2.3.
- As noted above, the EFs are associated with high uncertainty; the 2019 Refinement cites a range of -99 to 150% of the stated EFs. The tier 1 method involves large uncertainties both in factor selection and also in determining whether an abandoned well has been plugged or not after decommissioning due to data limitations.
- The method complies with IPCC 2019 guideline for fugitive emissions from abandoned offshore and onshore oil wells. The Tier 1 approach has been applied as Tier 2 or 3 approaches are not available. We note that EFs for abandoned wells have high uncertainty. Activity data for this source are counts of total abandoned onshore and offshore wells in each year of the time series.
- Available information on abandoned wells do not indicate a clear distinction between abandoned oil and abandoned gas wells regarding practices or emission rates. Thus, all the EFs for 1.B.2.A/B.VII in IPCC 2019 are developed from data for both abandoned oil and gas wells. The EFs of abandoned wells are split into either “plugged” (or, properly decommissioned per regulations) and “unplugged” well sub-segments. If insufficient data on plugging practices is available to disaggregate activity data in such a way, the default EF for all type wells is to be used. More limited data are available on offshore wells and disaggregated (i.e. plugged versus unplugged) factors for offshore abandoned wells are developed in IPCC 2019 from onshore wells data considering that most methane (around 98%) from offshore abandoned wells is dissolved in marine water.

**1B2b2: Natural Gas Production****Emission Sources**

- Onshore natural gas production (conventional)
- Onshore natural gas gathering

These emission sources cover the release of fugitive gases from sources from the gas wellhead through to the delivery of gas to processing plants (where necessary), or to the connections to the National Transmission System. UK gas production onshore is limited to a small number of well sites, all conventional (i.e. no fracturing) and hence fugitives arise mainly from any leaks around the wellhead and through infrastructure (pipes, connectors, dehydrators, compressors).

**Pollutants Reported**

- Carbon dioxide, methane, nitrous oxide and NMVOC

**Method Summary**Onshore natural gas production (conventional)

- IPCC Tier 1 method:  $Emission = AD \times Default\ EF$
- Activity data: Annual volume of natural gas (million m<sup>3</sup>) produced, obtained from industry reporting to NSTA, DESNZ and their predecessors (DTI, DECC, BEIS):
  - **1990 to 1998**: DTI Brown Book. [1990, BB 1995 Appendix 7; 1991-1992, BB 1996 Annex 7; 1993-1995 BB 1998 Appendix 7; 1996-1998 BB 2001 Appendix 10; 1999 onwards is from DUKES Annex F2
  - **1999 onwards** from DUKES Annex F.2.
- Emission Factor(s): Default (D) EFs from IPCC. EF units are mass of pollutant emitted per million m<sup>3</sup> of natural gas produced onshore: *IPCC Refinement 2019 Table 4.2.4G: Tier 1 EFs for Natural Gas Production Segment, 1B2b2*. Onshore activities occurring with higher-emitting technologies and practices.
  - 4.09 t CH<sub>4</sub> / Mm<sup>3</sup>; 1.45 t CO<sub>2</sub> / Mm<sup>3</sup>; 0.98 t NMVOC / Mm<sup>3</sup>; 0.000025 t N<sub>2</sub>O / Mm<sup>3</sup>

Onshore natural gas gathering

- Method identical to the method presented above for onshore natural gas production (conventional), but applying the following EFs from *IPCC Refinement 2019 Table 4.2.4G: Tier 1 EFs for Natural Gas Production Segment, 1B2b2*. Onshore activities occurring with higher-emitting technologies and practices.
  - 3.20 t CH<sub>4</sub> / Mm<sup>3</sup>; 0.35 t CO<sub>2</sub> / Mm<sup>3</sup>; 0.77 t NMVOC / Mm<sup>3</sup>; 0.000006 t N<sub>2</sub>O / Mm<sup>3</sup>

**Method Assumptions and Observations**

- There is a very limited dataset to inform estimates from these minor sources from the UK onshore gas production sector, as there are no reported data to the Pollution Inventory.
- The annual level of fugitive releases per well site is below the reporting threshold for IED/PPC regulatory inventories, and the UK industry does not produce any country specific EFs or estimates of fugitive leaks; hence to apply the IPCC 2019 Refinement Tier 1 default method is proportionate to address what would otherwise be a minor completeness issue in the UK GHGI.
- **Completeness**: In the UK there are no known omissions, the scope of reporting is complete. We note that there are no EFs for GHG nor NMVOC from UK research or the industry.
- **Accuracy**: The method is Tier 1 using detailed AD for the UK and methods from the 2019 IPCC Refinement; hence uncertainties are high %s of very small emission estimates.

- **Time Series Consistency:** Annual natural gas production onshore data is available across the time series, via the UK energy statistics and previous annual statistics publications (DTI Brown Book). The method is therefore time series consistent.

### **Scope for future research and improvement**

- There is scope for UK research into the EFs applied for all sources in this section of the industry, but we note that given the relative insignificance of these sources that this is not a priority for improvement in future.

### **Uncertainties**

- The uncertainty parameters applied at category-gas level are presented in Annex 2.3.
- The EFs applied for onshore natural gas production are associated with high uncertainty; the 2019 Refinement indicates that CH<sub>4</sub> and CO<sub>2</sub> EF uncertainties are around  $\pm 20\%$ , whilst the range for N<sub>2</sub>O is -10% to +1000% and for NMVOC is -75% to +250%.
- The EFs applied for onshore natural gas gathering are associated with high uncertainty; the 2019 Refinement indicates that CH<sub>4</sub> and CO<sub>2</sub> EF uncertainties are around  $\pm 10\%$ , whilst the range for N<sub>2</sub>O is -10% to +1000% and for NMVOC is -75% to +250%.

**1B2b3: Natural Gas Processing****Emission Sources**

- Offshore gas production: Direct Processes
- Offshore gas production: Other fugitives
- Gas terminals: Direct processes
- Gas terminals: Other fugitives

These emission sources cover the release of fugitive gases from the processing units on upstream facilities, where the produced fluids are extracted, treated (e.g. to remove acid gases), separated to allow the onwards delivery or use of gas and condensate. The emissions arise from leaks on the platform / FPSO / terminal infrastructure, from pipes, flanges, connectors, compressors, dehydrators, separators and other units. In the UK the reporting of fugitive releases by operators tends to fall into two categories: (i) several installations report “direct process” emissions that are usually due to the treatment of acid gases which are processed or flared / incinerated leading (usually) to additional releases of CO<sub>2</sub> and other gases such as SO<sub>2</sub> (e.g. platforms: Elgin, Rough BD, Markham, and gas terminals: SAGE-St Fergus, Barrow, CATS, Point of Ayr, Theddlethorpe); and (ii) all offshore facilities and gas terminals report operational fugitive releases from leaking infrastructure, which are usually estimated based on an inventory of all of the equipment on the facility (i.e. counts of flanges, pipelines, connectors, compressors and so on) and UK industry EFs (from EEMS) on leaks per year per piece of equipment.

**Pollutants Reported**

- Carbon dioxide, methane, nitrous oxide, oxides of nitrogen, sulphur dioxide, carbon monoxide and NMVOC

**Method Summary**Offshore Gas Direct Processes and Fugitives<sup>14</sup>

- Tier 2/3 method, utilising the facility-level EEMS data for 1998 onwards, the industry-wide sector estimates for 1995 to 1997 (UKOOA 2005) and an estimate of direct process and fugitive emissions for 1990-1994 through extrapolation back from 1995 using natural gas production statistics. A small number of installations account for the direct process sources; emissions are dominated by CO<sub>2</sub> arising from sour gas treatment/venting and amine regeneration at the Elgin platform and from Rough BD platform. The time series of the annual gas production at each installation was used to estimate process emissions in pre-EEMS years.
- The EEMS data (BEIS, 2022a) present the AD in tonnes (of all gases released) and the emissions of individual gases including: CO<sub>2</sub>, CH<sub>4</sub>, N<sub>2</sub>O, NO<sub>x</sub>, NMVOC, CO, SO<sub>2</sub>. Emissions of fugitives (rather than direct process emissions) are dominated by CH<sub>4</sub> and NMVOC, with some reporting of CO<sub>2</sub> also evident.
- UK GHGI emissions =  $\sum$  operator emissions data per pollutant

Gas Terminal Direct Processes and Fugitives

- The method is as described for offshore units above, i.e. a UK industry Tier 2/3 method, utilising the facility-level EEMS data for 1998 to 2010 (when most terminals ceased reporting to EEMS), the industry-wide sector estimates for 1995 to 1997 (UKOOA 2005) and an estimate of direct process and fugitive emissions for 1990-1994 through

---

<sup>14</sup> An additional source reported in the UK GHGI as a fugitive emission is the emissions from the 2012 Elgin blow-out. A country-specific method was applied here, based on reported daily methane flow-rate observations taken on 5 days over the blow-out period. [This method was developed in previous research and is noted here for completeness.]

extrapolation back from 1995 using natural gas production statistics. The installations at SAGE-St Fergus and CATS terminals opened in 1992 and 1993 respectively; the Inventory Agency has estimated process releases back to those years (and zero emissions in 1990).

- For onshore terminals, the annual submissions to the PI/SPRI are verified by the regulatory agency, whereas EEMS data are not. Therefore, to align the inventory totals to these verified data, across all years where PI/SPRI > EEMS totals per pollutant, the inventory method allocates the residual emissions to this source category. Further, for 2011 onwards, where the *only* data reported are from the PI/SPRI, the inventory method across all sources aligns to the total reported to the PI/SPRI and estimates of direct process and fugitive emissions are modelled based on previously reported source estimates and the trend in annual emissions per pollutant, per installations.
- This source category is also used for residual emissions once all other source estimates have been made, for the 1990-1997 dataset. The UKOOA 2005 dataset provides source-specific estimates back to 1995, and the 1990-1994 estimates per source are modelled (see other method descriptions across 1A1cii and 1B2) using proxy data. CO<sub>2</sub> and N<sub>2</sub>O arise primarily from fuel combustion and gas flaring. For methane and NMVOC, the allocation of emissions across a range of sources is especially uncertain for 1990-1994; it is unknown whether the reported emissions from industry were from process sources, fugitive leaks, material storage or from venting. Our approach is to estimate specific allocations of methane and NMVOC from direct processes, storage and venting, and allocate the rest to “other fugitives” and report them here.

### Method Assumptions and Observations

- For process and fugitive sources where the EEMS emissions data are provided without any underlying AD and EF information, the UK inventory method is to aggregate those operator-reported data and conduct QC against other reported data (such as production data to identify when installations start and cease production) to ensure completeness.
- Fugitive emissions reported within EEMS are typically aggregated for each installation, without any further information on the specific source/unit. Similarly, emissions reported under IED/PPC to the PI/SPRI by terminal operators are aggregated across all sources on the defined installation. These national circumstances of data availability mean that the UK inventory data cannot be disaggregated to separate fugitive emissions from oil and gas processing units, from other fugitives, such as acid gas removal units (except where these are specifically identified as “direct process” sources), other connectors, flanges and pipeline infrastructure. The transparency of the underlying operator calculations is limited, and QC of the data focuses on time series consistency per installation.
- The time series of estimates is heavily influenced by reported data from a relatively small number of installations. As noted in the method overview, a number of sites have additional processing requirements due to, for example, the incidence of acid gases from the upstream gas / condensate fields. The UK GHGI trend is therefore influenced significantly by the production trends at those installations. As with all sources, there is greater uncertainty regarding the estimates at the start of the time series due to the limited data resolution in the UKOOA 2005 dataset, but IPCC good practice gap-filling techniques have been used to deliver a plausible time series per source.

### Scope for future research and improvement

- The method is reliant on the operator reporting to EEMS; in order to test against an IPCC default or other methodology (such as the fugitives methodology developed through research in Norway in recent years) would require significant investment to gathering more detailed data about the infrastructure on UK platforms, FPSOs and terminals. To develop a more comprehensive Tier 2 method would require UK regulators and industry to

generate more detailed activity and emissions data through either annual submissions or periodic research.

- For terminals there is an opportunity to update the requirements within IED/PPC permits (e.g. in response to the latest BREF notes) to include additional operator reporting (annual or periodic) of source-specific estimates, to supplement the installation-wide emission estimates that are currently reported to the PI/SPRI. Additional data (including AD or contextual info on e.g. production) would provide transparency of the source-specific emissions, and remove the need for assumptions to be applied to estimate the allocation of total emissions across fugitives, venting, storage, combustion etc, improving accuracy and opportunities to conduct QC.

### **Uncertainties**

- The uncertainty parameters applied at category-gas level are presented in Annex 2.3.
- In the latest year and considering the relative contributions to emission estimates per pollutant and the underlying methods and EFs, our expert judgement is that the activity data uncertainty is ~2-5% and the EF uncertainties are ~10% for CO<sub>2</sub>, 50% for CH<sub>4</sub> and 100% for N<sub>2</sub>O.

**1B2c1i: Upstream Oil Production, Venting; 1B2c1ii Upstream Gas Production, Venting****Emission Sources**

- Upstream oil production: venting
- Oil terminal: venting
- Upstream gas production: venting
- Gas terminal: venting

This source category comprises emissions from the venting of waste gases that arise through production activities for all upstream oil and gas installations on the UK Continental Shelf (UKCS) and onshore, i.e. including at offshore assets (platforms and FPSOs) and at onshore terminals. Venting releases comprise discharges of waste gas streams and process by-products, either through intentional releases or in emergencies; operators report a wide range of emissions as venting such as solution gas emissions from storage tanks, purging and blowdowns, pressure relief releases and disposal of waste gases or off-specification products where there is no option to flare. In operator reporting via EEMS, venting sub-sources include: emergency, maintenance and operational.

**Pollutants Reported**

- Carbon dioxide, methane, NMVOC and (rarely) nitrous oxide

**Method Summary**Offshore oil production: Venting and Offshore gas production: Venting

- UK industry Tier 2/3 method, utilising the facility-level EEMS data for 1998 onwards, the industry-wide sector estimates for 1995 to 1997 (UKOOA 2005) and an estimate of gas venting emissions for 1990-1994 through extrapolation back from 1995 using crude oil (for oil sites) or natural gas (for gas sites) production statistics.
- The EEMS data (BEIS, 2022a) present the emissions of individual gases including: CO<sub>2</sub>, CH<sub>4</sub>, and NMVOC with occasional reporting of other gases such as N<sub>2</sub>O, NO<sub>x</sub> and CO. The EEMS reporting of activity data is inconsistent; in most cases the EEMS AD are the sum of the mass of the individual gases, but in others no AD are reported. In the UK GHG inventory model and reporting outputs, we simply aggregate the emissions data per pollutant across all sites and report that as the emission and the EF, with AD = 1.
- UK GHGI emissions =  $\sum$  operator emissions per pollutant = EF ; AD = 1

Oil Terminals: Venting and Gas Terminals: Venting

- The method is as above, except that most terminals ceased to report emissions to EEMS beyond 2010 and hence for 2011 onwards, where the only data reported are from the PI or SPRI, there is no source resolution of reported emissions, only a total per pollutant per year per site. The inventory method for 2011 onwards therefore aligns to the total reported to the PI/SPRI across all sources, and an estimate of venting emissions has been modelled based on previously reported source estimates and the trend in annual site emission totals.

**Method Assumptions and Observations**

- EEMS data for venting are provided as emissions data without any underlying activity and emission factor information. The UK inventory method is to aggregate those operator-reported data and conduct QC against other reported data (such as production data to identify when installations start and cease production) to ensure completeness of reporting. In a small number of cases, operators may report gases other than CO<sub>2</sub>, CH<sub>4</sub>



and NMVOC under venting in EEMS; where there are reports of small amounts of N<sub>2</sub>O, NO<sub>x</sub> and CO reported as venting in EEMS, these data are included in the inventory, assuming that there are some waste combustion gases recorded as vented, e.g. from maintenance activities. This happens rarely and the mass of these gases is always very low; they may be misallocated, but it is a minor issue.

- **Completeness:** In the UK there are no known omissions, the scope of reporting is complete. Time-series checks by the Inventory Agency are used to assess the completeness of reporting each year; there are a small number of terminals that regularly report notable venting emissions, whilst offshore there are tens of installations that report notable venting of hydrocarbons (methane and NMVOC), and a small number (Elgin, Shearwater, Brae only in recent years) that report venting of CO<sub>2</sub>. Onshore terminals that routinely report notable venting emissions include: Flotta, Theddlethorpe, SAGE-St. Fergus, Shell-St Fergus, Barrow and Bacton.
- **Accuracy:** The method is Tier 2/3 across the time series, using the best available data from operator reporting throughout. Noting that in many cases the operator estimates are not presented via an “activity” and “emission factor” but rather are direct estimates of the gases vented from monitoring of the gas throughput and an assumed gas composition, the accuracy is hard to evaluate. Where there are installation-specific processes (e.g. acid gas stripping) that lead to high emissions of vented gases (e.g. Shearwater and Elgin often encounter high-CO<sub>2</sub> produced gases that cannot be flared; several terminals vent the process gases from fuel gas treatment facilities) the composition of the gases is monitored by operators. Smaller-scale vented emissions may be estimated through engineering calculations and default data on gas composition.
- **Time Series Consistency:** The method is compromised by the lack of fully detailed data for the 1990-1997 period, where only aggregate emissions data across all sources in 1A1cii and 1B2 are available from the industry submissions to UK Government. However, the Inventory Agency has conducted validation checks across the UKOOA dataset versus EEMS data in overlap years, which indicates good time series consistency, and the Inventory Agency has deployed gap-filling methods consistent with the 2006 IPCC Guidelines to develop time series consistent reporting per source category back to the early 1990s. Therefore, the time series consistency is as good as practicable, given the limited resolution of the available industry emissions and activity data.

### Scope for future research and improvement

- The method is reliant on the operator reporting to EEMS. The PPRS monthly reports also include data on venting. Comparisons of PPRS and EEMS data during this project have indicated that for many sites there is good correlation between EEMS and PPRS, whilst for other sites there are gaps in the PPRS data where EEMS includes venting estimates. This indicates that PPRS is not always reliable for QC of EEMS and/or to inform better estimates. The NSTA has recently begun to consider revisions to the system of flare and vent consents, and there may be scope to establish better quality routine reporting of gas venting through the PPRS system, which could then provide an additional data source or QC step for the inventory.

### Uncertainties

- The uncertainty parameters applied at category-gas level are presented in Annex 2.3.
- Uncertainties of emissions reported are based on expert judgement, informed by the understanding of the available data and the likelihood of error compensation across all UK installations.
- In the latest year of the time series, the uncertainty for venting is estimated to be ±5% for CO<sub>2</sub>, 100% for CH<sub>4</sub>, whilst in the Base Year (1990) the uncertainty is assumed to be ±20%

for CO<sub>2</sub> and 100% for CH<sub>4</sub> due to the more limited information available from industry and assumptions applied to estimate venting emissions.

- The limited alternative data against which the EEMS data can be validated undermines confidence in the accuracy and completeness of the venting estimates.

**1B2c2i: Upstream Oil Production, Gas Flaring; 1B2c2ii Upstream Gas Production, Gas Flaring****Emission Sources**

- Upstream oil production: gas flaring
- Oil terminal: gas flaring
- Onshore oil production: gas flaring
- Upstream gas production: gas flaring
- Gas terminal: gas flaring

This source category comprises emissions from the flaring of waste gases that arise through production activities for all upstream oil and gas installations on the UK Continental Shelf (UKCS) and onshore, i.e. including at offshore assets (platforms, FPSOs, MODUs), at onshore terminals and at onshore production sites. The gases may need to be flared to address operational issues (e.g. excess gas supply), structural issues (e.g. some platforms/FPSOs that produce crude oil and associated gas do not have any gas export line), safety issues. In operator reporting by offshore operators to OPRED, via EEMS, flaring sub-sources include: routine operations, gross, maintenance, upsets / other. Flaring of gases is also conducted at oil and gas terminals, again to manage waste gas and maintain operational and safety standards across the sites. For all offshore production sites and terminals, gas flaring emissions are reported by operators under UK ETS (formerly EU ETS) since 2008, i.e. from EU ETS Phase 2 onwards, and within EEMS from 1998 onwards.

Onshore oil well sites are smaller production sites in the UK context but do still conduct a small amount of gas flaring during production; separate flaring estimates are made for these sites, for completeness.

*The flaring of waste gases during well exploration and testing is reported separately under the 1B2a1 and 1B2b1 IPCC source categories for oil and gas well testing respectively. This enables a distinction to be made between emissions from exploration activities, and emissions from production activities.*

**Pollutants Reported**

- Carbon dioxide, methane, nitrous oxide, oxides of nitrogen, carbon monoxide, sulphur dioxide, NMVOCs

**Method Summary**

The emission estimates across the time series are based on the sum of the best available data from upstream oil and gas operators, onshore and offshore. The method since 1998 is essentially a Tier 3 method, aggregating installation-level activity and emission estimates. Estimates for 1990-1997 are based on lower resolution source data but are still a Tier 2 method, using industry-wide estimates from the trade association (UKOOA 2005). This data was derived from operator surveys through the 1990s and assumes that carbon emission factors from gas flaring from 1998 are representative for earlier years.

Offshore oil production: Gas Flaring and Offshore gas production: Gas Flaring and

Oil Terminals: Gas Flaring and Gas Terminals: Gas Flaring

- UK industry Tier 2/3 method, utilising the facility-level UK ETS data for 2008 onwards and EEMS data for 1998-2007, the industry-wide sector estimates for 1995 to 1997 (UKOOA 2005) and an estimate of gas flaring emissions for 1990-1994 through extrapolation back from 1995 using crude oil (for oil sites) or natural gas (for gas sites) production statistics.

- The EEMS data (BEIS, 2022a) present the AD of gas flaring in tonnes and the emissions of individual gases including: CO<sub>2</sub>, CH<sub>4</sub>, N<sub>2</sub>O, NO<sub>x</sub>, NMVOC, CO, SO<sub>2</sub>. The UK ETS (formerly EU ETS) data provide the AD of gas flared in tonnes together with the carbon emission factor and verified CO<sub>2</sub> emissions total per flaring source per installation. As such the UK ETS data are considered highly accurate; they provide a rich and detailed dataset that exhibits a range of variability in the flared gas composition across installations. Reporting to both EEMS and UK ETS is underpinned by the sector-wide assumption of 98% oxidation of flared gas.
- UK GHGI emissions =  $\sum$  operator emissions data per pollutant
- Activity data =  $\sum$  operator activity data (tonnes): IEF = Emissions / AD

### Onshore oil production: Gas Flaring

- IPCC Tier 2 method: *Emission = AD x Country Specific EF*
- Activity data: Annual mass of gas flared at onshore oil production facilities, obtained from industry reporting to NSTA, DESNZ and their predecessors (DTI, DECC, BEIS):
  - **1990 to 1999**: Estimates of mass flared derived from the reported volumes of gas flared by DTI at onshore fields, scaled according to the mass and volume data for flaring at offshore fields, i.e. assuming similar gas density;
  - **2000 onwards** from monthly returns under PPRS for onshore loader fields.
- Emission Factor(s): The EF derived for offshore oil production per year is applied to the onshore flaring AD, as the best estimate of emissions per unit mass gas flared, as there are no operator-reported emissions data nor EFs from these smaller onshore well sites.

### **Method Assumptions and Observations**

- Note that where the gas flaring emissions are reported for an installation via both EEMS and UK ETS, the UK ETS data are regarded as better quality as they are subject to Third Party verification, as part of the requirements of the trading scheme.
- The estimates of methane emissions from gas flaring are amongst the most uncertain of all estimates of GHGs from the upstream oil and gas sector. The EEMS operator guidance methane EF and the accepted UK ETS sector-wide methodology (to estimate CO<sub>2</sub> emissions under UK ETS) are based on a sector-wide assumption that the oxidation of flared gases is 98%. There is no routine monitoring and reporting of the performance of flares to industry regulators. Consultation with operators and regulators indicates that there is a variable approach by operators to track, monitor and resolve issues such as unlit flares, which will instead be cold venting flare gases. During such events, methane emissions will be much higher and carbon dioxide emissions much lower than the estimates reported based on the measurement of the amount of gas to flare and applying the 98% oxidation factor assumption. While the analysis of emission plumes in the North Sea between 2018 and 2019 found that the assumption is reasonable (Shaw et al., 2022), we note that just a small under-performance in flare efficiency below the 98% industry assumption will lead to a significant increase in methane emissions and an under-report in inventory estimates (e.g. a 96% flare efficiency equates to double the reported methane emissions).
- Gas flaring is a minor source of emissions of nitrous oxide. Operators report estimates to EEMS, predominantly applying defaults from operator guidance, and hence this is essentially a Tier 2 approach. The Inventory Agency gap-fills reported data where necessary, using the default EF.
- Gas flaring at onshore well sites is a small component of total flaring emissions, e.g. in 2020 it is estimated to account for 0.6% of total flaring GHG emissions. The available data for this source is limited to activity data across the time series, with assumptions applied

to use the EF from offshore oil production facilities and to derive the AD in the early part of the time series. This component of the gas flaring estimates is therefore subject to greater uncertainty than the well-documented other sources (offshore and at terminals).

- **Completeness:** In the UK there are no known omissions, the scope of reporting is complete. The Inventory Agency draws upon a range of data sources to ensure completeness (and accuracy), using UK ETS supplemented by EEMS data for smaller installations that fall below the UK ETS reporting threshold.
- **Accuracy:** The method is Tier 2/3 across the time series, using the best available data from operator reporting throughout. In the UK there has been a high level of flare gas compositional analysis to inform UK ETS allocations (from the National Allocation Plans from 1998 onwards) and subsequently in all operator submissions to UK ETS. Further, the stringent monitoring and reporting and other QAQC requirements of the UK ETS system gives confidence that the reported mass of flare gas sent to flare per installation per year is highly accurate. As noted above, the biggest source of potential inaccuracy in GHG estimates is the assumption across all operator reporting that flare oxidation efficiency is 98%; deviation from that assumed level of oxidation will impact both the methane and carbon dioxide estimates.
- The 1990-1997 data are based on the UKOOA 2005 report to UK Government, which took account of the work in the National Allocation Plans to derive better installation-level carbon emission factors but are based on more limited industry surveys from the early 1990s and hence are associated with higher uncertainty than the later data.
- **Time Series Consistency:** The method is compromised by the lack of fully detailed data for the 1990-1997 period, where only aggregate emissions data across all sources in 1A1cii and 1B2 are available from the industry submissions to UK Government. Therefore, the time series consistency is “as good as possible” given the limitations of the available data.

## QA/QC

Specific QA/QC and validation exercises relevant to these source categories include:

- Comparisons between EEMS and UK ETS, to review installation-specific activity data and CO<sub>2</sub> emissions data (and hence implied IEFs for each site and source) to identify any possible gaps in the EEMS dataset, using UK ETS as a de-minimis. The UK ETS data quality (AD, EFs) are third-party verified and hence regarded as the more accurate dataset;
- Comparisons of total emissions data reported by each onshore oil and gas installation via the Pollution Inventory/Scottish Pollutant Release Inventory/Welsh Emissions Inventory to assess time-series consistency and completeness of reporting, comparing CO<sub>2</sub> emissions data against those presented in UK ETS (and EEMS if the terminal reports to EEMS also).

## Scope for future research and improvement

- A priority for further research is to develop a more rigorous and comprehensive evidence base for flare performance at all upstream installations, especially for those that operate offshore in potentially harsh conditions and with more limited opportunities for flare stack maintenance. Emission estimates are currently very sensitive to the assumption that 98% of flared gas is oxidised and, while recent evidence has supported this (Shaw et al., 2022), uncertainty remains high. Confidence could be improved by obtaining measurement data on the performance of different flare stack types (enclosed or open flare designs etc.) and the development of more rigorous and consistent operator monitoring and reporting systems to track when flares are operational, when they are unlit, and the volume/mass of flare gas passed to the flare stack during these different periods of operation. Consultation

with industry would also be useful in understanding the changes in flaring practises over the timeseries.

## **Uncertainties**

- The uncertainty parameters applied at category-gas level are presented in Annex 2.3.
- Uncertainties for both AD and EFs are based on expert judgement, informed by the understanding of the available data, the level of uncertainty that is accepted within the reporting systems (e.g. UK ETS) and the likelihood of error compensation across all UK installations.
- In the latest year of the time series, the AD uncertainty for gas flaring is estimated to be  $\pm 5\%$ , whilst in the Base Year (1990) the AD uncertainty is assumed to be  $\pm 20\%$  due to the more limited information available from industry and assumptions applied to estimate flaring activity.
- Across the time series, the CO<sub>2</sub> EF uncertainty is estimated to be  $\pm 5\%$  whilst the uncertainty in the EFs for both methane and nitrous oxide are estimated to be  $\pm 100\%$  across all installations, reflecting the uncertainty in oxidation factor assumption (for methane) and the widespread use of a default EF (for nitrous oxide).
- Uncertainties in flaring AD are typically low. However, we note (as outlined above) that there are different operator flare stack monitoring (lit/unlit) practices evident (across the time series) and also that there are less detailed activity and emissions data available for the 1990-1997 period. Hence uncertainties for the estimates in 1990 are higher than for recent years where much more detailed and complete operator-reporting of activity and emissions are evident.
- The CO<sub>2</sub> EFs are based on UK-specific data, from sampling and compositional analysis of gas sent to flare. Despite the uncertainty regarding the assumed gas flaring oxidation factor, across the sector the uncertainty of the CO<sub>2</sub> EF is still expected to be low, however the uncertainty of the CH<sub>4</sub> EF is considered to be high.

## **A 3.2 INDUSTRIAL PROCESSES (CRF SECTOR 2)**

There is currently no additional information for this sector in this Annex.

## **A 3.3 AGRICULTURE (CRF SECTOR 3)**

Note that the references for this section are included in **Section 17.4**.

**Table A 3.3.1 Livestock Population Data by Animal Type ('000 animal places)**

Livestock Category	1990	1995	2000	2005	2010	2015	2020	2021
Total cattle	12,125	11,760	11,048	10,698	10,014	9,785	9,429	9,445
- dairy cows	2,848	2,603	2,336	2,003	1,839	1,906	1,853	1,856
- all other cattle	9,277	9,157	8,713	8,695	8,175	7,879	7,577	7,589
Sheep	45,475	44,233	43,154	36,140	31,724	34,032	33,427	33,641
Pigs	7,548	7,627	6,482	4,862	4,468	4,739	5,069	5,323
Total poultry	138,381	142,267	169,773	173,909	163,842	167,579	182,882	189,853
- laying hens	33,624	31,837	28,687	29,544	28,751	28,311	31,067	30,788
- broilers	73,944	77,177	105,689	111,475	105,309	107,056	120,047	126,584
Total horses	570	684	1,006	1,036	1,024	978	932	927
- horses kept on agricultural holdings	202	273	287	346	312	283	236	231
- professional horses	62	62	70	91	91	87	87	87
- domestic horses	305	348	649	599	621	608	608	608
Goat	98	75	74	95	93	101	112	111
Deer	47	37	36	33	31	31	38	46

### A 3.3.1 Enteric Fermentation (3A)

**Table A 3.3.2 Methane Emission Factors for Livestock Emissions for 2021**

Animal type		Enteric methane kg CH <sub>4</sub> /head/year	Methane from manures kg CH <sub>4</sub> /head/year
Cattle	Dairy cows	123.97	38.26
	Dairy heifers	54.92	6.23
	Dairy replacements >1 year	51.37	5.94
	Dairy calves <1 year	43.66	3.83
	Beef cows	76.25	10.79
	Beef females for slaughter	49.17	5.79
	Bulls for breeding	57.90	8.07
	Cereal fed bull	49.85	9.01
	Heifers for breeding	48.51	6.34
	Steers	50.10	5.87
Pigs		1.50	4.03
Sheep	Ewes	7.10	0.19
	Rams	8.25	0.23
	Lambs	3.07	0.07
Other livestock	Goats	9.0	0.39
	Horses	18.0	0.41
	Deer	20.0	0.22
Poultry	Laying hens	NA	0.017
	Growing pullets	NA	0.008
	Broilers	NA	0.019
	Turkeys	NA	0.065
	Breeding flock	NA	0.008
	Ducks	NA	0.131
	Geese	NA	0.134
	All other poultry	NA	0.008



### A 3.3.2 Manure Management (3B)

#### A 3.3.2.1 Methane emissions from animal manures

**Table A 3.3.3 Methane conversion factors for Manure Management Systems in the UK**

Manure Handling System	Methane Conversion Factor %
Liquid <sup>a</sup>	17
Daily spread	0.1
Deep bedding/farmyard manure – cattle, pigs	17
Deep bedding/farmyard manure – sheep	2.0
Pasture range and paddock	1.0
Poultry manure	1.5
Anaerobic digestion - cattle <sup>b</sup>	3
Anaerobic digestion - pigs <sup>b</sup>	4
Anaerobic digestion - poultry <sup>b</sup>	1.5

<sup>a</sup>No differentiation is made between crusted and non-crusted slurry storage

<sup>b</sup>Values used for the anaerobic digestion of livestock manures are based on the values used in the German inventory

**A 3.3.2.2 Nitrous Oxide emissions from Animal Waste Management Systems**

**Table A 3.3.4 Nitrogen Excretion Factors, kg N animal place<sup>-1</sup> year<sup>-1</sup> for livestock in the UK (1990-2021)**

Livestock Category	1990	1995	2000	2005	2010	2015	2020	2021
Dairy cows	85.5	87.5	93.5	102.4	104.5	111.1	118.2	118.7
Other cattle <sup>a</sup>	39.8	41.2	43.2	44.7	45.7	45.7	44.5	44.4
Sows	23.6	22.5	21.4	20.6	20.8	21.1	21.1	21.1
Gilts	15.5	15.5	15.5	15.2	13.6	12.0	11.7	11.7
Boars	28.8	27.4	26.1	24.5	22.0	19.4	18.9	18.9
Fatteners > 80 kg	20.2	19.3	18.4	17.2	15.4	13.5	13.2	13.2
Fatteners 20-80 kg	14.6	13.9	13.2	12.4	11.1	9.9	9.6	9.6
Weaners (<20 kg)	4.6	4.4	4.2	4.0	4.0	4.0	4.0	4.0
Ewes	8.3	8.5	8.6	8.6	8.3	8.6	8.8	8.8
Rams	11.3	11.4	11.4	11.3	11.1	11.2	11.4	11.3
Lambs	3.7	3.8	3.9	4.1	4.0	4.2	4.2	4.3
Goats	8.4	8.4	8.4	8.4	8.4	8.4	8.4	8.4
Horses								
– horses kept on agricultural holdings	50	50	50	50	50	50	50	50
– professional horses	129	129	129	129	129	129	129	129
– domestic horses	50	50	50	50	50	50	50	50
Deer	29.3	29.3	29.3	29.3	29.3	29.3	29.3	29.3

Livestock Category	1990	1995	2000	2005	2010	2015	2020	2021
Laying hens	0.87	0.84	0.80	0.77	0.76	0.74	0.74	0.73
Broilers	0.64	0.59	0.55	0.49	0.40	0.30	0.28	0.28
Turkeys	1.50	1.59	1.68	1.75	1.77	1.78	1.78	1.78
Pullets	0.42	0.39	0.36	0.34	0.35	0.36	0.36	0.36
Breeding flock	1.16	1.13	1.10	1.09	1.11	1.14	1.14	1.14
Ducks	1.30	1.41	1.52	1.57	1.40	1.23	1.20	1.20
Geese	1.30	1.41	1.52	1.57	1.40	1.23	1.20	1.20
Other poultry	1.30	1.41	1.52	1.57	1.40	1.23	1.20	1.20

<sup>a</sup> Weighted average for all other cattle categories

**Table A 3.3.5 Distribution of Animal Waste Management Systems (%) used for Different Animal types, 2021**

Animal Type		Liquid System	Daily Spread	Solid storage/Deep litter/Poultry litter <sup>b</sup>	Pasture Range and Paddock	Anaerobic digestion
Cattle	Dairy cows	61	8	9	20	2
	All other cattle	19	12	20	49	1
Pigs	All pigs	36	15	34	10	4
Sheep	Ewes	0	0	8	92	0
	Rams	0	0	1	99	0
	Lambs	0	0	1	99	0
Other livestock	Goats	0	0	8	92	0
	Deer	0	0	25	75	0
	Horses	0	0	30	70	0
Poultry	All poultry	0	33	51	4	12

Table A 3.3.6 Other agricultural waste management data and parameters

## a) Quantities of poultry manure incinerated as kt and expressed as % of broiler and turkey manure for each Devolved Administration

	1990	2000	2005	2010	2015	2020	2021
<b>Litter incinerated, UK (kt)</b>	0	465	660	648	676	605	615
<b>% of broiler and turkey litter:</b>							
<b>England</b>	0	19	29	32	35	29	28
<b>Wales</b>	0	0	0	0	0	0	0
<b>Scotland</b>	0	61	64	58	77	61	70
<b>Northern Ireland</b>	0	0	0	0	3	3	3

## b) Amounts of poultry litter exported from Northern Ireland to be incinerated in England and Scotland

	2015	2016	2017	2018	2019	2020	2021
Amount of poultry litter sent from Northern Ireland for incineration in England, t	1,160	4,650	2,026	0	0	3,163	3,163
Amount of poultry litter sent from Northern Ireland for incineration in Scotland, t	7,403	5,142	4,127	0	4,871	6,169	6,169

c) Direct N<sub>2</sub>O Emission Factors for Animal Waste Management Systems

Emission source	EF (% of total N)	Uncertainty limits (95% CI)	Data source
<b>Cattle manure management</b>			
Slurry – solid floor	0	N/A	IPCC 2006
Slurry – slatted floor	0.2	Factor of 2	IPCC 2006
FYM systems	2.0	Factor of 2	UK measurement (at storage)
Outdoor yards	0	N/A	IPCC 2006
<b>Pig manure management</b>			
Slurry – slatted floor	0.2	Factor of 2	IPCC 2006

<b>Emission source</b>	<b>EF (% of total N)</b>	<b>Uncertainty limits (95% CI)</b>	<b>Data source</b>
FYM systems	2.0	Factor of 2	UK measurement (at storage)
<b>Sheep manure management (FYM)</b>	0.5	Factor of 2	IPCC 2006
<b>Layer manure management</b>	0.5	Factor of 2	UK measurement (at storage)
<b>Broiler manure management</b>	0.5	Factor of 2	UK measurement (at storage)
<b>Ducks and geese manure management</b>	2.0	Factor of 2	Based on cattle/pig
<b>Turkeys manure management</b>	0.5	Factor of 2	UK measurement (at storage)
<b>Other poultry manure management</b>	0.5	Factor of 2	UK measurement (at storage)
<b>Goats, deer and horses manure management</b>	2	Factor of 2	UK measurement (at storage)
<b>Anaerobic digestion</b>	0	N/A	IPCC 2006

CS EFs presented in this table are derived from UK measurements as described in documents available on request

### A 3.3.3 Agricultural Soils (3D)

**Table A 3.3.7 Percentage of layer manure and all other poultry manure applied to cropland**

	1990	1995	2000	2005	2010	2015	2020	2021
% of layer manure spread to cropland	53	53	67	70	70	70	70	70
% of all other poultry manure spread to cropland	53	53	67	82	82	82	82	82

**Table A 3.3.8 Other Organic N Fertilisers applied to soils – manure and non-manure based digestates**

	1990	1995	2000	2005	2010	2015	2020	2021
N input from manure based digestate applied to soils (kt N/y)	19,140	46,083	49,792	140,684	790,836	10,229,798	20,837,501	20,905,684
Direct N <sub>2</sub> O emissions from manure based digestate applied to soils (kt N <sub>2</sub> O/y)	0.0002	0.0005	0.0006	0.0017	0.0093	0.1202	0.2448	0.2456
N input from crop based digestate applied to soils (kt/y)	0	0	0	596	916,078	13,234,801	20,392,925	20,778,690
Direct N <sub>2</sub> O emissions from crop based	0	0	0	0.00001	0.01440	0.20798	0.32046	0.32652

	1990	1995	2000	2005	2010	2015	2020	2021
digestate applied to soils (kt N <sub>2</sub> O/y)								
N input from food based digestate applied to soils (kt/y)	0	0	0	894,125	3,711,425	18,752,915	28,685,445	29,625,445
Direct N <sub>2</sub> O emissions from food based digestate applied to soils (kt N <sub>2</sub> O/y)	0	0	0	0.01405	0.05832	0.29469	0.45077	0.46554
N input from other organic residue digestate applied to soils (kt N/y)	0	0	670	345,720	377,545	2,153,916	3,216,419	3,246,569
Direct N <sub>2</sub> O emissions from other organic residue digestate applied to soils (kt N <sub>2</sub> O/y)	0	0	0.00001	0.00543	0.00593	0.03385	0.05054	0.05102



**Table A 3.3.9 EF for direct N<sub>2</sub>O emissions from managed soils in the UK inventory**

Emission source	EF (% of total N)	Uncertainty	Data source
Urea fertiliser	Non-linear function of application rate (see Section 5.5.2.1)		Topp et al., in prep
Other mineral fertilisers	Non-linear function of application rate and annual rainfall (see Section 5.5.2.1)		Topp et al., in prep
Livestock slurry	0.7475	SE 0.17328	Topp et al., in prep
Livestock solid manure (FYM)	0.33	SE 0.07	Topp et al., in prep
Poultry manure	1.01	SE 0.15	Topp et al., in prep
Sewage sludge	1.0	0.3 – 3.0	IPCC 2006
Manure-based digestate	0.7475	SE 0.17328	Topp et al., in prep
Non-manure based digestate	1.0	0.3 – 3.0	IPCC 2006
Crop residues	1.0	0.3 – 3.0	IPCC 2006
N mineralisation	1.0	0.3 – 3.0	IPCC 2006
Histosols - cropland	16.28 kg N <sub>2</sub> O-N/ha	SE 4.423	DEFRA report SP0822: Aligning The Peatland Code With The UK Peatland Inventory
Histosols – intensive grassland	7.39 kg N <sub>2</sub> O-N/ha	SE 1.642	DEFRA report SP0822: Aligning The Peatland Code With The UK Peatland Inventory
Cattle urine	0.629	SE 0.0930	Topp et al., in prep
Cattle dung	0.193	SE 0.0212	Topp et al., in prep
Sheep urine	0.315	SE 0.0658	Topp et al., in prep, IPCC 2019
Sheep dung	0.097	SE 0.0150	Topp et al., in prep, IPCC 2019
Outdoor goats, horses and deer	0.3	0.0 – 1.0	IPCC 2019
Outdoor pigs and poultry	0.4	0.0 – 1.4	IPCC 2019

**Table A 3.3.10 Areas of UK Crops and quantities of fertiliser applied for 2021**

Crop Type	Crop area, ha	Fertiliser, ktN	Crop Type	Crop area, ha	Fertiliser, ktN
Oats	165,845	17.2	Potatoes (maincrop)	112,878	13.0

Crop Type	Crop area, ha	Fertiliser, ktN	Crop Type	Crop area, ha	Fertiliser, ktN
Spring oats	23,756	1.6	Potatoes (seed or earlies)	24,072	2.8
Winter oats	9,983	0.7	Sugar beet	95,249	6.6
Spring barley	12,898	1.1	Maize	95,815	6.2
Spring barley (malting)	425,867	42.2	Grain maize	14,762	0.9
Spring barley (non-malting)	306,088	29.6	Forage maize	116,469	6.7
Winter barley	7,944	1.2	Rootcrops for stockfeed	38,965	2.6
Winter barley (malting)	70,076	8.8	Leafy forage crops	4,544	0.2
Winter barley (non-malting)	326,872	47.0	Other fodder crops	52,855	1.8
Wheat	7,734	1.2	Vegetables (not-differentiated)	1,650	0.1
Wheat (milling)	655,352	127.7	Vegetables (brassicas)	5,437	0.3
Wheat (non-milling)	1,127,309	199.7	Vegetables (legumes)	44,788	2.7
Minor cereals	70,819	7.9	Vegetables (other non-legumes)	65,218	4.1
Oilseed rape	5,691	1.0	Other horticultural crops	16,358	1.0
Spring oilseed rape	6,735	1.1	Soft Fruit	7,483	0.4
Winter oilseed rape	294,863	50.6	Top Fruit	23,216	1.4
Linseed	40,907	3.7	Miscanthus	7,829	0.1
Field beans (harvested dry)	186,861	0.2	Willow (short rotation coppice)	4,171	0.1
Field peas (harvested dry)	60,732	0.1	Other field crops	30,338	0.5
Fruit (mixed top & soft fruit)	12	0.0	Wine grapes	2,762	0.2
Permanent grass	6,070,944	287.1	Temporary grass	1,216,835	115.4

## Other Detailed Methodological Descriptions **A3**

**Table A 3.3.11 Trends in area grown ('000 ha) and N fertiliser applied (kg/ha) for the major UK crops, 1990-2021**

Year	Wheat		Spring barley		Winter barley		Main crop potatoes		Oilseed rape		Grass leys (<5yrs)		Permanent grassland	
	'000 ha	kg/ha N	'000 ha	kg/ha N	'000 ha	kg/ha N	'000 ha	kg/ha N	'000 ha	kg/ha N	'000 ha	kg/ha N	'000 ha	kg/ha N
1990	2,014	183	635	90	882	140	148	184	390	226	1,606	166	5,316	108
1991	1,981	189	553	90	841	142	148	188	440	225	1,607	168	5,314	107
1992	2,067	185	515	89	784	141	151	175	421	197	1,582	157	5,266	95
1993	1,759	182	518	90	649	134	143	187	377	177	1,581	146	5,261	100
1994	1,811	189	481	95	627	145	138	194	404	182	1,455	170	5,375	110
1995	1,859	193	504	97	689	144	144	176	354	187	1,407	170	5,375	108
1996	1,977	185	519	93	749	140	149	171	356	190	1,393	166	5,338	105
1997	2,036	191	519	93	840	143	133	166	445	199	1,403	147	5,266	103
1998	2,045	182	484	91	769	136	131	187	506	193	1,302	156	5,365	99
1999	1,847	186	631	99	548	143	148	154	493	197	1,226	180	5,449	101
2000	2,086	191	539	107	589	148	138	159	393	192	1,226	142	5,363	90
2001	1,635	193	783	114	462	150	137	160	444	205	1,205	130	5,584	84
2002	1,996	193	555	112	546	153	129	154	436	198	1,243	135	5,519	77
2003	1,836	197	621	107	455	148	118	149	549	194	1,200	129	5,683	75
2004	1,990	187	587	98	420	144	121	144	498	193	1,246	116	5,620	71
2005	1,870	184	553	97	384	139	113	140	588	196	1,193	108	5,711	65

## Other Detailed Methodological Descriptions **A3**

Year	Wheat		Spring barley		Winter barley		Main crop potatoes		Oilseed rape		Grass leys (<5yrs)		Permanent grassland	
	'000 ha	kg/ha N	'000 ha	kg/ha N	'000 ha	kg/ha N	'000 ha	kg/ha N	'000 ha	kg/ha N	'000 ha	kg/ha N	'000 ha	kg/ha N
2006	1,836	176	494	96	388	132	117	144	568	182	1,137	106	5,967	60
2007	1,830	179	515	92	383	132	112	131	674	184	1,176	98	5,965	55
2008	2,080	176	616	93	416	134	114	154	598	185	1,141	91	6,036	45
2009	1,814	186	749	98	411	137	118	161	581	179	1,262	86	6,081	47
2010	1,939	190	539	97	382	141	114	132	642	194	1,231	99	5,925	53
2011	1,969	192	611	97	359	140	120	153	705	195	1,278	92	5,877	51
2012	1,992	194	618	99	385	147	123	134	756	187	1,357	91	5,799	50
2013	1,615	184	903	107	310	145	114	166	715	174	1,390	96	5,802	54
2014	1,936	191	651	106	429	145	115	140	675	191	1,396	100	5,824	51
2015	1,832	194	659	105	442	148	105	155	652	191	1,167	97	6,078	49
2016	1,823	186	683	105	439	146	114	130	579	182	1,144	94	6,118	50
2017	1,792	183	754	101	423	149	121	133	562	180	1,144	96	6,135	49
2018	1,748	183	751	100	387	143	117	135	583	188	1,152	95	6,178	52
2019	1,816	185	710	97	453	145	120	153	530	183	1,193	95	6,207	49
2020	1,389	170	1,074	100	312	141	119	117	381	173	1,181	94	6,122	49
2021	1,790	184	745	98	405	141	113	115	307	171	1,217	95	6,071	47

## Other Detailed Methodological Descriptions **A3**

### A 3.3.3.1 Crop Residues

**Table A 3.3.12 Parameter values for crop residue management**

Crop	Crop Harvest Index <sup>a</sup>	Above Ground Residue Retained after harvest	IPCC Crop Yield To Above Ground Residue Slope <sup>b</sup>	IPCC Crop Yield To Above Ground Residue Intercept <sup>b</sup>	IPCC Above To Below Ground Residue ratio
Oats	0.46	0.5	NA	NA	0.25
Spring oats	0.46	0.5	NA	NA	0.25
Winter oats	0.46	0.5	NA	NA	0.25
Spring barley	0.52	0.5	NA	NA	0.22
Spring barley (malting)	0.52	0.5	NA	NA	0.22
Spring barley (non-malting)	0.52	0.5	NA	NA	0.22
Winter barley	0.52	0.5	NA	NA	0.22
Winter barley (malting)	0.52	0.5	NA	NA	0.22
Winter barley (non-malting)	0.52	0.5	NA	NA	0.22
Wheat	0.50	0.5	NA	NA	0.23
Wheat (milling)	0.50	0.5	NA	NA	0.23
Wheat (non-milling)	0.50	0.5	NA	NA	0.23
Minor cereals	0.49	0.5	NA	NA	0.23
Oilseed rape	0.30	1	NA	NA	0.35
Spring oilseed rape	0.30	1	NA	NA	0.35
Winter oilseed rape	0.30	1	NA	NA	0.35
Linseed and Flax	0.38	0.5	NA	NA	0.35
Linseed	0.38	1	NA	NA	0.35
Flax	0.38	0.2	NA	NA	0.35
Field beans and peas combined	NA	1	1.13	0.85	0.19
Potatoes	NA	1	0.10	1.06	0.20
Potatoes (maincrop)	NA	1	0.10	1.06	0.20

## Other Detailed Methodological Descriptions **A3**

Crop	Crop Harvest Index <sup>a</sup>	Above Ground Residue Retained after harvest	IPCC Crop Yield To Above Ground Residue Slope <sup>b</sup>	IPCC Crop Yield To Above Ground Residue Intercept <sup>b</sup>	IPCC Above To Below Ground Residue ratio
Potatoes (seed or earlies)	NA	1	0.10	1.06	0.20
Sugar beet	NA	1	1.07	1.54	0.20
Maize	NA	1	1.03	0.61	0.22
Grain maize	NA	1	1.03	0.61	0.22
Forage maize	NA	0.15	1.03	0.61	0.22
Root crops for stockfeed	NA	0.15	1.07	1.06	0.20
Leafy forage crops	NA	0.15	0.30	0.00	0.35
Other fodder crops	NA	0.1	NA	NA	0.35
Vegetables (not-differentiated)	NA	1	0.30	0.00	0.35
Vegetables (brassicas)	NA	1	0.30	0.00	0.35
Vegetables (legumes)	NA	1	0.30	0.00	0.35
Vegetables (other non-legumes)	NA	1	0.30	0.00	0.35
Other horticultural crops	NA	1	0.30	0.00	0.35
Soft Fruit	NA	1	0.20	0.00	0.35
Top Fruit	NA	1	0.20	0.00	0.35
Miscanthus	NA	1	1.00	0.00	0.35
Willow (short rotation coppice)	NA	1	1.00	0.00	0.35
Other field crops	0.52	0.5	NA	NA	0.22
Wine grapes	NA	1	0.20	0.00	0.35
Fruit (mixed top & soft fruit)	NA	1	0.20	0.00	0.35

<sup>a</sup>Where 'NA' appears in the Harvest Index column, it indicates that the IPCC 2006 method was used; <sup>b</sup>where 'NA' appears in the IPCC slope or intercept column, it means that the Harvest Index approach was used

## Other Detailed Methodological Descriptions **A3**

**Table A 3.3.13 N concentrations in above and below ground biomass**

<b>Crop</b>	<b>Below Ground N, kg N/[t DM]</b>	<b>Crop Residue Above Ground N, kg N/[t DM]</b>
Oats	8.0	5.4
Spring oats	8.0	5.4
Winter oats	8.0	5.4
Spring barley	14.0	6.7
Spring barley (malting)	14.0	6.7
Spring barley (non-malting)	14.0	6.7
Winter barley	14.0	6.7
Winter barley (malting)	14.0	6.7
Winter barley (non-malting)	14.0	6.7
Wheat	9.0	6.2
Wheat (milling)	9.0	6.2
Wheat (non-milling)	9.0	6.2
Minor cereals	9.0	6.6
Oilseed rape	11.0	9.9
Spring oilseed rape	11.0	9.9
Winter oilseed rape	11.0	9.9
Linseed and Flax	11.0	9.9
Linseed	11.0	9.9
Flax	11.0	9.9
Field beans and peas combined	8.0	8.0
Potatoes	14.0	17.3
Potatoes (maincrop)	14.0	17.3
Potatoes (seed or earlies)	14.0	17.3
Sugar beet	14.0	24.6
Maize	7.0	6.0

## Other Detailed Methodological Descriptions **A3**

<b>Crop</b>	<b>Below Ground N, kg N/[t DM]</b>	<b>Crop Residue Above Ground N, kg N/[t DM]</b>
Grain maize	7.0	6.0
Forage maize	7.0	6.0
Root crops for stockfeed	14.0	12.6
Leafy forage crops	12.0	26.3
Other fodder crops	14.0	6.7
Vegetables (not-differentiated)	12.0	26.1
Vegetables (brassicas)	12.0	38.4
Vegetables (legumes)	22.0	23.2
Vegetables (other non-legumes)	22.0	16.7
Other horticultural crops	22.0	26.1
Soft Fruit	11.0	17.7
Top Fruit	11.0	3.9
Miscanthus	11.0	0.3
Willow (short rotation coppice)	11.0	0.3
Other field crops	11.0	6.7
Wine grapes	11.0	3.3
Fruit (mixed top & soft fruit)	11.0	8.1



**A 3.3.3.2 Mineralisation**

**Table A 3.3.14 Mineralised N from soils**

	1990	1995	2000	2005	2010	2015	2020	2021
N in mineral soils that is mineralised as a result of historical land use change to Cropland (kt N/y)	38.84	49.62	63.99	75.58	81.87	83.99	82.07	81.10
N in mineral soils that is mineralised as a result of Cropland Management (kt N/y)	0.05	0.07	0.06	0.06	0.06	0.06	0.90	1.60
Direct N <sub>2</sub> O emissions from mineralised N as a result of historical land use change to Cropland, kt N <sub>2</sub> O/y	0.61	0.78	1.01	1.19	1.29	1.32	1.29	1.27
Direct N <sub>2</sub> O emissions from mineralised N as a result of Cropland Management, kt N <sub>2</sub> O/y	0.00075	0.00116	0.00098	0.00099	0.00093	0.00096	0.01414	0.02506

## Other Detailed Methodological Descriptions **A3**

	1990	1995	2000	2005	2010	2015	2020	2021
Indirect N <sub>2</sub> O emissions from mineralised N as a result of historical land use change to Cropland and Cropland management (kt N <sub>2</sub> O/y)	0.14	0.18	0.23	0.27	0.29	0.30	0.29	0.29
Total N <sub>2</sub> O emissions from Mineralisation (kt N <sub>2</sub> O/y)	0.75	0.96	1.23	1.46	1.58	1.62	1.60	1.59

### A 3.3.3.3 Histosols

**Table A 3.3.15 N<sub>2</sub>O emissions from drained organic soils**

	1990	1995	2000	2005	2010	2015	2020	2021
Area of histosols – Cropland, ha	197,352	196,205	195,091	193,304	191,775	190,422	189,123	188,863
Area of histosols - Intensive grassland, ha	194,972	191,047	187,343	184,336	182,458	181,160	179,951	179,716
Direct N <sub>2</sub> O emissions from histosols - Cropland, kt N <sub>2</sub> O/y	5.05	5.02	4.99	4.94	4.91	4.87	4.84	4.83
Direct N <sub>2</sub> O emissions from histosols – Intensive grassland, kt N <sub>2</sub> O/y	2.26	2.22	2.18	2.14	2.12	2.10	2.09	2.09
Total N <sub>2</sub> O emissions from histosols, kt N/y	7.31	7.24	7.17	7.09	7.02	6.97	6.93	6.92

## Other Detailed Methodological Descriptions **A3**

### A 3.3.3.4 Atmospheric deposition of NO<sub>x</sub> and NH<sub>3</sub>

**Table A 3.3.16 Amount of N that is volatilized from agricultural inputs and associated N<sub>2</sub>O emissions**

	1990	1995	2000	2005	2010	2015	2020	2021
Amount of volatilized N, kg/yr	137,015,630	127,588,482	122,619,448	116,722,828	113,506,950	124,869,793	117,853,013	120,376,101
Total N <sub>2</sub> O emissions from volatilized N (kt N <sub>2</sub> O/y)	3.01	2.81	2.70	2.57	2.50	2.75	2.59	2.65

### A 3.3.3.5 Leaching and runoff

**Table A 3.3.17 Amount of N fertilizers and other agricultural inputs that is lost through leaching and run-off and associated N<sub>2</sub>O emissions**

	1990	1995	2000	2005	2010	2015	2020	2021
Amount of N lost through leaching and runoff, kg/yr	541,000,016	518,802,948	524,100,913	490,809,839	483,500,859	508,847,351	440,759,884	467,175,174
Total N <sub>2</sub> O emissions from N lost through leaching and runoff, kt N <sub>2</sub> O/y	6.38	6.11	6.18	5.78	5.70	6.00	5.19	5.51

### A 3.3.4 Liming

**Table A 3.3.18 Amount of limestone and dolomite applied to soils and associated CO<sub>2</sub> emissions**

	1990	1995	2000	2005	2010	2015	2020	2021
Amount of limestone applied to soils, t/yr	1,632,538	1,350,922	1,386,120	2,603,325	2,366,733	1,942,627	2,205,401	2,392,724
Amount of dolomite applied to soils, t/yr	625,385	665,824	456,362	492,982	481,331	343,255	308,198	257,385

## Other Detailed Methodological Descriptions **A3**

	1990	1995	2000	2005	2010	2015	2020	2021
Total CO <sub>2</sub> emissions from application of limestone (kt CO <sub>2</sub> /y)	718	594	610	1,145	1,041	855	970	1,053
Total CO <sub>2</sub> emissions from application of dolomite (kt CO <sub>2</sub> /y)	298	317	218	235	229	164	147	123

### A 3.3.5 Urea application

**Table A 3.3.19 Amount of urea applied to soils and associated CO<sub>2</sub> emissions**

	1990	1995	2000	2005	2010	2015	2020	2021
Amount of urea applied to soils, t/yr	399,483	243,280	194,039	254,642	349,229	478,591	318,586	343,760
Total CO <sub>2</sub> emissions from application of urea (kt CO <sub>2</sub> /y)	293	178	142	187	256	351	234	252

### **A 3.3.6 Distribution of manure in different management systems**

A review of the literature on livestock housing and manure management practices conducted by Ken Smith (ADAS) as part of Defra project AC0114 (Smith, 2012), updated with survey data on manure spreading practices from the British Survey of Fertiliser Practice<sup>15</sup>, and data provided directly by DAERA statistics for Northern Ireland (Peter Cottney, pers. comm.) was used as the basis for developing the 1990 to 2021 timeseries of livestock housing and manure management practices for each country (England, Wales, Scotland and Northern Ireland) from which a weighted average was derived for the UK.

Detailed practice-specific data are applied at a country scale for each livestock category for the livestock housing, manure storage and manure application phases of the manure management continuum. Estimates for these activity data across the timeseries are derived from a number of routine and ad-hoc surveys including the Defra Farm Practices Surveys<sup>16</sup> and published manure management surveys (Smith et al., 2000, 2001a, 2001b). Tonnages of poultry litter incinerated in each year were obtained directly from MREL<sup>17</sup>, with tonnage exported from Northern Ireland to be incinerated in Scotland and England provided by DAERA.

Quantities of livestock manure being used in anaerobic digestion (Table 5-7) are estimated from data provided by the National Non-Food Crops Centre<sup>18</sup> annual deployment report, a database listing operational, under-construction and proposed anaerobic digestion plants in the UK. Information in the database includes location, capacity, feedstock (inputs) types and feedstock quantities in five categories: manure, crops, crop wastes, food and other. Although co-digestion of two or more feedstocks is commonly practiced, for the purpose of the emission calculations each is treated individually. Manure as a feedstock is further categorised as cattle, pig, poultry, equine and miscellaneous animal.

For inventory calculations, the categories of equine and miscellaneous animal (i.e. not specifically identified) are summed and reallocated to cattle, pig and poultry based on the relative proportions of total manure (leaving housing) for those livestock types. Similarly, as cattle is not further defined, the relative proportions from the dairy and beef sectors are assumed to be in proportion to the total quantity of manure managed for those sectors. Within each livestock sector, for each livestock subcategory, the same proportions are applied to manure quantity going to anaerobic digestion as are applied to that sector as a whole. For cattle and pigs, slurry and farmyard manure are assumed to be equally applicable for anaerobic digestion, so have the same proportional implementation.

Within the sheep sector, all (100%) manure from the ewe housing period is managed as solid farmyard manure with additions of straw bedding. All (100%) manure from the housing period is stored for a period of several months as a field heap on grass before spreading to land. Therefore, there is a nitrate leaching loss from all stored sheep manure (estimated according to the measurements of Nicholson et al., 2011) and there is no need to assume that leachate from manure heaps stored on concrete pads is collected and managed differently. Based on Roderick (2001) survey of 2,649 flocks managed by members of the National Sheep Association from across the United Kingdom, the inventory calculations assume that 75% of ewes associated with lowland systems, 60% with upland systems, and 40% with hill systems

---

<sup>15</sup> Most recent BSFP: <https://www.gov.uk/government/statistics/british-survey-of-fertiliser-practice-2019>

<sup>16</sup> Defra Farm Practices Surveys: <https://www.gov.uk/government/collections/farm-practices-survey>

<sup>17</sup> Melton Renewable Energy Ltd., formerly EPRL: <https://www.mreuk.com/>

<sup>18</sup> National Non-Food Crops Centre: <https://www.nnfcc.co.uk/>

are housed in the last weeks of pregnancy. From the same survey, we assumed that housed breeding ewes are housed for 42 days prior to lambing, and that neither the ewe nor new-born lamb are housed post lambing. Further detail on management housing for other activities (e.g. shearing) were obtained from a postal survey of 697 farms in England and Wales (Defra, 2004; Dauven and Crabb, 1998; Webb et al., 2001).

### **A 3.3.7 Description of the UK Agriculture Inventory Model**

The agriculture inventory model was developed as part of the Defra funded Improvement Programme in order to meet the range of UK Government reporting and policy evidence requirements, and to enable the UK to meet international and national reporting obligations and mitigation targets across GHGs and air quality pollutants.

#### **A 3.3.7.1 International Conventions**

The primary purpose of the UK agriculture inventory model is to produce annual inventories of ammonia (NH<sub>3</sub>) and GHG (nitrous oxide, N<sub>2</sub>O; methane, CH<sub>4</sub>; and carbon dioxide, CO<sub>2</sub>) emissions from all UK agricultural sources in compliance with international inventory methodological and reporting guidelines. The methods deployed in the model are consistent with the IPCC guidelines for national GHG inventories and the EMEP-EEA guidance for air pollutant emission inventories.

The inventory model and system has been developed under contract to the UK Department for Environment, Food and Rural Affairs (Defra) and is operated in co-ordination with the UK's Inventory Agency to the Department for Energy Security and Net Zero (DESNZ) which is the UK's designated Single National Entity under the UN Framework Convention on Climate Change (UNFCCC).

The agriculture inventory model outputs are designed to meet the UK's international reporting obligations under several conventions, including the reporting of GHG emissions under the UNFCCC Reporting Guidelines and to the Kyoto Protocol, and reporting of air pollutant emissions under the Gothenburg Protocol. Ammonia emissions are reported under the Convention on Long-Range Transboundary Air Pollution (CLRTAP) and the National Emission Ceilings Regulation (NECR).

#### **A 3.3.7.2 National and Sub-national Commitments**

In addition to the international reporting outputs, the agriculture inventory model delivers emission inventory and projections data as underpinning evidence for use within national and sub-national reporting, progress/target-tracking and policy development, including to track emissions against UK national GHG targets and carbon budgets, Devolved Administration (DA) GHG targets and budgets, and Local Authority (LA) level datasets. The same data, assumptions and methods that are used for UK national inventory compilation and reporting are also used to inform the DA inventories (GHG and AQ) as well as Local Authority GHG inventories. Further, the agriculture inventory outputs include detailed emission maps for across the UK, in particular to support air quality modelling to assess the sources and impacts of ammonia (NH<sub>3</sub>) emissions. This integrated approach ensures that where better data or information (e.g. regarding local farm practices, uptake of mitigation measures) becomes available, the subsequent improvement in method accuracy to better-reflect local circumstances also ripples through all of the sub-national to national inventory datasets.

This wide range of reporting and policy evidence requirements has informed the design and scope of the UK agriculture model, and indeed continues to shape the evolution of the UK agriculture model, through improvements to refine inventory data and methods in order to address ever-increasing demands for more detailed, accurate GHG and ammonia (NH<sub>3</sub>) data, at a higher level of resolution (e.g. per region/locality, per livestock or crop sub-category, per waste management stream, per mitigation action and so on).

The inventory outputs are applied within analytical tools across Government, including the Defra Scenario Modelling Tool (SMT) which enables policy analysts to test mitigation strategies as the UK seeks to achieve National Emission Ceiling Reduction targets in 2030 and beyond for ammonia (NH<sub>3</sub>) alongside developing Net Zero GHG pathways for the sector in each region of the UK.

### **A 3.3.7.3 National and Local Circumstances**

The model is designed to be sensitive not only to changes in key activity data such as livestock numbers and crop areas, but also to changes in UK farming practices and the uptake of mitigation measures, and at a local level to reflect local (i.e. not “average national”) circumstances.

The UK agriculture inventory model is structured to enable representation of the key underlying driving variables of the GHG and ammonia (NH<sub>3</sub>) emissions, including soil types, climate, livestock and cropping characteristics and farm management practices including the uptake of specific mitigation methods. Cross-cutting analysis of the UK agriculture sector, using farm survey data, seeks to identify farms by type within a 10x10km grid square; this includes characterisation of the farms according to the primary sources of economic income (e.g. arable, sheep, dairy, poultry, mixed) and whether the farm location (e.g. remote upland) is within a less favoured economic area. This initial analysis then informs some of the assumptions applied in the source-specific inventory methods, for example regarding production systems and waste management practices, the technology and mitigation techniques that are most commonly deployed per farm type, the likely level of investment in fertiliser use and so on.

The model also includes detailed representation of uncertainties consistent with the UK inventory-wide uncertainty analysis, in order to highlight and prioritise opportunities for future improvement.

### **A 3.3.7.4 Scope: Territories, Sources, Pollutants, Years**

Note that the UK Agriculture Inventory as described in this document covers all of the agriculture sector emission estimates from sources **in the UK only** (i.e. England, Wales, Scotland and Northern Ireland); it does not generate emission estimates from the agriculture sector in the UK Crown Dependencies (CDs), i.e. Jersey, Guernsey and the Isle of Man, nor in the UK Overseas Territories (OTs), which include the Falkland Islands, Bermuda, the Cayman Islands, the Virgin Islands, Montserrat and Gibraltar. The development of evidence through field trials and subsequent development of higher-Tier methods have been focused on the UK territory alone, and to use UK national statistics and other sector data to deliver high quality emission estimates.

The GHG and air quality pollutant emission estimates for CDs and OTs are based on much more limited activity data and evidence, applying simpler methods, often IPCC Tier 1 methods (i.e. applying default Emission Factors). As such the CD and OT emission estimates are associated with higher uncertainty, but these simpler methods reflect the much lower levels of activity and emissions in CDs and OTs compared to the UK, and the lower level of evidence to inform higher-tier methods, such as EFs that reflect local circumstances in the CDs and OTs.

The agriculture model does not generate emission estimates from fuel combustion in the sector, neither in stationary sources nor in mobile machinery. These fuel combustion emission sources are reported under the Energy sector of the UK inventory, with methods described in the National Inventory Report and Informative Inventory Report for GHG and air quality pollutants respectively. The data and methods applied are consistent with IPCC and EMEP-EEA Energy sector inventory guidance, applying country-specific or default EFs to the activity data that are available from UK energy statistics. The agriculture model described here generates the emission estimates from sources that are as described within the AFOLU volume of the IPCC inventory guidance, i.e. from livestock sources (enteric fermentation; waste management) and crop sector sources (agricultural soils emissions including from fertiliser use, liming and urea applications; field burning).

The agriculture inventory model also does not cover the emission sources and sinks from changes in soil carbon stocks and GHG emissions associated with specific land management or land use changes; these are estimated and reported in the LULUCF section of the UK GHG inventory. Further the agriculture sector model does not cover pre- or post-farm gate GHG emissions associated with agricultural operations (e.g. fertiliser manufacture, processing of livestock feeds, transport and processing of foodstuffs, etc.). Such emissions, where they occur in the UK, are accounted for in other sections of the UK GHG inventory (e.g. Energy, Industrial processes) and are not broken down in sufficient detail as to allocate them specifically to the agriculture industry; emissions from the production of fertilisers / feeds etc. that are imported for use in the UK are reported within their country of origin.

The scope of pollutants reported is described per emission source throughout this document and comprises GHGs (N<sub>2</sub>O, CH<sub>4</sub>, CO<sub>2</sub>) and air quality pollutants including ammonia (NH<sub>3</sub>), oxides of nitrogen (NO<sub>x</sub>) and non-methane volatile organic compounds (NMVOCs).

Consistent with the international reporting requirements, the UK inventory time series of emission estimates that are generated through the agriculture model are focused on annual emission estimates from 1990 to the latest year for which data are available. In the UK, the Base Year for GHGs (excluding F-gases) under the UNFCCC is 1990, whilst the Base Year for air quality pollutant targets under NECR is 2005. The UK inventory does also continue to develop longer-term trend estimates, including of ammonia (NH<sub>3</sub>) emissions from 1970 onwards but the data quality and resources applied to those earlier years is such that they should be regarded as indicative only.

### **A 3.3.7.5 Summary of the Model Structure**

The model structure and data flows are described in detail later in this Annex, but in summary the core engine of the model is written in C# language using stored queries, calling on an SQL server database which contains all of the pre-processed Activity Data and Emission Factor data per source category. The coded model comprises the calculations for all major emission sources of the agriculture sector in the UK, with a separate calculation module developed for each source. The code per source draws on source-specific input activity tables that hold input data at a high level of disaggregation, including geo-referencing. The model generates source-specific output tables per 10 by 10 km grid cell which can be aggregated according to the required reporting taxonomy such as the IPCC Common Reporting Format (CRF) tables for GHGs, Nomenclature for Reporting (NFR) tables for ammonia (NH<sub>3</sub>) and other air quality pollutants, for UK national statistics or for reporting against UK, DA, LA targets, including for:

- enteric methane from livestock;
- manure management methane and nitrous oxide emissions from livestock types: dairy, beef, sheep, swine, poultry, goats, horses and deer;
- direct and indirect nitrous oxide emissions from synthetic N fertiliser, organic N (e.g., animal manure, sewage sludge and digestate) applied to grassland and arable crops, and crop residues;
- nitrous oxide emissions from urine and dung N deposited on pasture from dairy and beef cattle, sheep, swine, poultry, goats, horses and deer.

Activity data are collated, and calculations are performed per year from 1990 to the latest inventory year, per source category, per farm type, at a 10 by 10 km grid cell resolution; the results are aggregated across the four constituent countries (England, Wales, Scotland and Northern Ireland) to derive UK totals. The choice of grid size reflects uncertainty in agricultural holdings that are variously geo-referenced by parish, holding office or field centroids, but is principally justified by the confidentiality restrictions placed on the mapping of inventory input and output datasets.



The high level of data resolution per grid cell, per farm type enables the UK agriculture inventory model to perform emission estimation calculations bottom-up to reflect local parameters such as climate (long term temperature, rainfall) and soil type, as well as modelling the farm management practices that reflect the economic status per farm type and local farm survey responses. The aggregation of data (e.g. livestock numbers, fertiliser use, crop production) by farm type across a 10 by 10 km grid ensures that data for specific farm holdings are not outputted, to protect commercially sensitive raw data in line with statutory data protection obligations.

Outside of the scope of the model are the nitrous oxide emissions from mineralisation and histosols and carbon dioxide emissions from liming and the application of urea to soils; these source categories in the UK inventory are estimated using Tier 1 methods, within MS Excel spreadsheet models. They are not derived “bottom-up” within the main UK agriculture model but are estimated for UK-wide emissions per source.

### **A 3.3.7.6 Data Security**

The UK agriculture inventory data management and reporting is conducted in accordance with the requirements of prevailing legislation, including the General Data Protection Regulation (GDPR). In the context of the inventory data and methods, under GDPR there must be no public data disclosure of data pertaining to an individual farm holding. The procedures for handling of holding-level data from farm surveys are agreed via agreements with the data owners. Holding level data are not shared around the agriculture inventory consortium, to minimise risk of accidental data release. Task owners hold the raw survey data on secure servers. Data are processed, checked and then aggregated (e.g. to per grid cell, pre RFT type) prior to distribution to sector leads for source-specific data QC and calculations. The aggregated inventory outputs ensure that activity or emission estimates from individual holdings cannot be isolated even in the most detailed mapping outputs.

### **A 3.3.7.7 Design, development, acceptance, verification and validation of the UK model**

The UK agriculture inventory model is bespoke in design, tailored to UK-specific data availability and resolution, the latest scientific understanding that reflects UK circumstances (e.g. soils, climate), production systems and farming practices. Consistent with inventory good practice guidance, the methods for key source categories (i.e. those sources that contribute most to the level or trend of inventory estimates) are higher-Tier methods that apply UK-specific emission factors, whereas minor sources are estimated using simpler methods where international default factors are applied; this approach is proportionate and efficiently minimises the overall uncertainty of sector estimates.

The methods are developed to represent UK territorial emission sources and do not cover agricultural sources in Crown Dependencies nor Overseas Territories; methods for these territories are simpler, typically Tier 1, reflecting their low level of emissions compared to UK and that detailed activity data and information on local farming practices/conditions are scarce for these territories.

The model was developed to accommodate scientific research findings from an extensive programme of UK field studies, following a significant investment over several years by Defra, via the GHG Research platform<sup>19</sup> which led to numerous published research papers to establish the best source methods and UK emission factors to accurately reflect emissions on UK farms. The UK Climate Change Act 2008 and the associated Carbon Budgets process motivated a major investment in the inventory compilation and accounting system to ensure that it was fit for purpose. Critically the objective was to ensure the UK's GHG inventory accurately reflects the

---

<sup>19</sup> <https://randd.defra.gov.uk/ProjectDetails?ProjectID=17179>

unique structure of the UK industry, and that progress made by farmers to improve production efficiency was adequately captured in the calculations. The work supported comprehensive measurements of UK livestock and soils emissions, gathering pre-existing academic and industry data sets and combining with bespoke additional measurements to fill knowledge gaps. The higher-tier inventory methods are based upon:

- Around 150 site-years of data over a range of soil types, climates, fertiliser regimes and management strategies
- Around 3,400 existing records plus 5,600 new measurements of methane emissions from ruminant livestock complete with data on diet, management etc.
- All data collection was audited and calibrated by the UK's National Physical Laboratory

This UK dataset constitutes one of the largest single databases of agricultural emissions measurements collected globally and has been used as a source of data to revise the IPCC's standard emissions factors for livestock. Throughout the development process Defra engaged a stakeholder group of industry representatives to steer the programme. This included significant provision of expertise and data to underpin the inventory method development.

The inventory improvement programme focussed on those areas of the inventory with largest uncertainties, and those that had been recommended by previous Expert Review Teams to convert to higher Tiers. The implementation of the model was initiated in 2016, with the code developed and extensively tested per source method via an iterative process of code development including unit testing of code sections, validated against separate calculations performed in MS Excel by the team of UK sector experts, i.e. via extensive reperformance testing. Through this process the model has been extensively tested and calibrated against the results from field trials and other research. Further, in the development and acceptance of source-specific methods, prior to their implementation within the UK inventory, the method publications were peer-reviewed by leading UK academics, and subsequently several key category methods have been subject to bilateral reviews with inventory experts from countries with similar climatic conditions and farming practices, including from France, Ireland and Germany.

Limitations of the current model, aside from the geographical limits indicated above, include that for several source methods the algorithms have been developed such that the impacts of specific mitigation measures will be represented in the outputs, however there are (in some cases) scarce data on the national uptake of these measures and limited information on the impacts of mitigation measures. Therefore, some of the model code is currently latent, awaiting the development of improved data streams to inform mitigation uptake and impacts across the UK. Mitigation actions represented in the inventory model are described later in this Annex, as one of the key data inputs to the modelling. In addition, the temporal resolution of the modelling is limited although several of the source category methods do use activity data that are available at monthly intervals in order to improve accuracy:

- ✓ Beef and dairy cattle numbers vary across the year, and these are reflected in the modelling with calculations performed at monthly resolution;
- ✓ Emissions from fertiliser application are based on monthly estimates of fertiliser use, in order to reflect the climatic conditions (and their impact on emissions), especially during Spring.

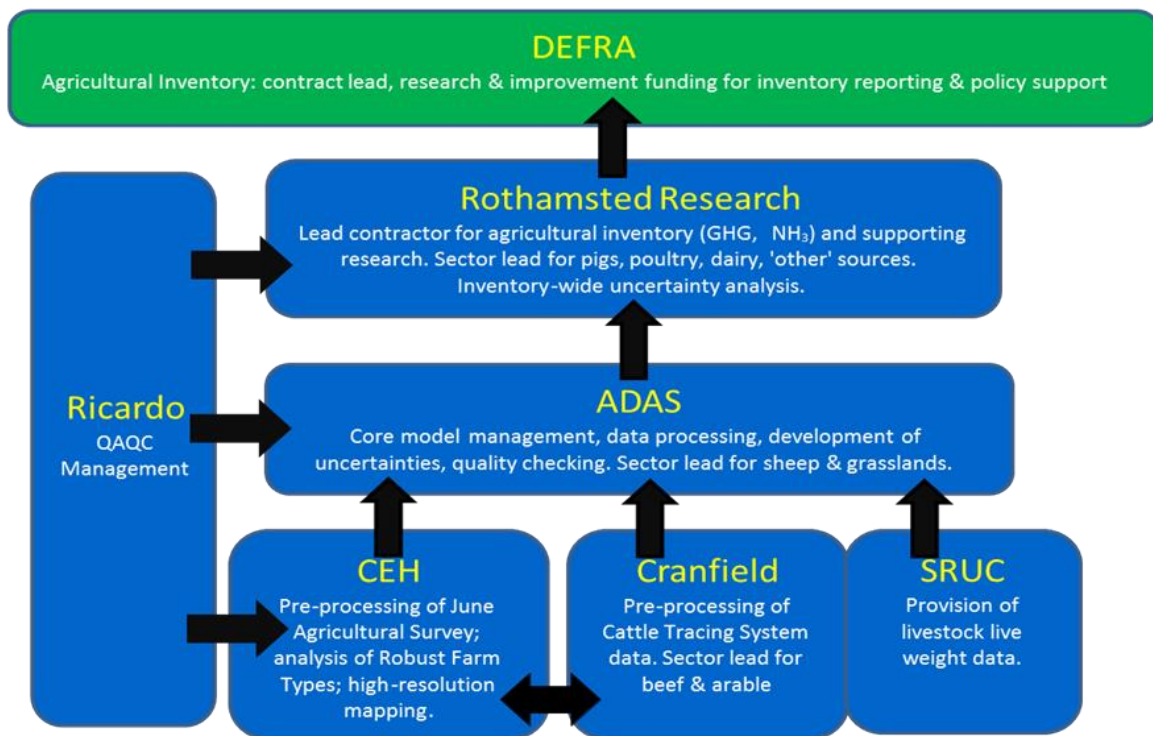
The model is designed and built for use (updates and analytical runs) by experienced domain experts with an understanding of the sector and also the modelling framework. In order to enable other stakeholders to access the detailed outputs from the agriculture inventory model, user-friendly outputs and interfaces have been developed, such as the Output Viewer software (*described later in this Annex*) which is made available to Defra and DA inventory and policy leads for the agriculture sector.

Sections later in this Annex set out the key data sources, the pre-processing of survey data and then the details of each source method including the activity data, assumptions and emission factors, and the level of resolution in the method implementation, e.g. livestock age ranges, breed types, farm types and so on. Where appropriate, links are provided to key publications to present further details.

### A 3.3.7.8 Governance: Roles and Responsibility

The agriculture inventory work programme is managed and funded by **Defra**, as the UK Government Department with policy responsibility for farming, food and rural affairs. Defra contracts out the delivery of the inventory via a competitive tender process, typically every 3-4 years. The agriculture inventory is currently (@2023) produced by a consortium of organisations, led by **Rothamsted Research** (RRes). The roles and responsibilities of key organisations are summarised below.

**Figure A 3.1 UK Agriculture Inventory: Organisational Roles and Responsibilities**



**Defra** as the overall management lead is the inventory Commissioner and Approver. The **Rothamsted Research** project manager is the overall inventory Lead Analyst, with other sector experts in **ADAS**, **Cranfield University**, **SRUC** and **UKCEH** acting as Lead Analyst for individual sectors. **Ricardo** has an over-arching QAQC role across the consortium, acting as the Assurer.

Other key stakeholders associated with the agriculture inventory are **DESNZ** as the UK GHGI Single National Entity and two steering groups that UK Government has established to manage inventory improvements and sign-off, and oversee the development of scientific, technical,

modelling and policy evidence components of the UK Inventories: the **National Inventory Steering Committee** (NISC, for GHGs) and the **Air Quality Inventory Steering Committee** (AQISC, for air quality pollutants). These steering groups include representation from across UK Government Departments, from the Devolved Administrations of Scotland, Wales and Northern Ireland, and from other agencies and organisations, industry, academia and local government.

The outputs from the agriculture inventory complement the work in other sectors to generate comprehensive UK inventories of anthropogenic emissions to atmosphere for GHGs and air quality pollutants, for onwards reporting to the UNFCCC, UNECE and other international organisations. Where necessary to ensure internal consistency, the agriculture inventory experts liaise directly with the inventory compilers of other sectors including for Land Use, Land Use Change and Forestry (LULUCF) and Waste Management.

### **A 3.3.7.9 Inventory Model Background: Development of UK Evidence**

The UK agriculture inventory system has been developed over a decade of investment in field trials, desk-based research and new modelling methods by Defra and the DA governments. The investment in UK scientific understanding and method development was initiated through the Agricultural GHG Inventory Research Platform, via a large consortium of UK academic and research organisations in three projects led by Rothamsted Research (N<sub>2</sub>O inventory improvement), IBERS (CH<sub>4</sub> inventory improvement), and ADAS (Data mining) under contract to Defra, starting in 2010.

The UK Government investment has substantially improved the UK-specific emissions evidence base, leading to development of new higher Tier UK-specific calculation methodologies, emission factors and sector representation in the inventory emission estimates for the agriculture sector. The inventory development programme culminated in the development of a bespoke agriculture inventory model with a fully revised structure to enable representation of the key underlying driving variables of the GHG emissions, including soils, climate, livestock and cropping characteristics and farm management practices including the uptake of specific mitigation methods. The model also includes detailed representation of uncertainties, allowing full uncertainty analyses to highlight areas for future improvement. The UK inventory undergoes continuous improvement to reflect developments in source data and scientific understanding, for example when inventory guidance is updated to improve methods, new AD or EFs become available, or to add new emission sources and/or to reflect new mitigation actions or changes to UK farming practices.

Key Links:

- AC0114: <https://randd.defra.gov.uk/ProjectDetails?ProjectID=17179>
- AC0115: <https://randd.defra.gov.uk/ProjectDetails?ProjectID=17180>
- AC0116: <https://randd.defra.gov.uk/ProjectDetails?ProjectID=17181>
- SCF01012: <https://randd.defra.gov.uk/ProjectDetails?ProjectID=18677>

### **A 3.3.7.10 Rationale for Agriculture Inventory Model Design**

The UK agriculture inventory model was designed to meet the UK and sub-national reporting and policy requirements, to provide industry sector-specific emission estimates and to account for the impact of changing management practices within the industry on emission estimates. The UK has therefore developed a combination Tier 2 and Tier 3 approaches for all key emission categories, in which country-specific soil and climatic conditions, management practices and emission factors are all considered in the emission calculation. The inventory methods include, for livestock systems, a nitrogen mass-flow approach that accounts for nitrogen losses and transformations from the point of excretion by the animal through the manure management continuum, application to soil and the relevant losses to the atmosphere and water courses.

The model is designed to enable the inventory calculations to be performed at the level of 10 by 10 km grid squares in order to improve accuracy (through more accurate representation of local conditions of climate, soil type etc.) and sensitivity to changes in local activity data (livestock numbers, areas of grassland and crop production) and local management practices and mitigation uptake (where data allows). The sum per source category across all of the 10 by 10 km grid squares is then aggregated to deliver devolved country (i.e. England, Scotland, Wales and Northern Ireland) and UK inventory totals.

The total crop areas and livestock numbers are spatially disaggregated on a fixed regular grid of 10 by 10 km cells covering the terrestrial area of the United Kingdom. There are 3,040 terrestrial cells that are aligned with the Ordnance Survey National Grid for Great Britain with an origin at the south-west corner of the cell located 400 km west and 100 km south of 49°N 2°W. Each grid cell is assigned a unique number (CELL). The reference grid excludes the islands of Jersey, Guernsey and the Isle of Man.

The indexed crop areas and livestock numbers are also disaggregated by 'Representative Farm Type' (RFT) that is aligned to the MAFF (1993) methodology for defining 'Robust Farm Types' that are based on the farm enterprise that contributes the majority (more than two thirds) of an estimated business 'Standard Output' (SO), based on surveyed crop areas and livestock numbers and standard output coefficients. There are ten representative farm types (Cereal, General Cropping, Horticulture, Pig, Poultry, Less Favoured Area Cattle and Sheep, Lowland Cattle and Sheep, Dairy, Mixed, and Other).

The total crop areas and livestock numbers are disaggregated by 'Sector Type' that are aligned to the generic crop (Crop and Grass) and livestock (Beef, Dairy, Sheep, Pig, Poultry and Minor) types reported in the UK inventory. Each sector is represented by one or more 'Item Type' that are the specific crop and livestock types. For example, the sheep sector is disaggregated between ewes, rams and lambs.

More detailed data resolution has been implemented for specific source categories to further enhance method accuracy.

**Dairy example:** For example to improve the representation of dairy production systems, within each grid cell the livestock numbers are derived on a monthly basis for a series of production systems and sub-systems including: dairy cows and heifers (productive animals following their first calving); Dairy heifers in calf (previously non-lactating animals, in calf for the first time); Dairy replacements (all young animals > 1 year which are being kept as replacements for the milking herd); Dairy calves (all calves < 1 year which will go on to become dairy replacements); Dairy bulls (bulls kept on dairy farms).

Within each spatial cell and system/sub-systems described above, certain production parameters will be associated with the particular livestock sub-category at a monthly resolution for a given year. For example, for dairy cows and heifers the parameters required will be calving time, mean daily milk yield, mean milk fat content, mean milk protein content, mean live weight, mean weight gain (or loss) and mean pregnancy rate (the proportion of mature females that will go through gestation in a year). For dairy heifers in calf, the same parameters will be required excepting mean daily milk yield and fat content, and for the other categories the same parameters excepting mean milk yield and fat content and mean pregnancy rate. Additional data needs will also include transfers from the dairy to beef herd (e.g. dairy cows that still support beef calf production).

Local holding survey data and assumptions on management practices per RFT in a given grid cell are used to assign calculation parameters that reflect housing and manure management practices, for example to reflect dairy cattle housed on slurry-based or a litter-bedded loose housing system. The proportion of dairy cattle within each system/sub-system/category associated with each housing type on an annual basis is required for each year as is the proportion that has access to an outdoor collecting or feeding yard.

Within each spatial cell, the areas of grassland for grazing and silage production and the areas of other forage crops associated with dairy production are required, together with a monthly breakdown of amount of fertiliser nitrogen applied, by fertiliser type. The extent to which any fertiliser additives are used (e.g. urease or nitrification inhibitors) may also be modelled, subject to data availability.

*The dairy examples are presented to describe the model design; full details of the data and methods per source category are described within the National Inventory Report.*

The level of disaggregation permits different assumptions to be applied within the inventory methods across the agricultural sector, for example to take account of the different economic circumstances (e.g. farms within Less Favoured Area status) which may determine the typical management practices, level of investment in mitigation action uptake. The allocation of farms to RFTs also enables the modelling to take account of different practices that are expected, e.g. for the waste management and housing options of cattle on a predominantly beef or dairy or mixed farm type.

Regarding the emissions from agricultural soils, the spatial resolution of the model combined with the parameters held in the physical database (*see the Raw Data Inputs section of this Annex for details*) enable the climatic conditions (rainfall, temperature), soil types and elevation per grid cell to be considered, where appropriate, within calculations to estimate nitrous oxide and ammonia emissions.

The model is designed to perform calculations per year and per country (England, Wales, Scotland, Northern Ireland) at a 10 by 10 km grid resolution, calling on the underlying data for that grid square of climate, soil, farm types, as well as reflecting different production systems and mitigation actions (from survey information, where available) and fertiliser applications by type. All these localised datasets result in localised EFs per source category-pollutant; these are then aggregated across regions / areas, e.g. per Local Authority, per devolved Country, for the UK as a whole. The resultant dataset exhibits region-specific EFs and is sensitive to local information on e.g. uptake of mitigation actions or changes to production and management systems.

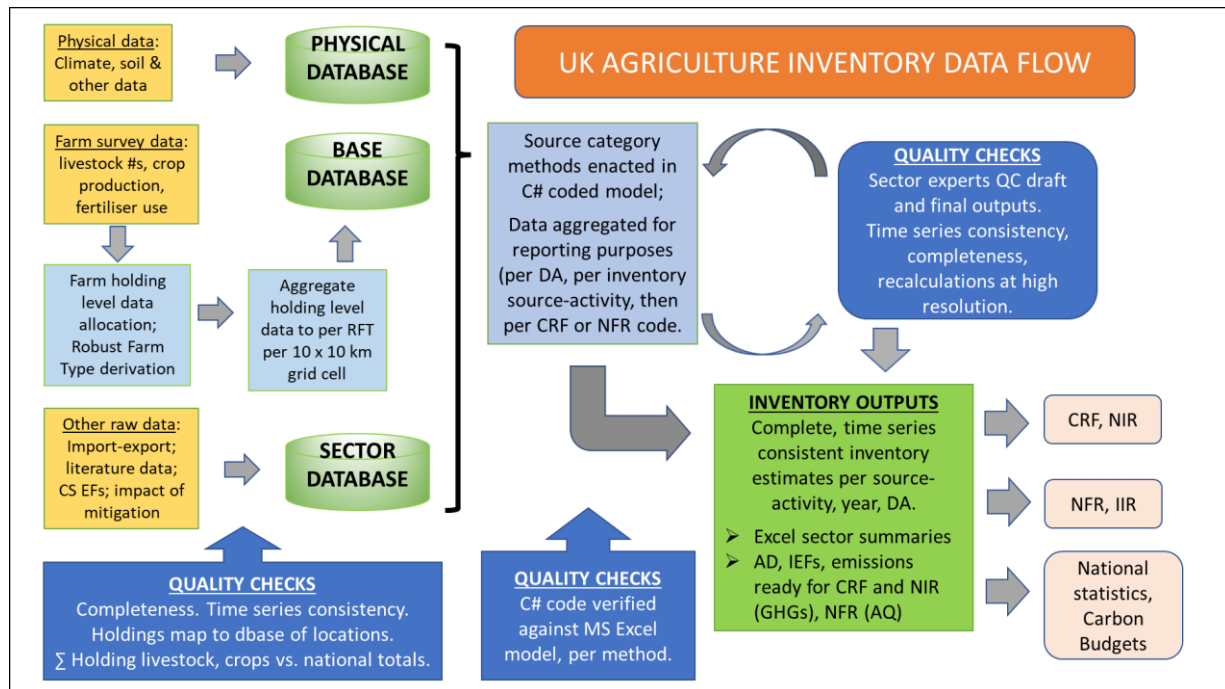
### **A 3.3.7.11 Overview of the Agriculture Inventory Model Data Flow**

This section describes the UK agriculture data flow through:

- Raw data inputs
- Pre-processing
- Compilation of activity data tables per source category
- Core model calculations, within the C# model
- Outputs, expert review, inventory finalisation

*The schematic below provides an overview of the whole process; more detailed flow charts are presented throughout this section.*

**Figure A 3.2 Inventory Model Data Flows: Overview of the Full Process**



The UK agriculture inventory compilation and reporting cycle is compressed into a relatively short time-window each year. This is necessitated by the fact that the key year “n” data that are required for the annual updates typically only become available during June-July in year “n+1”, and the UK Government time-table for reviewing and signing off the finalised inventory data for statistical releases and to underpin international reporting outputs requires that final data are ready for the Autumn NISC meeting, typically around the 3<sup>rd</sup> week in November; prior to that date, the agriculture inventory data (together with all documentation of data references, reasons for recalculations and so on) must be provided to the UK Inventory Agency to combine with the other sector data, for the purposes of overall UK inventory analysis, checking and preparation of reporting outputs.

The typical time-table for the compilation is illustrated below.

**Table A 3.3.20 Agriculture Inventory Annual Compilation Time-table**

Month (Year n+1)	Inventory Compilation Activity
April, May	Data requests sent out; data supply / GDPR agreements revised and updated between the inventory team and key data providers. JAS/C and CTS datasets may be received during these months.
June	<b>CPH data inputs updated</b> , where necessary, for use within CTS processing (UKCEH) <i>UKCEH check and update the CPH data; send to Cranfield when finalised.</i> <b>CTS data cleaning, pre-processing.</b> (Cranfield) <i>Cranfield aim to deliver draft processed CTS data for year n, by end of June.</i>
July	<b>CTS data quality checks</b> , conducted by sector experts. (Rothamsted, ADAS and UKCEH) <i>Any outliers, gaps are flagged, revised, CTS data updated by Cranfield.</i> <b>Dairy sector data</b> prepared, checked and sent to UKCEH (by mid-July) to enable the RFT allocation to be conducted. (Rothamsted)

Month (Year n+1)	Inventory Compilation Activity
	<p><b>Data processing of the JAS/C</b> and finalised CTS to conduct the <b>RFT allocation</b>, complete all <b>location and LFA datasets</b> (UKCEH)  <i>UKCEH aim to complete all of the JAS/C and RFT data processing by the end of July.</i></p> <p><b>BSFP detailed database of survey responses</b> typically provided by mid-July. (Defra)  <i>ADAS pre-processes and QCs the BSFP data, re-stratifies the BSFP data to generate more accurate GB fertiliser use data for year n, based on actual holding level response rates.</i></p>
August	<p>Prepare and load <b>Base database tables</b> (ADAS)  <i>ADAS aims to complete this task over late July / early August.</i></p> <p>Preparation of <b>all sector Activity Data tables</b> (All sector leads: Rothamsted, ADAS, Cranfield)  <i>All sector data aim to be prepared by mid-August to enable QC and first model runs to follow.</i></p> <p>All initial C# model runs, <b>output draft sector data</b> (ADAS)  <i>ADAS aims to run, QC and circulate draft results by the end of August.</i></p>
September	<p>Sector expert <b>quality checking of draft model outputs</b>. (All sector leads: Rothamsted, ADAS, Cranfield), including cross-sectoral QC with other UK Inventory Agency teams, including: crop and grassland areas per DA vs LULUCF; sewage sludge spreading data vs waste sector; poultry litter fate QC vs energy sector.  <i>Any errors, gaps, outliers are checked, justified or corrected and Activity Data tables updated, model code re-run as required to finalise the data per source category-pollutant.</i></p> <p><b>NAEI output file preparation</b> (Rothamsted)  <i>Once all sector data are finalised, Rothamsted generate aggregated outputs in inventory-ready formats, for integration by the UK Inventory Agency into the UK inventory for all sectors.</i></p> <p><b>Sector documentation: methods, recalculations, references, explanation of trends</b> (All sector leads: Rothamsted, ADAS, Cranfield)  <i>All sector leads draft the key information that is needed to present to UK Government / NISC to explain all changes / improvements in methods, data and resultant recalculations, and prepare updated documentation for the purposes of the NIR and IIR.</i></p> <p><b>Draft Scheduler sheets</b> (Rothamsted)  <b>QC of Scheduler sheets</b> (All sector leads: Rothamsted, ADAS, Cranfield)  <i>The output Scheduler sheets are generated for ease of use / data accessibility, primarily for UK Government inventory data users.</i></p> <p><b>Engagement with UNFCCC expert reviews</b> of the UK inventory (All, as required)</p>
October	<p>Documentation of methods; <b>preparation of reporting outputs</b>, e.g. CRF Reporter (Rothamsted)  <i>The Inventory Agency combines the agriculture sector with the rest of the UK inventory data; the agriculture inventory experts focus on preparing formal reporting outputs.</i></p>
November	<p><b>National Inventory Steering Committee</b> meeting (Rothamsted, ADAS)  <i>Sector leads present to the NISC Advisory panel on agriculture inventory improvements, latest data for the next UK submission to the UNFCCC on GHG emissions.</i></p>
December onwards	<p><b>Contributions to national and sub-national reports</b>, including the NIR, IIR, DA reports, mapping reports (All, led by Rothamsted).</p> <p><b>Stakeholder engagement / QA activities</b>, such as post-submission review, dialogue with Defra, DAs and the farming sector to identify potential inventory improvements.</p>



**A 3.3.7.12 Raw data inputs**

The UK inventory model calculations are driven by data held in a number of databases; one of these is a static database of physical data per 10 by 10 km grid cell that holds data on soil types and climatic data, whilst the annual updates are driven by annual survey data that are updated and extended each cycle inventory cycle. These are described below.

**Physical database: geography, elevation, soil and climate - description**

The **physical database** holds data on soils and climate, as well as defining the administrative boundaries and the geo-referencing for all agricultural holdings across the inventory reference 10 by 10 km grid cells. Agricultural holdings are also geo-referenced by country and Less Favoured Area status according to the location of the majority of their land area with respect to digitised vector boundaries. Agricultural holdings can only be located in one cell, country and Less Favoured Area type. The choice of grid size reflects uncertainty in agricultural holdings that are variously geo-referenced by parish, holding office or field centroids, but is principally justified by the confidentiality restrictions placed on the mapping of inventory input and output datasets, specifically derived from the June Agricultural Survey. Confidentiality restrictions prevent the mapping of summary statistics for fewer than 5 or 10 holdings, depending on the data source. Each grid cell that is located within England is assigned to one of nine Government Office Regions (GORs); the country boundaries define grid cell allocations to England, Scotland, Wales and Northern Ireland. All agricultural holdings are geo-referenced with respect to the Less Favoured Areas (LFA) designations (Disadvantaged and Severely Disadvantaged Areas). The LFA designation is used within source category methods to aid characterisation of farm system types. Common land may be grazed by cattle and sheep but is not reported by the June Agricultural Survey, which reports only land that is owned and managed by an individual; areas of registered common land within England, Wales and Northern Ireland, and the area of forage claims on common grazings in Scotland are geo-referenced across the inventory 10 by 10 km grid cell.

The average altitude (m) above sea level of each inventory grid cell has been calculated from the Ordnance Survey Panorama dataset, under the Open Data licence, at a source spatial resolution of 50 by 50 m and elevation resolution of 10 m; these data are also held in the physical database.

Soil properties, notably field capacity, plant available water and percent clay and organic carbon content are used as input to inventory calculations of grass growth and nitrogen leaching following application of fertilisers, managed manures and excreta returns. The UK inventory uses the RB209 (MAFF, 2000) soils classification, based on soil texture and depth to rock, with seven soil types (light sandy, shallow, medium, deep clay, deep fertile silty, organic, peaty). For each country, soil scientists from the James Hutton Institute (Scotland), National Soils Resources Institute University (England and Wales) and the Agri-Food and Biosciences Institute (Northern Ireland) applied the RB209 soil typology to national digital soils datasets. The resulting United Kingdom map of RB209 soil types was spatially intersected with the reference 10 by 10 km grid to provide a statistical summary of the percent of the agricultural land area located on each of the RB209 soil types. The same national digital soils datasets were also used to calculate the percent of the soil area within each grid cell (excluding peaty soils) that is alkaline, based on topsoil measurements of pH ( $\geq 7$ ), which is used in calculations of ammonia ( $\text{NH}_3$ ) emissions from manufactured fertilisers.

Long-term annual and monthly average rainfall and air temperatures were obtained from the Met Office. Met Office UKCP09 baseline average datasets are for the period 1981 to 2010 (Jenkins et al., 2008). The UKCP09 data are available at 5 by 5 km resolution and summarised to the reference 10 by 10 km grid cells used in the agriculture inventory model. Daily time-series of measured rainfall derived from the UK synoptic network for the MORECS model (Hough and Jones, 1997) were obtained from the Met Office across the 1981 to 2010 time series at 40 by 40 km resolution. The probabilities of more than 5 mm of rainfall falling in 24 hours within 1 to 6 days (or more) of a nitrogen application to land (used in calculations of ammonia ( $\text{NH}_3$ ) emissions from

manufactured fertilisers), occurring with equal probability on each day of the year, were calculated for each of the MORECS grid squares. The resulting probabilities were correlated with annual rainfall and downscaled to the reference 10 by 10 km grid cells.

### **Annual Inventory updates: survey data on agricultural activities**

The inventory model calculations are primarily driven by three core annual agriculture activity datasets, supplemented by other data inputs from annual or periodic statistical releases and targeted research. The three key annual datasets (*described in more detail below*) are:

- The June Agricultural Survey, or Census (JAS/C)
- The Cattle Tracing System (CTS)
- The British Survey of Fertiliser Practice (BSFP)

These three surveys together provide most of the required annual activity data to drive the inventory model estimates, i.e. of livestock numbers, crop production and fertiliser use. None of the three are comprehensive annual surveys of every UK farm holding; each are stratified surveys aiming to gather data from a large, representative sample of farm holdings from across the country. There are some minor differences in the precise scope and management of these surveys within the UK, as each is conducted per constituent country, i.e. within England, Scotland, Wales and Northern Ireland (E, S, W, NI) separately, but there is a good level of consistency in data gathering across all of the UK. Many of the same reporting systems (and survey questions etc) are applied across Great Britain (E, S, W) whilst the Northern Ireland Farm Business Survey (NIFBS) delivers the equivalent data for Northern Ireland.

### **The June Agricultural Survey / Census - description**

The June Agricultural Survey/Census (JAS/C) provides farm/holding level information on crop areas and livestock numbers for the UK. It is the only survey of its kind for the UK, with areas/numbers updated annually; a full census of all farms is conducted infrequently (typically every 10 years). The government statistical authorities for each of the four countries of the United Kingdom (i.e. England, Wales, Scotland and Northern Ireland) carry out separate surveys every year, with varying levels of sample sizes between the full census years. The statistics teams then use a process called “imputation”, where they extrapolate from the samples to the full set of holdings, using a range of auxiliary government databases in the process.

Overall, the data collected in the JAS/C are broadly similar for each of the four UK countries, with small differences according to types of crops grown and livestock kept in different regions. However, the level of detail of the livestock and crop categories changes between JAS/C years. For example, some crop types are discontinued as areas diminish over time, and instead are incorporated with a summary category such as “other crops and tillage”. The level of detail may also differ across the four countries to reflect local priorities, e.g. agriculture in Wales has relatively little cropland, and therefore only the main crops are reported individually, with other crop types only reported at a summary level. A key part of the Inventory Agency role is to harmonise across time series (1990 to present) as well as between countries, to provide the best possible input data for the agricultural emission model.

The JAS/C data are collected annually on 1st June through questionnaires sent to individual agricultural holdings above minimum size thresholds, with each holding being identified with a unique ID, referred to in Great Britain (E, S, W) as the ‘County Parish Holding number’ (CPH). The equivalent ID in Northern Ireland is the “Farming Community Network number” (FCN).

During the period from 1990 to present, the data collection methodology has generally moved from a full census towards more survey-based coverage across the UK, with full censuses only carried out at longer intervals, and varying survey sample sizes in intervening years. Over recent years, there has also been a trend to substitute/combine data from other government systems, such as databases for veterinary/animal health and agricultural subsidy systems, thereby

reducing the need to ask farmers for duplicate information. This has the additional advantage of reducing uncertainties due to non-returns of the annual census-survey questionnaires. In general, the agricultural statistics departments estimate data for holdings where no returns are received by 'imputation', i.e. using previous data and general trends as substitutes. The main differences in the census-survey methodology used by the four UK countries are described in more detail below, describing the detailed category from 1990 and how to deal with such changes consistently across the inventory timeline.

The JAS/C is used as input to the agricultural emission model for the following data:

- ✓ Holding locations: Each holding is assigned to a 10 by 10 km grid square used by the model;
- ✓ Arable and grassland area: The JAS/C records the land area of arable and grassland for each holding, this is used to estimate emissions associated with land use (e.g. emissions from fertiliser application);
- ✓ Livestock numbers (for non-cattle livestock): The number of livestock on each holding is estimated by the JAS/C;
- ✗ Cattle population data are supplied separately from Cattle Tracing System (CTS).

### **The Cattle Tracing System (CTS) - description**

The British Cattle Movement Service<sup>20</sup> (BCMS) administer the Cattle Tracing System (CTS) database, which records the details of all bovine animals in Great Britain; all cattle have a unique ID, held on ear tags and within a cattle passport (held by the animal owner). These cattle numbers / IDs remain with each animal throughout its life and are recorded by the slaughterhouse at death enabling beef to be traceable to its origins. All GB farmers must notify births, movements and deaths of cattle on their holdings and log information within the CTS database. The Inventory Agency receives a complete copy of the CTS dataset annually from the Animal and Plant Health Agency (APHA) which uses CTS for cattle disease tracing and surveillance; the Inventory Agency analyses the CTS data to develop activity data that reflect the GB herd per holding according to cattle breed, type, age, including monthly datasets.

As regards data scope and limitations, the CTS covers all cattle births, movements and deaths in Great Britain from 28 September 1998; all farmers must use the system for all bovine animals for the beef to be traceable and hence the CTS data are highly complete (it is essentially a census) except for instances where animals may be in transit or at vets or market on specific days. The CTS does not cover Northern Ireland which has a separate tracing system in place; the Inventory Agency obtains equivalent cattle data from Northern Ireland government. The introduction and use of CTS datasets was phased in across GB, with some data discontinuity evident when compared against JAS/C data and when new breeds / categories are identified and reported over time. Overlap periods were used per DA to QA the change-over from using JAS/C to CTS data, including 2004-6 for Wales, 2005-6 for England and 2011 for Scotland.

There is ongoing work in the UK to develop a more holistic Livestock Information Programme<sup>21</sup> (LIP) via a partnership between industry and government to develop a digital traceability system for a wider scope of livestock, to include sheep, cattle, pigs, goats and deer. The primary reason for the system development is to facilitate rapid and effective disease prevention and management but the Inventory Agency is in dialogue with the team of developers to ensure that inventory data requirements may be designed into the LIP. LIP (or equivalent) systems are planned for each constituent country of the UK and over time this is expected to replace the CTS

---

<sup>20</sup> <https://www.gov.uk/government/organisations/british-cattle-movement-service>

<sup>21</sup> <https://ahdb.org.uk/livestock-information-programme>

as an inventory data source, and also augment the data provision for inventory methods for other UK livestock types.

### **The British Survey of Fertiliser Practice (BSFP) - *description***

The British Survey of Fertiliser Practice<sup>22</sup> (BSFP) is a nationally representative interview survey based on a random stratified sample of farms from mainland Britain and collects evidence on all aspects of fertiliser management. The survey takes place in spring and is published in summer each year, reporting on the previous agricultural year. The survey enables the calculation of annual application rates of fertilisers to agricultural crops and grassland by crop / grass type and by fertiliser type, using the information from the representative, stratified farm-level responses, scaled up to estimate the total fertiliser applied. The survey is funded by Defra and the Scottish Government, and the annual database of responses is provided to the Inventory Agency around mid-July each year to enable direct query of the raw data for the purposes of the national inventory compilation. The survey outputs contain information on trends in the use and application rates of nitrogen, phosphate, potash, sulphur, organic manures and lime onto crop and grassland. The survey seeks to identify the cropping patterns that influence fertiliser rates and dressing covers, including for key crops (e.g. winter wheat, winter barley, oil seed rape, other tillage crops).

The BSFP has been run since the 1940s across England and Wales, with amalgamated data for GB presented since 1992, as well as individual data for Scotland, England and Wales. The method is described in detail within annual reports but can be summarised thus:

- A sample of holdings are surveyed to reduce the reporting burden on the industry and to manage resources efficiently. In 2021 the target sample size was 1,500 farms and the actual sample size was 1,310; this is regarded as a statistically representative sample size nationally.
- The survey sample is selected from the population of agricultural holdings that report to the JAS/C, with survey samples selected from either Scotland or from England & Wales. Holdings with <20ha allotted to crops and grass in total are excluded from the BSFP sample.
- In England & Wales, farms are classified across three types: cropping, livestock, horticulture, and then four size groups. Scotland farms are classified similarly but across two types: mainly cropping and mainly livestock. Robust farm type “Other” are excluded.
- The survey design is such that the number of farms sampled per farm type and size combination (strata) is in proportion to the latest JAS/C data on total area of crops and grass, except for E&W horticultural farms which are sampled at a higher rate to ensure that a robust estimate can be made across this more heterogeneous farm type.
- To assure survey response rates and reduce year to year variability, a core of respondents completes the survey annually; for example in 2021, 74% of the panel had responded the previous year.
- This sample design is constructed primarily to collect data on manufactured fertiliser usage, whilst it may not fully represent farms using organic manures; therefore the survey responses are considered accordingly by the Inventory Agency, taking note of the sample sizes per fertiliser type.

---

<sup>22</sup> <https://www.gov.uk/government/collections/fertiliser-usage>

## Other Input Datasets used for the UK Agriculture Inventory

In addition to the three core, cross-cutting annual datasets outlined above, the UK Inventory Agency requests a host of other data for use within the inventory source category methods annually. The most critical of these additional datasets are summarised here:

**Table A 3.3.21 Agriculture Inventory: Main Annual Data Inputs per Data Provider**

Data Provider	Data / information
Defra	Monthly UK Statistics on Cattle, Sheep and Pig Slaughter and Meat Production UK Home Fed Meat Production, Trade and Supplies Sheep and Lamb Dressed Carcase Weights - England Slaughterhouses Only Agriculture in the United Kingdom, Chapter 7 - Crop Area and Production Cereal and Oilseed Area, Yield and Production UK Poultry Slaughter Weights and Poultry Meat Production - Monthly Data UK Chick and Poultry Placings - Monthly Data England Farm Type and England Holding Locations - Holding Level Datasets Horticulture Statistics Dataset - Area and Production England and UK, ideally also the GB/NI split of milk yield from dairy cattle
DAERA	Northern Ireland Farm Business Survey DAERA-NI Fertiliser Delivery Statistics Northern Ireland June Agricultural Survey - Holding Level Dataset Northern Ireland June Agricultural Survey - National summary data NI dairy and beef cow breeds percentages Northern Ireland Lamb and Ewe Carcase Weights
Scottish Government	Scotland June Agricultural Survey - Holding Level Dataset Scotland June Agricultural Survey - National summary data Scotland milk yield data; Economic Report on Scottish Agriculture: Scotland Slaughtered Sheep Number and Weight
Welsh Government	Wales June Agricultural Survey - Holding Level Dataset Wales June Agricultural Survey - National summary data
AHDB	Great Britain Animal Feed Production Performance indicators: Pork indoor breeding herd, Pork outdoor breeding herd, Pork rearing 7-35kg herd, Pork finishing 35-110kg herd.
Hybu Cig Cymru	Wales Total Sheep Carcase Weights
ESCAA	Certified Seed Production in the United Kingdom
IFA Stat	IFA Stat Fertiliser Supply and Consumption
National Bovine Centre	Cattle breed performance statistics
SRUC	Estimated liveweight of mature cows (from slaughter weight data)
UKCEH	Anaerobic Digestion data (agriculture sector only); Mineralisation data
Ricardo	Sewage sludge data; Poultry litter incineration data

The above datasets are used by sector experts in the annual updates to inventory methods, as described within the main chapter of the National Inventory Report.

In addition to the above annual routine data requests, the UK agricultural methods also rely on periodic data inputs / updates, which may be the result of interstitial sector surveys or one-off research by academics or other organisations. These datasets include:

- Holding location information / numbers, for example: <https://ahdb.org.uk/pork/uk-pig-numbers-and-holdings>
- Killing-out percentages: <https://ahdb.org.uk/knowledge-library/killing-out-percentage>
- UK farming structural analysis, for example: [https://assets.publishing.service.gov.uk/government/uploads/system/uploads/attachment\\_data/file/1106562/AUK\\_Evidence\\_Pack\\_2021\\_Sept22.pdf](https://assets.publishing.service.gov.uk/government/uploads/system/uploads/attachment_data/file/1106562/AUK_Evidence_Pack_2021_Sept22.pdf)
- UK fertiliser sales, import, export data, including industry publications such as: <https://www.agindustries.org.uk/resource/fertiliser-consumption-in-the-uk.html>
- Detailed surveys or research projects on e.g. housing, management practices
- Information / research regarding the uptake and impact of mitigation actions
- The findings of literature searches and / or stakeholder consultations that inform of new research or data on EFs, assumptions.

### **A 3.3.7.13 Mitigation Actions per Source Category**

Within the source category methods across all sectors there is scope for consideration of the impacts of mitigation measures, which may impact upon the source emissions of ammonia (NH<sub>3</sub>) and/or GHGs. The inventory model code has been developed such that method algorithms can call upon parameters (*where available*) that indicate the level of uptake and the impacts of the mitigation measure per pollutant at a detailed level of resolution (e.g. per DA, per crop/livestock type, per stage – e.g. housing, storage, yarding, spreading). This ensures that the inventory model can reflect the impacts of mitigation uptake, where it occurs, subject to data availability

Although there are only a relatively small number of distinct measures (*summarised in the table below*), each is potentially applicable to a number of sectors and sources with variations in cost and effect, resulting in around 200 measure variants across the inventory. The list of variants covers all those currently reflected in the Agricultural Ammonia and Greenhouse Gas Inventory (AAGHGI), and some which are applicable only to future projection scenarios but is not comprehensive.

Measure uptake values are year specific, and often region-specific (e.g. per DA, for GB only, for NI only) as they are based on a range of data sources, typically the annual surveys noted above (i.e. the BSFP, the JAS/C) or from more targeted surveys and studies, such as the Farm Business Surveys that are conducted around the UK, capturing evidence on current farm management practices. Each mitigation measure is associated with a target Sector, Stage, Country, Farm Type, Item, Source and Location and then with a reduction factor applicable to the unmitigated pollutant (e.g. NH<sub>3</sub>, N<sub>2</sub>O, CH<sub>4</sub>) emission factor. For the purposes of policy scenario analysis, each measure is also considered on a cost basis (per stock place, per occupied stock place, per mass of manure, per mass of nitrogen fertiliser), a cost value comprising capital and operating components and a list of mutually exclusive mitigation measures for the target Stage, Location and Source.

Pollutant emission reduction factors are primarily based on empirical evidence, largely from experimental work conducted in the United Kingdom but also taking account of relevant international studies and with reference to international literature such as the UNECE Task Force for Reactive Nitrogen Ammonia Abatement Guidance Document (Bittman et al., 2014).

*Mitigation actions represented in the inventory model are summarised in the table below. Full details of all these parameters, references and dependencies can be provided upon request.*

**Table A 3.3.22 Mitigation Measures reflected within Inventory Source Methods**

Measure	Sector(s)	Stage / Source	Uptake / comment
Reduction in dietary crude protein for livestock	Dairy, Beef, Pig, Poultry	Housing / ↓N excretion	Where dietary CP is in excess to requirement, reductions in intake will be reflected in reductions in urinary N excretion.  <i>This is a scenario measure, not implemented in the historical inventory time series.</i>
Extending the grazing period	Dairy, Beef	Housing / Slurry, FYM	Where soil conditions allow, longer grazing season means cattle urine returns will infiltrate the soil and this has a lower NH <sub>3</sub> EF compared to urine deposited on concrete and managed as manure.  <i>This is a scenario measure, not implemented in the historic inventory time series.</i>
Washing outdoor dairy collecting yards	Dairy	Yarding / Slurry	Applies to outdoor dairy cattle concrete collecting yards where washing rather than just scraping reduces excreta from surfaces, reducing emissions.  <i>~73% GB; ~100% NI uptake in recent years</i>
Increased scraping frequency: dairy cow cubicles	Dairy	Housing / Slurry	More frequent removal of excreta from dairy cow cubicle floors to the slurry store, (e.g. twice a day) will reduce the source from which emissions are occurring.  <i>Implementation assumed as zero to date.</i>
Grooved floors: dairy cow cubicles	Dairy	Housing / Slurry	Grooved concrete floor plus “toothed” scrapers means quicker removal of urine from the floor surface to slurry storage, reducing the emissions potential from the floor.  <i>Implementation assumed as zero to date.</i>
Slat mats with scrapers for slatted floor cattle housing	Dairy, Beef	Housing / Slurry	Rubber slat mats fitted to concrete slatted floor. The hard-wearing curved smooth surface promotes urine and dung movement to the below-slat storage pit. Automatic scraper units remove manure from surfaces.  <i>Implementation assumed as zero to date.</i>
In-house slurry acidification	Dairy, Pig	Housing / Slurry	Acidification of the below-slat slurry through the automated addition of acid (normally sulphuric) to achieve a slurry pH of below 6.  <i>Implementation assumed as zero to date.</i>
Partially slatted floor with reduced pit area	Pig	Housing / Slurry	Modified floor and pit design result in lower emissions from the floor and below-slat slurry storage compared with conventional fully slatted systems for weaner and finishing pig slatted floor housing.  <i>2007 onwards ✓; now assumed BAT on EPR-permitted farms. Assumed 33% uptake across UK for weaner and finishing pig housing in recent years</i>
Frequent slurry removal from under-slat	Pig	Housing / Slurry	Replace longer-term below-slat slurry storage with more frequent (twice per week), complete removal of slurry to an outside store using a vacuum removal system.

Measure	Sector(s)	Stage / Source	Uptake / comment
storage in pig housing			2007 onwards ✓; now assumed BAT on EPR-permitted farms. Assumed 22% uptake across UK in sow & gilt housing, 0% in weaner & finisher housing.
Acid air scrubbers for mechanically ventilated housing	Pig, Poultry	Housing / Slurry	Acidified moisture air scrubbers fitted to the outlets of mechanically ventilated pig or poultry housing to remove almost all ammonia from exhaust air.  <i>Implementation assumed as zero to date.</i>
On-belt drying of manure in laying hen housing	Poultry	Housing / Layer manure	Drying systems installed in laying hen houses reduce the moisture content of the layer manure collected on below-cage belts -> delays hydrolysis of the excreted uric acid in the manure, lowering NH <sub>3</sub> emissions.  <i>Implementation assumed as zero to date for GB; NI data indicates ~7% uptake in recent years, started ~2000.</i>
Litter drying for poultry housing	Poultry	Housing / Poultry litter, poultry manure	Drying litter using above-floor fans, heat exchanger units, below-floor systems reduce the poultry litter moisture content -> delays hydrolysis of the excreted uric acid in the manure, lowering NH <sub>3</sub> emissions.  <i>Assumed as BAT on EPR-permitted farms for housing for growing pullets, breeding birds, broilers, turkeys, ducks, geese and all other poultry except for laying hens. Assumed 72% uptake: growing pullets, breeding birds, broilers; 35% uptake: turkeys, ducks and geese, all UK.</i>
Natural crusting of cattle slurry storage	Dairy, Beef	Storage / Slurry	Allow natural crust to develop on stored slurry surfaces, (fibre, bedding material in the slurry); retain the crust to create a physical barrier between the ammoniacal N in the slurry and the air above the crust, reducing ammonia emissions for above ground slurry tanks, lagoons.  <i>80% of dairy and beef cattle slurry storage is assumed to develop a natural crust; all years, all UK.</i>
Rigid cover on slurry / digestate tank	Dairy, Beef, Pig, Poultry	Storage / Slurry (above ground slurry tank)	Fixed cover, with vents, fitted to slurry tanks to reduce ammonia emissions. Reduces airflow across the slurry surface; higher ammonia concentration builds up in the headspace inhibits emission from the slurry surface.  <i>Implementation assumed as 0% to date for cattle slurry tanks in GB, 3% uptake in Northern Ireland since 2010; 2007 onwards ✓ now assumed BAT on EPR-permitted pig farms. Assumed 24% uptake across UK in recent years.</i>
Floating cover on a slurry/digestate tank or lagoon	Dairy, Beef, Pig, Poultry	Storage / Slurry (above ground slurry tank, slurry lagoon)	Floating covers of permeable or impermeable materials that reduce ammonia emissions by restricting contact between the slurry surface and the air.  <i>Implementation assumed as zero to date for cattle slurry tanks; 2005 onwards ✓ now assumed BAT on</i>



Measure	Sector(s)	Stage / Source	Uptake / comment
			<i>EPR-permitted pig farm slurry lagoons. Assumed 24% uptake across UK in recent years.</i>
Sheeting cover for solid manure	Dairy, Beef, Pig, Poultry, Sheep, Minor livestock	Storage / solid manure (heaps)	A sheeting cover provides a physical barrier preventing transfer of ammonia from the manure heap to the air.  <i>Implementation assumed as zero to date across all sectors and all of UK.</i>
Slurry/digestate application by band spreading (trailing hose)	Crop, Grass, Dairy, Beef, Pig	Spreading / Slurry, digestate to grassland, arable land	Slurry applied to land in narrow bands via hoses trailing from the slurry applicator boom to just above the soil surface. The emitting slurry surface area is greatly reduced compared with surface broadcast application. Ideal for arable crops; placement of slurry below the crop canopy reduces air flow reducing emissions more.  <i>Assumed uptake by 2021: 0% cattle or pig slurry to grassland; 15% cattle slurry to cropland in GB, 25% in Northern Ireland; 28% pig slurry to cropland; 77% cattle or pig digestate to grassland or cropland.</i>
Slurry/digestate application by trailing shoe	Grass, Dairy, Beef, Pig	Spreading / Slurry, digestate to grassland	Slurry applied to land in narrow bands via hoses with adapted ends ('shoes') trailing from the slurry applicator boom directly to the soil surface, below the grass canopy. The emitting slurry surface area is greatly reduced compared with surface broadcast application and further protected by the grass canopy which reduces air flow at the emitting surface.  <i>Assumed uptake by 2021: 15% cattle in GB, 10% in Northern Ireland, 28% pig slurry to grassland; 0% cattle or pig digestate to grassland.</i>
Slurry/digestate application by shallow injection	Crop, Grass, Dairy, Beef, Pig	Spreading / Slurry, digestate to grassland, arable land	Slurry or digestate applied to soil in shallow surface slots, greatly reducing the emitting surface area of the slurry in comparison with surface broadcast application. Ammonium-N in slurry or digestate placed directly into the soil will be fixed on to clay particles, further reducing the potential for ammonia emission.  <i>Assumed uptake by 2021: 7% cattle slurry to grassland or cropland in GB, 0% uptake in Northern Ireland; 23% cattle digestate to grassland or cropland; 23% pig slurry or digestate to grassland or cropland. (BSFP)</i>
Slurry/digestate application by deep injection	Crop, Grass, Dairy, Beef, Pig	Spreading / Slurry, digestate to grassland, arable land	Slurry or digestate applied to soil behind tines which ~eliminates the emitting surface area of the slurry in comparison with surface broadcast application. Ammonium-N in slurry or digestate placed directly into the soil will be fixed on to clay particles, further reducing the potential for ammonia emission.  <i>Assumed uptake by 2021: 2% cattle slurry to grassland or cropland in GB, 1% in Northern Ireland; 0% cattle or pig digestate to cropland. (BSFP)</i>
Rapid soil incorporation of slurry,	Crop, Dairy, Beef,	Spreading / Slurry, Digestate,	Surface applied manure is incorporated into the soil by ploughing or by disc or tine cultivation soon after application. The shorter the delay between application

Measure	Sector(s)	Stage / Source	Uptake / comment
digestate or solid manure following application	Sheep, Pig, Poultry, Minor livestock	Solid manure to arable land	and incorporation, the greater the emission reduction. The inventory models two approaches: 4h, 24h delay. <i>Assumed uptake by 2021: 2% cattle slurry or FYM disc 4hr; 3% cattle slurry disc 24hr; 5% cattle FYM disc 24hr; 3% pig slurry or FYM disc 4 hr; 2% pig slurry disc 24hr; 10% pig FYM disc 24hr.</i>
In-field slurry acidification	Dairy, Beef, Pig	Spreading / Slurry to grassland, arable land	Slurry is acidified during the spreading operation through the use of a specially adapted tanker which adds acid to the slurry to reduce the slurry pH to < 6. <i>Implementation assumed as zero to date.</i>
Use of a urease inhibitor with urea fertiliser	Crop. Grass	Fertilising / Fertiliser (Urea, UAN)	Apply a product with urease inhibitor incorporated with the urea to delay the hydrolysis of urea to ammonium carbonate, giving more time for the fertiliser to enter the soil matrix, reducing potential for ammonia emissions. <i>Assumed uptake by 2021: 16% urea to cropland; 10% UAN to cropland; 17% urea to grassland; 6% UAN to grassland.</i>
Direct soil incorporation of nitrogen fertiliser	Crop. Grass	Fertilising / Fertiliser (all types)	Incorporation of fertiliser into soil by direct closed-slot injection or by cultivation. Mixing with the soil matrix greatly reduces potential ammonia emissions. Applicable to tilled land prior to crop establishment. <i>Assumed uptake by 2021: 0% all to grassland; 5% urea to cropland; 3% AN, UAN to cropland; 9% CAN to cropland; 36% AS to cropland; 34% Other to cropland.</i>
Genetic improvement in livestock	Dairy, Beef, Pig, Poultry	Housing, Grazing, Yarding / N excretion	Selective breeding for feed conversion efficiency improvements to reduce N excretion per animal. <i>This is a scenario measure, not implemented in the historical inventory time series.</i>
Cover crops	Crop	Fertilising, Cultivating / Fertiliser, Residue	Planting of a cover crop enhances over-winter nitrogen plant uptake and reduces nitrate leaching, and hence indirect nitrous oxide from leached nitrate. <i>Assumed uptake by 2021 is per DA at: 4% for England and Scotland, 3% for Northern Ireland and 16% for Wales.</i>

### A 3.3.7.14 Pre-processing

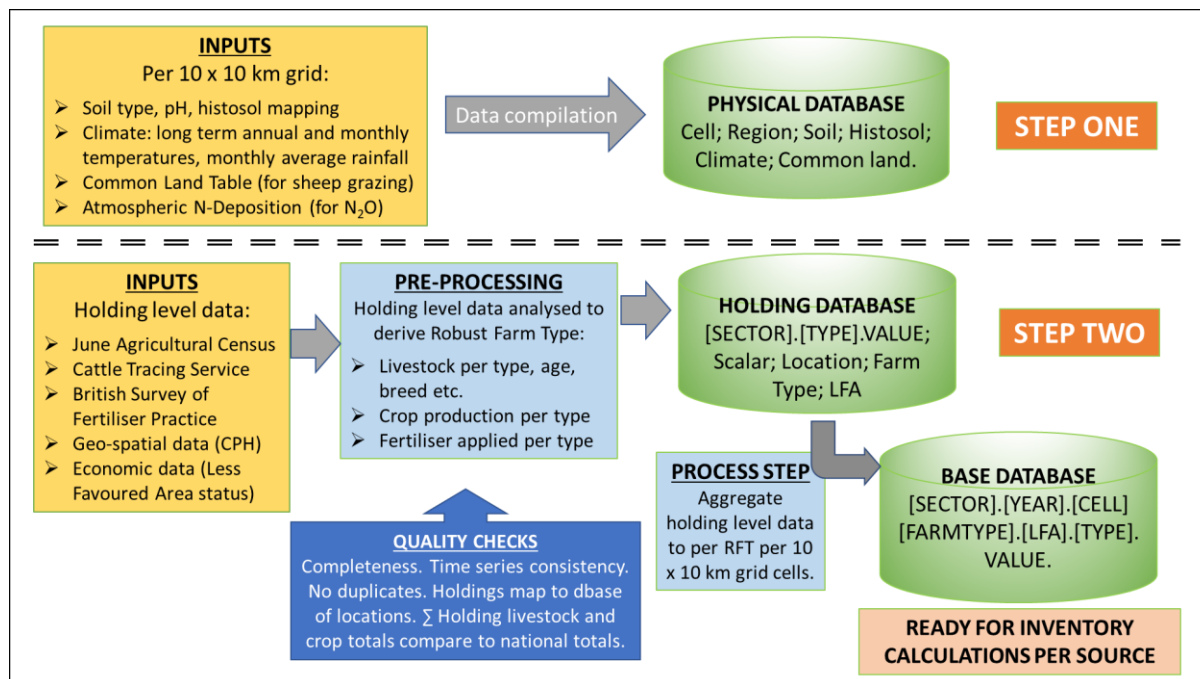
Each of the three key annual surveys provide input data for multiple source categories within the UK inventory; all require pre-processing into a common format of activity data tables, including steps to:

- ✓ allocate survey data into agriculture inventory source-specific activity data (e.g. raw data on cattle numbers per breed, age, allocated to defined inventory livestock sub-categories; raw data on crop production allocated to defined inventory crop types);
- ✓ conduct quality checks between (i) detailed spatially-resolved survey data, and (ii) published annual statistical summary data at country (i.e. E, S, W, NI) level;

- ✓ identify gaps and outliers, run range checks, time-series consistency, completeness and internal consistency checks;

The data flow in the first steps of inventory compilation are summarised in the schematic below.

**Figure A 3.3 Inventory Model Data Flows: Pre-processing Steps**



### **PROCESS STEP: Assignment to 10 x 10 km grid squares**

Across all of the data pre-processing, the various survey data are used to generate spatially resolved activity data estimates at the holding level, which are then aggregated at 10 x 10km grid square level, ready for use in the inventory calculations per source category.

For holdings in England and Wales (10 x 10 km) emission model grid squares are assigned based on Easting and Northing of the holdings, as supplied in the JAS/C holding level data. In rare instances, where the Easting and Northing of a holding is not associated to a valid grid square (i.e. associated with the correct country/region), the parish associated with each holding is used to assign a grid square, based on the centroid of the parish.

For Scottish holdings, grid squares are assigned using postcode information associated with each holding. To ensure consistency throughout the time series, additional pre-processing is needed to ensure accuracy, for example to cross-check postcode information against parish records in the JAS/C.

For Northern Ireland, grid squares are assigned in the same way as for England and Wales, with holding coordinates converted from Irish National Grid (TM75) projected to British National Grid coordinates.

### **PROCESS STEP: Robust Farm Type (RFT) Calculation**

The UK inventory model conducts calculations at the level data aggregated per Robust Farm Type (RFT) within each 10 x 10 km grid square, for each source category. The RFT allocation process is critical to the methodology as the UK model applies assumptions regarding the farm management practices and investment in technologies/fertiliser use etc according to the RFT type; for example, a mixed farm with a small number of cattle and some cropland for arable will

likely manage manure waste differently to a large farm that is predominantly beef or dairy and manage fertiliser use differently to a large arable farm. The RFT allocation enables the inventory to model farm management practices aligned to the relative economic importance of different products per holding.

The farm type of each holding is calculated using the method outlined in the EC typology handbook. Farm type is based on the type of farming and economic size, determined on the basis of Standard Output (SO) coefficients and structural information (area of crops and number of heads of livestock) of the various types of agricultural production. Ten robust farm types (RFT) are applied at Devolved Administration level (England, Wales, Scotland and Northern Ireland): (1) cereals; (2) general cropping; (3) horticulture; (4) specialist pig; (5) specialist poultry; (6) dairy; (7) Grazing livestock (LFA); (8) Grazing livestock (Lowland); (9) mixed; (10) other.

Although the Robust Farm Types of (most) holdings are calculated as part of the JAS/C (by the relevant statistical authorities), methodologies and coefficients used to estimate Standard Outputs (SO) have changed over time and hence the Inventory Agency has produced a consistent time series, using a common set of coefficients and a consistent methodology. To preserve the contribution each census item makes to the Standard Output of a holding, unscaled versions of livestock (dairy, beef, sheep, pig, poultry and horses, goats and deer), grassland and arable sector tables from the agricultural census are used, together with cattle data from CTS.

Standard Output coefficients (for the year 2010) are applied to each agricultural census item (excluding deer) to assign a farm type. For specific years, some horticultural items in the holding level data must be disaggregated further into flowers and nursery stock, in order to apply the output coefficients consistently across all years in the time series.

### **The June Agricultural Survey / Census (JAS/C) – pre-processing**

As part of the annual inventory process, JAS/C data are acquired at the holding level from the country statistics authorities in the UK, i.e. Defra (England), the Scottish Government (Scotland), Welsh Government (Wales) and DAERA (Northern Ireland). Category totals are then cross-checked with national summary statistics. As a next step, the holding level data for the different countries are then aggregated to the common set of emission source categories used by the agricultural emission inventory model, to ensure compatibility between the different countries' systems and consistency over time. All data are then cross-checked against the national totals.

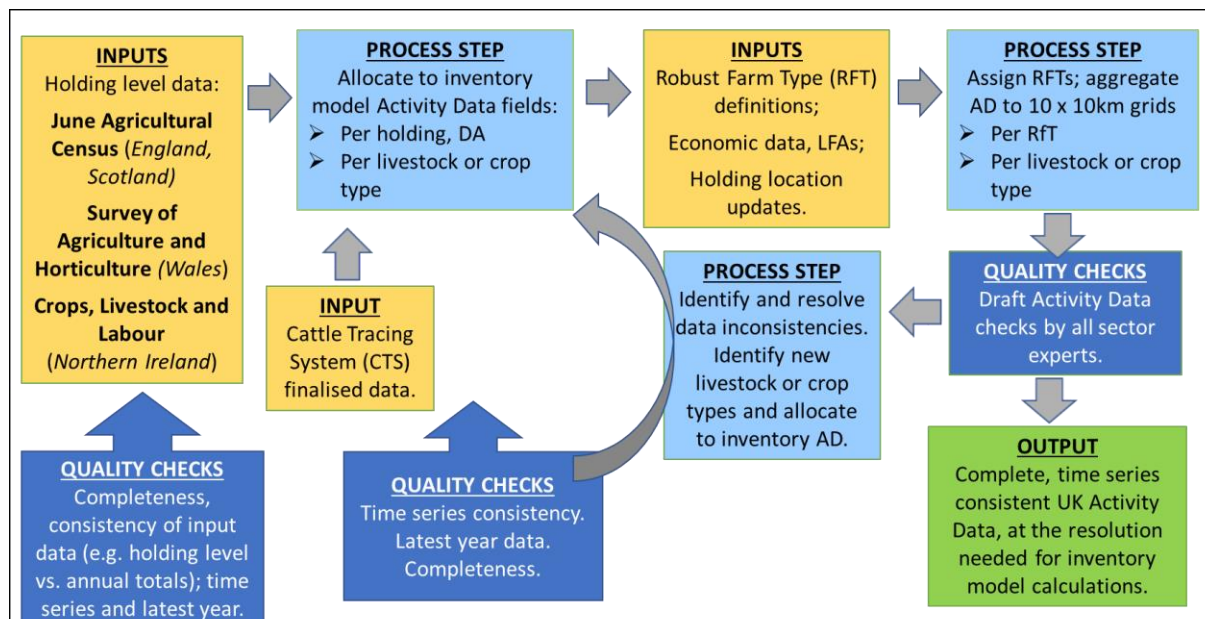
### ***QC STEP: Adjustments for missing data***

The original JAS/C holding level data received from the relevant government agencies contained a number of data gaps over the years. The majority of these data gaps are associated with the minor livestock sector (i.e. horses, farmed deer, goats), with some livestock categories not being recorded at the start of the time series (1990 – 1993). Some poultry categories were also missing from the time series, for example with no category for Turkeys in Scotland 1992 – 2015 and no poultry categories at all being present in the Welsh dataset for 1996. In all instances, these gaps were addressed by using IPCC good practice gap-filling techniques, such as interpolation or extrapolation of data from adjacent years, with the processes documented in detail.

Spatial information used to assign each holding to a 10 by 10 km grid square (as used by the agricultural inventory model) were missing for some holdings; these have been imputed based on other years, where available. Where this was not possible, alternative locational information such as parish centroids was used with these assumptions documented by the inventory team.

*The pre-processing of the JAS/C is summarised in the schematic below.*

**Figure A 3.4 Inventory Model Data Flows: Pre-processing of the JAS/C**



**QC STEP: Producing consistent cattle categories between CTS and JAS/C**

To achieve a consistent dataset of cattle population data across the time series (i.e. pre and post CTS, which began in 2005), some JAS/C categories needed to be split into sub-categories and re-aggregated for the emission model database. In particular, there is ambiguity for young cattle which are not explicitly associated to the beef or dairy sector in the JAS/C holding level data. The methods for deriving the required cattle categories are detailed below:

In the pre-CTS era (1990 – 2005, and all years to present for NI), census items frequently do not distinguish beef or dairy sector allocation, especially for young animals. In such circumstances, these ambiguous cattle categories were separated based on other cattle categories present on each holding, as detailed below:

- All ambiguous cattle are assigned to the dairy herd on holdings that contain only female breeding cattle from the dairy sector and NONE from the beef sector.
- All ambiguous cattle are assigned to the beef herd on holdings that do not contain any breeding females OR those containing only female breeding cattle from the beef sector but NONE from the dairy sector.
- Ambiguous cattle are split between the beef and dairy herd on holdings that contain both beef AND dairy breeding females and are split using the ratio of beef/dairy breeding females.

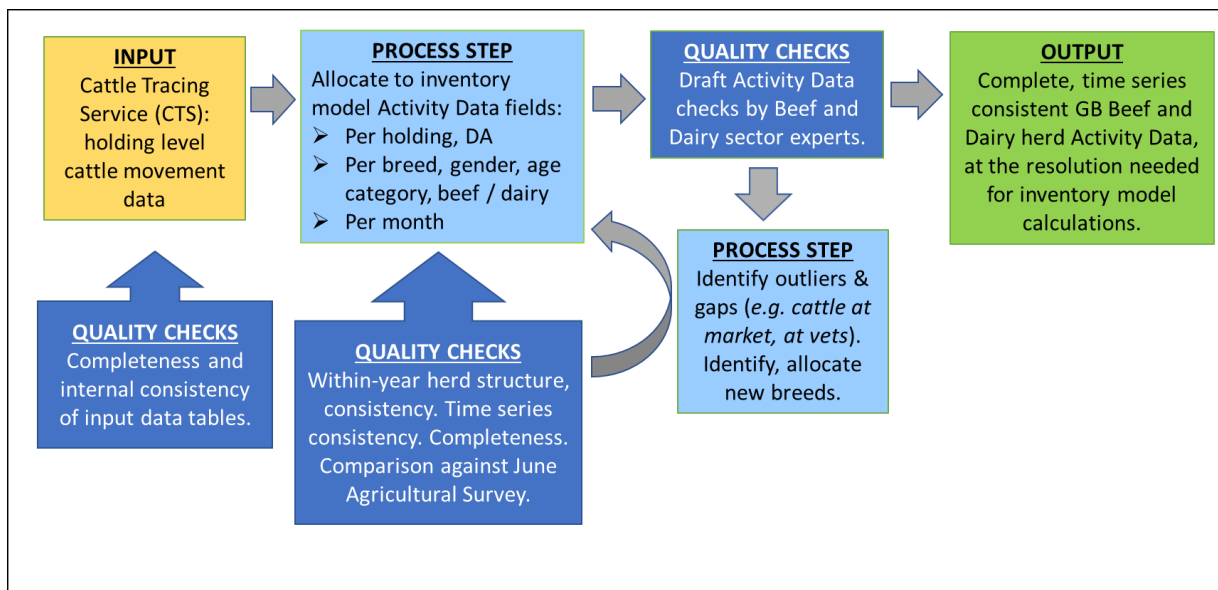
The methodology above was applied for all female calves (<1 year old), and for the category “female replacements >2 years”, which was present in the English dataset for the years 1990 – 1992.

**The Cattle Tracing System (CTS) – pre-processing**

The pre-processing of the CTS data is a computationally intensive process as the raw database from APHA is typically ~60GB in size for one year’s worth of data; the data are provided to the Inventory Agency on encrypted hard disks and the data processing is conducted by Cranfield University on a dedicated Solid State Drive (SSD) to improve computational performance and maintain data integrity.

*The pre-processing of the CTS is summarised in the schematic below.*

**Figure A 3.5 Inventory Model Data Flows: Pre-processing of the CTS**



The pre-processing of the raw data files to generate useable AD tables with the correct UK inventory data labelling and ready for source-category calculations comprises the following steps:

- **Raw data sense checks:** table record counts; record field counts to detect whether all rows are complete, and to check that none contain a naturally occurring delimiter; identification of new data fields and subsequent investigation and adaptation of code to handle them correctly. For example, new breeds must be identified and categorised for beef/dairy characteristics;
- **SQLite database build:** use of SQLite Administrator and DOS-prompt command line software to create the database, create the structure of the data tables, import the raw data into the appropriate data tables, index the data tables to enable faster querying, storage optimisation;
- **Querying the SQLite database:** SQLite3 scripted queries are used to extract monthly datasets of cattle and store them in another SQLite database; this process identifies all cattle that are alive, identifies their location from latest on-movement records. Data cleaning identifies exported or otherwise lost cattle; outputs are monthly cattle data per location, logged against locational information: Location ID, postcode, premises type and stay length;
- **Data cleaning and disaggregating:** The next step is to take the text file lists of animals alive per month and map them onto counts of cattle categorised by gender, breed type, cattle role, and age group, split into separate beef and dairy output tables. Within this there are some special considerations: *(further details are available within supplementary method documents)*
  - remove cattle that are located where the County Parish Holding (CPH) is of the form 99-xxx-xxxx as these are export or other anomalies like lost or stolen;
  - re-assign cattle that are dual breeds or unknown to either dairy or beef;
  - encode the cattle into cattle roles, breed type, and age group;
  - relocate cattle that are located off-farm, such as at a showground, onto the set of CPHs locations that exist within the June Census/Survey dataset; and
  - rescale the extracted cattle numbers at DA level to achieve agreement with the published June Agricultural Census/Survey dataset.

The output files are formatted respectively, using column headings ready for downstream data transfer via ACCESS database and tables, for subsequent checking by sector experts and then

use: (i) in the derivation of Robust Farm Type allocations (combined with JAS/C data), and (ii) within source category method calculations:

- "INVENTORY|YEAR|HOLDING|CATTLETYPE|CATTLEBREED|MONTH|NUMBER"
- "INVENTORY|YEAR|HOLDING|CATTLETYPE|CATTLEBREED|MONTH|AGECODE|NUMBER"

### **The British Survey of Fertiliser Practice (BSFP) – pre-processing**

The BSFP database is provided to the Inventory Agency, with the information on fertiliser type, rates, applications and location / field all then processed into datasets that are ready for use within the crop and grassland sector methods. The BSFP is a stratified survey that is designed based on the *previous year's* JAS/C; the Inventory Agency is able to take the JAS/C data from the latest inventory year (i.e. data on grass and crop production from the same year as the BSFP dataset) and re-stratify the results of the BSFP, to improve accuracy. The pre-processing involves several steps and is primarily conducted using R code and database tables, with outputs then held in inventory-ready Activity Data tables.

The Inventory calculations are based on a disaggregation of manufactured fertiliser nitrogen between 6 Fertiliser Types, having differing chemistry affecting their direct nitrous oxide and ammonia (NH<sub>3</sub>) emission factors. On a per kilogram of nitrogen basis, direct nitrous oxide emissions are generally higher from the nitrate-based Fertiliser Types (Ammonium Nitrate (AN) and Calcium Ammonium Nitrate (CAN)) (Cowan, 2020), whilst direct ammonia (NH<sub>3</sub>) emissions are higher from the urea-based Fertiliser Types (Urea (U) and Urea Ammonium Nitrate (UAN)) (Misselbrook et al., 2004). Ammonia emissions from the Ammonium Sulphate (AS) and Di-ammonium Phosphate (DAP) are critically sensitive to soil pH (Powlson and Dawson, 2020).

Data fields within the BSFP are linked to inventory data fields using Access queries, for example to use BSFP *crop* table information to allocate to inventory crop names, across grassland and cropland as well as identifying land that is set aside. e.g. BSFP entries for oats, spring oats and winter oats are assigned inventory crop codes 1, 2 and 3, but are all within inventory crop group #1 to enable data handling and aggregation where necessary to reflect the size of the survey dataset; similarly wheat, wheat – milling and wheat non-milling are inventory crop codes 10, 11 and 12, within the wider inventory crop type #10.

Estimates of manufactured fertiliser nitrogen is split across 6 fertiliser types; the BSFP *fertiliser type* table is amended to add inventory fertiliser labelling, for subsequent Access queries to extract all data separately for the 6 types used in the inventory: AN, CAN, U, UAN, OSN, NCB (compounds and blends). This enables individual BSFP records to be assigned to an inventory fertiliser category for subsequent calculations of fertiliser N content; further queries assign enumerators for urease inhibitors, nitrification inhibitors and fertiliser placed as well as validating the raw BSFP data by applying acceptance ranges for key parameters (e.g. to remove locations with spuriously high nitrogen application rates).

Analysis in Access to link details of BSFP database tables *crop* (e.g. *crop\_id*, *crop*, *crop\_group\_1*, *tillage\_or\_grass*) to *field* (*field\_id*, *crop\_id*, *farm\_id*, *field\_size\_sampled*) enables calculation of interim data such as *residue fate* per field/location. Subsequent processing in R enables additional manipulations, e.g. to account for the 1993 ban in the UK on burning of field residues.

Further analysis in Access joins details of BSFP database tables *fertiliser application* (e.g. *fertiliser application timing*, *recorded\_fertiliser\_rate*, *farm\_id*, *nitrogen\_rate*, *field\_id*) to *field* (*field\_id*, *crop\_id*, *sown\_area\_sampled*) in order to generate outputs in terms of total nitrogen rate across year, farm and field. Subsequent calculations, combining the data on total nitrogen rate with the sown area, generates data on the total N fertiliser applied per crop; data range checks are used to automatically QC the raw BSFP data, e.g. to exclude locations where the reported nitrogen rate is either zero or spuriously high.

Using the latest JAS/C data in conjunction with the BSFP, an updated farm stratification is calculated using crop and grass sector groupings and the holding count survey weights.

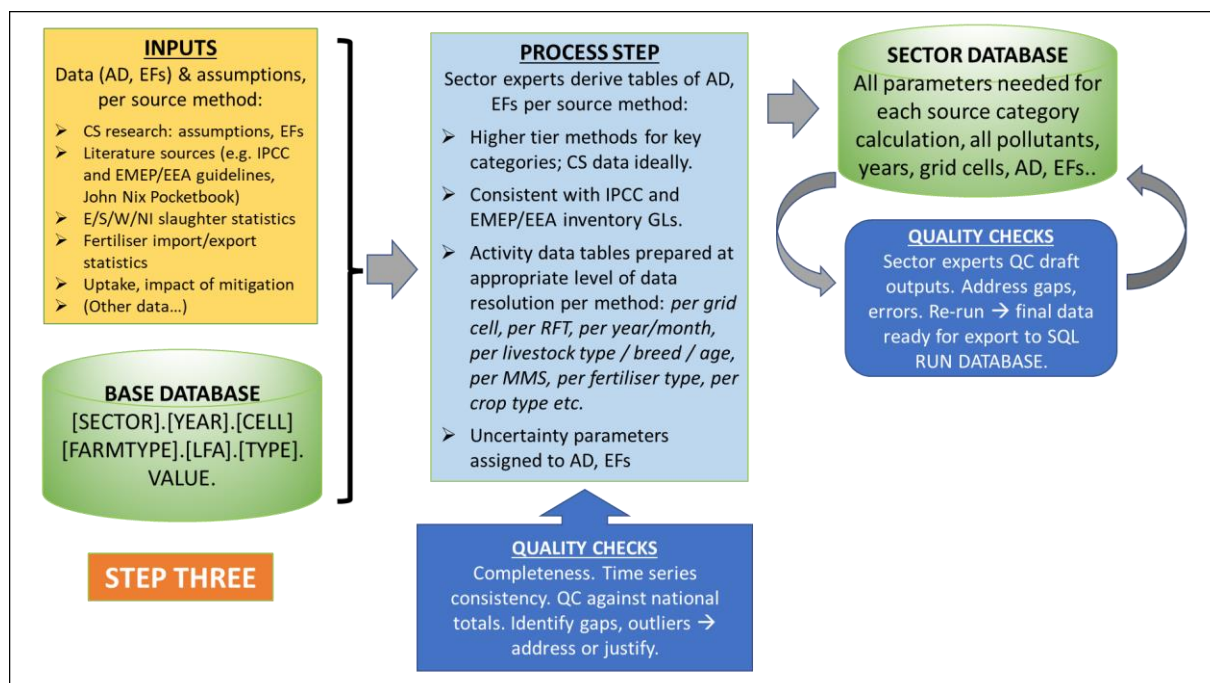
### A 3.3.7.15 Compilation of Activity Data Tables per Source Category

The next step in the inventory model data flow is for sector experts to compile the necessary activity data tables that the coded model then draws on to generate the emission estimates. Each source category method requires a set of data tables with clearly defined data fields populated for all years, countries, farm types and other sub-categories as appropriate. The sector leads draw upon the pre-processed sector datasets from the annual surveys described above. In many cases the task is merely to populate the tables for the latest year, check for any revisions to historic data, check for any new source-category combinations and run quality checks per DA, per farm type etc to ensure completeness and time series consistency, identifying and resolving any gaps or outliers. For some source sectors there is more analysis needed to review the latest year data and aggregate data or gap-fill, for example where the latest annual survey data for a specific activity may be missing or there are insufficient data records from the latest survey to regard the available data as representative.

The methods applied per sector are not described in detail here; additional information can be provided upon request. Each source category method is described within a “sector recipe” developed during the process of establishing the new inventory system. The majority of this phase of data processing is performed in MS Excel, although increasingly the data cleansing and gap-filling is being performed in code such as R scripts.

*The schematic below summarises the data processing steps to generate Activity Data tables and the Sector Database, ready for subsequent emission calculations.*

**Figure A 3.6 Inventory Model Data Flows: Source AD to Sector Database**



Examples of the Activity Data tables completed per sector and source category are as follows:

- **Arable**
  - B1 Crop Base: Year / Country / Cell / Farm type / LFA Status / Crop Type / Area
  - B2 Crop Holding Count: Year / Country / Cell / Farm type / Holding Count
  - CT10 Crop Primary Yield: Year / Country / Month / Crop / Yield



- CT14 Residue Fate: Year / Country / Farm Type / Crop / Fate Type / % Residue Area Fate
  - CT21 Fertiliser Rate: Year / Country / Farm Type / Crop / Fertilising Type / Fertiliser Rate
  - CT22 % Fertilising: Year / Country / Farm Type / Crop / Fertilising Type / % Fertilising Type
  - CT23 % Fertiliser Type: Year / Country / Farm Type / Crop / Fertilising Type / % Fertiliser Type
  - CT24 Fertiliser Timing: Year / Country / Month / Crop / % Weight Month
  - CT25 Nitrification Inhibition Uptake: Year / Country / Farm Type / Fertiliser Type / % Uptake
  - CT27 Urease Inhibitor Uptake: Year / Country / Farm Type / Fertiliser Type / % Uptake
  - CT28 Urease Inhibition N<sub>2</sub>O / CH<sub>4</sub> / NH<sub>3</sub>: Fertiliser Type / % Reduction
  - CT29 Cover Crop Uptake: Year / Country / Farm Type / % Area Cover Crops
  - CT34 Fertiliser Placement Uptake: Year / Country / Fertiliser Type / % Uptake
- **Sheep**
    - Sheep Count: Year / Holding / Sheep Type / Count
    - Lamb Type: Year / Country / Sheep System Type / Lamb Type / % Lamb Type
    - Ram Type: Year / Country / Sheep System Type / Ram Type / % Ram Type
    - Ewe Type: Year / Country / Sheep System Type / Ewe Type / % Ewe Type
    - Lamb Slaughter Age: Year / Country / Sheep System Type / Lamb Type / Lamb Slaughter Age
    - Ewe Replacement Rate: Year / Country / Sheep System Type / % Annual Replacement Rate
    - Ewe Lambing Rate: Year / Country / Sheep System Type / % Ewe Lambing Rate
    - Sheep (Latest Year): Year / Holding / Sheep Type / Country / Count
    - Sheep Compost Manure Uptake: Year / Country / Farm Type / Compost Manure Uptake
    - Sheep Cover Manure Uptake: Year / Country / Farm Type / Cover Manure Uptake
    - Sheep Winter housed: Country / System Type / % Winter Housed
    - Sheep Diet Type: Year / Country / System Type / Sheep type / Sheep Subtype / Diet Type
    - Sheep Sub-Type: Country / System Type / Sheep Type / Sheep Subtype / % Sheep Subtype
    - Sheep System Type: Country / LFA Status / Sheep System Type / % System
    - Sheep System by Sheep Type: Country / LFA Status / Sheep type / System Type / % System

Sector leads manage the compilation and checking of these Activity Data tables, including (where appropriate) to check the AD against other sector experts across the UK Inventory Agency, including:

- Total cropland and grassland land areas per DA applied within the agriculture inventory model are checked against the data used by the UKCEH team that compiles the Land Use, Land Use Change and Forestry (LULUCF) source and sink emission and removal estimates;
- Poultry litter fate data are checked with the Ricardo team that derives estimates of poultry litter incineration;
- Sewage sludge applied to land estimates in the agriculture model are checked against the data available from water companies which are managed by the Ricardo waste sector experts;

Sector leads then share the final Activity Data tables to the team at ADAS that manages the central C# agriculture model. Further quality controls are then conducted by ADAS to ensure that all Activity Data tables have a consistent and complete number of data field entries, for example:

(i) numeric checks that the number of AD table rows are as expected per table, for the latest year as per historic years; (ii) checks that new data combinations (e.g. new breeds, crops) are handled consistently and – where appropriate – are reported across the time series. Any issues identified through this central QC step are communicated back to the sector leads, resolved and documented, and the tables re-submitted.

The finalised sectoral Activity Data tables are collated together with a Sector Database, ready for the subsequent stages of emission calculations to be performed.

### A 3.3.7.16 C# Inventory Model Calculations → Source Category reporting outputs

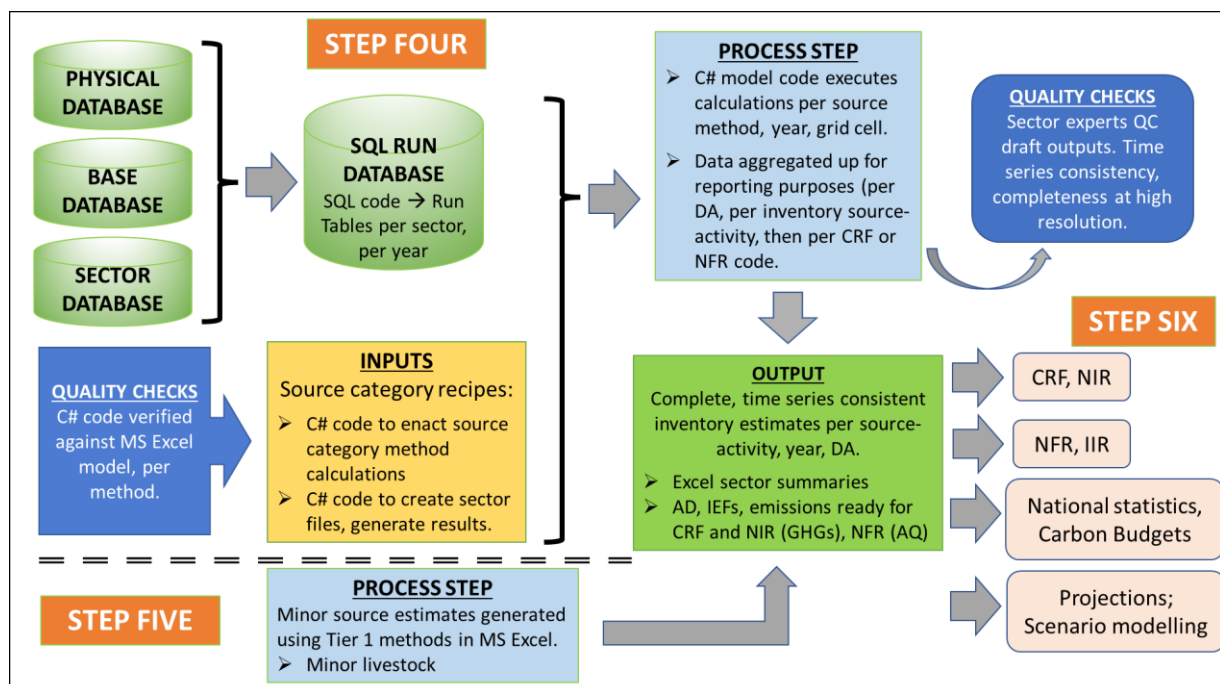
Once these iterative AD input table checks are completed, the ADAS team combines the key inputs from the Physical Database (*soil, temperature, rainfall*), Base database (*geo-spatial referencing*) and Sector database (*activity data tables per source category*) to prepare an SQL run database. The individual sector recipe calculations are stored in code (C#); these calculations have been developed and tested through a series of projects during the 2010s to model the higher-Tier inventory methods, consistent with IPCC guidelines (for GHGs) and EMEP-EEA guidelines (for AQ pollutants).

The sector calculations are run to generate sector files, executing calculations per source, per year, per grid cell and then aggregating for quality checking (and reporting) purposes to DA level, per inventory source-activity; these outputs can then be aggregated for reporting to the required taxonomy, such as CRF tables (for GHGs), NFR tables (for AQ pollutants) or to UK national statistics and other (e.g. Net Zero Strategy) reporting formats.

The individual sector recipes are not presented here; in all cases the code enacts the scientific method that is described within the National Inventory Report (for GHGs) and the Informative Inventory Report (for AQ pollutants, including ammonia (NH<sub>3</sub>)).

*The final stages of inventory compilation data flows are summarised in the schematic below.*

**Figure A 3.7 Inventory Model Data Flows: SQL Run Database to Outputs**



The C# model run outputs are circulated to each of the sector expert teams per source category and a round of further implementation quality checks are conducted, including, per source category, per DA:

- Time series consistency checks, to identify any gaps or outliers and to check the reported level of activity and emissions in the latest year;
- Completeness checks, i.e. to ensure that emissions data are coming through for each component of the source category, e.g. for each crop type, livestock type / subtype, fertiliser type etc.;
- Implied Emission Factor (IEF) checks; range checks and QC (where applicable) against the ranges presented in IPCC/EMEP-EEA guidebooks for priority pollutants such as methane, nitrous oxide and ammonia (NH<sub>3</sub>);
- Recalculation checks, to identify and check or justify the reasons for changes in historic inventory emissions data; where there have been changes to the scientific methods, input data and /or assumptions in the methods, these are documented by the sector leads for onward reporting within the NIR, IIR and other outputs (e.g. DA inventory reports).

Once the inventory data per source category-pollutant are checked and signed off by the sector expert leads, the source category estimates are compiled into summary files for onward reporting within the UK inventory system. The inventory data are subsequently used for national and international reporting outputs and are also used as the starting point for policy-focused analysis and tools; for example, the inventory data are used to underpin GHG and air quality pollutant projections and are used within UK Government analytical mechanisms such as regional-scale AQ pollutant dispersion modelling and the Defra mitigation policy-focused Scenario Modelling Tool (SMT).

### **A 3.3.7.17 Output Viewer and Scheduler files**

Whilst the fully-detailed outputs at high resolution (per year, per DA, per source, per livestock type, per RFT etc.) are held in sector output databases, these files are very large in size and not readily useable by inventory data users, e.g. within Government statistics and policy teams. Therefore, the UK agriculture inventory data are synthesised into simpler summary files, typically by aggregating outputs per pollutant per source-category and per activity, aligned to the various required reporting taxonomies, e.g. IPCC source categories for GHGs, NFR categories for ammonia (NH<sub>3</sub>) and other AQ pollutants, Net Zero Strategy categories for UK national GHG statistical outputs and so on. To facilitate access to the dataset, more user-friendly tools have been developed to allow policy leads to explore the data via an Output Viewer, whilst sector leads typically conduct their quality controls on tabulated data within Scheduler files.

The Scheduler is a macro-enabled set of MS Excel workbooks that summarise the timeseries of key outputs from the Inventory. It uses as input a set of template reports, which are generated from the output files from the model runs, by the 'Output Viewer' tool and is set up so that it specifically:

- a) Converts units, e.g. from kg N<sub>2</sub>O-N to kt N<sub>2</sub>O
- b) Summarises information by NAEI CRF and NFR reporting codes;
- c) Calculates 'implied' emission factors (IEFs) to help check the time series of source emission calculations and identify outliers;
- d) Summarises both the Activity Data and Emissions.

It's a tool that re-formats the model output into a 'standardised' set of inputs ready for summary and upload into the National Atmospheric Emissions Inventory (NAEI) database. The NAEI is the central database, managed by Ricardo as the DESNZ-funded Inventory Agency, that holds AD and EFs from all sectors and source categories (i.e. across Energy, IPPU, Agriculture, LULUCF,

Waste and Other) and is the central repository of all inventory data required for UK and sub-national reporting outputs for GHGs and AQ pollutants.

### **A 3.3.7.18 UK Agriculture Inventory Model QA/QC System and Approach**

The UNFCCC Reporting Guidelines for Annex 1 country submissions of national GHG inventories set out the expectations for the transparency of reporting of national models used in higher-tier methods. Further, in recent UNFCCC expert reviews of the UK inventory the review teams have encouraged the UK to present more information regarding model quality assurance; this section summarises how the UK is addressing these requirements.

The guidelines<sup>23</sup> note that Annex 1 parties **shall** include the following in the NIR:

*“Descriptions, references and sources of information for the specific methodologies, including higher-tier methods and models, assumptions, EFs and AD, as well as the rationale for their selection. For tier 3 models, additional information for improving transparency.”*

The UK inventory submission, within the NIR chapter for Agriculture, presents all of the necessary information to cover the above requirement, i.e. regarding data sources, assumptions, methods, algorithms etc. This is evidenced by the fact that UNFCCC expert review team findings relating to the model QA documentation are noted in the recent Annual Review Reports as “*not an issue*” and any suggested improvements to model documentation are cited as an “*encouragement*” rather than a more formal (i.e. mandatory requirement) “*recommendation*”. That said, the UK NIR chapter will continue to be revised and improved, as within the latest 2023 submission based on an extensive review of several Annex I countries NIRs, where we have added numerous flow charts, graphs and further information to provide UK evidence regarding methods, EF selection etc, and also to illustrate the quality controls that are implemented across the compilation cycle.

Footnote 12 of the UNFCCC Reporting Guidelines clarifies that parties **should** also report on:

*“The basis and type of model, application and adaptation of the model, main equations / processes, key assumptions, domain of application, how the model parameters were estimated, description of key inputs and outputs, details of calibration and model evaluation, uncertainty and sensitivity analysis, QA/QC procedures adopted and references to peer-reviewed literature.”*

In addition to these requirements driven by international reporting obligations, the UK Government (DESNZ, formerly DECC) *QA Guidance for Models*<sup>24</sup> sets out further modelling good practice guidance to help ensure that models are transparent and present information to enable users to assess the level of risk, for example regarding data inputs and assumptions applied.

Regarding adherence to the UNFCCC Guidelines, the **Agriculture chapter of the UK National Inventory Report** presents the following components:

- ✓ Descriptions, references and sources of information for the specific methodologies, including higher-tier methods and models, assumptions, EFs and AD, as well as the rationale for their selection.
- ≈ For tier 3 models, additional information for improving transparency.
- ✓ Main equations / processes, key assumptions, description of key inputs and outputs, uncertainty analysis.

The UK will continue to improve the information presented in the NIR, noting that there is scope for providing more detail regarding some of the underlying *data and assumptions* and the *rationale for their selection*; for example, **within this annex**, we now present more details regarding the

---

<sup>23</sup>

[https://unfccc.int/files/meetings/warsaw\\_nov\\_2013/application/pdf/sbsta39\\_i11c\\_14nov\\_1800\\_annex.pdf](https://unfccc.int/files/meetings/warsaw_nov_2013/application/pdf/sbsta39_i11c_14nov_1800_annex.pdf)

<sup>24</sup> <https://www.gov.uk/government/collections/quality-assurance-tools-and-guidance-in-decc>

data applied within the UK methods for recent years regarding the uptake of mitigation practices in the UK inventory calculations.

The NIR chapter includes an overview of the tier 3 models that are used, and we have now included additional graphs (e.g. to justify the country-specific EFs applied) and flow charts to illustrate the QC for some of the more complex models, e.g. the N-flow model used across the livestock MMS. This is in direct response to the ERT comments from the review of the 2022 submission. *We welcome further reviewer feedback on where to focus future efforts.*

Further, **this annex** seeks to address the remaining UNFCCC QA reporting requirements, including:

- ✓ For tier 3 models, additional information for improving transparency
- ✓ The basis and type of model, application and adaptation of the model
- ✓ domain of application
- ✓ how the model parameters were estimated
- ✓ details of calibration and model evaluation
- ✓ QA/QC procedures adopted and references to peer-reviewed literature

This annex provides an overview of the model structure, software, processes and quality controls. It outlines the governance, roles and responsibilities for key stakeholders and provides an insight into the background to the development of the UK model, providing links to the more detailed individual studies conducted during the 2010s to develop the methods and country-specific methane and nitrous oxide emission factors.

Over a period of ~5 years the UK model was developed, with the development of sector-specific Activity Data table specifications and the drafting of C# code to implement the inventory methods; throughout that process, unit testing of steps within each method were conducted. The sector experts implemented reperformance checks on the C# code by running equivalent calculations conducted in MS Excel. Through this process the UK model methods were verified to be correctly performing the intended calculations. Numerous academic papers were developed and published to support and evidence this process and the selection of UK-specific parameters.

*The UK will continue to explore how to efficiently present a concise but informative summary of some of these facets of the model assurance, other than merely to provide links and references.*

### **A 3.3.7.19 Annual Inventory Quality Assurance, Quality Controls and Checks**

This section provides an overview of the approach to QA/QC across the annual cycle of agriculture inventory compilation and reporting; for specific details per source category, see the relevant section of the National Inventory Report or Informative Inventory Report.

#### **QA activities**

Through the inventory steering groups (NISC, managed by DESNZ; AQISG managed by Defra) the agriculture inventory team consults with stakeholders (including UK and DA policy leads, statisticians and researchers) on the current methods, areas of uncertainty and potential for improvements to data sources, assumptions applied and emission estimation methods.

Where potential inventory improvements are identified, the inventory team may opt to prepare draft documentation to outline the proposed data/method improvement and submit those proposals to peer reviewers, typically academic and/or agriculture sector experts from the UK or other countries with similar production systems. In the last 5 years the UK team has engaged in several peer or bilateral reviews with agriculture sector experts from countries including Ireland, Germany and Denmark.

The UK agriculture inventory team engages annually in UNFCCC Expert Review Team reviews, CLRTAP and NECR reviews as well as attending international workshops and conferences to

keep abreast of developments in other countries and identify potential improvements for the UK inventory system, data and models.

### **Quality Control and Documentation**

The agriculture sector Quality Control (checking, documentation and archiving) occurs throughout the data gathering, compilation and reporting cycle. The key activities that are undertaken and documented to check the estimates include:

**Second person checking as standard.** Throughout the compilation process, the team updates the inventory calculation, checking and reporting files via a compiler/author and then a second expert / checker to sign off the work. As we work across multiple organisations, we have developed data QA templates to accompany all data / file transfers, with a common approach to set out the compiler (name, date) and checker (name, date), data fields to log origin data files / date accessed, and a documented series of quality checks that the compiler must complete and sign off, and then the checker also. In this way we have a complete audit trail of the data sources and QC conducted through the process.

- Updated activity data tables are checked for accuracy, time series consistency and completeness at a high level of resolution (e.g. per DA, livestock type, age, grid cell) by a second person not involved in the initial data compilation.
- Draft outputs from the model are checked for completeness and accuracy by the lead sector expert, after the model runs are completed by the central team of analysts.

**Checking of input data** for scope, completeness, consistency with data for recent years and (where available) verification against other independent datasets. Compilers check the incoming data from data providers to assess whether the data are complete and consistent with data for recent years. *Specific examples are presented earlier in this annex to illustrate the specific QC of the CTS, JAS/C, BSFP etc.*

**Mass flows / balances.** The draft outputs are checked to ensure that process inputs and outputs are balanced and understood. For example, for the livestock MMS we conduct a nitrogen flow assessment to check on the origin, transfers and fate of N across the system. Sector experts check the N partitioning across different parts of the MMS systems, e.g. the fate of N across housing, storage and spreading end uses.

**Completeness checks.** The database is checked for completeness and consistency of entry across the different pollutants and gases, per DA, livestock / crop / fertiliser type etc.

**Recalculation checks.** The latest inventory dataset is compared against the previous inventory submission. Any recalculations are documented by inventory compilers and signed off by checkers. Reasons for the recalculations are documented, e.g. method improvements, revisions to input data or assumptions. These recalculation notes are referenced within the inventory database to facilitate reporting and transparency of recalculations.

The sector leads and QA manager check that all recalculations are documented and that updates expected from previous review findings and improvement projects are completed and transparently described within reports to DESNZ and Defra, and the NIR and/or IIR.

**Time series checks and benchmarking checks.** The time series of emissions are checked for step changes, trends, and any outlier data (e.g. outlier EFs or peaks/dips in activity data trends). Any unusual features are checked and explained, with reasons for significant trends and outliers documented in the method sections of the NIR and/or IIR. Implied Emission Factors (IEFs) are checked against previous estimates and for key categories against defaults (from IPCC guidance) to identify any notable UK-specific EF outliers.

**Method implementation checks.** A range of common checks are performed across inventory calculation models, such as: checking that units are correct for input parameters; checking for

either new emission estimates (e.g. due to new UK data or new methodological guidance or new EFs within the IPCC guidance) or for any missing emission sources compared to previous submissions.

**Reporting checks.** Inventory submissions are checked to ensure correct allocation into the CRF categories. Emission totals at national and sub-category level are checked against the “master” dataset derived from the UK inventory database outputs, to minimise risks of data transcription errors into reporting templates.

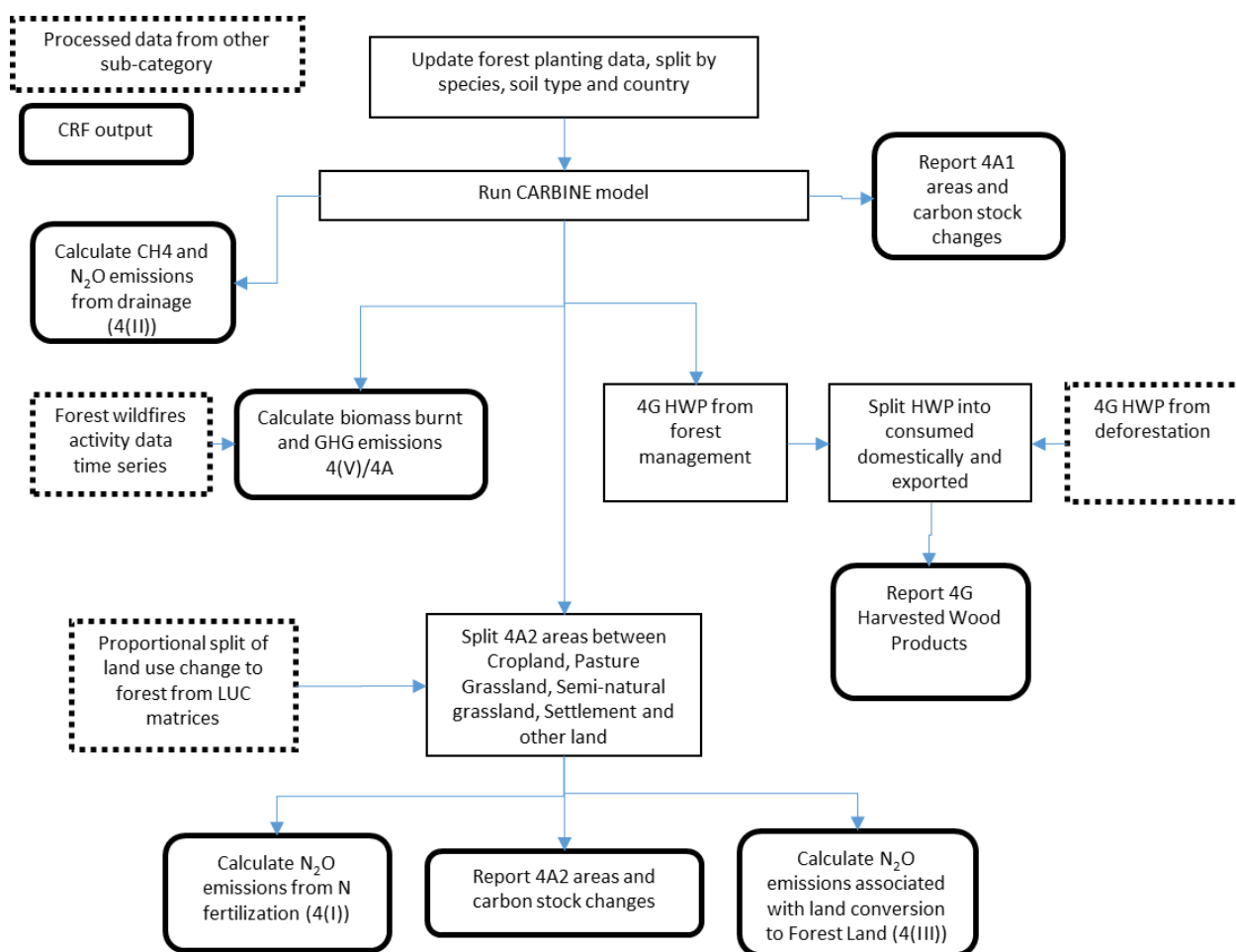
### A 3.4 LAND USE, LAND USE CHANGE AND FORESTRY (CRF SECTOR 4)

The following section describes in detail the methodology used in the LULUCF sector described in **Chapter 6**.

The flow chart below shows the interrelationships between different data sources and the main calculation steps.

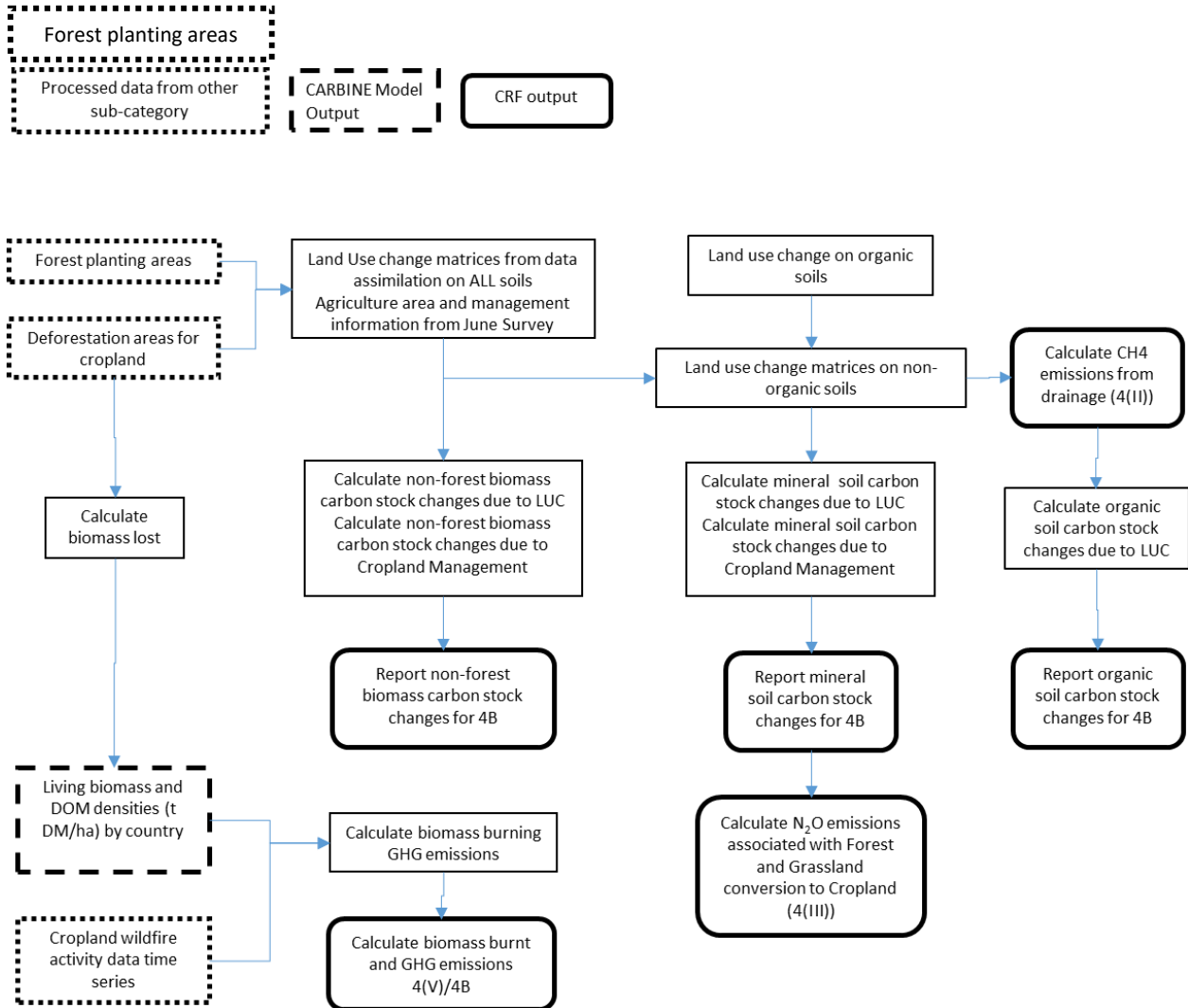
**Figure A 3.8 Data flow diagrams for each land use sub-category, showing cross-linkages between sectors: (i) 4A and 4G, (ii) 4B, (iii) 4C, (iv) 4D, (v) 4E**

(i) 4A Forest Land and 4G Harvested Wood product data flows

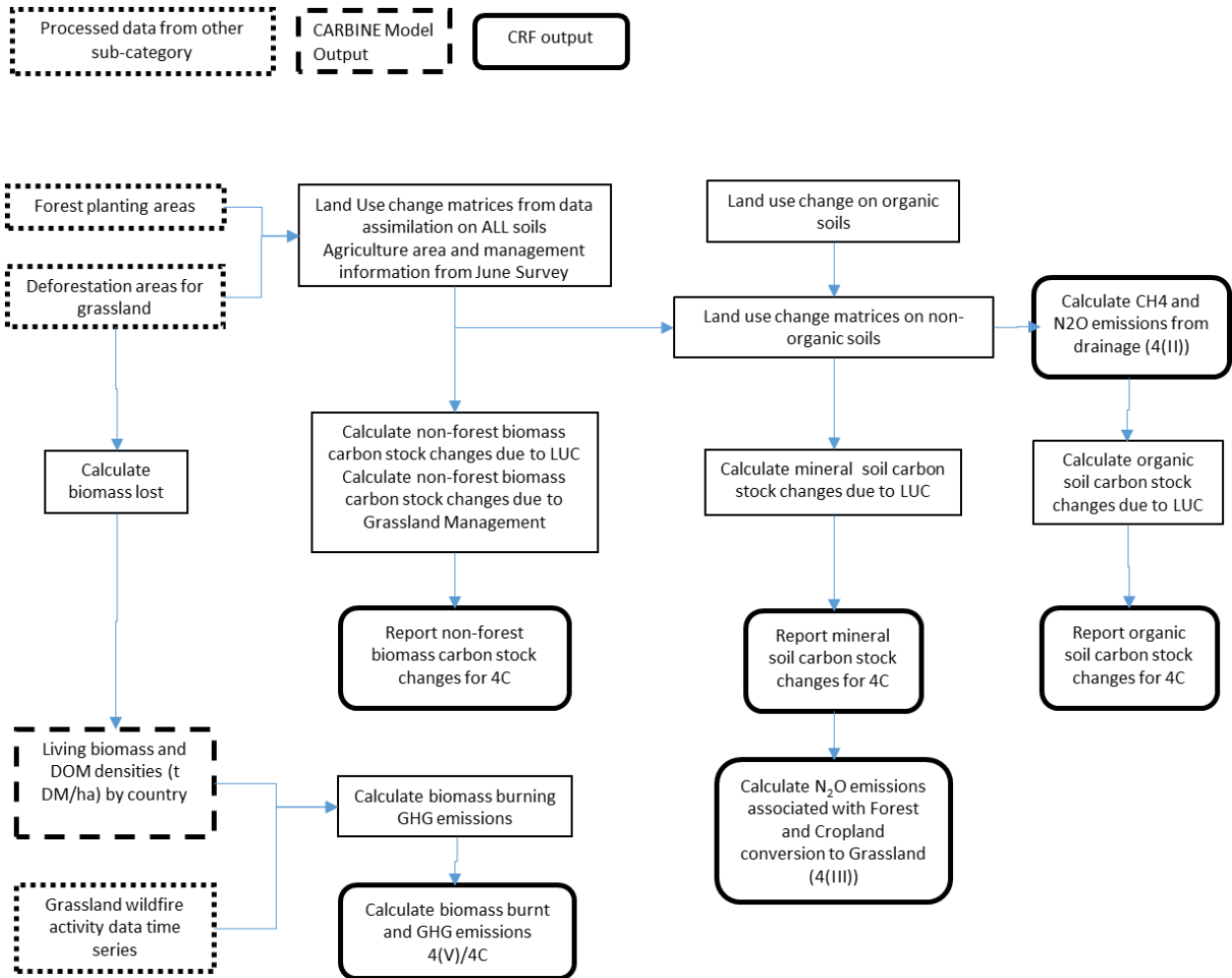




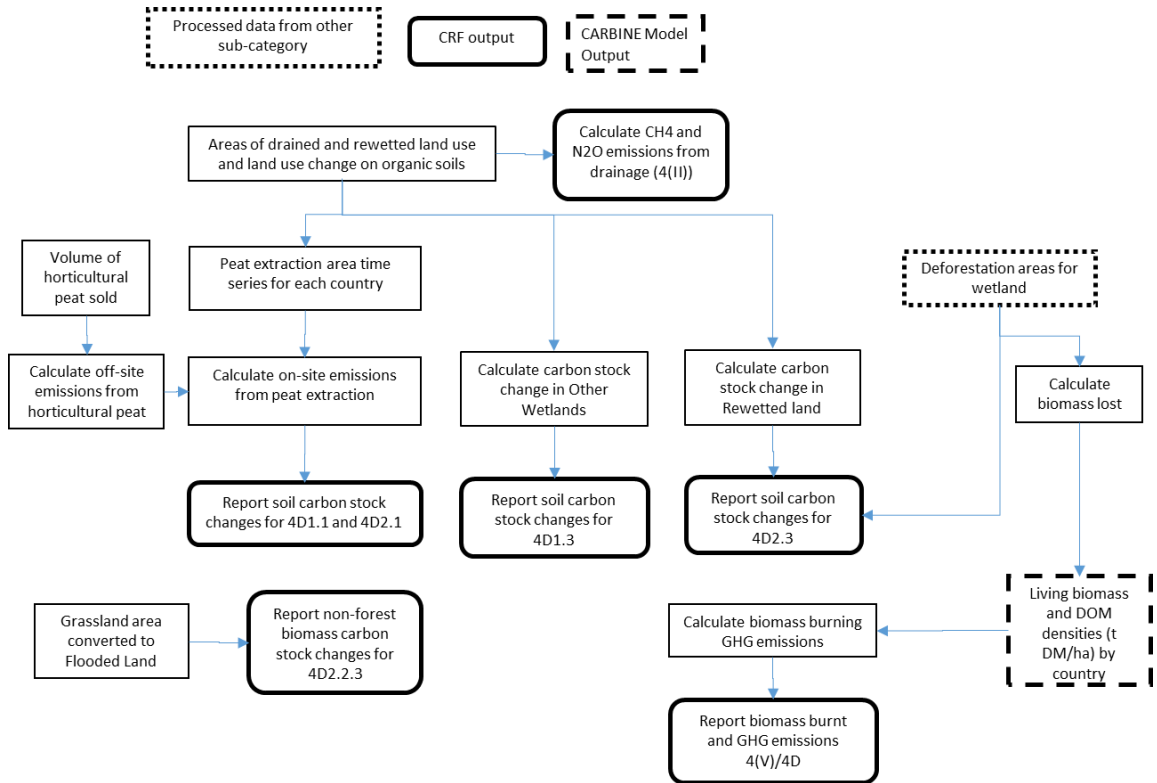
## (ii) 4B Cropland data flows



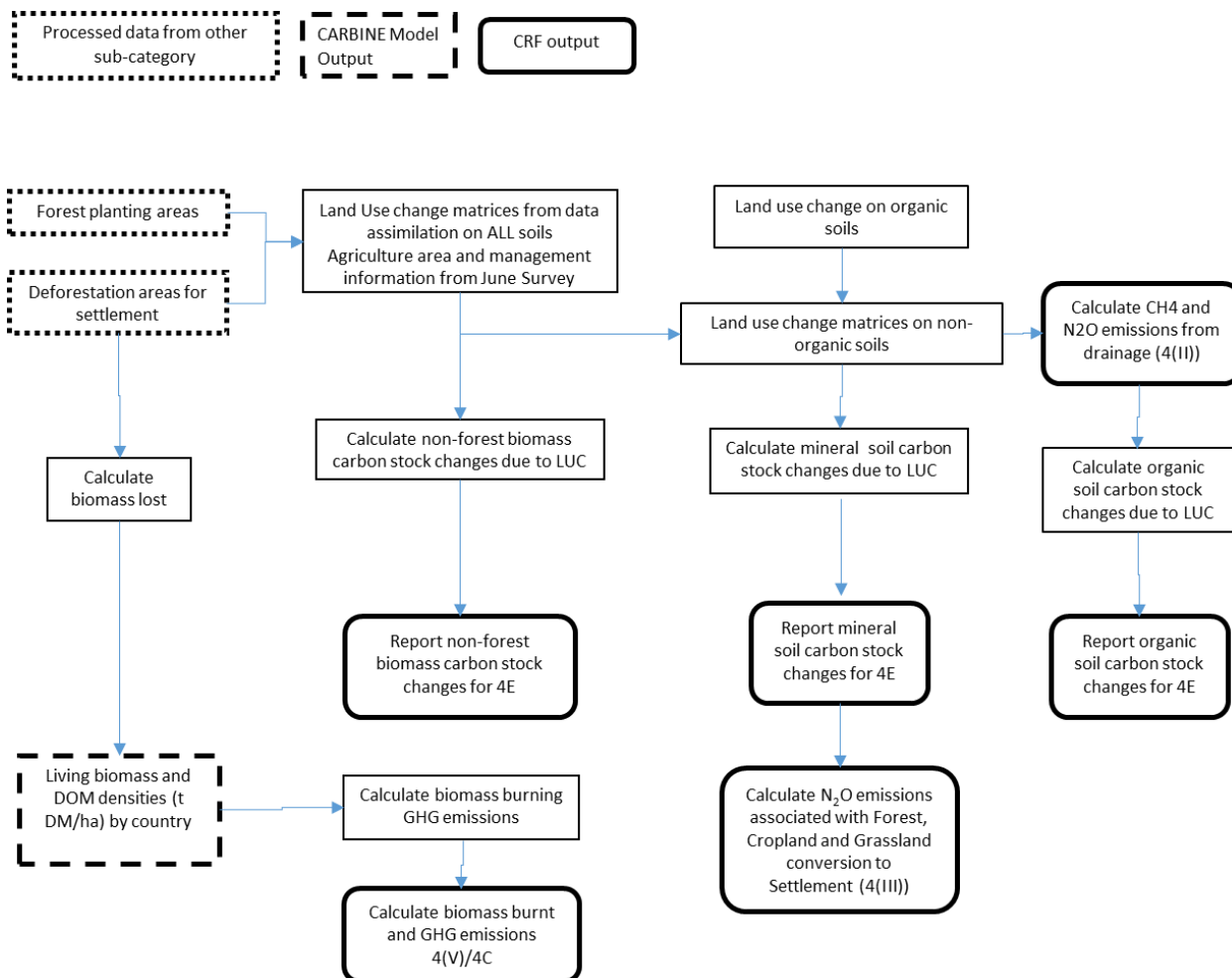
## (iii) 4C Grassland data flows



(iv) 4D Wetlands data flows



(v) 4E Settlements data flows



### A 3.4.1 Carbon stock changes due to afforestation and forest management (4A)

#### A 3.4.1.1 The Forest carbon accounting model CARBINE

Carbon uptake by the forests planted in the UK is calculated by a carbon accounting model, CARBINE, as gains and losses in pools of carbon in standing trees, litter and soil in conifer and broadleaf forests and in harvested wood products. Restocking is assumed in all forests. The method is Tier 3, as defined by IPCC (2006). **Section A 3.4.2** demonstrates how the use of this model complies with IPCC good practice criteria for the use Tier 3 models.

CARBINE simulates forest C stock changes represented by tree biomass growth, mortality and subsequent loss. The CARBINE model is primarily dedicated to reproducing the UK forest conditions.

The model as used for this inventory consists of three sub-models or ‘compartments’ which estimate carbon stocks in the forest biomass, soil, and harvested wood products. The forest biomass carbon sub-model is further compartmentalised to represent fractions due to tree stems, branches, foliage, and roots.

### A 3.4.1.1.1 Carbon in forest biomass

The main driving module of CARBINE consists of a set of computerised mathematical functions and algorithms describing the accumulation (and loss) of carbon in tree biomass of different forestry systems at the per-hectare scale. Different functions and algorithms are used to represent distinct forestry systems, defined in terms of:

- Tree species composition
- Tree growth rate (yield class)
- Management regime applied.

The tree species and growth rates represented are based on yield models originally produced by the British Forestry Commission (Matthews et al., 2016a, 2016b). The tree species covered include examples for coniferous species of spruces, pines, firs, larches, cedars, cypresses and all the major temperate and boreal broadleaf tree species. Growth rates in terms of maximum mean annual increment of stem volume ('Yield Class') can be represented in the range from 2 m<sup>3</sup> ha<sup>-1</sup> yr<sup>-1</sup> up to 30 m<sup>3</sup> ha<sup>-1</sup> yr<sup>-1</sup>.

The CARBINE model uses standard estimates for wood density wood carbon content to derive stem biomass from the stem volume predictions simulated by the M1 model (Lavers and Moore, 1983; Jenkins et al., 2011; Matthews, 1993). Wood and bark density along with the carbon content differences are not taken into account. The density of bark is lower than that of wood (Aaron, 1970), but the carbon content is usually higher (Matthews, 1993), hence it is assumed that the two effects cancel out. The biomass and carbon in tree foliage, branches, and coarse and fine roots are derived from the results for the stem by applying expansion factors. Species-specific biomass expansion factors are applied for these calculations.

The biomass of a component of interest is calculated by multiplying stem biomass by a corresponding expansion factor. The UK species-specific crown and root biomass expansion factors were derived from the report of Jenkins *et al.*, (2011) report. Branch biomass is calculated by subtracting foliage biomass from crown biomass. The coarse root biomass expansion factor includes an allowance for stump material. Robust information on foliage expansion factors relevant to UK conditions were not available, hence these were obtained from scientific literature. The ratio of foliage to stem changes over time, but approaches an asymptote (Matthews et al., 1991; Matthews and Duckworth, 2005). However, the asymptote in general is more suited to older, larger trees and as such is considered not to be representative of typical forests under regular management. It was decided to use a biomass expansion relationship for trees of approximately 20 cm diameter in order to better represent managed forests. It is likely that this will ultimately underestimate foliage biomass in smaller trees, and conversely over-estimate in older, larger trees. Finally, fine root biomass is calculated with a uniform expansion factor  $\beta_r=0.02$  from a Liski et al., (2002) study. The expansion factors are not sensitive to stand age, management regime or growth rate. This approach was adopted for the simplicity and ease of implementation on the large-scale simulations.

The mass of carbon in a forest was calculated from biomass by multiplying by the fraction of carbon in wood (0.5 assumed). As an example, the values used for these parameters for Sitka spruce (*P. Sitchensis*) are given in **Table A 3.4.1**. Sitka spruce is the most common species in UK forests (c. 30%); parameters for other tree species are given in Matthews *et al.* (2014).

**Table A 3.4.1 Main parameters for forest carbon flow model used to estimate carbon uptake by planting of forests of Sitka spruce (*P. Sitchensis*), yield class 12.**

Parameter	Value
Time of maximum mean annual increment (years)	60
Initial spacing (m)	2
First table age (years)	20
Age at first thinning (years)	25
Stemwood density (oven dried tonnes m <sup>-3</sup> )	0.33
% Stemwood conversion loss	10%
% Branchwood left in forest	100%
% Branchwood harvested for fuel	0%
% fuel from bark	30%
% non-fuel products from bark	70%
% small roundwood (underbark) used as fuel	20%
% Pallets and fencing from small roundwood (under bark)	20%
% Paper from small roundwood (under bark)	35%
% Particleboard etc. from small roundwood (under bark)	25%
% Fuel from sawlogs (under bark)	30%
% Pallets and fencing from sawlogs (under bark)	0%
% Particleboard from sawlogs (under bark)	40%
% Structural timber from sawlogs (under bark)	30%
Root:Stem ratio	0.49
Crown:Stem ratio	0.32
Foliage:stem ratio	0.13
Fine root:stem ratio	0.02
Foliage turnover rate (annual)	0.2
Branchwood turnover rate (annual)	0.04
Coarse Root Turnover rate (annual)	0.02
Fine Root turnover rate (annual)	0.8
Underbark/overbark ratio at 15cm Diameter at Breast Height (DBH) – varies with DBH	0.9
Ratio of thinned stem volume that is sawlog at 15cm DBH (varies with DBH)	0.05

#### A 3.4.1.1.2 *Dead wood and litter*

CARBINE includes a sub-model for representing accumulation and loss of carbon in dead wood and litter. Inputs of litter are related to the standing biomass of trees and to rates of tree mortality. Levels of tree mortality are represented implicitly in the standard Forestry Commission growth models, and explicit estimates are included in models for stands subject to no thinning, where mortality levels are high. Root and branch wood volume associated with dead trees is estimated in the same way as for living stemwood, by reference to allometric relationships. Deadwood and litter are assumed to decay according to a first order process, with rate constants that are normally set to be consistent with boreal and temperate conditions but can be adjusted for Mediterranean and tropical conditions. The other significant input of carbon to the dead wood and litter pool is due to harvesting operations (as part of either thinning or clear-felling). The carbon in roots of harvested trees is assumed to enter the litter pool. The harvesting of stem wood is assumed to involve a conversion loss equivalent to 10% of standing stem volume, which also enters the litter pool. It is difficult to make accurate assumptions about the fate of branch wood and foliage at time of harvesting. In many situations, this material will be left on-site to deteriorate and decay. Sometimes it is possible that branch wood remaining after clear-felling may be deliberately burned. There has also been an increasing interest in active harvesting of branch wood (or at least some proportion of it) to supply biomass to the Energy sector. However, currently, such practice remains very limited. For this inventory the assumption has been made that no branch wood is harvested but is left to degrade and decay on site as part of the litter pool.

The branch Annual Turnover Rate (ATR) was fixed at 4% in accordance to Canadian forest carbon accounting model CBM-CFS (Kurz et al., 2009). Deciduous species foliage turnover is assumed to be 100% (Kurz et al., 2009; Ľupek et al., 2015). Conifer species foliage ATRs were obtained by referring to relevant scientific literature. If insufficient empirical literature and data was available, the species were mapped to an allometrically similar species. Coarse root annual turnover was assumed to be 2% as in the CBM-CFS (Kurz et al., 2009; Kurz and Beukema, 1996; Li et al., 2003). Fine root ATRs were mapped from the available scientific literature and the UK specific datasets provided by Vanguelova (pers. com.). The UK ATRs for fine roots were derived from Kielder forest for Sitka spruce and Alice Holt forest for oak. Lastly, root exudate ATR was set to 160% of fine root dry biomass, the upper quartile of reported exudate mass from grassland was adopted (Jones et al., 2009), because of limited understanding about forest rhizodeposition. Aboveground shed litter, foliage and branches, are accumulated in a litter layer and after partial degradation passed to the Fermenting (F) layer. Residues that are left after thinning or felling can be set to enter a litter layer. If the crop is not a forest, it is assumed that the litter and F layers are zero. The litter layer decomposition is modelled using modified ForClim-D model version (Liski et al., 2002; Perruchoud et al., 1999). Belowground litter is not included in this simulation, while the annual transfer rates are applied to foliage ( $C_f$ ) and branch ( $C_b$ ) litter biomass. They are expressed as a proportion relocated annually.

Branch and foliage litter transfer are set according to the model proposed by Liski et al. (2002). The transferred biomass is pooled and degraded by a fixed constant of 0.5, which is the average of constants given in the Liski et al. (2002) study.

#### A 3.4.1.1.3 *Soil carbon*

The CARBINE Soil Carbon Accounting model (SCOTIA, formerly referred to as CARBINE SCA; **Figure A 3.9**), is based on a simplified version of the ECOSSE model (Smith *et al.*, 2011), coupled with a litter decomposition model derived from the ForClim-D model (Perruchoud *et al.*, 1999; Liski *et al.*, 2002). Above-ground turnover of material such as foliage, branches and dead

stemwood enters the litter pool, which is then broken down to F-material (Fermenting) as a function of temperature and rainfall, releasing CO<sub>2</sub>. Within the soil, a number of layers exist, each with its own set of texture (Sand, Silt, Clay) characteristics. Carbon from decayed litter, dead roots, and root exudates enters each layer and is assigned to four active pools; resistant plant material (RPM), readily decomposable plant material (DPM), biological material (BIO) and humic material (HUM). A proportion of organic carbon is also assumed to be inert, and unavailable for further activity. The active pools undergo decomposition and transference, releasing CO<sub>2</sub>. Decomposition (aerobic and anaerobic) within each pool and layer is influenced by response functions to water saturation in the soil, temperature, pH, and the presence (or not) of plant cover on the soil surface. The availability of water within each layer, and the level of saturation are largely defined from soil texture following Saxton and Rawls (2006) coupled with inputs from rainfall, (or drainage) and removal of water through evapotranspiration. In any soil layer, water above field capacity can drain to lower soil layers, complete with any dissolved organic carbon (DOC). The rates of potential decomposition of each carbon pool and the response functions follow ECOSSE (Smith et al., 2011).

New carbon input to the soil arises from four sources:

- Recently dead root material (according to a rooting profile depth),
- Transfer from the F-material arising from the decomposition of above-ground litter,
- Secretions and exudates from the roots,
- DOC; this carbon can become available to the biological pool and enter the 'reactive material cycle'.

Turnover rates for mortality of tree components (roots, foliage etc.) are species dependent and obtained from scientific literature (see **Table A 3.4.1** for example).

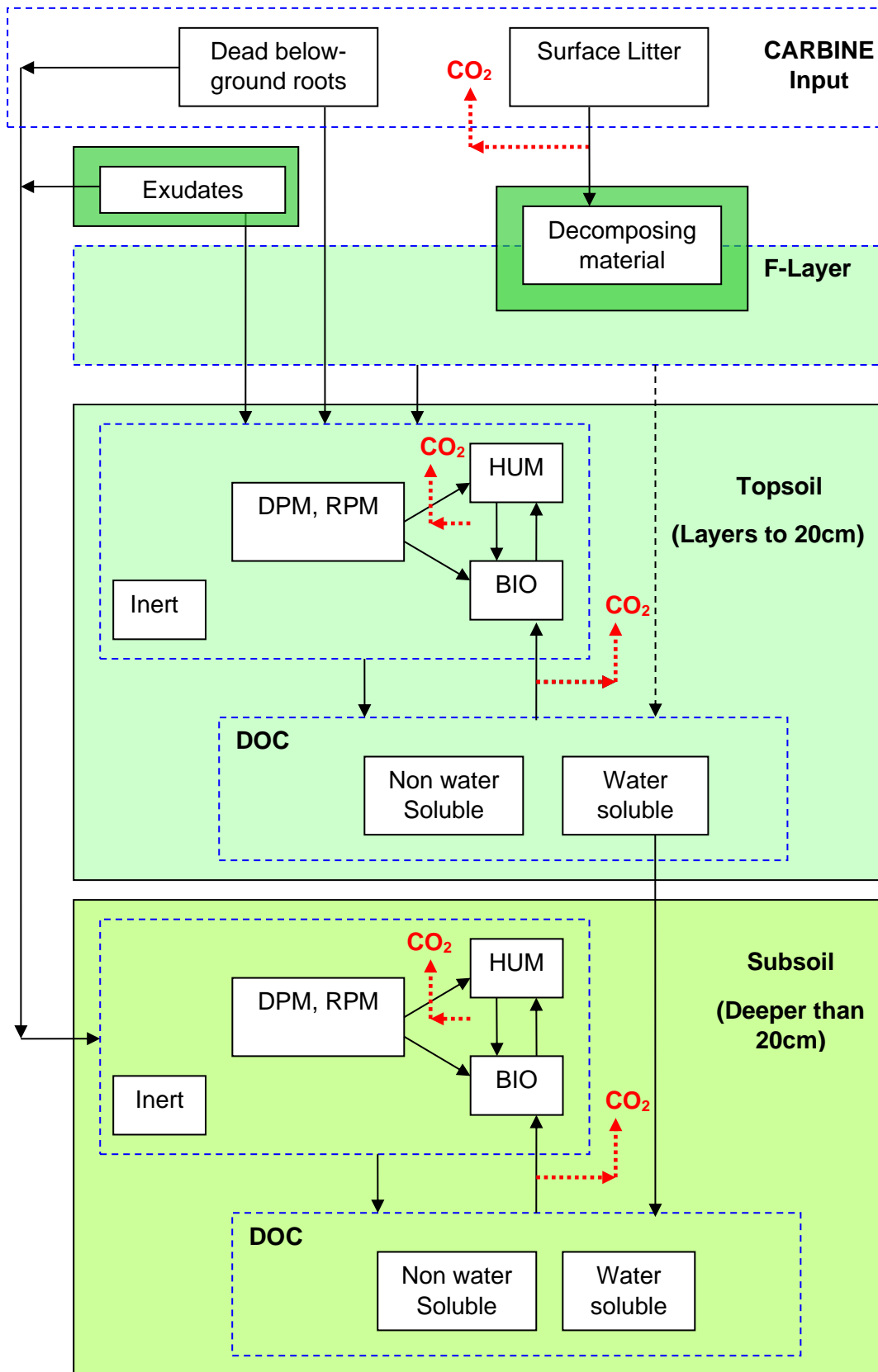
An improved version of the soil sub-model was implemented for the 1990-2016 inventory. This included work on parameterisation of litter input from ground flora and other non-forest vegetation, assuming a decrease in the contribution of non-tree litter from 60% of the carbon input assumed in ECOSSE for pasture to zero contribution at canopy closure, after an initial year of clearance of vegetation on planting.

A more comprehensive description of the soil sub-model will be described in a technical report.

Additional pathways in which carbon is lost from organic soil include waterborne export of DOC and particulate organic carbon (POC) from drained organic soils, which is related to land use disturbances (erosion, burning), and drainage ditches. The off-site CO<sub>2</sub> emissions from the decomposition of POC and DOC exported from drained organic soils are calculated separately using Tier 1 and 2 approaches (see Evans et al 2017 and **Section A 3.4.7**).



Figure A 3.9 The CARBINE SCOTIA model



### A 3.4.2 Alignment of CARBINE to the IPCC suggestions for “Use of Models in Good Practice National Greenhouse Gas Inventories”

The IPCC has published suggestions on the approach to implementing good practice in the use of models<sup>25</sup> in national GHG inventories. These suggestions are provided in “*Use of Models and Facility-Level Data in Greenhouse Gas Inventories. Report of the IPCC Expert Meeting on Use of Models and Measurements in GHG Inventories, 9-11 August 2010, Sydney, Australia*”. Chapter 3 provides a bullet point list of the key elements of a model that can be used to guide the description provided by inventory compilers of the modelling approach they use. Providing this detail increases the transparency of the methodological description.

**Table A 3.4.2** is based on this bullet point list, and summarises the methodological approaches used in CARBINE for each of the elements, or criteria, and provides references to where further information can be found.

**Table A 3.4.2 Compliance of the CARBINE model with the IPCC criteria on the use of models**

Criteria (or element)	Reference to documentation
<b>Basis and type of model</b>	<p><b>Summary</b></p> <p>Carbon change in the forests of the UK (meeting the UK definition of forest for inventory purposes) is calculated by a carbon accounting model, CARBINE, as the sum of gains and losses in pools of carbon in vegetation, litter and soil in conifer and broadleaf forests and in harvested wood products. Restocking is assumed in all forests. The method is Tier 3, as defined by IPCC (2006).</p> <p><b>References</b></p> <ul style="list-style-type: none"> <li>• UK NIR: Annex 3.4.1. Carbon stock changes due to afforestation and forest management (4A); Section 6.2. CATEGORY 4A – FOREST LAND; Section 6.8. CATEGORY 4G – HARVESTED WOOD PRODUCTS</li> <li>• Matthews et al. (in prep). The CARBINE model. A technical description Chapter 2. Modelling purpose and scope</li> </ul>

<sup>25</sup> In the application of models in National Greenhouse Gas Inventories, critical issues are suitability, parameterization, calibration, evaluation, and uncertainty.

Criteria (or element)	Reference to documentation
<p><b>Application and adaptation of model</b> <i>(description of why and how the model was adapted for conditions outside the originally intended domain of application)</i></p>	<p><b>Summary</b></p> <p>The CARBINE model was first developed by the then Research Division of the Forestry Commission in 1988 (Thompson and Matthews, 1989), now Forest Research. It is built around the stand level M1 growth and yield model which is based on yield tables published in the early 80s (see Arcangeli and Matthews). The general purpose of the CARBINE model is to address questions about the carbon and GHG balances of forestry systems, and to inform the development of forest policy and practice, particularly regarding the goal of climate change mitigation. It was adapted for use specifically with the UK GHG inventory and first used in the GHG inventory submitted in 2014. The UK replaced the C-FLOW model with CARBINE because CARBINE has several advantages which allows it to more accurately estimate GHG emissions and removals. CARBINE can model a more diverse range of species and forest management practices, and model complex changes or trends in forest management over time. It also addresses a key limitation of C-FLOW, which assumed that forests planted prior to 1921 were at carbon equilibrium. Matthews et al. (2014) gives an overview of the CARBINE model and a comparison of its use in the 1990-2012 LULUCF inventory with the C-Flow model previously used model to forest carbon stock changes.</p> <p>The growth conditions of forests represented by CARBINE are principally of relevance to UK forest conditions. The CARBINE model is not operating outside its originally intended domain of application.</p> <p><b>References</b></p> <ul style="list-style-type: none"> <li>• UK NIR. Annex 3.4.1. Carbon stock changes due to afforestation and forest management (4A); Section 6.2. CATEGORY 4A – FOREST LAND; 6.8 CATEGORY 4G – HARVESTED WOOD PRODUCTS</li> <li>• Matthews et al. (in prep). The CARBINE model. A technical description. Chapter 2. Modelling purpose and scope</li> <li>• Thompson, D.A., Matthews, R.W., 1989. The storage of carbon in trees and timber. Forestry Commission Research Information Note 160. Forestry Commission: Edinburgh</li> <li>• Matthews, R., Malcolm, H., Buys, G., Henshall, P., Moxley, J., Morris, A. and Mackie, E. (2014) Changes to the representation of Forest Land and associated land-use changes in the 1990-2012 UK Greenhouse Gas Inventory. Forest Research and Centre for Ecology and Hydrology (DECC Contract GA0510, UKCEH Contract no. NEC0376)</li> </ul>
<p><b>Main equations / processes</b></p>	<p><b>Summary</b></p> <p>The CARBINE model is a complex model, with several sub models. These sub-models include: forest carbon sub-model, soil sub-model, SCOTIA, and wood products sub-model. The forest carbon and soil sub-models are used in the GHG inventory and the latest UK NIR provides a summary of CARBINE model.</p> <p>Forest Research are working on a report which documents the methods employed in the implementation of the CARBINE forest sector carbon accounting model. The report includes model equations, parameters, assumptions, verification and supporting scientific evidence, where available. Figure 2.2 in that report presents a schematic representation of the structure and components of CARBINE.</p> <p><b>References</b></p> <ul style="list-style-type: none"> <li>• Matthews et al. (in prep). The CARBINE model. A technical description. Chapter 3. Representation of forest stands; to; Chapter 4. Representation of harvested wood products; and; Annex 1. Detailed soil carbon model description</li> <li>• UK NIR: Annex 3.4.1. Carbon stock changes due to afforestation and forest management (4A)</li> </ul>

<p><b>Key assumptions</b> (important assumptions made in developing and applying the model)</p>	<p><b>Summary</b></p> <p>The CARBINE model is a complex model, and only a summary of the key assumptions can be given here. A key concept of the methodology underlying the CARBINE model is that net exchanges of carbon between forest pools (trees, deadwood, litter and soil) and related pools (deforestation, HWP) can be inferred from the changes in the carbon stocks of these individual pools. The section numbers in the description below refer to the sections in Matthews et al. <i>The CARBINE model. A technical description</i>:</p> <p style="text-align: center;"><b>3.1. Stand volume growth.</b></p> <p>The main assumption is that all types of forests and management in the UK can be represented by the FC yield models – including by assuming that species not covered by the UK yield tables can be mapped to a species for which a model is available.</p> <p>Immediate restocking is assumed in all forests.</p> <p style="text-align: center;"><b>3.2. Stand stem biomass and carbon.</b></p> <p>The key assumption is that stem merchantable biomass can be calculated from stem volume from the yield tables using a species-specific stem density and a country-specific estimate of carbon content for all wood (50%)</p> <p style="text-align: center;"><b>3.3. Stand tree biomass and carbon.</b></p> <p>The key assumption is that the stem biomass can be converted to whole tree biomass using biomass expansion factors for branches, leaves, coarse roots and fine roots.</p> <p style="text-align: center;"><b>3.4. Stand management.</b></p> <p>Forest stand management is represented by four broad prescriptions: 1) No thinning and no felling (i.e. effectively no management for production); 2) Clear-felling on a specified rotation without thinning; 3) Thinning with clear-felling on a specified rotation; 4) ‘Continuous cover’ silviculture (i.e. woodland management with harvesting based on thinning only, that also aims to always maintain tree cover on the land).</p> <p style="text-align: center;"><b>3.5. Stand disturbance events.</b></p> <p>The key assumption for the inventory is that there will be no mortality beyond the normal senescence of part of tree and within stand competition as predicted by the yield model as calibrated on the permanent sample plots. Supplementary calculations are carried out for the purposes of reporting relevant GHG emissions as part of GHG inventories for disturbances from fires on Forest Land.</p> <p style="text-align: center;"><b>3.6. Tree harvesting in stands.</b></p> <p>The assumption is that the harvesting is as modelled in the yield tables and that only certain parts of the tree are removed – i.e. there is no whole-tree harvesting.</p> <p style="text-align: center;"><b>3.7. Losses of carbon from parts of living trees through senescence.</b></p> <p>The key assumptions are that deadwood and litter inputs in the form of losses of branches and foliage from living trees can be modelled by annual turnover rates and that these losses will be replaced (i.e. that the relationships between the carbon in the different compartments implied by the biomass expansion factors still holds).</p> <p style="text-align: center;"><b>3.8. Stand deadwood and litter accumulation.</b></p> <p>Carbon enters the deadwood and litter pools through several processes:</p> <ul style="list-style-type: none"> <li>• Losses of biomass from the senescence of parts of growing trees (Section 3.7)</li> <li>• Mortality of trees as a result of stand competition (Sections 3.2 and 3.3)</li> <li>• Mortality of trees as a result of stand natural disturbance (Section 3.5)</li> <li>• Tree biomass discarded in the forest during harvesting operations (Section 3.6).</li> </ul> <p>Carbon is lost from the deadwood and litter pools through decomposition.</p> <p style="text-align: center;"><b>3.10. Soil carbon (including fermenting material).</b></p> <p>That the soil carbon and fermenting material can be represented using an “ECOSSE-style model”. This model, called SCOTIA, was developed to allow full representation of UK specific conditions, including both mineral and organic soils.</p>
---	---

Criteria (or element)	Reference to documentation
	<p style="text-align: center;"><b>4.1. Representation of Harvest Wood Products.</b></p> <p>While a more disaggregated description of HWP is available in CARBINE, for the purpose of the Convention reporting, wood products are grouped in a more limited set of semi-finished product categories consistent with the IPCC guidelines and modelled using first order decay functions and product half-lives specified as part of Tier 1 methods in the IPCC good practice guidance.</p> <p>The summary above of the key assumptions increases the transparency of the of the CARBINE model.</p> <p><b>References</b></p> <ul style="list-style-type: none"> <li>• Matthews et al. (in prep). The CARBINE model. A technical description. Chapter 3. Representation of forest stands; to; Chapter 4. Representation of harvested wood products</li> <li>• UK NIR: Annex 3.4.1. Carbon stock changes due to afforestation and forest management (4A)</li> </ul>
<p><b>Domain of application</b> <i>(description of the range of conditions for which the model has been developed to apply)</i></p>	<p><b>Summary</b></p> <p>A version of CARBINE has been specifically developed for the UK GHG inventory. In principle, the M1 forest growth model that underlies CARBINE permits a very wide range of possible stand management regimes to be represented. However, when modelling UK forests at national scale, forest stand management are represented by four broad prescriptions types and a range of rotation length (see Annex 3 of the National Forestry Accounting Plan).</p> <p><b>References</b></p> <ul style="list-style-type: none"> <li>• Matthews et al. (in prep). The CARBINE model. A technical description. Chapter 2. Modelling purpose and scope</li> <li>• UK National Forestry Accounting Plan, 2021 to 2025 (2019) Annex 3. <a href="https://www.gov.uk/government/publications/uk-national-forestry-accounting-plan-2021-to-2025">https://www.gov.uk/government/publications/uk-national-forestry-accounting-plan-2021-to-2025</a></li> </ul>
<p><b>How the model parameters were estimated</b></p>	<p>Many of the parameters in CARBINE are based on literature reviews and the key parameters are described in the report describing CARBINE.</p> <p><b>References</b></p> <ul style="list-style-type: none"> <li>• Matthews et al. (in prep). The CARBINE model. A technical description. Chapter 2. Modelling purpose and scope.</li> <li>• Lavers, G.M. and Moore, G.L. (1983) The strength properties of timber. Building Research Establishment Report CI/SFB I(J3). Building Research Establishment, Garston</li> <li>• Levy, P.E., Hale, S.E. and Nicoll, B.C. (2004) Biomass expansion factors and root:shoot ratios for coniferous tree species in Great Britain. Forestry, 77, 421-430.</li> </ul>

Criteria (or element)	Reference to documentation
Description of key inputs and outputs	<p><b>Summary</b></p> <p><u>Inputs</u>: CARBINE uses a wide range of input data – see above for a description of these. The main input data are, inter alia, 1) information on the growth of stem wood volume in different stands of trees from the M1 growth model; 2) standard estimates for wood density (see Table 3.2 in Matthews et al.) and wood carbon content (0.5 t C odt<sup>-1</sup>); 3) management practices; 4) soil turnover rates; 5) decomposition rates of active soil pools to DOC, 6) occurrence of land use changes over time.</p> <p><u>Outputs</u>: All the data necessary for the reporting of forest land inventory: gains and losses in pools of carbon in standing trees, litter and soil in conifer and broadleaf forests and in harvested wood products and forest. Gains and losses in forest soils are also estimated.</p> <p>References</p> <ul style="list-style-type: none"> <li>• Matthews et al. (in prep). The CARBINE model. A technical description. Chapter 3. Representation of forest stands; to; Chapter 4. Representation of harvested wood products; and; Annex 1. Detailed soil carbon model description</li> </ul>
Details of calibration and model evaluation	<p><b>Summary</b></p> <p><b>CARBINE (excluding soil carbon)</b>: In 2003, Robertson <i>et al.</i> undertook a study to evaluate the completeness and suitability of the C-FLOW and CARBINE models for estimating carbon stocks and potential stock changes in the forestry sector at the stand and national levels, and the reliability of underpinning data and parameter estimates used by C-FLOW and CARBINE. Based on the results considered, Robertson et al. concluded that, while there may be some issues to address with regard to some inaccuracies in predictions of tree carbon stocks made by both CARBINE and C-FLOW, such model predictions are reasonably accurate. Although the analysis of Robertson et al. can only be regarded as an initial investigation, the results indicated that the accuracy of predictions made by both models is well within short-term fluctuations observed for individual stands (<math>\pm 10\%</math>).</p> <p>A more recent verification of the growth model M1 underpinning CARBINE started in 2017 has also confirmed that the growth model displayed good to reasonable consistency with growth trend data collected in sample plots. For some tree species, evidence of deviations in growth trends at older stand ages. This included Sitka spruce, but beyond the ages of conventional forest rotations. A programme to refine existing growth models is in progress. Significant work already done (new growth curves calibrated). The aspiration is to integrate the new growth models into CARBINE once fully tested. This is discussed in the report describing CARBINE.</p> <p><b>SCOTIA (soil sub-model in CARBINE)</b>: The work done to confirm the suitability of the soil carbon sub-model, SCOTIA, for use in the UK GHG inventory is explained in detail in a report in preparation. The work presents the evidence that the estimates of soil carbon stocks and stock changes produced by the SCOTIA model are consistent with available field observations.</p> <p><b>References</b></p> <ul style="list-style-type: none"> <li>• Matthews et al. (in prep). The CARBINE model. A technical description. Section 8.2.5. Long-term trajectories</li> <li>• Matthews et al. (in prep). SCOTIA forest soil carbon model: Interim progress report on comparison of model estimates and measurements of soil carbon stocks and fluxes</li> <li>• Robertson <i>et al.</i> (2003). Evaluation of the C-FLOW and CARBINE carbon accounting models. Section 3 of UK Emissions by Sources and Removals by Sinks due to Land Use, Land Use Change and Forestry Activities (2003) (<a href="https://www.semanticscholar.org/paper/Comparison-of-the-CFLOW-and-CARBINE-carbon-models-Robertson-Ford-Robertson/22f909599387970eef6b61ff7057151f4b86d76e">https://www.semanticscholar.org/paper/Comparison-of-the-CFLOW-and-CARBINE-carbon-models-Robertson-Ford-Robertson/22f909599387970eef6b61ff7057151f4b86d76e</a>)</li> </ul>

Criteria (or element)	Reference to documentation
<p><b>QA/QC procedures adopted (including verification and model intercomparison)</b></p>	<p><b>Summary</b></p> <p>The QA/QC procedures used in the forest land inventory are summarised in this NIR:</p> <ul style="list-style-type: none"> <li>• Section 6.2.6. Category-Specific QA/QC and Verification (CATEGORY 4A – FOREST LAND)</li> <li>• Section 6.8.4. Category-Specific QA/QC and Verification (CATEGORY 4G – HARVESTED WOOD PRODUCTS)</li> <li>• Section 6.11. GENERAL COMMENTS ON QA/QC.</li> </ul> <p>There is a detailed QA/QC plan for the forest land inventory, which is described in Henshall (2018). Chapter 8 of the CARBINE description report presents some comparisons of parameters referred to in the CARBINE model with standard estimates for these parameters from scientific literature, where relevant, and with any published parameter estimates of particular relevance to UK conditions. The SCOTIA report provides a detailed comparison of the CARBINE SCOTIA soil carbon sub-model estimates and measurements of soil carbon stocks and fluxes.</p> <p><b>References</b></p> <ul style="list-style-type: none"> <li>• Matthews et al. (in prep). The CARBINE model. A technical description. Chapter 8. Comparisons with standard parameters and estimates</li> <li>• Matthews et al. (in prep). SCOTIA forest soil carbon model: Interim progress report on comparison of model estimates and measurements of soil carbon stocks and fluxes</li> <li>• Henshall (2018). UK Greenhouse Gas Inventory LULUCF Sector Forest Land QA Plan. Paul Henshall. Forest Research</li> </ul>

Criteria (or element)	Reference to documentation
References to peer-reviewed literature	<p>There are several papers describing the C-FLOW model which follows the same theory of combining the FC yield tables with biomass expansion factors and a soil and litter model. There are also non-journal publications that have been reviewed by peers.</p> <p><b>Peer reviewed journal publications</b></p> <ul style="list-style-type: none"> <li>• Cannell, M.G.R., Dewar, R.C. (1995). The carbon sink provided by plantation forests and their products in Britain. <i>Forestry</i> 68, 35–48. doi: <a href="https://doi.org/10.1093/forestry/68.1.35">https://doi.org/10.1093/forestry/68.1.35</a></li> <li>• Dewar, R.C. (1990). A model of carbon storage in forests and forest products. <i>Tree Physiol.</i> 6, 417–28</li> <li>• Dewar, R.C. (1991). Analytical model of carbon storage in the trees, soils, and wood products of managed forests. <i>Tree Physiol.</i> 8, 239–258</li> <li>• Dewar, Roderick &amp; Cannell, M. (1992). Carbon sequestration in the trees, products and soils of forest plantations: An analysis using UK examples. <i>Tree physiology.</i> 11. 49-71. 10.1093/treephys/11.1.49.</li> </ul> <p><b>Non- journal publications</b></p> <ul style="list-style-type: none"> <li>• Matthews, R.W. (1996). The influence of carbon budget methodology on assessments of the impacts of forest management on the carbon balance, in: Apps, M.J., Price, D.T. (Eds.), <i>Forest Ecosystems, Forest Management and the Global Carbon Cycle</i>. Springer-Verlag, Berlin, New York, pp. 233–243.</li> <li>• Matthews, R.W. (1994). Towards a methodology for the evaluation of the carbon budget of forests. In: Kanninen, M. (Ed.), <i>Carbon Balance of the World's Forested Ecosystems: Towards a Global Assessment. Proceedings of a Workshop Held by the Intergovernmental Panel on Climate Change AFOS, Joensuu, Finland, 11-15 May 1992</i>. Painatuskeskus, Helsinki, pp. 105–114.</li> <li>• Matthews, R.W. (1992). Forests and arable energy crops in Britain: can they stop global warming? In: Richards, G.E. (Ed.), <i>Wood: Fuel for Thought</i>. Harwell, pp. 39-62.</li> <li>• Matthews, R.W. (1991). Biomass production and carbon storage by British forests. In: Aldhous, J.R. (Ed.), <i>Wood for Energy: The Implications for Harvesting, Utilisation and Marketing: Proceedings - 1991 Discussion Meeting</i>. Institute of Chartered Foresters, Edinburgh, pp. 162-177.</li> </ul>

### A 3.4.2.1 Forest activity data: management

The activity data for forests comes from different data sources for the public and private forest estates. The public forest estate is as defined in Forestry Statistics and covers the woodland that used to be managed by the Forestry Commission (FC) in Great Britain and that managed by the Northern Ireland Forest Service (NIFS). The public forest estate in Great Britain is now managed by separate organisations in England (Forestry England (FE)), Scotland (Forestry and Land Scotland (FLS)) and Wales (Natural Resources Wales (NRW)). The private forest estate covers all other woodland, including areas of forest managed by local authorities and other public bodies.

Each organisation maintains a Sub-Compartment DataBase (SCDB), containing information on location, size, species, growth rate and management of the forests. Information from the SCDB was used to create a distribution of species and yield class (an indication of growth rate) for the public forest estate. For the private forest estate, information from the National Forest Inventory (NFI) survey of woodlands was analysed to estimate yield class and species by age class and scaled to represent the whole private forest estate. Data from the Forestry Commission’s new planting and wood production statistics were used to assign the areas in an age class to individual years, either as areas restocked or areas newly planted.



Management of forests is represented as one of four options: Clearfell with thinnings, clearfell without thinnings, managed but not clearfelled, and not used for timber production. For the clearfell forests restocking occurs after the rotation period. For non-clearfell productive woodlands it is assumed there is a 30-year overlap of restocking and non-restocked trees. The area of land felled each year was estimated from the wood production statistics separately for both public and private forests. The rotation periods for forests were estimated based on information on the intended management of the public estate. This analysis gave a target rotation period for each modelled species and yield class.

The actual rotations historically applied to the forest estate are unknown and for the private forests the area of woodland used for timber production is also unknown. In order to match production, given the age class distribution of the forest, an algorithm was implemented to adjust the assumed rotations and the percentage of private sector woodland not used for timber production. This algorithm adjusts these assumptions in order to match the modelled wood production with the timber production statistics separately for the public and private forests. It was assumed that the forests would be felled evenly over a period +/-7 years from the target rotation period. A comprehensive description of this algorithm will be presented in a separate technical report.

Information on the management of privately owned forests that is used to inform the inventory estimates, as well as a description of how forest land AD (forest land remaining forest land; land converted to forest land) are derived, is included in the UK National Forest Accounting Plan, which can be found at:

<https://www.gov.uk/government/publications/uk-national-forestry-accounting-plan-2021-to-2025>

### **A 3.4.2.2 Forestry activity data: historical and current afforestation rates**

Irrespective of species assumptions, the variation in CO<sub>2</sub> removals from 1990 to the present is determined by the afforestation rate in earlier decades, the effect this has on the age structure in the present forest estate, and hence the average growth rate. Afforestation is assumed to occur on ground that has not been wooded for many decades, based on the assumption that if it had previously been woodland it would be in the restocking statistics rather than the new planting statistics as a result of the regulatory framework that applies to forestry in the UK.

A comparison of historical forest census data and the historical annual planting rates has been undertaken. Forest censuses were taken in 1924, 1947, 1965, 1980 and the late 1990s. The latest census (National Forest Inventory - NFI) has only just been completed. The comparison of data sources showed that discrepancies in annual planting rates and inferred planting/establishment date (from woodland age in the forest census) are due to restocking of older (pre-1920) woodland areas and variations in the harvesting rotations. However, there is also evidence of shortened conifer rotations in some decades and transfer of woodland between broadleaved categories (e.g. between coppice and high forest). It is difficult to incorporate non-standard management in older conifer forests and broadleaved forests into the Inventory because it is not known whether these forests are on their first rotation or subsequent rotations (which would affect carbon stock changes, particularly in soils). The area of afforestation in a given year is predicted based on applying the yearly distribution from the new planting and restocking statistics to the age class inventory. Age classes prior to the availability of new planting statistics are assigned evenly to individual years. For this inventory submission the assumption was made that we can estimate the area felled for recent years based on the timber production in the year of felling. It is assumed that woodland felled is immediately restocked. As we have an estimate of the area restocked for these years, the remainder of the area for each year was assumed to be restocking or natural

regeneration. For years prior to the timber production statistics (i.e. prior to 1976), an estimated ratio between restocking and afforestation was used based on the earliest data. For restocked woodland the forest area was assumed to have been restocked twice and had been managed in the same fashion and on the same rotation.

The planting data used as input to the CARBINE model come from national planting statistics from 1921 to the present (provided by the Forestry Commission) for England, Scotland and Wales and from 1900 to the present (provided by the Northern Ireland Forest Service). For England, Scotland and Wales estimates of area of woodland by species, yield class and broad age class came from analysis of the NFI (for private woodland) and the SCDB (for FC/NRW woodland).

The NFI provides woodland statistics for Great Britain, (England, Wales and Scotland), broken down by region. It comprises a digital woodland map based on comprehensive aerial photography and a field survey using 15,000 one-hectare sample squares. The digital map and field survey cover all woodland areas down to 0.5 hectares. An initial digital woodland map was published in spring 2011. The NFI woodland field survey provides direct assessments of woodland growing stock including species composition, stand structure, tree age (distribution) productivity indices, numbers of trees, and diameter and height distribution. Standing biomass (and carbon) in trees, including above and below ground biomass, can be derived from these assessments using GB-specific conversion factors and allometric equations. A complete 5-year cycle of ground survey has now been completed. NFI data do not allow the carbon stocks of deadwood or litter to be estimated. The NFI has been supplemented by an assessment of the area of small woods (woodland between 0.1 ha and 0.5 ha) to align with the minimum woodland area for UNFCCC reporting as set out in CMP.7 (Forestry Commission, 2017). The analysis of small woods area included no characterisation of the resource. Since there is currently no information on the age-distribution of the area of small woods, it was assumed to have established evenly between 1900 and 1970.

The NFI uses a lower integral open space threshold of 0.5 ha (as opposed to 1 ha), which requires a downward adjustment to areas. However, the main differences in 2010 GB woodland cover between the NFI (2982 kha) and previous estimates (2757 kha, Forestry Statistics 2010) arise from identified errors in the previous woodland survey, particularly the under-estimate of woodland areas between 0.5 and 2 hectares. Estimates of woodland loss have been assessed, which affect the total estimated woodland area in the GHGI (but are not yet reflected in the national Forestry Statistics).

We assumed that the NFI survey gives a distribution of all the private forest area for a base year of 2011, and the SCDB gives a distribution of all the public forest area for a base year of 2014.

The main NFI survey includes areas of woodland >0.5 ha. An adjustment was made to the areas of woodland to account for woods between 0.1 ha and 0.5 ha. For England and Wales, the estimates are derived from a calibration of tree cover plotted in the National Tree Map (NTM) product across England and Wales<sup>26</sup>, using a comparison of manual photographic interpretation with the NTM product within a sample of 1 km square tiles. For Scotland, the estimates are derived from a direct evaluation of polygons in the map constructed for the Native Woodlands of Scotland Survey (NWSS)<sup>27</sup>, which mapped all woodland polygons in Scotland down to 0.1 hectares in size

---

<sup>26</sup> <http://www.bluesky-world.com/national-tree-map>

<sup>27</sup> <http://scotland.forestry.gov.uk/supporting/strategy-policy-guidance/native-woodland-survey-of-scotland-nwss>

by photographic interpretation. The areas of small woods used in this inventory were based on data published in 2017 by the Forestry Commission in the report “Tree cover outside woodland in Great Britain”<sup>28</sup>.

An algorithm was used to obtain the area of woodland afforested each year by removing the area of felling from the age class distribution. The species were then allocated to this “residual distribution’ by starting in the base year and allocating the shortest rotations first. The planting years for all restocked woodland are assigned by the algorithm to give two rotations of the same length as the assigned rotation and are thus notional. This approach was undertaken to “spin up” the model in terms of soil and litter in order to reach a state consistent with land that has been forest for a long period. This algorithm will be described in detail in the same technical report as the description of allocation of the management of forests.

As part of implementation of wetland drainage and rewetting accounting, new maps of peat soils have been created for each of the DAs (see **Section A 3.4.7.1**). These maps were combined with a forest map to give areas of conifer and broadleaf forests planted on organic soils for each DA. These total areas were assigned to individual afforestation years by adjusting the previously applied the distribution of organic soil areas and an analysis of recent grant-aided new planting on organic soils and implementation of policies against planting on organic soils in each of the DAs.

As explained above, the planting rates given in **Table A 3.4.3** are derived from administrative records, information on forest age class distribution from NFI field assessments and interim assumptions about the age distribution of ‘small woods’. The planting rates given in **Table A 3.4.3** are therefore significantly different to those reported as official planting statistics supported by grant-aid. The afforestation rates for each planting type in the UK have been calculated from the data and are shown in **Table A 3.4.3**.

**Table A 3.4.3 Afforestation rate (kha p.a.) of conifers and broadleaves in the United Kingdom since 1500 based on estimates of woodland area by age from the NFI and administrative records.**

Period	Conifers on all soil types	Conifers on organic soil	Broadleaves on all soil types	Broadleaves on organic soils
1501-1600	0.00	0.00	0.02	0.00
1601-1700	0.09	0.00	0.47	0.00
1701-1750	0.28	0.00	1.05	0.00
1751-1800	0.64	0.00	0.88	0.00
1801-1850	2.03	0.00	0.74	0.00
1851-1900	5.14	0.65	1.12	0.02
1901-1910	4.44	0.89	9.27	0.19
1911-1920	3.13	0.60	11.72	0.26

<sup>28</sup> <https://www.forestresearch.gov.uk/tools-and-resources/national-forest-inventory/what-our-woodlands-and-tree-cover-outside-woodlands-are-like-today-8211-nfi-inventory-reports-and-woodland-map-reports/>

## Other Detailed Methodological Descriptions **A3**

Period	Conifers on all soil types	Conifers on organic soil	Broadleaves on all soil types	Broadleaves on organic soils
1921-1930	3.12	0.61	13.61	0.36
1931-1940	3.82	0.66	14.70	0.52
1941-1950	8.21	1.90	18.06	0.80
1951-1960	13.31	3.73	19.34	1.06
1961-1970	20.64	6.75	21.29	1.30
1971-1980	28.10	10.69	14.76	0.97
1981-1990	20.63	7.62	17.11	0.97
1991	14.79	5.04	12.62	0.66
1992	12.71	4.22	14.67	0.77
1993	10.28	3.32	18.27	0.92
1994	14.04	4.47	19.74	1.04
1995	12.70	3.91	16.59	0.82
1996	12.49	3.70	16.06	0.79
1997	12.17	3.42	17.93	0.76
1998	11.61	3.12	17.75	0.75
1999	11.70	2.99	17.83	0.75
2000	10.29	2.49	19.75	0.87
2001	7.21	1.66	15.88	0.75
2002	6.96	1.51	15.59	0.64
2003	6.73	1.49	13.93	0.56
2004	3.30	0.77	13.29	0.46
2005	2.41	0.58	12.07	0.39
2006	3.02	0.65	12.82	0.41
2007	2.30	0.50	10.24	0.33
2008	2.13	0.40	8.25	0.23
2009	1.54	0.28	7.52	0.18
2010	2.70	0.37	9.89	0.21
2011	4.50	0.32	13.17	0.14
2012	2.37	0.08	14.52	0.06
2013	2.42	0.00	12.64	0.00
2014	2.79	0.00	8.86	0.00
2015	2.39	0.00	4.66	0.00

Period	Conifers on all soil types	Conifers on organic soil	Broadleaves on all soil types	Broadleaves on organic soils
2016	3.42	0.00	3.11	0.00
2017	4.96	0.00	3.64	0.00
2018	7.58	0.00	5.00	0.00
2019	7.86	0.00	5.78	0.00
2020	7.40	0.00	5.99	0.00
2021	6.98	0.00	6.73	0.00

### A 3.4.2.3 Allocation of CARBINE outputs to UNFCCC inventory sub-categories

The CARBINE model output was post-processed using the IPCC default 20-year transition period for Land converted to Forest to move into the Forest remaining Forest category. The area within the Land converted to Forest Land sub-category is split between cropland, pasture grassland, semi-natural grassland, settlement and other areas. Pasture grassland and semi-natural grassland are combined for Grassland reporting in the CRF. This split is based on the relative proportions of historical land use change from these categories to forest. The proportions for each country change over time because the 20-year transition period has a different start date for each reporting year. The CARBINE model outputs take account of forest area loss through conversion to other land uses (deforestation).

### A 3.4.2.4 Nitrogen fertilization of forest land

Nitrogen fertilization of forest land is assumed to occur only when absolutely necessary, i.e. new planting on ‘poor’ soils (mining spoil, impoverished brown field sites, or upland organic soils). In terms of the inventory, this means that N fertilisation is assumed for Settlement converted to Forest land and Grassland converted to Forest Land on organic soils. The areas of new planting with these conditions were taken from the same dataset used in the CARBINE model (see **Table A 3.4.3**) for 4.A.2. Land converted to Forest land.

Where fertilisation occurs, an application rate of 150 kg N ha<sup>-1</sup> is assumed based on Forestry Commission fertilisation guidelines (Taylor, 1991). The guidelines recommend applying fertiliser on a three-year cycle until canopy closure (at approximately 10 years), but this is thought to be rather high (Skiba 2007) and unlikely to occur in reality, so two applications are adopted as a compromise. These applications occur in year 1 and year 4 after planting. The N<sub>2</sub>O emission factor for applied nitrogen fertiliser is the default value of 1% used in the IPCC 2006 Guidelines. Emissions of N<sub>2</sub>O from N fertilisation of forests are estimated using a Tier 1 methodology and IPCC default emission factors. The emissions have fallen since 1990 due to reduced rates of new forest planting. A GWP of 298 for N<sub>2</sub>O is used. Indirect emissions of N<sub>2</sub>O from atmospheric deposition also arise from this activity and are reported under Sector 4.

### A 3.4.2.5 Non-CO<sub>2</sub> emissions from drainage on forest soils

Emissions from forest on drained soils are calculated for mineral and organic soils separately using a Tier 1 methodology. Emissions of CH<sub>4</sub> and N<sub>2</sub>O from organic soils are calculated using Tier 1 EFs (see **Section A 3.4.7**). Emissions of N<sub>2</sub>O from mineral soils are calculated using Tier 1 EFs (IPCC 2006) and information on the distribution of forest cover on different soil types (Yamulki *et al.* 2012), adjusted by the amount of forest planted since 1920. The area of forest on mineral soil is adjusted by splitting it between organo-mineral soils, free-draining mineral soils and

easily waterlogged mineral soils, which require artificial drainage (based on the current guidance and policy for forest operations and management). The proportion of mineral soils requiring artificial drainage is: 34% in England, 24% in Scotland, 3% in Wales, 68% in Northern Ireland and 26% in the UK as a whole. We assumed all forest on organo-mineral soils is cultivated prior to planting and therefore effectively drained.

### **A 3.4.3 Land Use Change and Soils (4B, 4C, 4E)**

#### **A 3.4.3.1 Estimation of land-use change using Bayesian data assimilation**

The tracking of land use and land-use change is fundamental to producing accurate and consistent greenhouse gas inventories for the LULUCF sector. In previous inventories the methodology for land use/land-use change modelling applied Approach 2 (non-spatial LUC matrices) using a combination of 'snapshot' Countryside Surveys, forest inventory and administrative statistics. However, this approach has proved to be insufficient for tracking annual land use change, which was particularly a consideration for the reporting requirements of the second commitment period of the Kyoto protocol. Firstly, the non-spatial matrix-based approach is insufficient for tracking annual land-use change: the matrices have no time dimension and are defined independently each year. There is therefore no possibility of representing a sequence of land-use on the same parcel of land (such as afforestation followed by deforestation, or crop-pasture rotations). Secondly, the data used to estimate these matrices in the UK are rather limited. The Countryside Surveys are only carried out approximately once per decade (and not since 2007), and whilst the geographical extent is very wide, the actual ground area surveyed is a small fraction of the total UK area. The afforestation/deforestation statistics from the Forestry Commission have good national coverage (excluding Northern Ireland) but do not contain any information on the spatial location or land use prior to afforestation or following deforestation.

BEIS (now DESNZ) commissioned a research project (Land-Use Tracking) to improve tracking of land use change for the LULUCF sector (reference TRN 2384/05/2020), with additional funding for inventory implementation. This built on the successful pilot project that used a Bayesian data assimilation approach to integrate available multiple land-use data sources into vectors, i.e., unique sequences of land use histories and their associated areas (Levy *et al.* 2018). In the pilot study, carbon emissions arising from land-use change were modelled using the vector output, demonstrating the feasibility of using this as a methodology for the LULUCF sector.

Although the UK is well-provided with land-use datasets, UK land-use change occurs on small, fragmented areas and there is no single time-series with sufficient reliability to infer annual land-use change by difference for inventory reporting. Even with advances in satellite sensors, GIS and spatial data handling, the accuracy of change detection from EO-based products is generally too poor; the different EO products are inconsistent (with each other, and with themselves over time), irregular, and infrequent before 2000. Repeat ground-based surveys can detect change more reliably but lack a spatial element or information on gross change (e.g., the annual June Agricultural Census) and survey coverage is often incomplete or at infrequent intervals.

In the 1990-2020 submission the UK updated the methodology for estimating land use change using a Bayesian data assimilation approach. This constrains estimates of gross land-use change with national-scale census data, whilst retaining the detailed information available from other land-use data sources. A full description of the methodology is given in the project reports (Levy *et al.* 2020, 2021; Rowland *et al.* 2021) and a summary is given here. Development work on the matrices and the methodology is ongoing.

### A 3.4.3.1.1 *Land-use change data sets*

A range of datasets containing relevant information on land use and land-use change in the UK were assessed for inclusion in the Bayesian assimilation approach:

- Countryside Survey (DAERA 2016, UKCEH 2020a): GB and NI field repeated surveys of stratified 1km sample grid squares giving land-use and land-use change;
- Agricultural census data (DAERA 2021, Defra 2021, Scottish Government 2021, Welsh Government 2021): annual records of the total area in the main agricultural land uses;
- Land Cover Map (UKCEH 2020b): thematic land-cover classification of satellite image data covering the UK;
- Land Cover® plus: Crops (UKCEH 2016): Based on the LCM parcel framework with additional crop information from satellite data
- CORINE Land Cover (CORINE 2020): Survey of European land cover and land cover change from semi-automatic interpretation of high resolution satellite imagery;
- Agricultural holdings data: this is the finest level of detail from the Agricultural census dataset with information on agricultural land areas at the farm level;
- IACS: field-level register of agricultural subsidy claims under the EU Common Agricultural Policy;
- CROME: crop classification of satellite imagery for England, with ground-truth data from agricultural subsidy inspectors;
- Forestry Commission and Forest Service Northern Ireland data: forestry statistics on afforestation and deforestation currently used in the GHGI, forest maps from National Forest Inventory and National Forest Estate Sub-Compartment Database (Forestry Commission 2020);
- FAOStat MODIS data on artificial surfaces: annual area of coverage of artificial surfaces (urban) in the UK 2001-2018 from satellite imagery <https://www.fao.org/faostat/en/#data/LC> .

The decadal LUC matrices compiled for 1950-1979 from the Monitoring Landscape Change (MLC) dataset for Great Britain (MLC 1986) were also used. The only data available for Northern Ireland pre-1990 are land use areas from The Agricultural Census and The Forest Service (Cruickshank and Tomlinson 2000).

Some datasets were obtained under licence from the different national governments (IACS, agricultural holdings data) as they contain sensitive information. It was not possible to obtain permission for some data within the timescales of the research project (agricultural holdings for England, Wales and Northern Ireland, and IACS data for Scotland, Wales and Northern Ireland) but efforts are continuing to obtain, assess and integrate these datasets in the future.

## Other Detailed Methodological Descriptions **A3**

**Table A 3.4.4 Mapping land-use data categories to LULUCF categories (GB: Great Britain, E: England, S: Scotland, W: Wales, NI: Northern Ireland, UK: United Kingdom of Great Britain and Northern Ireland)**

Data source	Spatial and temporal coverage	Forest Land	Cropland	Grassland-pasture	Grassland-rough	Settlement	Other	Not included
Countryside Survey	GB 1984, 1990, 1998/99, 2007 NI: ~1990, 1998, 2007	Broadleaved and Mixed; Coniferous woodland	Arable and Horticulture	Improved Grassland	Neutral Grassland; Calcareous grassland; Acid grassland; Fen Marsh and Swamp; Dwarf Shrub heath; Bog; Littoral Sediment	Built Up Areas and Gardens	Inland Rock; Supra-littoral Rock; Supra-littoral sediment; Littoral Rock	Saltwater Freshwater
Agricultural Census	E,S,W,NI: 1951-present	Woodland	Crops; Uncropped arable land	Temporary grass sown in past 5 years; Land used for outdoor pigs; Grass over 5 years old	Common rough grazing; Sole right rough grazing			
Land Cover Map	UK: 1990, 2015, 2017, 2018, 2019,2020 (publicly available), UK: 1994, 1998, 2002, 2006, 2010 created for the BEIS Land-use Tracking project	Broadleaved Woodland; Coniferous Woodland	Arable and Horticulture	Improved Grassland	Neutral Grassland; Calcareous grassland; Acid grassland; Fen Marsh and Swamp; Heather; Heather grassland; Bog; Saltmarsh	Urban; Suburban	Inland rock; Supra-littoral Rock; Supra-littoral sediment; Littoral Rock	Saltwater Freshwater
Land Cover plus Crops	GB: 2015 (partial coverage), 2016, 2017, 2018, 2019		Beet, Field Beans, Maize, oilseed Rape, other crop, Peas, Potatoes,	Grass				



## Other Detailed Methodological Descriptions **A3**

Data source	Spatial and temporal coverage	Forest Land	Cropland	Grassland-pasture	Grassland-rough	Settlement	Other	Not included
			Spring barley, Spring Wheat, Winter barley, Winter oats, Winter wheat					
CORINE land Cover	UK: 2000, 2006, 2012, 2018	Agro-forestry areas; Broadleaved woods; Coniferous woods; Mixed woods	Non-irrigated arable land; Permanently irrigated land; Rice fields; Vineyards; Fruit trees and berry plantations; Olive groves; Annual crops ; associated with permanent crops; Complex cultivation patterns	Green urban areas; Sport and leisure facilities; Pastures	Natural grasslands; Moors and heathland; Sclerophyllous vegetation; Transitional woodland-shrub; Inland marshes; Peat bogs; Salt marshes	Continuous urban fabric; Discontinuous urban fabric; Industrial or commercial units; Road and rail network and associated land; Port areas; Airports; Mineral extraction sites; Dump sites; Construction sites	Beaches dunes sands; Bare rocks; Sparsely vegetated areas; Burnt areas; Glaciers and perpetual snow; Salines	Intertidal flats; Water courses; Water bodies; Coastal lagoons; Estuaries; Seas and ocean; NODATA
Monitoring Landscape Change	GB: 1947, 1969, 1980	Broadleaved wood; Conifer wood; Mixed wood	Crops; Market garden; Orchards	Improved grassland	Upland heath; Upland smooth grassland; Upland coarse grass; Blanket bog; Bracken Lowland rough grass; Lowland heather; Gorse; Neglected grassland; Marsh; Rough pasture; Peat bog; Fresh Marsh; Salt marsh	Built up; Urban open, Transport; Mineral workings; Derelict	Bare rock; Sand/shingle; Inland water; Coastal water	

The agricultural holdings data for Scotland were supplied for 1990-2018 and provide spatial data at the postcode or parish level, rather than the exact location. IACS data use a very large number of classes, which have changed over time, and a table showing the correspondence between these and LULUCF classes is too large to display here but available on request. The IACS data require considerable processing and classification to ensure consistency and only the data for England 2004-2014 were included in the data assimilation, as issues with 2015-2019 data had not been resolved within the timescale of the Land-Use Tracking project.

Ordnance Survey Land Use Change Statistics and LUCAS (Land Use Cover Area Frame Survey) were also assessed but not included in the final data assimilation because of time constraints on data processing and analysis.

The datasets covering multiple land categories were mapped to the LULUCF categories (**Table A 3.4.4**), with a sub-division of grassland between improved pasture and semi-natural rough grazing land. Land-use change information from repeated survey data and decadal land-use change matrices were transformed to annual time series based on interpolation between the survey/decadal start dates.

#### *A 3.4.3.1.2 Bayesian data assimilation methodology*

There are three data structures that provide information on land-use change:

- the time series of areas of each land use, **A**
- the transition matrix **B** denoting the areas which have changed from each land use to each of the other land uses, over a given time period
- the 3-D spatio-temporal array **U** which denotes land use at each location in space and time, in a regular gridded format.

The three data structures are inter-related by arithmetic equations (see Levy *et al.* 2018). These equations are used as a model to relate the different observational data via Bayesian data assimilation in a two-stage process.

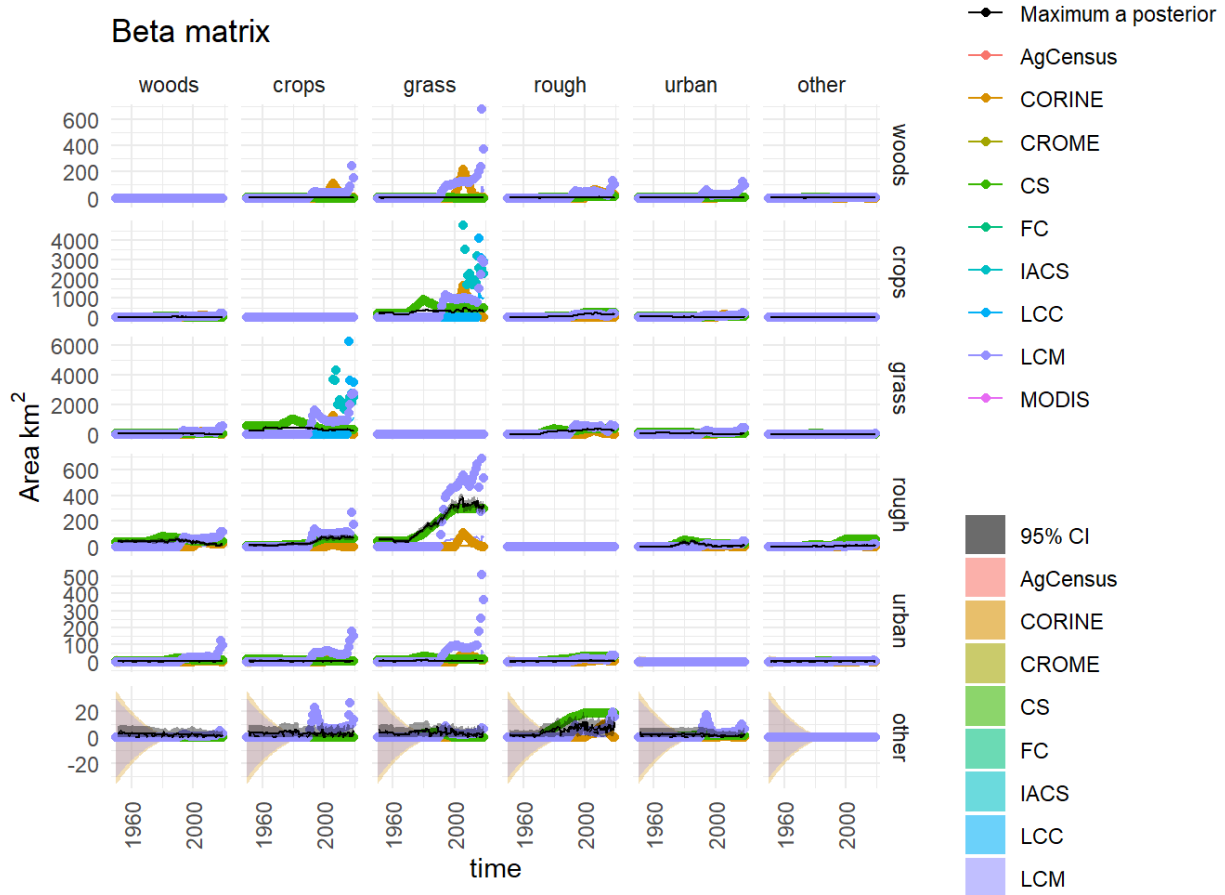
- Firstly, a Bayesian approach is used to estimate the parameters in **B**, given prior information and partial observations of **U** and **A**.
- Secondly, the posterior distribution of **B** and spatial and probabilistic information on the location of land-use change (**W**) is used to simulate posterior realisations of **U**.

The maximum a posteriori probability (MAP, the mode of the posterior distribution) realisations represent the best estimate of land-use and land-use change, given the available data. The spread of possible realisations in the posterior distribution provides the uncertainty in our knowledge of the true land-use change.

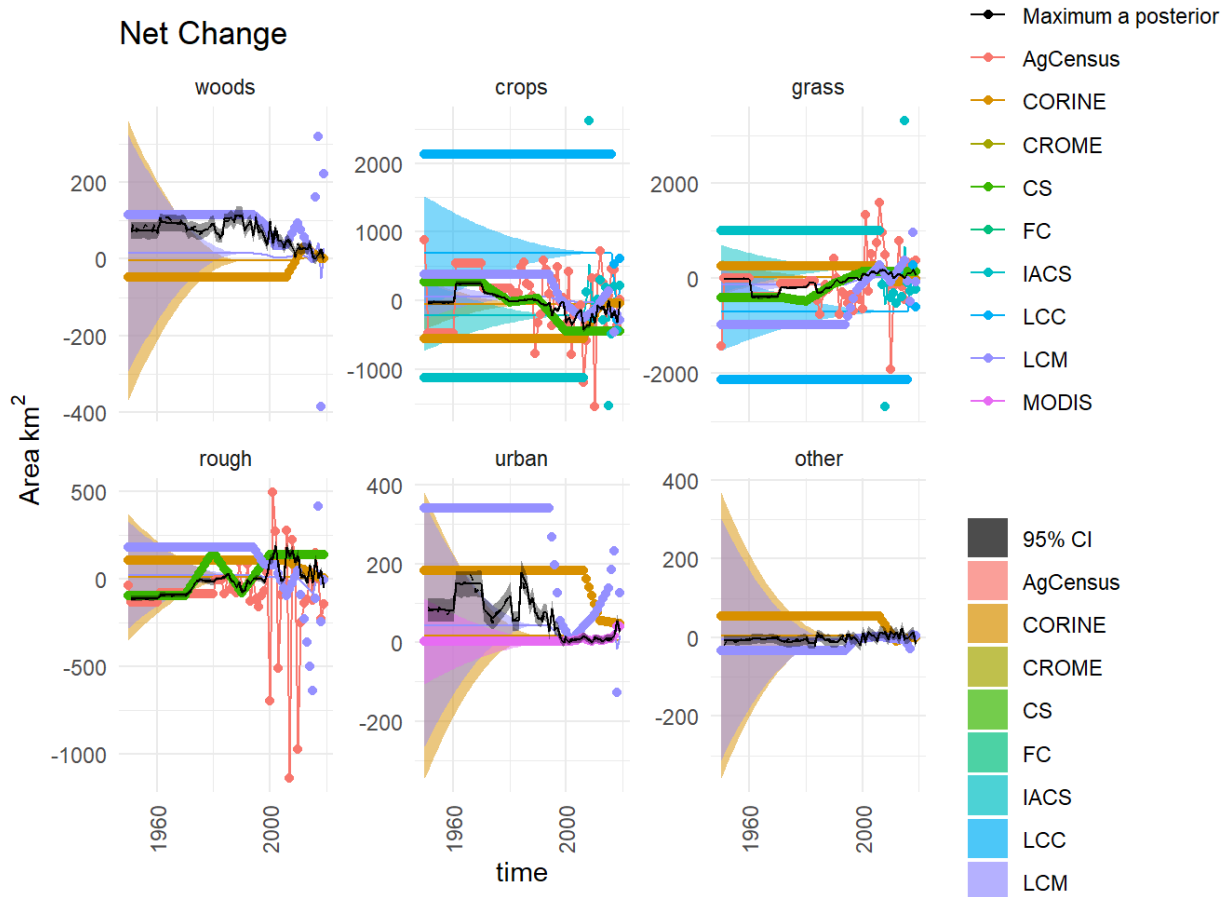
The output data structure **U** has the high temporal and spatial resolution (annual and 100 m) necessary for capturing small-scale land-use. The data cuboid **U** contains a lot of repetition and can be summarised efficiently as the set of unique vectors of land use over time, together with their associated areas. This provides an intermediate option for modelling the effects of land-use change in the GHG inventory, without requiring a fully spatially explicit model.

The data assimilation approach produced transition matrix (the gross area changing annually between the different land uses from 1951-2020), the gross gain in area of each land use, the gross loss of area for each land use, and the net change in area occupied by each land use, for each devolved administration (sections 7-10 in Levy *et al.* 2021). Example outputs are shown in **Figure A 3.10** and **Figure A 3.11**.

**Figure A 3.10** Transition matrix for England, representing the gross area change between land uses 1951-2020, showing the observations and posterior distribution of estimates. The grey shaded band is the 2.5-97.5 percentiles of the posterior distribution, with the MAP the black line within this. (Levy *et al.* 2021).



**Figure A 3.11** Time series of the net change in the area of each land use 1950-2020, showing the observations and posterior distribution of estimates. The grey shaded band is the 2.5-97.5 percentiles of the posterior distribution, with the MAP the black line within this. (Levy et al. 2021). The thin coloured lines are the corrected observations, after accounting for systematic uncertainty, and interpolating.



### A 3.4.3.1.3 *Uncertainty associated with the different datasets in the Bayesian assimilation*

There was a detailed quantification of uncertainty for data included in the assimilation (Levy *et al.* 2021). For every spatial data source, the following contribution to uncertainty were assessed:

- False positive rate,  $F_p$  (over-estimation of land-use change that did not happen)
- False negative rate,  $F_N$  (under-estimation through missing true land-use change)
- Random uncertainty  $\sigma$ 
  - Data-source specific

$$\sigma^{\text{obs}}$$

- Sampling frequency (increasing uncertainty as the sampling frequency increases from annual to decadal intervals)

$$\sigma_{\text{ann}}^{\text{obs}} = \sigma^{\text{obs}} \sqrt{n}$$

- Sampling coverage (higher uncertainty outside the bounds of the data coverage).

$$\sigma_t^{\text{obs}} = \sigma^{\text{obs}} \Delta_t^2$$

These contributions were included when estimating the likelihood of every land-use transition. For every observation, likelihood was estimated:

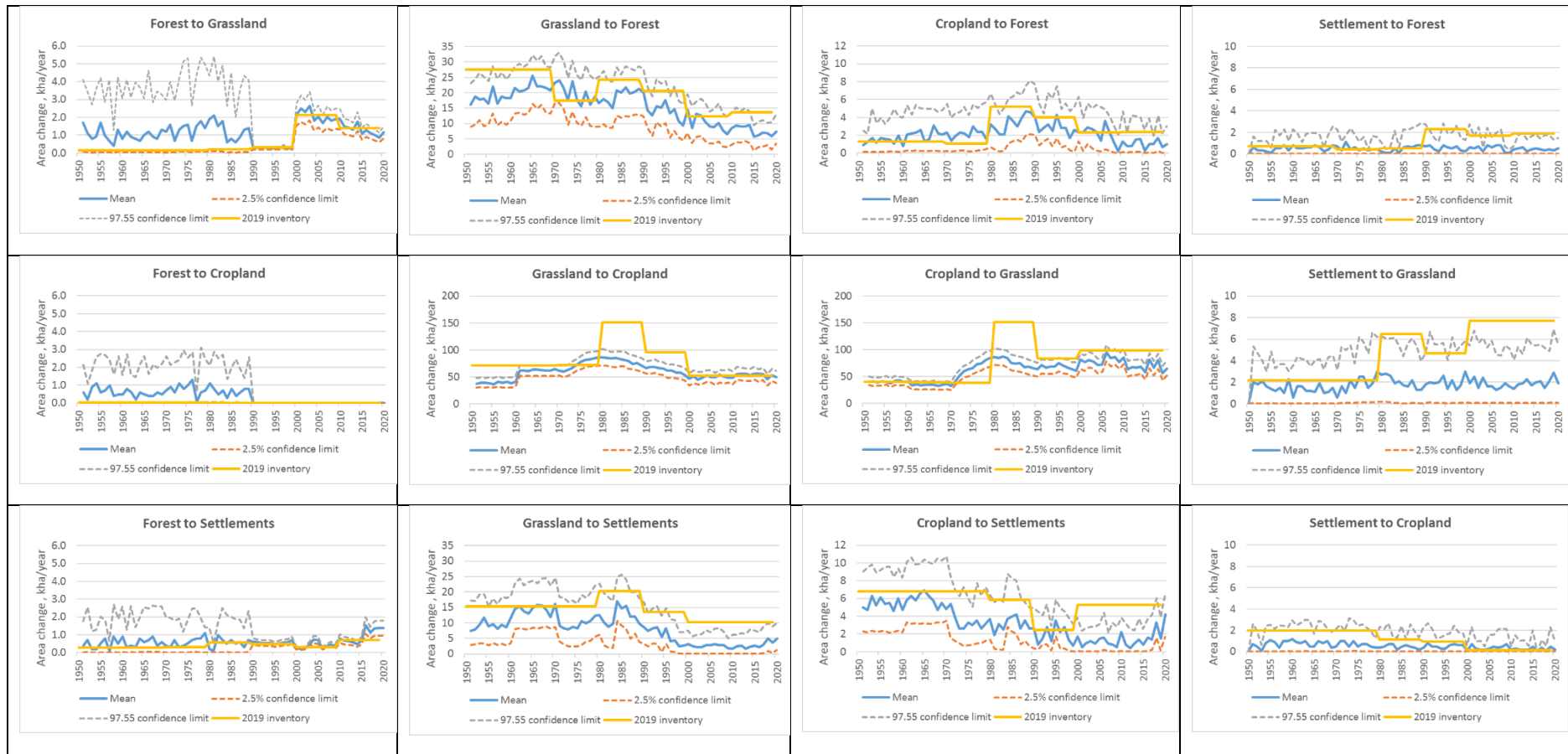
$$\mathcal{L} = \frac{1}{\sigma_{ij}^{\text{obs}} \sqrt{2\pi}} \exp\left(-\left((1 - F_P)\beta_{ij}^{\text{obs}} + A_N F_N - \beta_{ij}^{\text{pred}}\right)^2 / 2\sigma_{ij}^{\text{obs}2}\right)$$

Most spatial datasets had high false positives and random uncertainty, which were large in relation to the small signal of true land-use change in the UK. These uncertainties were corrected for in the data assimilation algorithm by correcting for false positives and down-weighting the more uncertain datasets. A preliminary assessment with only a subset of datasets to constrain the land-use change matrix produced fairly similar results.

### A 3.4.3.1.4 *Land-use change results*

The rates of land-use change 1951-2020 estimated by the data assimilation are shown in **Figure A 3.12**, superimposed with the rates of land-use change used in the 1990-2019 inventory. The annual rates of land-use change in 2020 have also been used for 2021, pending further refinement of the methodology. As in previous years, the land-use change activity data uses Approach 2, but with annual input data instead of decadal. Pending further analysis, it has been assumed that gross changes to/from the 4F Other Land category correspond to noise, especially from the EO-derived datasets, and these transitions are not considered (as has been done previously). The UK continues to use the rates of afforestation (whole time series) and deforestation (1990 onwards) from national forest statistics. However, additional information on the proportions of afforestation on cropland, grassland and settlements and information on pre-1990 deforestation from the Land-Use Tracking project is used in the transitions.

# Other Detailed Methodological Descriptions **A3**



**Figure A 3.12** Time series for UK land-use transitions 1951-2020, showing the mean, 95% confidence limits and the 1990-2019 inventory LUC time series, based on Countryside Survey and historic datasets.

Land use change on organic soils uses the information from Evans et al. (2017) (see **Section A 3.4.7**), but further analysis of land-use vectors on organic soils will be undertaken in the second stage of implementation of the Land-Use Tracking project.

Work was also done to improve the accuracy of representation of crop-grass rotational management, using the idea of “life tables” or age-specific transition probabilities, from population modelling. The life table probabilities are based on an analysis of the available data from IACS, CROME, LCM, and LCC, and these all show consistent patterns. Of these, IACS has much the longest time span of data, and is the dominant source of information. Using this method, the observed frequencies of transitions from crop to grassland as a function of cropland age (and vice versa for grassland) are now reproduced in the land-use vectors, and thereby approximate the observed frequency of crop-grass rotations. Implementing this in the inventory requires re-writing the soils model to use land-use vector data rather than land-use matrices. Work is being done on this, with rigorous QA/QC, with the intention of implementing in later submissions.

The full set of annual land use change matrices 1990-latest inventory year for the GBE, GBK and GBR submissions are provided in in Chapter 6 of the main NIR report, **Section 6.1.1**. The full set of annual matrices is used in the calculation of non-forest biomass carbon stock change. The full set is adjusted to take account of land use change on organic soils (see **Section A 3.4.7**) to produce a set of matrices for changes on non-organic soil only (which includes both mineral and organo-mineral soils) and these are used as input for the soils model described below.

### **A 3.4.3.2 Soils modelling**

A database of soil carbon density for all soils in the UK (Milne & Brown 1997, Cruickshank *et al.* 1998, Bradley *et al.* 2005) is used in conjunction with the land use change matrices. There are three soil surveys covering England and Wales, Scotland and Northern Ireland. The field data, soil classifications and laboratory methods for these surveys have been harmonized to reduce uncertainty in the final joint database. The depth of soil considered was also restricted to 1 m at maximum as part of this process. The dynamic model of carbon stock change requires the change in equilibrium carbon density from the initial to the final land use. The core equation describing changes in soil carbon with time for any land use transition is:

$$C_t = C_f - (C_f - C_o)e^{-kt}$$

Where:  $C_t$  is carbon density at time  $t$ ,  $C_o$  is the assumed equilibrium carbon density initial land use,  $C_f$  is the assumed equilibrium carbon density after change to new land use and  $k$  is time constant of change.

Differentiating this equation gives the flux  $f_t$  (emission or removal) per unit area:

$$f_t = k(C_f - C_o)e^{-kt}$$

This equation gives, for any inventory year, the land use change effects from any specific year in the past. If  $A_T$  is area in a particular land use transition in year  $T$  considered from 1950 onwards then total carbon lost or gained in an inventory year, e.g. 1990, is given by:

$$F_{1990} = \sum_{T=1950}^{t=1990} kA_T(C_f - C_o)(e^{-k(1990-T)})$$

This equation is used with  $k$ ,  $A_T$  and  $(C_T - C_0)$  chosen by Monte Carlo methods within ranges set by prior knowledge, e.g. literature, soil carbon database, agricultural census, LUC matrices.

The model calculates the change in equilibrium carbon density from the initial to the final land-use for each land-use category as averages for Scotland, England, Wales and Northern Ireland. These are weighted by the area of land-use change occurring in each soil group to account for the actual carbon density where change has occurred. In previous inventories four broad soil groups were used (organic, organo-mineral, mineral, unclassified). With the implementation for the first time of methodologies consistent with chapters 2 and 3 of the 2013 IPCC Wetlands supplement, we now have areas of land use change on organic soils and the emission factors for the associated carbon losses. This would lead to double-counting without the adjustment of the soil carbon model to exclude land use change on organic soils. The equilibrium soil carbon density and weighting is now based on the non-organic soil groups only.

Mean soil carbon density change is calculated as:

$$\bar{C}_{ijc} = \frac{\sum_{s=1}^6 (C_{sijc} L_{sijc})}{\sum_{s=1}^6 L_{sijc}}$$

This is the weighted mean, for each country, of change in equilibrium soil carbon when land use changes, where:  $i$  = initial land use (Forestland, Grassland, Cropland, Settlements),  $j$  = new land use (Forestland, Grassland, Cropland, Settlements),  $c$  = country (Scotland, England, N. Ireland & Wales),  $s$  = soil group (organo-mineral, mineral, unclassified) and  $C_{sijc}$  is change in equilibrium soil carbon for a specific land use transition

The land use data (1990 to 1998) is used in the weighting. The average change and range calculated are presented in **Table A 3.4.5-Table A 3.4.8**.

**Table A 3.4.5 Weighted average change and range ( $\pm\%$  from mean value) in equilibrium non-organic soil carbon density ( $t\ ha^{-1}$ ) to 1 m deep for changes between different land types in England**

From To	Forestland	Grassland	Cropland	Settlements
Forestland	0	5 ( $\pm 44\%$ )	30 ( $\pm 7\%$ )	79 ( $\pm 4\%$ )
Grassland	-5 ( $\pm 49\%$ )	0	24 ( $\pm 0\%$ )	75 ( $\pm 4\%$ )
Cropland	-30 ( $\pm 7\%$ )	-24 ( $\pm 2\%$ )	0	49 ( $\pm 3\%$ )
Settlements	-79 ( $\pm 4\%$ )	-73 ( $\pm 3\%$ )	-50 ( $\pm 2\%$ )	0



**Table A 3.4.6 Weighted average change and range ( $\pm\%$  from mean value) in equilibrium non-organic soil carbon density ( $t\ ha^{-1}$ ) to 1 m deep for changes between different land types in Scotland**

From To	Forestland	Grassland	Cropland	Settlements
Forestland	0	56 ( $\pm 4\%$ )	174 ( $\pm 2\%$ )	235 ( $\pm 2\%$ )
Grassland	-61 ( $\pm 4\%$ )	0	101 ( $\pm 0\%$ )	171 ( $\pm 0\%$ )
Cropland	-180 ( $\pm 1\%$ )	-101 ( $\pm 0\%$ )	0	62 ( $\pm 4\%$ )
Settlements	-242 ( $\pm 0\%$ )	-168 ( $\pm 1\%$ )	-54 ( $\pm 14\%$ )	0

**Table A 3.4.7 Weighted average change and range ( $\pm\%$  from mean value) in equilibrium non-organic soil carbon density ( $t\ ha^{-1}$ ) to 1 m deep for changes between different land types in Wales**

From To	Forestland	Grassland	Cropland	Settlements
Forestland	0	14 ( $\pm 54\%$ )	51 ( $\pm 13\%$ )	105 ( $\pm 12\%$ )
Grassland	-13 ( $\pm 65\%$ )	0	38 ( $\pm 11\%$ )	91 ( $\pm 10\%$ )
Cropland	-48 ( $\pm 21\%$ )	-39 ( $\pm 2\%$ )	0	46 ( $\pm 10\%$ )
Settlements	-104 ( $\pm 12\%$ )	-89 ( $\pm 6\%$ )	-55 ( $\pm 6\%$ )	0

**Table A 3.4.8 Weighted average change and range ( $\pm\%$  from mean value) in equilibrium non-organic soil carbon density ( $t\ ha^{-1}$ ) to 1 m deep for changes between different land types in Northern Ireland**

From To	Forestland	Grassland	Cropland	Settlements
Forestland	0	39 ( $\pm 10\%$ )	106 ( $\pm 10\%$ )	192 ( $\pm 10\%$ )
Grassland	-39 ( $\pm 10\%$ )	0	68 ( $\pm 10\%$ )	153 ( $\pm 10\%$ )
Cropland	-106 ( $\pm 10\%$ )	-68 ( $\pm 10\%$ )	0	85 ( $\pm 10\%$ )
Settlements	-192 ( $\pm 10\%$ )	-153 ( $\pm 10\%$ )	-85 ( $\pm 10\%$ )	0

The rate of loss or gain of carbon is dependent on the type of land use transition (**Table A 3.4.9**). For transitions where carbon is lost e.g., transition from Grassland to Cropland, a ‘fast’ rate is applied, whilst a transition that gains carbon occurs much more slowly. A literature search for information on measured rates of changes of soil carbon due to land use was carried out and ranges of possible times for completion of different transitions were selected, in combination with

modelling and expert judgement (Milne and Brown, 1999; Ashman, *et al*, 2000, Salway *et al*, 2001). These are shown in **Table A 3.4.10**. The Scottish carbon gains are slower because Scottish soils generally have a higher equilibrium carbon content.

**Table A 3.4.9 Rates of change of soil carbon for land use change transitions**

From To	Forestland	Grassland	Cropland	Settlement
Forestland		<i>Slow</i>	<i>slow</i>	<i>slow</i>
Grassland	<i>Fast</i>		<i>slow</i>	<i>slow</i>
Cropland	<i>Fast</i>	<i>Fast</i>		<i>slow</i>
Settlement	<i>Fast</i>	<i>Fast</i>	<i>fast</i>	

("Fast" & "Slow" refer to 99% of change occurring in times shown in **Table A 3.4.10**)

**Table A 3.4.10 Range of times for soil carbon to reach 99% of a new value after a change in land use in England (E), Scotland (S), Wales (W) and Northern Ireland (NI)**

	Low (years)	High (years)	Years to reach 50% of carbon stock change (mean)	Years to reach 90% of carbon stock change (mean)
Carbon loss ("fast") E, S, W, NI	50	150	15	52
Carbon gain ("slow") E, W, NI	100	300	29	97
Carbon gain ("slow") S	300	750	74	247

A Monte Carlo approach is used to vary the rate of change, the area activity data and the values for soil carbon equilibrium (under initial and final land use) for all countries in the UK. The model of change was run 1000 times using parameters selected from within the ranges described above. The mean carbon flux for each region resulting from this imposed random variation is reported as the estimate for the Inventory. An adjustment was made to these calculations for each country to remove increases in soil carbon due to afforestation, as the CARBINE model provides a better estimate of these fluxes in the Land Converted to Forest Land category. Variations from year to year in the reported net emissions reflect the trend in land use change as described by the land-use change time series.

#### A 3.4.3.2.1 *Change in soil carbon stock due to cropland management activities*

Change in soil carbon stocks due to cropland management activities is estimated using the methodology developed in Defra project SP1113 (Moxley *et al*, 2014a) which reviewed UK relevant literature on the effects of cropland management practices on soil carbon stocks and attempted to model UK specific emission factors.

Increases in inputs of fertiliser, manure and crop residues were found to increase soil carbon stocks of tillage land, but changes in the tillage regime from conventional tillage to reduced or zero tillage were found to have no significant effect in a UK context. This activity is only relevant for non-organic soils in the UK.

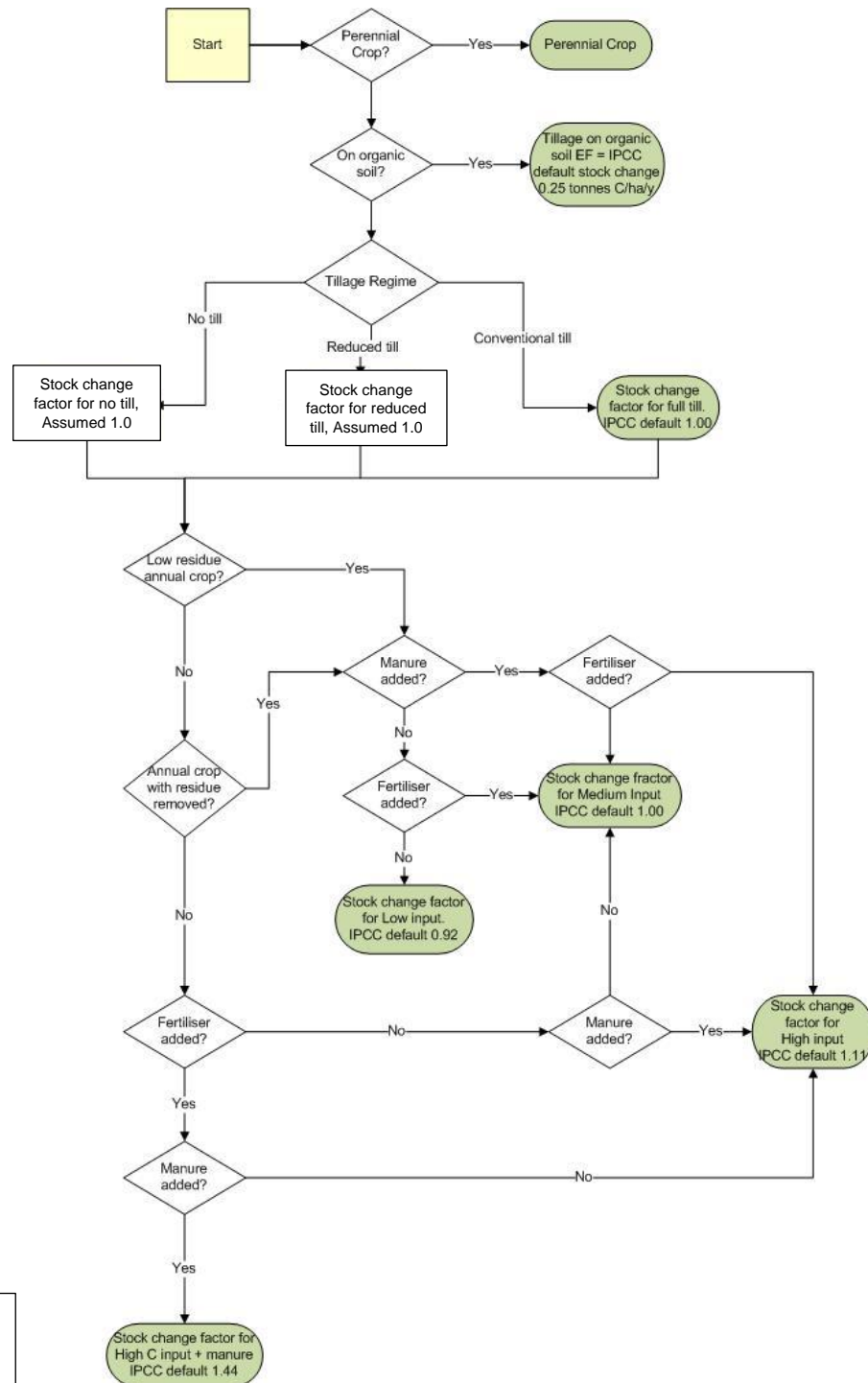
Using this methodology, tillage crops are divided into Medium and Low residue groups based on the data on total crop biomass. Where land receives inputs of fertiliser or manure the inputs moved up a class (e.g., cropland producing a Low residue crop which receives manure is considered to receive Medium inputs, while land producing a Medium residue crop which received manure inputs is considered to receive High inputs). If crop residues are removed from land the input level drops. A decision tree for assessing the effect of cropland management on soil carbon stocks is shown in **Figure A 3.13**.

For most cropland management activities there were insufficient UK field data to develop reliable Tier 2 stock change factors, and so Tier 1 factors have been used (for manure and residue inputs, and for differentiating perennial crops, annual crops and set-aside). These Tier 1 factors have been derived for soil carbon reference stocks of 0-30 cm depth (as opposed to the 1 m depth used in the land use change calculations. The 0-30 cm reference stocks for cropland soils are 70 tC/ha for England and Wales, 100 tC/ha for Northern Ireland and 120 tC/ha for Scotland. These values come from the same database of soil carbon density used for the land use change modelling. However, for tillage reduction both a literature review and modelling work suggested that it did not have a significant effect on soil carbon stocks, and that the Tier 1 stock change factors over-estimated its effect under UK conditions. Therefore, a stock change factor of 1 has been used for tillage reduction.

As changes in soil carbon stocks due to changes in cropland management are smaller than changes due to land use change the IPCC default transition time of 20 years is used.

Data on the areas under the main crop types is obtained from the annual June Agricultural Surveys/Census carried out by each UK administration (Defra; Welsh Government; Scottish Government; DAERA) and the annual Defra report on areas of crops grown for bioenergy. Data on the areas of cropland receiving inputs of manure, fertiliser and crop residues is obtained from the annual British Survey of Fertiliser Practice (Defra).

**Figure A 3.13** Decision tree for assessing the effects of cropland management activities on soil carbon stocks.



See Annex 3.4.6

**A 3.4.3.2.2** *Change in soil carbon stock due to grassland management activities*

Defra project SP1113 attempted to develop a methodology to allow reporting of changes in soil carbon stocks resulting from grassland management activities. There are reasonable data on the effects of management practices such as liming, reseeding and drainage on improved grassland

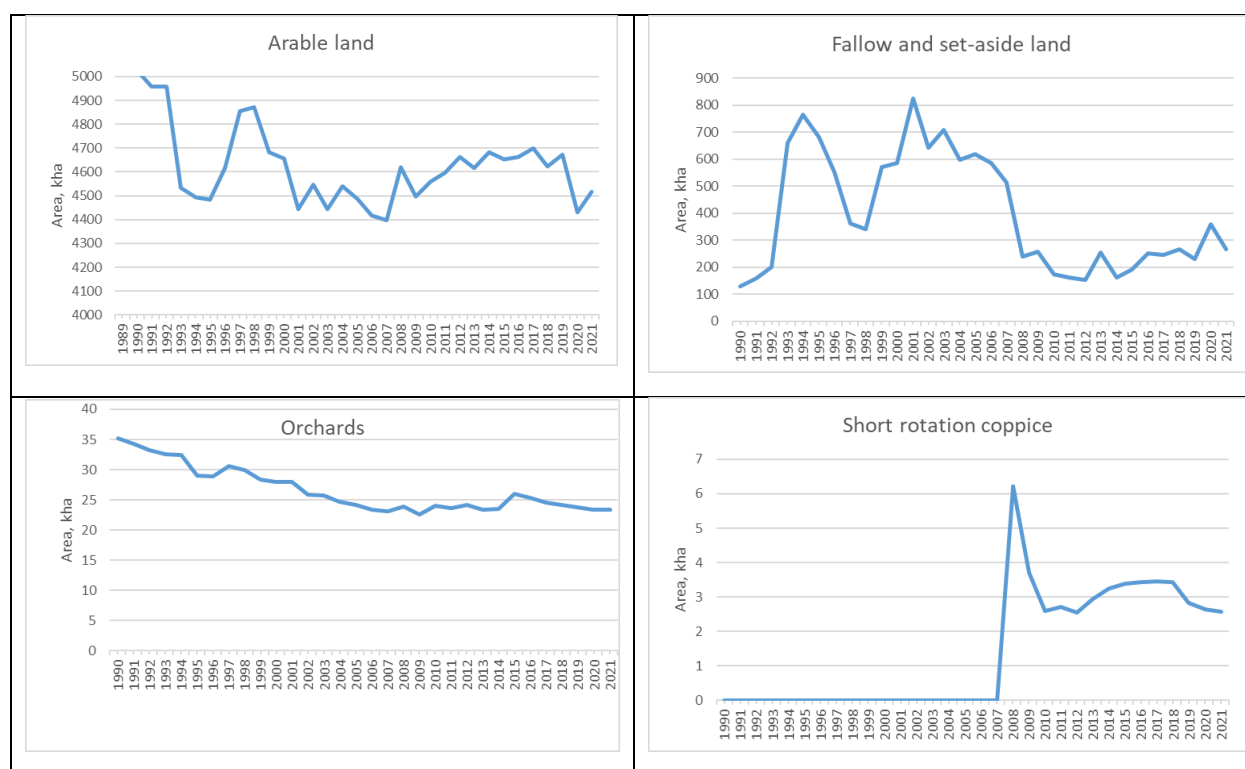
on mineral soils. However, there are few data on the effect of many management practices if applied to semi-natural grassland or those on organo-mineral or organic soils where there is a risk that more intensive management could increase carbon losses. As semi-natural grassland makes up a large proportion of grassland in the UK the lack of field data makes it impossible to reliably report changes in soil carbon stocks from grassland management activities. BEIS (now DESNZ) funded a research project to improve understanding of the effect of grassland management practices on soil carbon stock changes, which has not yet been published and work is ongoing in this area.

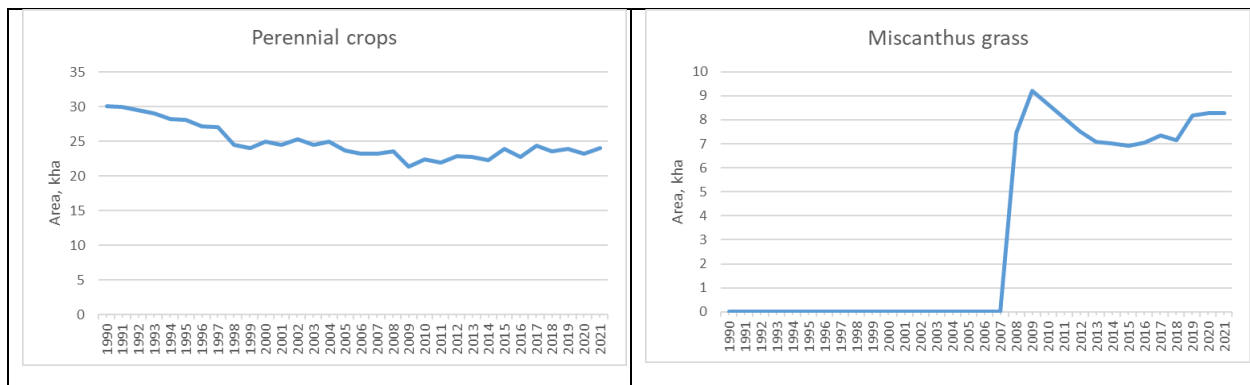
## **A 3.4.4 Changes in stocks of carbon in non-forest biomass due to management and land use change (4B2, 4C2, 4E2)**

### **A 3.4.4.1 Change in biomass carbon stock due to change in Cropland and Grassland Management.**

Change in Cropland biomass carbon stocks was assessed based on agricultural census data. Areas under different crop types were taken from annual agricultural census data and assigned on one of five categories: annual crops, orchard crops, shrubby perennial crops, perennial grassland used for biomass fuel (*Miscanthus*), short rotation coppice and set aside and fallow (**Figure A 3.14**). Crop types reported in the agricultural census vary slightly for each administration. **Table A 3.4.11** shows how agricultural census crop types were grouped to assess biomass carbon stocks. Areas of planting of *Miscanthus* and short rotation coppice are only available since 2007, when biomass crop incentives were introduced: any areas before 2007 were very small and for research purposes.

**Figure A 3.14 Crop type area in the UK 1990-2021**





**Table A 3.4.11 Aggregation of Agricultural Census crop types for estimating biomass carbon stock changes from Cropland Management**

Devolved Administration	Annual Crops	Orchard Crops	Shrubby perennial crops	Set Aside and Fallow
<b>England</b>	Cereals, Other arable not stockfeed, Crops for stockfeeding, Vegetables for Human Consumption	Orchard Fruit	Soft fruit, Hardy nursery stock, bulbs and flowers, Area under glass or plastic covered structures.	Uncropped land
<b>Scotland</b>	Cereals, Oilseed rape, Peas for combining, Beans for combining, Linseed, Potatoes, Crops for stockfeeding, Vegetables for human consumption, Other crops	Orchard fruit	Soft fruit	Fallow , Set Aside
<b>Wales</b>	Cereals, Other arable not for stockfeeding, Crops for stockfeeding, Salad and vegetables grown in the open, Total hardy crops	Commercial orchards, Other orchards	Glasshouse	Bare fallow
<b>Northern Ireland</b>	Cereals, Other arable not for stockfeeding, Vegetables	Fruit	Ornamentals	Fallow and set aside

The areas under each aggregated crop type were multiplied by the biomass carbon stock of each crop type using the biomass carbon stock factors in **Table A 3.4.12**. These factors were generated from a literature review. (Moxley *et al.* 2014b), except for Short Rotation Coppice, where the values came from IPCC 2019 Refinement Tables 4.4 and 5.3.

**Table A 3.4.12 Biomass stock factors for UK Cropland types**

Crop Type	Total biomass Carbon Stock t C/ha	Uncertainty t C/ha (95% CI)	Root: Shoot ratio
Annual	5	1.2	Assume no Below Ground Biomass.
Orchards	10	6.75	0.24
Shrubby perennial crops	3.7	2.0	Assume no Below Ground Biomass.
Short rotation coppice	7.57	2.54	0.192
<i>Miscanthus</i> grass	9.9	2.48	2.8
Set Aside and Fallow	5	1	4.0

Biomass carbon stock change was assumed to occur in the year in which the change in crop type was reported. Cropland biomass stock changes resulting from land use change to or from Cropland were subtracted from the changes due to change in cropland management, as they are accounted for under land use change.

Change in Grassland biomass carbon stocks was assessed based on Countryside Survey data, which is the most reliable source of change between different habitat types within a land category. Grassland was separated into shrubby, non-shrubby and unvegetated Grassland based on Countryside Survey Broad Habitat types. **Table A 3.4.13** shows which Broad Habitats were allocated to which Grassland type.

**Table A 3.4.13 Aggregation of Countryside Survey Broad Habitats for estimating biomass carbon stock changes from Grassland Management**

Shrubby Grassland	Non-shrubby Grassland	Unvegetated Grassland
Dwarf Shrub Heath Bracken Montane	Improved Pasture Improved Pasture Neutral Grassland Calcareous Grassland Acid Grassland Bogs	Littoral sediment Supra littoral sediment

The areas under each aggregated Grassland type were multiplied by the biomass carbon stock of each crop types using the biomass carbon stock factors in **Table A 3.4.14**. These factors were

generated from literature reviews (Moxley *et al.* 2014b). Only biomass carbon stock changes resulting from change between shrubby and non-shrubby Grassland were considered, as changes to and from unvegetated littoral and supra-littoral sediments were considered unlikely.

**Table A 3.4.14 Biomass stock factors for UK Grassland types**

Crop Type	Total biomass Carbon Stock t C/ha	Uncertainty t C/ha (95% CI)	Root: Shoot ratio
Non-shrubby Grassland	2.8	1.5	4.0
Shrubby Grassland.	10	3.6	0.53
Unvegetated Grassland	0	0	0
Managed hedge	34.86	68.75	0.3
Unmanaged hedge	175.3	476.6	0.3

Countryside Survey data are only collected on an approximately decadal basis. The annual stock change between survey years was estimated using linear interpolation. Biomass carbon stock change was assumed to occur in the year in which the change in Grassland type occurred. Grassland biomass stock changes resulting from land use change to or from Grassland were subtracted from the changes due to change in grassland management.

Change in Grassland biomass carbon stocks due to change in hedge length are included in the estimate of change in Grassland biomass carbon stock using Countryside Survey data on hedge length and condition. Hedges were divided into managed hedges which are trimmed to prevent the growth of large trees and unmanaged hedges which do not received routine maintenance. Unmanaged hedges do not fall within the UK’s definition of Forest, but may contain isolated trees and may also have some gaps in them. The biomass carbon stocks of managed and unmanaged hedges are estimated as the median of UK-relevant values in published literature, based on a literature review commissioned by BEIS (Moxley *et al.* 2014b) supplemented with more recent data. Full details of these values and data sources are included the Grassland Management Biomass calculation workbook.

**A 3.4.4.2 Change in biomass carbon stock due to land use change.**

Changes in stocks of carbon in biomass due to land use change are based on the all-soils area matrices (see previous section). The average biomass carbon density for Cropland, Grassland and Settlement are shown in **Table A 3.4.15**: these were derived from the distribution and biomass densities of the different crop and grassland types in each country of the UK. For Settlements the biomass stocks from Milne and Brown (1997) and land cover data from the 2007 Land Cover Map was used to assess the proportion of gardens, pasture-type grass (including sports pitches, golf courses and parks) and urban (built over) area within areas identified as Settlements.



The average change in biomass carbon density for each country is shown in **Table A 3.4.16 - Table A 3.4.19**. Changes between these equilibrium biomass carbon densities were assumed to happen in a single year.

**Table A 3.4.15 Mean biomass carbon stock densities, tC/ha**

Mean C stock tC/ha	Cropland	Grassland	Settlement
England	5.02	3.37	2.77
Scotland	5.00	4.16	2.91
Wales	5.03	3.61	2.81
Northern Ireland	5.14	2.93	2.64

**Table A 3.4.16 Weighted average change in equilibrium biomass carbon density (tC/ha) for changes between different land types in England**

From \ To	Forestland	Grassland	Cropland	Settlements
Forestland				
Grassland		0	-1.66	0.60
Cropland		1.66	0	2.25
Settlements		-0.60	-2.25	0

(Transitions to and from Forestland are considered elsewhere)

**Table A 3.4.17 Weighted average change in equilibrium biomass carbon density (tC/ha) for changes between different land types in Scotland.**

From \ To	Forestland	Grassland	Cropland	Settlements
Forestland				
Grassland		0	-0.83	1.25
Cropland		0.83	0	2.08
Settlements		-1.25	-2.08	0

(Transitions to and from Forestland are considered elsewhere)

**Table A 3.4.18 Weighted average change in equilibrium biomass carbon density(tC/ha) for changes between different land types in Wales.**

From / To	Forestland	Grassland	Cropland	Settlements
Forestland				
Grassland		0	-1.42	0.80
Cropland		1.42	0	2.22
Settlements		-0.80	-2.22	0

(Transitions to and from Forestland are considered elsewhere)

**Table A 3.4.19 Weighted average change in equilibrium biomass carbon density (tC/ha) for changes between different land types in Northern Ireland.**

From / To	Forestland	Grassland	Cropland	Settlements
Forestland				
Grassland		0	-2.21	0.29
Cropland		2.21	0	2.49
Settlements		-0.29	-2.49	0

(Transitions to and from Forestland are considered elsewhere)

Living biomass carbon stocks and Dead Organic Matter (DOM) stocks on Forest Land are modelled using CARBINE and used to calculate changes in carbon stocks due to conversions to and from Forest Land. When land is deforested to another land use, it is assumed that all living biomass and DOM is either converted to Harvested Wood Products or burnt on site in the year in which deforestation takes place. Increase in biomass carbon and DOM stocks on afforested land is modelled in CARBINE. Full details of CARBINE modelling of carbon stocks on Forest Land are given in **Section A 3.4.1.1**.

### **A 3.4.5 Carbon stock changes and biomass burning emissions due to Deforestation (4B, 4C, 4E, 4G)**

Deforestation is an activity that cuts across LULUCF categories, affecting net emissions and removals in all the land use categories. The process of land use change affects carbon stock changes in biomass and soil, and the woody material left after felling either moves into the harvested wood products pool or is assumed to be burnt on-site, resulting in immediate biomass burning emissions.

Levy and Milne (2004) discuss methods for estimating deforestation since 1990 using a number of data sources. Their approach of combining Forestry Commission felling licence data for rural

areas with Ordnance Survey data for non-rural areas was expanded to include new sources of information and to improve coverage of all countries in the UK. Deforestation before 1990 (which contributes to soil carbon stock change from historical land use change) is estimated from the land use change matrices described in **Section A 3.4.3**.

### **A 3.4.5.1 Types of deforestation activity in the UK**

In Great Britain, some activities that involve tree felling require permission from the Forestry Commission (FC), in the form of a felling licence, or a felling application within the various forestry grant schemes. There is a presumption that the felled areas will be restocked with trees, usually by replanting but sometimes by natural regeneration. However, some licences are granted without the requirement to restock – so-called unconditional felling licences. A felling licence is required unless special conditions are met<sup>29</sup>.

Felling for urban development, with no requirement to restock, can be allowed under planning permission but only local planning authorities hold documentation for this. Since 2006, remotely sensed data used in the NFI has included this change, but prior to this, the need for collation of data from local authorities makes estimating the national total difficult. However, in England, the Ordnance Survey (the national mapping agency) makes an annual assessment of land use change from the data it collects for map updating and provides this assessment to the Department for Levelling Up, Housing and Communities (DLUHC)<sup>30</sup>. DLUHC provides an extract of this dataset, listing annual land use change from Forest to developed land uses (1990-2008 in the latest submission). This dataset comes from a continuous rolling survey programme, both on the ground and from aerial photography. The changes reported each year may have actually occurred in any of the preceding 1-5 years. The survey frequency varies among areas, and can be up to 10 years for moorland/mountain areas. Consequently, for pre-2006 deforestation to Settlement a five-year moving average is applied to the data to smooth out the between-year variation appropriately, to give a suitable estimate with annual resolution.

### **A 3.4.5.2 Compilation of activity datasets**

Pre-1990 conversion of forest to other land categories is estimated using the land-use change matrices produced from the land-use data assimilation methodology (**Section A 3.4.3**)

For 1990-1999 the deforestation activity dataset is compiled from the felling licence and DLUHC datasets as far as possible, using Countryside Survey (CS) data to fill gaps in the time series, to estimate deforestation in Northern Ireland (for which no direct data are available) and to estimate the conversion to different land use categories. The DLUHC data are used to estimate the area of Forest Land converted to Settlement (4.E.2.1). The unconditional felling licence data are used to estimate the area of Forest Land converted to Cropland (4.B.2.1) and of Forest Land converted to Grassland (4.C.2.1). Only England has any post-1990 forest to cropland conversion: the estimated areas in Scotland, Wales and Northern Ireland are so small that they are thought to be due to survey classification error rather than genuine land use change.

The land-use change matrices from the data assimilation are used to estimate the relative split of Forest conversion between Grassland, Cropland and Settlements (**Table A 3.4.20**). **Table A**

---

<sup>29</sup> <https://www.gov.uk/guidance/tree-felling-licence-when-you-need-to-apply>

<sup>30</sup> <http://www.communities.gov.uk/planningandbuilding/planningbuilding/planningstatistics/landusechange/>

**3.4.21** shows the Corrected Forest conversion rates. A correction ratio is used to adjust the estimated deforestation areas, as the Countryside Survey is known to over-estimate deforestation as described in the section above. There are no non-CS data for Northern Ireland so the correction ratios for England or Wales are used, depending on availability.

The annual area of forest converted to other land uses is removed from the area of 4A1 Forest Land remaining Forest Land to maintain consistency in the land area matrix.

**Table A 3.4.20 Countryside Survey data for Forest conversion**

Years	Land change	England rate of change, kha/yr	Scotland rate of change, kha/yr	Wales rate of change, kha/yr	N Ireland rate of change, kha/yr	Grassland / Cropland split England	Grassland / Cropland split Scotland	Grassland / Cropland split Wales
1990-1998	Forest to Natural Grassland	5.600	4.418	1.099	0.171	0.61	0.86	0.72
	Forest to Pasture Grassland	3.081	0.608	0.418	0.086	0.33	0.14	0.28
	Forest to Cropland	0.545	0.097	0.019	0.008	0.06	0.00	0.00
	Forest to Settlements	1.242	0.293	0.132	0.072	-	-	-
	Forest to Other Land	0.169	0.231	0.058	0.025	-	-	-
1999-2007	Forest to Natural Grassland	2.656	10.327	0.120	0.209	0.86	0.98	0.42
	Forest to Pasture Grassland	0.277	0.186	0.162	0.102	0.09	0.02	0.58
	Forest to Cropland	0.141	0.006	0.001	0.001	0.05	0.00	0.00
	Forests to Settlements	0.617	0.098	0.095	0.142	-	-	-
	Forest to Other Land	0.430	0.695	0.374	0.027	-	-	-

**Table A 3.4.21 Corrected Forest conversion rates**

Years	Land type	England Correction ratio	Scotland Correction ratio	Wales Correction ratio	England rate of change, kha/yr	Scotland rate of change, kha/yr	Wales rate of change, kha/yr	N Ireland rate of change, kha/yr
1990-1998	Grassland & Cropland	2% <sup>a</sup>	-	-	0.159	0.088 <sup>c</sup>	0.026 <sup>c</sup>	0.005 <sup>c</sup>
	Settlements & Other Land	28% <sup>b</sup>	-	-	0.390	0.145 <sup>c</sup>	0.052 <sup>c</sup>	0.027 <sup>c</sup>
1999-2007	Grassland & Cropland	20% <sup>a</sup>	2% <sup>a</sup>	15% <sup>a</sup>	0.602	0.262	0.041	0.045 <sup>d</sup>
	Settlements & Other Land	28% <sup>b</sup>	-	-	0.296	0.224 <sup>c</sup>	0.133 <sup>c</sup>	0.048 <sup>c</sup>

<sup>a</sup> Unconditional felling licence data used for correction

<sup>b</sup> Land Use Change Statistics used for correction

<sup>c</sup> England correction ratio used

<sup>d</sup> Wales correction ratio used

For 2000 onward, the area and subsequent land-use of deforestation were estimated based on a combination of data sources:

- observations on forest loss by the NFI (internal Forestry Commission analysis) by IPCC category. This inventory includes an analysis of deforestation from 2006 to the current inventory year based on a new analysis of woodland maps (Forestry Commission, 2016);
- unconditional felling licences granted (assumed all converted to Grassland);
- analysis of the FC Sub-Compartment Database for restoration of Forest land to open habitats (conversion to Grassland or Wetland); and
- conversion to non-forest on private sector forest covered by long-term forest plans rather than felling licences (internal Forestry Commission report, assumed all converted to Grassland).

The revision in deforestation was only done from 2000 onwards, partly because there were no suitable data on which to base adjustments for 1990-1999, but also because a number of policy developments came into play in 2000 or shortly beforehand, which affected deforestation to restore open habitats or develop wind-farms. These include the introduction of the UK's climate change policy (2000), and the diversification in relevant forest policies in England, Scotland and

Wales following the devolution of forest policy to countries in the late 1990s (Matthews *et al.* 2014). The deforestation information used in this inventory is based on the assumptions used in the previous inventory, updated with the latest available information from the Forestry Commission on deforestation for recent years and to include estimates of areas deforested to allow rewetting to take place.

Soil carbon stock changes associated with deforestation are estimated using the dynamic soil carbon model described in **Section A 3.4.3**. When deforestation occurs, it is assumed that 60% of the standing biomass is removed as timber products and the remainder is burnt in the UNFCCC inventory. Country-specific forest biomass densities for living and dead organic matter from CARBINE are used. These densities change over time in relation to the forest age and species structure. Biomass losses are reported in the relevant carbon stock change tables, assuming a carbon fraction of 0.5 on a dry weight basis. The carbon removed as timber is reported as Harvested Wood Products (HWP) in 4G (described in **Section 6.8**).

Direct and indirect greenhouse gas emissions from associated biomass burning is estimated using the Tier 1 methodology described in the IPCC 2006 guidelines (IPCC 1997 a, b, c) and the emission ratios for CH<sub>4</sub>, CO, N<sub>2</sub>O and NO<sub>x</sub> from Table 3A.1.15 in the IPCC 2003 GPG for LULUCF. Only immediate losses are considered because sites are normally completely cleared, leaving no debris to decay.

### **A 3.4.6 Biomass Burning – Forest and Non-Forest Wildfires (4A, 4B, 4C)**

#### **A 3.4.6.1 Activity dataset**

Data on Forest wildfires prior to 2009 come from the Forestry Commission and the Forest Service of Northern Ireland.

In 2009 the Fire and Rescue Service (FRS) began recording wildfires in England, Scotland and Wales on a new Incidence and Reporting Systems (IRS) which includes wildfires on all land use categories. The IRS database contains 30 attributes for each fire to which a fire appliance was called, including date, spatial location, property type description (e.g. heathland and moorland, standing crop) and an estimate of the area burnt. This dataset is available from 1<sup>st</sup> April 2009. The original dataset had >126,000 fire records but 99% of these fires were less than 1 ha in size. The IRS database is manually completed by fire service personnel and its use requires some subjective judgement. This is likely to lead to non-systematic differences in the accuracy and precision of the data. The accuracy of the locations is variable, but an assessment of a number of the larger fires suggests that the land cover type attribute is reliable. The accuracy of the FRS burnt area estimates could not be validated using aerial photography as the available imagery was not recent enough, so Landsat images were used to validate the FRS data. However, it was still difficult to find cloud-free, pre- and post-fire images for fires in 2009. In addition, Landsat has been affected by image ‘striping’ since 2003, which affects the quality of the images and causes some data loss. There are issues with re-ignited fires or additional fires in the same area being logged in the database as separate events. Overall, the uncertainty associated with this dataset is high but should be re-assessed once a longer time series is available. A scoping study is underway in the DESNZ-funded GHG Inventory Improvement programme to assess available wildfire earth observation products.

To provide data on non-Forest wildfires prior to 2009, thermal anomaly data from the NASA-operated MODerate Resolution Imaging Spectroradiometer (MODIS) were obtained from the Fire Information Resource Management System (FIRMS) and allocated to land uses using the proportions of fire on each land use type from the Fire and Rescue Service IRS data. The correlation between MODIS data and IRS data breaks down below 25 ha, so for consistency a 25 ha threshold was set for reporting wildfires logged on the IRS.

Thermal anomalies usually represent active fires, but may also detect industrial heat sources, although these are typically masked out by the thermal anomaly processing chain. The IRS dataset records 89 fires > 25 ha occurring in 2010. The FIRMS dataset records 335 fire detections for the same period, however, the FIRMS detections may contain multiple detections for a single fire event and the FIRMS detections are for a single 1 km pixel, and do not have a straightforward conversion to burnt area. Searching the IRS and FIRMS data sets for temporally and spatially coincident events, using a 2 km buffer around the IRS data, suggests that 22 fires were recorded by both the IRS and FIRMS systems. There are wide discrepancies between the two datasets, reflecting their different natures. The IRS data set records fires where a fire service response was required, so does not record controlled burning, unless the fire gets out of control. The FIRMS dataset, however, responds to anomalous heat signatures, so records controlled and uncontrolled fires. However, in the UK controlled burning, which is primarily carried out for heath management, is only permitted between October and mid-April to reduce the risk of these burns running out of control (Natural England, 2014<sup>31</sup>; Scottish Government, 2011<sup>32</sup>). As the FIRMS thermal anomaly data is only collected between March and August it will not detect most fires from controlled burning. FIRMS is only able to detect fires under cloud-free or light cloud conditions and is also only able to detect fires alight at the time of the satellite overpass. The FIRMS data are more likely to detect larger fires than smaller ones, probably due to the stronger heat signature and the longer burn time that larger fires tend to exhibit.

The IRS and FIRMS thermal anomalies give a very different perspective on the extent, timing and duration of fire events in the UK. However, the datasets did show correlation ( $R^2 = 70-81\%$ ) for fires larger than 25 ha, which enabled an empirical relationship to be derived to extend the burnt area record back to 2001. A burnt area threshold of 25 hectares was used to extract a subset of the IRS database: this captured 75% of the IRS wildfire-burnt area in England, 86% in Scotland and 64% in Wales.

As more IRS data become available confidence should increase in the relationship between fires detected by FIRMS and fires logged in the IRS. This may allow FIRMS data to be extrapolated to fires covering less than 25 ha the inventory in future (although annual FIRMS data is no longer collected as of 2020). However to extend this to small fires there would need to be reasonable confidence that the ratio of large to small fires used was valid, and also some investigation of whether the distribution of small fires across land use classes was the same as that of larger fires.

It was assumed that all fires in the IRS database were wildfires: even if they started as controlled burning, because the need for a fire appliance call-out indicates that they are no longer under control. The IRS property type descriptions were assigned to LULUCF sub-categories (**Table A**

---

<sup>31</sup> <https://www.gov.uk/guidance/heather-and-grass-burning-apply-for-a-licence>

<sup>32</sup> <http://www.gov.scot/Resource/Doc/355582/0120117.pdf>

**3.4.22).** There is a very small area of wildfires that occur on Settlement types, and these are included in the Grassland category as the IRS land type classification suggests that they occur on grassy areas within Settlements and there is not a separate reporting field for wildfires in Settlements in the CRF.

**Table A 3.4.22 IRS database property type descriptions by LULUCF sub-category**

Forest	Cropland	Grassland	Settlement
Woodland/forest - conifers/softwood	Straw/stubble burning	Heathland or moorland	Domestic garden (vegetation fire)
Woodland/forest - broadleaf/hardwood	Stacked/baled crop	Grassland, pasture, grazing etc.	Park
	Nurseries, market garden	Scrub land	Roadside vegetation
	Standing crop	Tree scrub	Railway trackside vegetation
			Wasteland
			Canal/riverbank vegetation

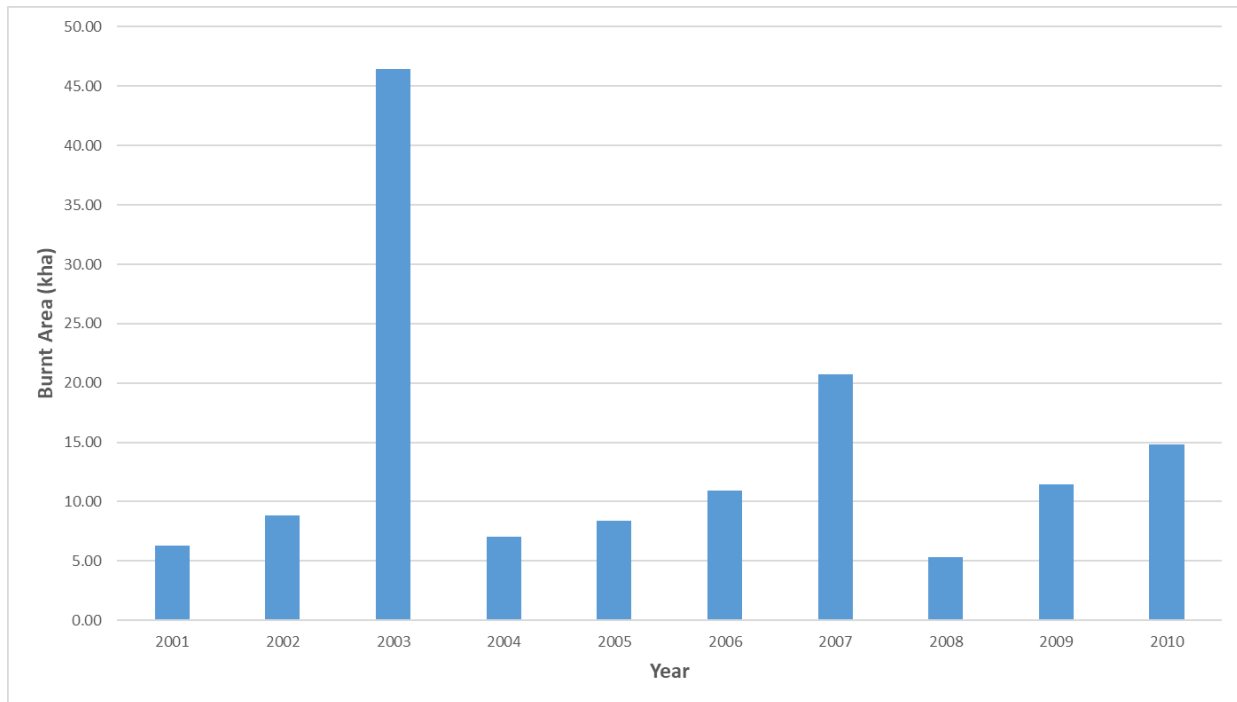
A time series of wildfire-burnt areas for each non-forest land use type was constructed for 1990-current inventory year (**Figure A 3.15**). For non-forest wildfires for England, Scotland and Wales the IRS burnt areas were used for 2009 to the current inventory year and the burnt area estimated from thermal anomalies from 2000 to 2008. For 1990-2000 the average annual burnt area 2001-2010 was used.

In Northern Ireland, where no IRS data were available, it was assumed that the heathland and grassland burning rates were in the same proportions as the Scottish burning rates, using the area of heathland and grassland from the 2007 Northern Ireland Countryside Survey.

Estimates of the forest area burnt in wildfires 1990-2004 are published in different locations (FAO/ECE 2002; FAO 2005) but all originate from either the Forestry Commission (Great Britain) or the Forest Service (Northern Ireland). There is a gap in the time series 2005-2010 for Great Britain but areas of forest wildfires are reported annually for Northern Ireland. The gap was filled using the annual average areas burnt 1995-2005. These areas refer only to fire damage in state forests; no information is collected on fire damage in privately owned forests. The proportion of private-owned forest that was burnt each year was assumed to be the same as the percentage of the state forest that was burnt each year.

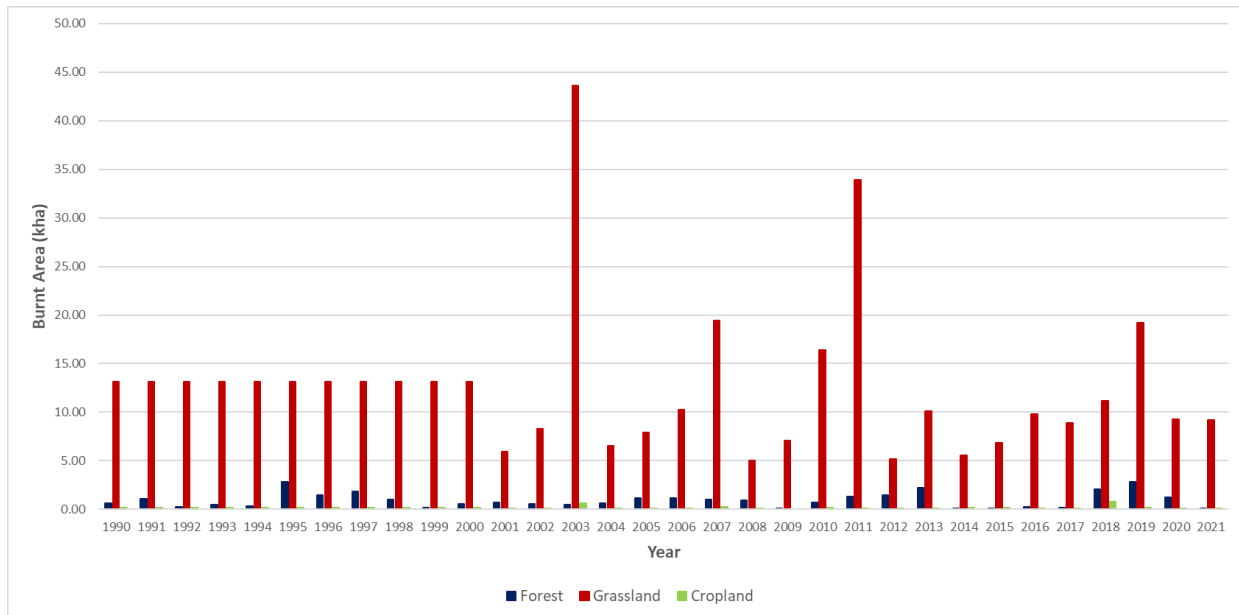


**Figure A 3.15** Annual area of FIRMS thermal anomalies for GB for 2001 to 2010 (thermal anomalies were filtered to exclude those recorded over urban/industrial areas).



**Figure A 3.15** shows the temporal pattern of FIRMS thermal anomalies, with peaks in hot dry years such as 2003. The FIRMS data used only includes thermal anomalies for March – August for each year, as these are the months where the IRS database recorded fires greater than 25 ha. Some FIRMS thermal anomalies were recorded outside these months due to FIRMS detecting both controlled burns and some fires less than 25 ha in size which are not included in the IRS data. As of the 1990-2020 inventory annual FIRMS data is no longer collected as only 2001-2010 data is used in biomass burning calculations and this remains constant. **Figure A 3.16** shows this 2001-2010 data.

**Figure A 3.16** Time series of wildfire burnt areas in the UK 1990 to the current inventory year



**A 3.4.6.2 Estimation of emissions**

The IPCC Tier 1 method is used for estimating emissions of CO<sub>2</sub> and non-CO<sub>2</sub> gases from wildfires (IPCC 2006). The *Calluna* heath fuel biomass consumption factor and grassland emission factors are used for heathland and moorland fires, the agricultural residues EFs for cropland and the “savannah and grassland” EFs for other grassland and settlements.

Country-specific biomass and Dead Organic Matter densities from the CARBINE model are used for estimating fuel consumption in forest fires (as discussed in the deforestation methodology section) and the ‘extra tropical forest’ EFs in the 2006 Guidelines. In line with the default value in the IPCC 2006 Guidelines for AFOLU it is assumed that 45% of the biomass is consumed in a wildfire in an unfelled temperate forest.

Emissions from all wildfires are reported under the ‘Land remaining Land’ categories (i.e. 4A1, 4B1 and 4C1) and IE reporting under 4A2, 4B2 and 4C2.

**A 3.4.6.3 Discussion of controlled burning in the Grassland category**

The UK does not report emissions from controlled burning on grassland, leading to a recommendation by the 2017 UNFCCC review team. Controlled burning in the UK context occurs in very small (<1 ha) scattered patches, and is undertaken to enhance vegetation productivity and forage quality, and to promote new growth to improve grazing for game species and livestock. Only controlled burning that spreads out of control would be captured in the wildfire reporting statistics.

A literature review of controlled burning in the UK and its Overseas Territories and Crown Dependencies was undertaken in 2018, to identify any new information and estimate GHG emissions if possible. This literature review was presented to the LULUCF Scientific Steering Committee and was shared with the 2021 UNFCCC review team. Its main findings are summarised here:

- The evidence for the overall impact of managed burning on moorland habitats in the UK is mixed with regard to the longer term GHG balance beyond the immediate combustion of vegetation
- Managed burning following the good practice guidelines should have a minimal impact on soils, with no release of GHGs. The longer-term impact on soil carbon stocks is contentious and evidence is not sufficient to produce a simple estimate of GHG emissions or removals from soil due to managed burning.
- Reasonable evidence for burning rates on upland moorland is available for England, but much less is available for Scotland, Wales and Northern Ireland, and it is not possible to construct a robust time series for the UK.
- Rates of burning across all moorland for each administration are low (less than the optimal rotation length for heather regeneration of 8-25 years), and the estimated GHG emissions/removals from biomass burning and regrowth are also low (see below).

An estimate of the GHG emissions from muirburn in each administration in 2015 (see **Table A 3.4.23**) was made using the areas of heather moorland for each country in the Land Cover Map 2015 (a subset of the area in the eastern regions is used for Scotland). An annual burn rate of 1% was used for Scotland, Wales and Northern Ireland and 3.88% for England. These burn rates are on the higher end of the burn rates identified by sources in the literature review. Both the emissions from burning and the carbon stock changes due to regrowth of vegetation are included in the GHG emission calculations. The IPCC 2006 Tier 1 fuel consumption, combustion factor and above-ground biomass for Calluna heathland have been used, with the Tier 1 emission factors for Savannah and grassland for CO<sub>2</sub>, CO, CH<sub>4</sub>, N<sub>2</sub>O and NO<sub>x</sub>.

**Table A 3.4.23 Estimated GHG emissions from controlled burning on Grassland, Gg**

	Annual area burnt, ha	Emission, Gg gas					Total GHG emissions
		CO <sub>2</sub>	CH <sub>4</sub>	N <sub>2</sub> O	CO	NO <sub>x</sub>	CO <sub>2</sub> e
England	6747	88.86	0.13	0.01	3.58	0.21	95.479
Scotland	4103	54.04	0.08	0.01	2.18	0.13	58.060
Wales	428	5.64	0.01	0.00	0.23	0.01	6.056
Northern Ireland	262	3.45	0.00	0.00	0.14	0.01	3.707
UK	11540	151.99	0.22	0.02	6.12	0.37	163.30

If the burning rate is fixed over time, the CO<sub>2</sub> emissions are largely compensated by the following regrowth. The regrowth of vegetation is assumed to increase linearly over an eight-year cycle, as by eight years burn scars become unidentifiable on aerial photography (this is not relevant if we are only able to assess an average rate of burning but will become so if there is variation in burning rates over time).

### **A 3.4.7 Emissions from organic soils (4A, 4B, 4C, 4D, 4E, 4(II))**

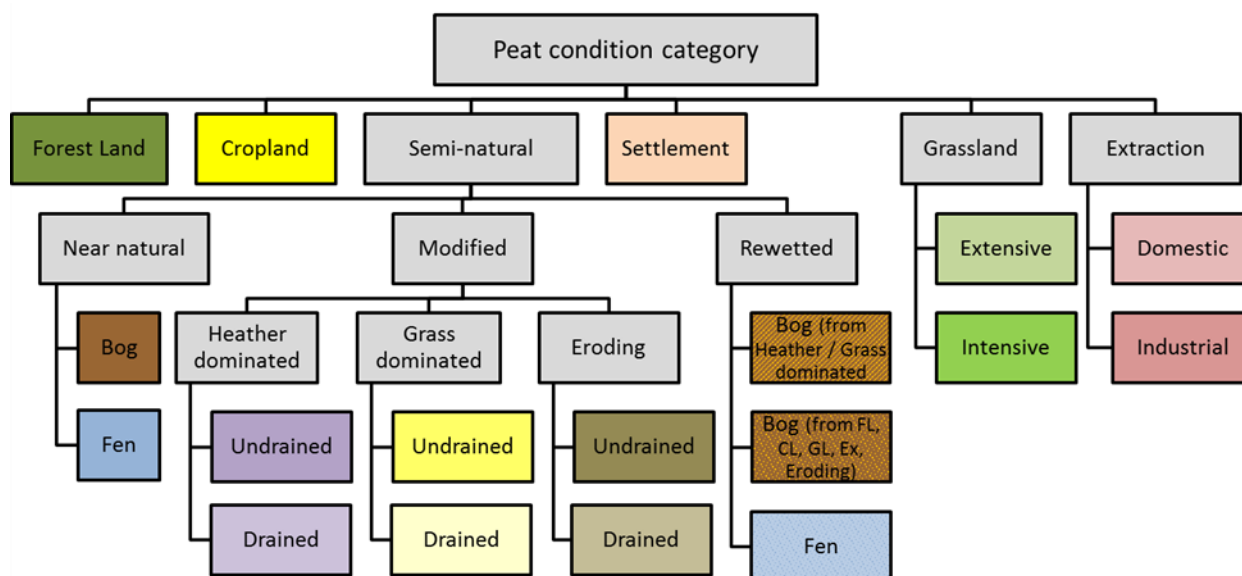
In a natural state, peatlands are important long-term sinks for carbon. However, drainage of peat can drastically alter the carbon balance in these systems, shifting them from a net sink to a net source of carbon. Peatlands comprise a high proportion of the total land area in the UK (~12%). Of these peatlands, around 76% are in a modified state and no longer functioning as a carbon (C) sink. This ranges from relatively minor changes in vegetation composition and hydrology and GHG emissions, through to deep drainage and replacement of the wetland vegetation for agriculture, forestry, and peat extraction practices that result in large sources of anthropogenic GHG emissions. The remaining 22% of peatlands in the UK are classified as near-natural bog or fen with suitable conditions for C sequestration, and 4% of UK peatlands have undergone restoration actions to restore normal peatland hydrology and biogeochemical functioning.

Prior to the 1990-2019 inventory, the UK's LULUCF inventory reported limited emissions from peatlands, namely direct CO<sub>2</sub> and N<sub>2</sub>O emissions arising from domestic and industrial extraction of peat, reservoir creation, conifer plantations on organic soils, and lowland drainage of cropland and agricultural grassland. Following the publication of the 2013 Supplement to the 2006 IPCC Guidelines, which provides methodology and default emission factors to allow calculation of GHG emissions and removals for a wider range of drained and rewetted peatlands (IPCC 2014), the UK elected to report Wetland Drainage and Rewetting (WDR) for the second commitment period of the Kyoto Protocol (KP). A BEIS-funded (now DESNZ) study on the Implementation of an Emission Inventory for UK Peatlands (Evans et al. 2017) was undertaken to provide activity data and a UK-specific Tier 2 emissions reporting approach for UK peatlands. This section summarizes the main results used to estimate emissions from organic soils in the LULUCF inventory and full details are available in Evans et al. (2017) on the NAEI website.

#### **A 3.4.7.1 Areas of organic soils**

Peatland soils occur in all LULUCF land categories in the UK apart from 4F Other Land. Peatland condition categories comprised near-natural bog and fen, semi-natural peatlands affected by human activity (such as drainage, controlled burning and livestock grazing), cropland, extensive and intensive grassland, woodland, domestic and industrial peat extraction areas and active peatland restoration (rewetted) areas of bog and fen. This classification encompasses peat condition categories in the UK that were sufficiently well mapped to derive emission factors (**Figure A 3.17**, **Table A 3.4.24**). Detailed descriptions of the activity data obtained from unified peat extent and land use maps, including key assumptions in the assignment of peat areas to condition categories, are given in Evans et al. (2017). Updates to activity data since the publication of the Evans et al (2017) peatlands implementation report include: the addition of a Settlement peat condition category; amendment to the Eroded Bog category to include only the actively eroding (bare peat) component of the landscape, with areas of not actively eroding bog captured under Modified Bog areas; and separate Rewetted categories for rewetted semi-natural Modified Bog, and more intensively modified peatlands (e.g. Forest, Cropland, Intensive and Extensive Grassland, Peat Extraction, Eroding Modified Bog) (**Figure A 3.17**), as well as updates due to land use change (detailed below, **Table A 3.4.24**). The peatlands defined in **Figure A 3.17** have all been altered by human interventions and practices to some extent, with natural peatlands managed for their high conservation value (e.g. SSSIs, SACs). Thus, emissions and removals from all managed UK peatlands are reported “*regardless of whether they are anthropogenic or non-anthropogenic*” (IPCC 2014, Section 1.3, Chapter 1).

**Figure A 3.17 Final land cover hierarchy used to derive a separate EFs for UK peatlands, amended from Evans et al (2017)**



Grey cells represent higher-level categories encompassing two or more sub-categories. Note that there are separate rewetted bog categories for transitions from heavily modified peatlands (Forest Land, Cropland, Grassland, Extraction, Eroding bog), and Semi-natural peatlands (Heather dominated and Grass dominated bogs).

Changes in peat condition were associated with restoration (rewetting) of peatlands, which has largely occurred in the UK since 2000, changes in peat extraction, and forestry. Most large-scale peatland drainage occurred prior to 1990, however some new drainage has occurred due to wind farm or settlement developments, but to date it has not been possible to acquire data to report these effects. Similarly, land-use transitions between cropland and grassland, or change between intensive and extensive grassland on organic soils could not be reliably quantified due to an absence of spatially explicit data.

Changes in peat extraction site area were generated from Google Earth satellite imagery and information on site operations data from Growing Media Association and applied to the baseline peat extraction areas (Evans et al. 2017) to give a time series of peat extraction area (see section 3.4.8). In contrast to the IPCC Tier 1 assumptions, fuel peat extraction was assumed to occur on nutrient-poor bog peat, and horticultural peat extraction on nutrient-rich fen peat, typical of UK practice (see Evans et al. 2017 for more detail).

Evans et al. (2017) reported spatial datasets of peatland restoration from 2000 to 2013. It was assumed that no rewetting activity took place before 2000 (other than peat extraction sites). An average rate of restoration was applied 2000 – 2013 due to limited temporal information. This annual rate has been extrapolated to the latest inventory year for England, Wales, and Northern Ireland, which is likely an underestimate given that funding for peatland restoration in the UK has increased in recent years. Efforts are underway to provide a reporting mechanism for recent rewetting activities. An annual timeseries of peatland restoration in Scotland 2013- latest inventory year was provided by Peatland Action, NatureScot. Estimates of changes in area of each peat condition due to rewetting between 1990 and the latest inventory year are shown by UK administration in Table A 3.4.25. An update to the total organic soil areas occurred in this

inventory, following a DESNZ (formerly BEIS) improvement project to edit and check the geometry of the maps and clarify activity data and the assumptions used to create the maps in Evans et al. (2017). Notably, this has included revision of the assumed planting on organic soils to adjust for deforestation (see Section 6.2.4), so that the total reported forest land on organic soils matches the estimates from the peat maps. The restoration data for intensive grassland was also revised to correct an over-estimate of intensive grassland to rewetted fen restoration in south-west England as identified in the Peatland Compendium dataset. Updated restoration data were supplied by Natural England and the RSPB (Table A 3.4.26).

**Table A 3.4.24 Assignment of peat areas (kha) to condition categories for each UK administration in 1990 and 2021.**

Country	England				Scotland		Wales		Northern Ireland		UK Total	
	Deep peat		Wasted peat		All	All	All	All	All	All	All	All
Year	1990	2021	1990	2021	1990	2021	1990	2021	1990	2021	1990	2021
Forest, D	48.38	50.62	13.15	13.86	332.75	359.61	9.51	9.36	27.98	31.61	431.76	465.06
Cropland, D	53.74	48.28	132.18	132.18	8.18	5.15	0.10	0.10	3.15	3.15	197.35	188.86
Eroding Modified Bog (bare peat), D	1.13	0.69	0.00	0.00	11.27	8.33	0.00	0.00	0.26	0.23	12.66	9.25
Eroding Modified Bog (bare peat), UD	6.66	6.53	0.00	0.00	29.72	28.65	0.03	0.03	0.69	0.65	37.09	35.86
Modified Bog (H.&G.dom), D	69.13	32.73	0.00	0.00	252.31	213.94	3.19	1.52	12.41	10.88	337.05	259.08
Modified Bog (H.&G.dom), UD	160.48	157.52	1.95	1.91	665.19	641.24	35.39	35.12	32.36	30.48	895.36	866.27
Extensive Grassland (combined bog + fen), D	4.01	0.19	0.53	0.52	31.39	32.34	8.98	1.81	4.88	3.87	49.78	38.73
Intensive Grassland, D	41.79	36.42	35.91	35.28	78.64	70.61	6.56	6.38	32.07	31.03	194.97	179.72
Near Natural Bog, UD	83.33	83.33	2.35	2.35	490.22	490.22	23.53	23.53	36.08	36.08	635.51	635.51
Near Natural Fen, UD	0.00	0.00	0.00	0.00	0.00	0.00	2.67	2.67	0.00	0.00	2.67	2.67
Extracted Domestic, D	4.26	4.25	0.14	0.14	44.92	44.65	0.00	0.00	91.57	87.27	140.90	136.31
Extracted Industrial, DI	6.93	1.31	0.00	0.00	2.88	2.43	0.00	0.00	0.50	0.68	10.31	4.43
Settlement, D	4.75	4.73	5.44	5.40	4.26	6.48	0.18	0.22	1.62	1.51	16.25	18.35
Rewetted Modified (Semi-natural) Bog, UD	1.69	37.22	0.00	0.00	0.00	29.29	0.00	1.64	0.00	0.83	1.69	68.98
Rewetted Bog, UD	0.08	4.13	0.00	0.00	0.00	16.74	0.00	5.15	0.36	4.99	0.44	31.01
Rewetted Fen, UD	0.88	19.25	0.00	0.00	0.00	2.04	0.00	2.61	0.03	0.70	0.91	24.61
<b>Total</b>	<b>487.22</b>	<b>487.22</b>	<b>191.64</b>	<b>191.64</b>	<b>1,951.73</b>	<b>1,951.73</b>	<b>90.16</b>	<b>90.16</b>	<b>243.96</b>	<b>243.96</b>	<b>2,964.71</b>	<b>2,964.71</b>

D= Drained, UD = Undrained, H.&G.dom = Heather and grass dominated

**Table A 3.4.25 Estimated changes in area (kha) of each peat condition category due to land-use change, drainage and rewetting between 1990 and 2021**

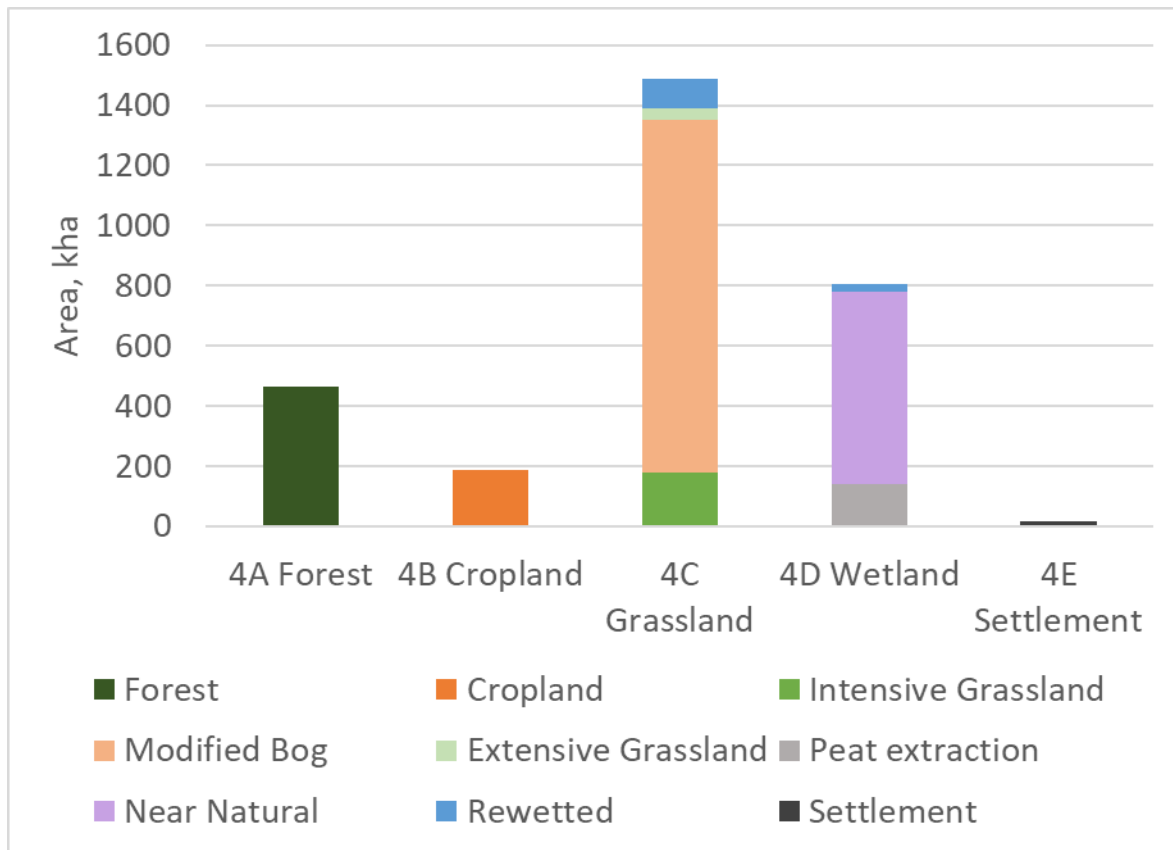
Tier 2 peat condition category	England Deep peat	England Wasted peat	Scotland	Wales	Northern Ireland	UK Total
Forest	2.242	0.708	26.866	-0.148	3.634	33.302

Tier 2 peat condition category	England Deep peat	England Wasted peat	Scotland	Wales	Northern Ireland	UK Total
Cropland	-5.457	0.000	-3.033	0.000	0.000	-8.489
Eroding Modified Bog (bare peat)	-0.561	0.000	-4.009	-0.002	-0.072	-4.644
Modified Bog (Heather + Grass dominated)	-39.346	-0.036	-62.318	-1.940	-3.419	-107.059
Extensive Grassland (combined bog + fen)	-3.814	-0.010	0.948	-7.169	-1.009	-11.055
Intensive Grassland	-5.371	-0.628	-8.036	-0.179	-1.043	-15.256
Near Natural Bog	0.000	0.000	0.000	0.000	0.000	0.000
Near Natural Fen	0.000	0.000	0.000	0.000	0.000	0.000
Extracted Domestic	-0.011	0.000	-0.268	0.000	-4.305	-4.583
Extracted Industrial	-5.615	0.000	-0.447	0.000	0.187	-5.875
Settlement	-0.016	-0.035	2.226	0.035	-0.108	2.103
<b>Change in drained area</b>	<b>-57.948</b>	<b>0.000</b>	<b>-48.071</b>	<b>-9.402</b>	<b>-6.136</b>	<b>-121.557</b>
Rewetted Modified (Semi-natural) Bog	35.527	0.000	29.287	1.644	0.829	67.287
Rewetted Bog	4.050	0.000	16.740	5.147	4.633	30.569
Rewetted Fen	18.371	0.000	2.044	2.611	0.674	23.700
<b>Change in rewetted area</b>	<b>57.948</b>	<b>0.000</b>	<b>48.071</b>	<b>9.402</b>	<b>6.136</b>	<b>121.557</b>

The peat condition categories are assigned to the LULUCF land categories with the majority area falling under Grassland or Wetland (**Figure A 3.18**):

- 4A Forest Land: Forest;
- 4B Cropland: Cropland;
- 4C Grassland: Eroding Modified Bog, Modified Bog, Extensive Grassland, Intensive Grassland, Rewetted Modified Bog (from Modified Bog), Rewetted Bog or Fen (from Eroding Modified Bog, Intensive and Extensive Grassland);
- 4D Wetland: Near Natural Bog/Fen, Extracted Domestic, Extracted Industrial, Rewetted Bog or Fen (from Forest Land, Cropland, Extracted Domestic, Extracted Industrial and pre-1990 Rewetted Fen),
- 4E Settlement: Settlement.

**Figure A 3.18** Area of land-use sub-categories on organic soils in 2021 in the UK



A large area of the cropland organic soil area in England is classified as shallow, wasted peat: former deep peat that has been partly lost through agricultural activity. GHG emissions from wasted peatlands are not well quantified so it has previously been assumed that wasted peat soils continue to emit at the same rate as deep peat, making these emissions estimates particularly uncertain. As such, the EFs for wasted peat are under review, with a BEIS-funded (now DESNZ) research project underway to measure GHG emissions from agriculturally managed wasted peat in England. Flux tower measurements from this study have been used to produce a new Tier 2 CO<sub>2</sub> EF for cropland on wasted peat for incorporation in this inventory (see Table A 3.4.26) (Evans et al., 2022b). At present, separate EFs for grassland on wasted peat cannot be derived due to lack of data, and measurements are ongoing for N<sub>2</sub>O.

Emission factors for organic soils

Tier 2 emission factors for the UK-relevant peat condition categories were initially developed by Evans et al. (2017). The EF literature review and meta-analysis was updated in 2019, and again in 2022 (see Evans et al. 2022a) to include recent GHG flux measurement publications and incorporate and generate the Tier 2 EFs given in **Table A 3.4.26**. Tier 2 EFs calculated from at least four different primary study locations were considered reliable enough to replace Tier 1 values (see detailed methods in Evans et al. 2017). Thus, where a Tier 1 EF is used in **Table A 3.4.26** the Tier 2 EF for that category was not reliable enough to replace the Tier 1 value (for instance, this means a Tier 1 CO<sub>2</sub> EF is still used for Domestic Peat Extraction). A continued Tier 3 approach for forestry carbon stock changes and fluxes on organic soils using the CARBINE



model has been used, with updates to the areas of organic soils used in the model, documented in **Section A 3.4.1**. Other GHGs from forested peat (CO<sub>2</sub> from dissolved organic carbon (DOC) and particulate organic carbon (POC), CH<sub>4</sub>, and N<sub>2</sub>O) are estimated using the EFs in **Table A 3.4.26**. A Tier 2 approach was used for most peatland categories for Direct CO<sub>2</sub>, Direct CH<sub>4</sub>, and Direct N<sub>2</sub>O. Limited studies were available for CH<sub>4</sub> from ditches, CO<sub>2</sub> from DOC, and CO<sub>2</sub> from POC, thus a Tier 1 approach was adopted until more UK-specific flux data are available. Comparisons of the direct emission factors adopted for each UK peat condition category are given in **Figure A 3.19-Figure A 3.21**. Furthermore, updates to the Tier 2 EFs developed by Evans et al. (2017) include EFs for Settlement, which uses the closest national condition category of drained organic soils assuming 50% garden (heather/shrub) using the EFs for Modified Bog, and 50% impermeable land (no emissions); amendment to the Eroded Modified Bog EF to represent emissions from actively Eroding Modified Bog (bare peat) only, with emissions from the not actively eroding bog captured by the EFs for Modified Bog; and an additional Rewetted EF for Rewetted Modified (Semi-natural Bog), described further in Section 3.4.6.3, which employs the EFs for Near Natural Bog.

**Table A 3.4.26 Emission factors, CO<sub>2</sub>, CH<sub>4</sub>, N<sub>2</sub>O, for peat condition types, given in t CO<sub>2</sub>-C ha<sup>-1</sup> y<sup>-1</sup>, kg CH<sub>4</sub> ha<sup>-1</sup> yr<sup>-1</sup>, and kg N<sub>2</sub>O-N ha<sup>-1</sup> yr<sup>-1</sup>, respectively (updated from Evans et al (2017) and Brown et. al. 2020, 2021). Total fluxes are shown in tCO<sub>2</sub>e ha<sup>-1</sup> yr<sup>-1</sup> using AR5 GWP with no feedbacks (CH<sub>4</sub>= 28, N<sub>2</sub>O = 265). A positive EF indicates net GHG emission, and a negative EF indicates net GHG removal. Note that the EFs for Direct CH<sub>4</sub> include a correction for CH<sub>4</sub> lost in ditches (1-fraction of ditches in the landscape) as per Equation 2.6 and Table 2.4 in IPCC (2014), where applicable (i.e. drained status). Combined standard errors are shown for the Total EFs in brackets.**

Peat Condition	Drainage status	Direct CO <sub>2</sub>	CO <sub>2</sub> from DOC	CO <sub>2</sub> from POC	Direct CH <sub>4</sub>	CH <sub>4</sub> from Ditches	Direct N <sub>2</sub> O	Total (± SE)
		t CO <sub>2</sub> -C ha <sup>-1</sup> y <sup>-1</sup>	t CO <sub>2</sub> -C ha <sup>-1</sup> y <sup>-1</sup>	t CO <sub>2</sub> -C ha <sup>-1</sup> y <sup>-1</sup>	kg CH <sub>4</sub> ha <sup>-1</sup> y <sup>-1</sup>	kg CH <sub>4</sub> ha <sup>-1</sup> y <sup>-1</sup>	kg N <sub>2</sub> O-N ha <sup>-1</sup> y <sup>-1</sup>	t CO <sub>2</sub> e ha <sup>-1</sup> yr <sup>-1</sup>
Forest	Drained	0.95 to -0.34 <sup>c</sup>	0.31 <sup>a</sup>	0.07 <sup>a</sup>	2.44 <sup>a</sup>	5.43 <sup>a</sup>	1.48 <sup>b</sup>	<b>5.72 to 0.98</b> (± 0.46 for DOC, POC, CH <sub>4</sub> and N <sub>2</sub> O, ±21% for direct CO <sub>2</sub> from CARBINE)
Cropland (peat > 40 cm)	Drained	7.38 <sup>b</sup>	0.31 <sup>a</sup>	0.14 <sup>a</sup>	1.86 <sup>b</sup>	58.25 <sup>a</sup>	16.28 <sup>b</sup>	<b>37.17</b> (±8.18)
Cropland (peat < 40 cm)	Drained	4.36 <sup>b</sup>	0.31 <sup>a</sup>	0.14 <sup>a</sup>	1.86 <sup>b</sup>	58.25 <sup>a</sup>	16.28 <sup>b</sup>	<b>26.10</b> (±2.67)
Eroding Modified Bog (bare peat)	Drained	1.48 <sup>b</sup>	0.31 <sup>a</sup>	2.80 <sup>a</sup>	40.59 <sup>b</sup>	27.10 <sup>a</sup>	0.30 <sup>a</sup>	<b>18.86</b> (± 1.07)
	Undrained	1.48 <sup>b</sup>	0.19 <sup>a</sup>	2.80 <sup>a</sup>	42.72 <sup>b</sup>	0 <sup>a</sup>	0.30 <sup>a</sup>	<b>17.72</b> (±1.00)
Modified Bog (semi-natural Heather + Grass dominated)	Drained	0.01 <sup>b</sup>	0.31 <sup>a</sup>	0.07 <sup>a</sup>	60.21 <sup>b</sup>	5.43 <sup>a</sup>	0.13 <sup>b</sup>	<b>3.32</b> (±0.73)
	Undrained	0.01 <sup>b</sup>	0.19 <sup>a</sup>	0 <sup>a</sup>	61.75 <sup>b</sup>	0 <sup>a</sup>	0.13 <sup>b</sup>	<b>2.51</b> (±0.73)
Extensive Grassland (combined bog/fen)	Drained	3.21 <sup>b</sup>	0.31 <sup>a</sup>	0.14 <sup>a</sup>	34.11 <sup>b</sup>	26.35 <sup>a</sup>	1.82 <sup>b</sup>	<b>15.88</b> (±3.38)
Intensive Grassland	Drained	4.06 <sup>b</sup>	0.31 <sup>a</sup>	0.14 <sup>a</sup>	27.58 <sup>b</sup>	58.25 <sup>a</sup>	7.39 <sup>b</sup>	<b>22.00</b> (±2.08)
Rewetted Bog	Rewetted	-0.16 <sup>b</sup>	0.24 <sup>a</sup>	0 <sup>a</sup>	111.11 <sup>b</sup>	0 <sup>a</sup>	0.03 <sup>b</sup>	<b>3.42</b> (±1.07)

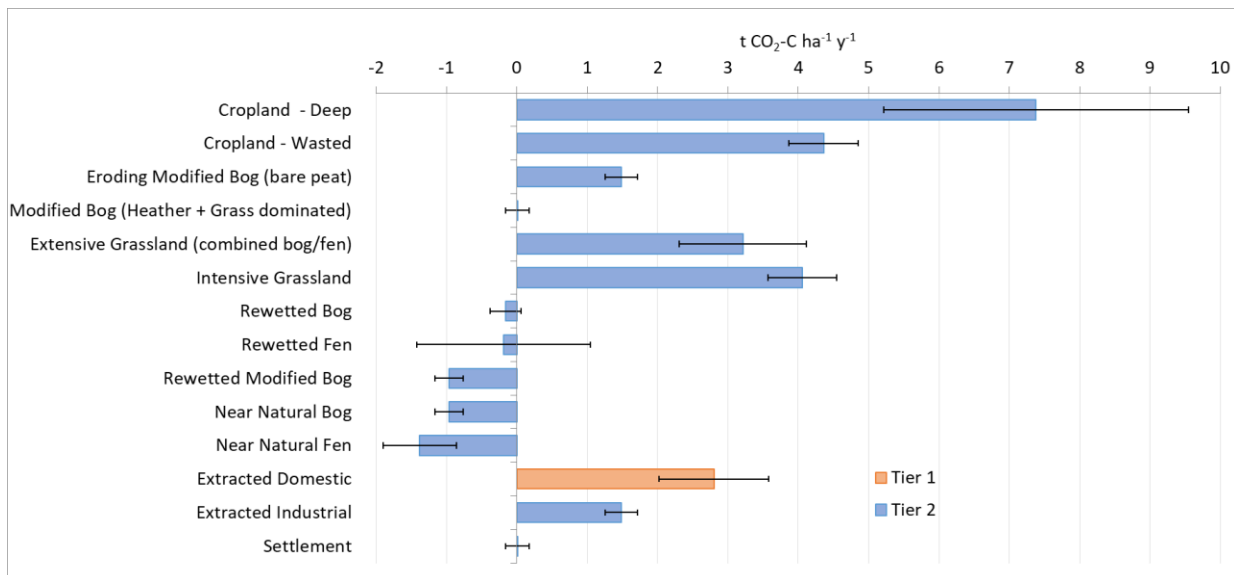
Peat Condition	Drainage status	Direct CO <sub>2</sub>	CO <sub>2</sub> from DOC	CO <sub>2</sub> from POC	Direct CH <sub>4</sub>	CH <sub>4</sub> from Ditches	Direct N <sub>2</sub> O	Total (± SE)
		<i>t CO<sub>2</sub>-C ha<sup>-1</sup> yr<sup>-1</sup></i>	<i>t CO<sub>2</sub>-C ha<sup>-1</sup> yr<sup>-1</sup></i>	<i>t CO<sub>2</sub>-C ha<sup>-1</sup> yr<sup>-1</sup></i>	<i>kg CH<sub>4</sub> ha<sup>-1</sup> yr<sup>-1</sup></i>	<i>kg CH<sub>4</sub> ha<sup>-1</sup> yr<sup>-1</sup></i>	<i>kg N<sub>2</sub>O-N ha<sup>-1</sup> yr<sup>-1</sup></i>	<i>t CO<sub>2</sub>e ha<sup>-1</sup> yr<sup>-1</sup></i>
Rewetted Fen	Rewetted	-0.19 <sup>b</sup>	0.24 <sup>a</sup>	0 <sup>a</sup>	111.44 <sup>b</sup>	0 <sup>a</sup>	0 <sup>a</sup>	<b>3.31</b> (±4.61)
Rewetted Modified (Semi-natural) Bog	Rewetted	-0.97 <sup>b</sup>	0.19 <sup>a</sup>	0 <sup>a</sup>	113.07 <sup>b</sup>	0 <sup>a</sup>	0 <sup>a</sup>	<b>0.32</b> (±1.17)
Near Natural Bog	Undrained	-0.97 <sup>b</sup>	0.19 <sup>a</sup>	0 <sup>a</sup>	113.07 <sup>b</sup>	0 <sup>a</sup>	0 <sup>a</sup>	<b>0.32</b> (±1.17)
Near Natural Fen	Undrained	-1.38 <sup>b</sup>	0.19 <sup>a</sup>	0 <sup>a</sup>	143.25 <sup>b</sup>	0 <sup>a</sup>	0 <sup>a</sup>	<b>-0.36</b> (±1.98)
Extracted Domestic	Drained	2.80 <sup>a</sup>	0.31 <sup>a</sup>	1.48 <sup>a</sup>	40.59 <sup>b</sup>	27.10 <sup>a</sup>	0.30 <sup>a</sup>	<b>15.18</b> (±2.94)
Extracted Industrial	Drained	1.48 <sup>b</sup>	0.31 <sup>a</sup>	2.80 <sup>a</sup>	40.59 <sup>b</sup>	27.10 <sup>a</sup>	0.30 <sup>a</sup>	<b>18.86</b> (±1.07)
Settlement	Drained	0.005 <sup>b</sup>	0.16 <sup>a</sup>	0.04 <sup>a</sup>	30.10 <sup>b</sup>	2.71 <sup>a</sup>	0.07 <sup>b</sup>	<b>1.66</b> (±0.73)

<sup>a</sup> Tier 1 default EF (IPCC 2014)

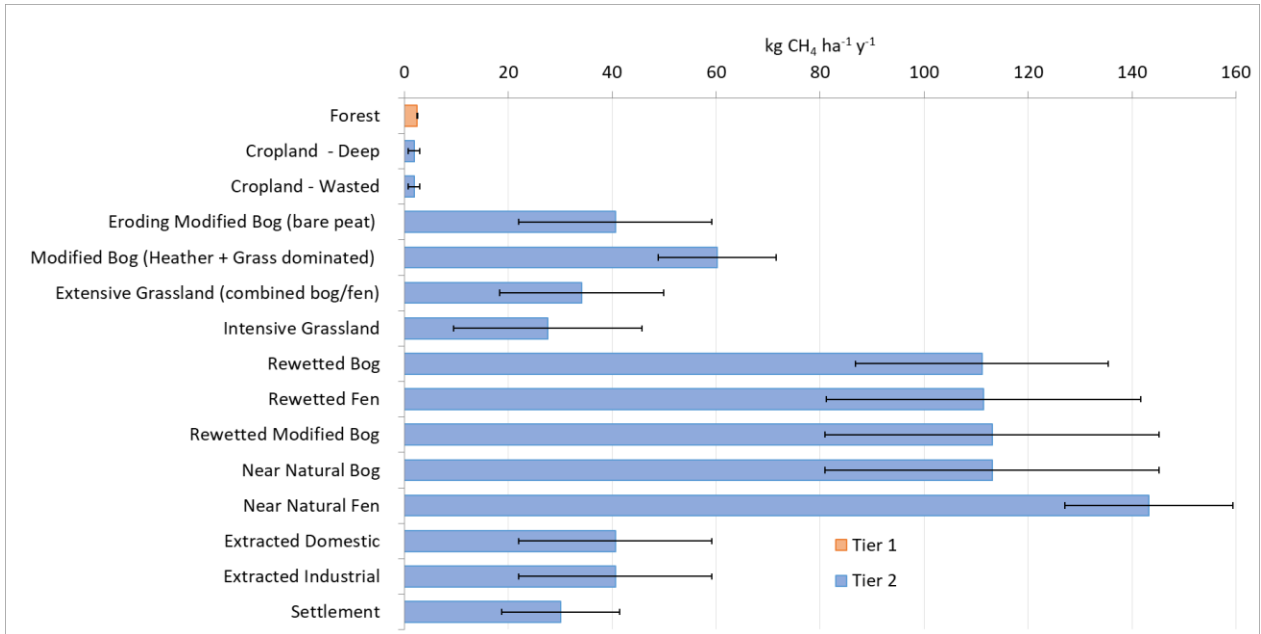
<sup>b</sup> Tier 2 EF (updated literature analysis in 2022 incorporating data from Evans et al. 2017; published in Evans et al. 2022a).

<sup>c</sup> Tier 3 Forest Research CARBINE model implied EF for 1990 to 2021. The decreasing trend is due to an increase in age of forests on organic soils due to decreasing afforestation on organic soils.

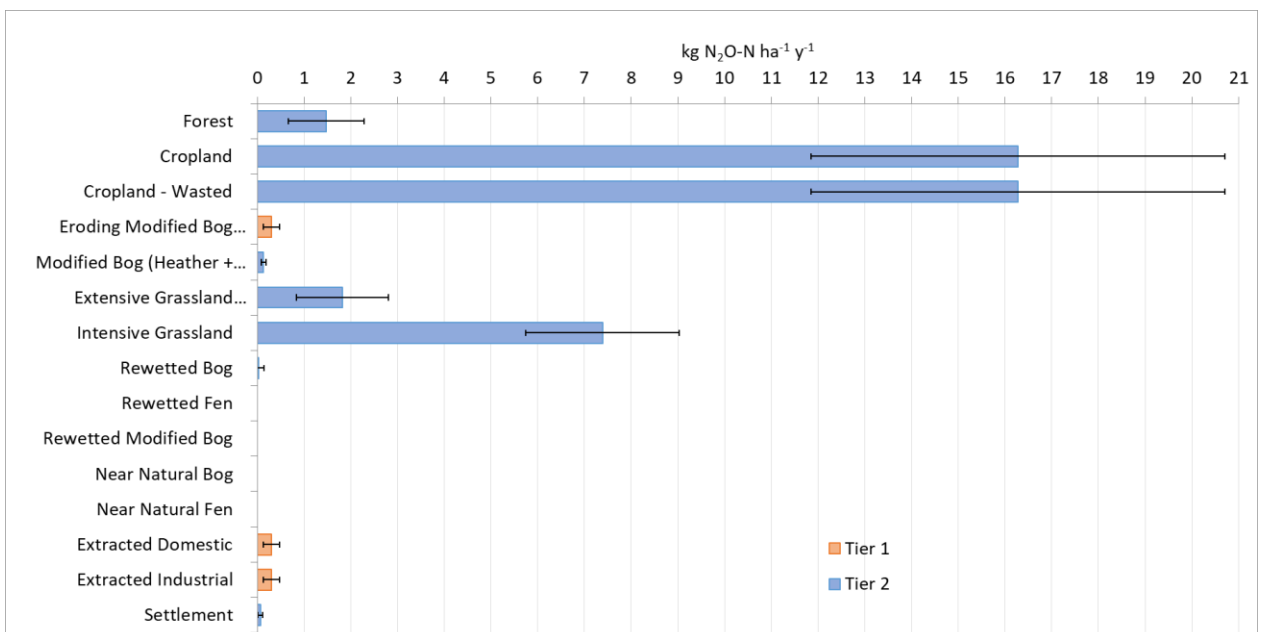
**Figure A 3.19 Direct CO<sub>2</sub> emission factors (Tier 1, 2, 3) for UK peat condition types updated from Evans et al (2017) ± standard error. Note that an EF for Forest is not shown as the Tier 3 method employed results in a range of EFs for forests on organic soils, which is due to changes in the age of forests and differences in afforestation over time. (All fluxes are shown in tCO<sub>2</sub>-C ha<sup>-1</sup> yr<sup>-1</sup>. Note that a positive EF indicates net GHG emission, and a negative EF indicates net GHG removal).**



**Figure A 3.20** Direct CH<sub>4</sub> emission factors (Tier 1 and 2) for UK peat condition types updated from Evans et al (2017) ± standard error. Note that the EFs for Direct CH<sub>4</sub> include a correction for CH<sub>4</sub> lost in ditches (1-fraction of ditches in the landscape) as per Equation 2.6 and Table 2.4 in IPCC (2014), where applicable (i.e. drained status). (All fluxes are shown in Kg CH<sub>4</sub> ha<sup>-1</sup> yr<sup>-1</sup>).



**Figure A 3.21** Direct N<sub>2</sub>O emission factors (Tier 1 and 2) for UK peat condition types updated from Evans et al (2017) ± standard error. (All fluxes are shown in Kg N<sub>2</sub>O-N ha<sup>-1</sup> yr<sup>-1</sup>).



Off-site CO<sub>2</sub> emissions from fluvial DOC exported from drained areas were estimated following 2014 IPCC Tier 1 methodology which incorporated a large body of UK data. A Tier 1 flux for POC exported from bare peat surfaces of 4 t C ha<sup>-1</sup> yr<sup>-1</sup> is given in Appendix 2a.1 of the IPCC Wetlands Supplement, based on studies on UK blanket bogs (Goulsbra et al., 2013). Using Equation 2.A1 in the Wetlands Supplement and a conversion factor for the proportion of POC mineralised to CO<sub>2</sub> of 70% (Evans et al., 2016), gives an emission factor of 2.8 t C ha<sup>-1</sup> yr<sup>-1</sup> (10.7 t CO<sub>2</sub>e ha<sup>-1</sup> yr<sup>-1</sup>) for bare peat surfaces (i.e. Eroding Modified Bog, and Industrial Peat Extraction), but with a high uncertainty. For other peatland condition categories, the POC EF for bare peat surfaces is multiplied by the fraction of exposed peat in the landscape using default drainage ditch fractions (Table 2.4 of the Wetlands Supplement), assuming that the proportion of land occupied by drainage ditches is equivalent to exposed bare peat. Indirect N<sub>2</sub>O emissions associated with nitrate leaching from organic soils were not incorporated at this time due to caution given in the 2006 and 2014 IPCC guidance against double-counting of emissions from fertilisation. A BEIS-funded (now DESNZ) research project to measure emissions from wasted peat under intensive agriculture will help to assess indirect emissions from N<sub>2</sub>O from organic soils. Findings from this study are expected in 2023 (see Evans et al. 2022b).

#### **A 3.4.7.2 Emissions from drainage and rewetting (4(II))**

Large areas of UK peatlands, predominantly semi-natural heather- and grass-dominated bog, are modified by grazing and burning-management practices but remain undrained. As these habitats are a net source of GHG emissions (**Table A 3.4.13**), and no guidance is given in IPCC (2014) for modified undrained peatlands, Tier 2 emissions factors were developed to capture undrained peat condition categories.

Separate emissions factors were developed for rewetted semi-natural, heather and grass dominated bog (rewetted total EF = 0.32 ± 1.17 tCO<sub>2</sub>e ha<sup>-1</sup> yr<sup>-1</sup>), and more intensively modified peatlands, which includes forest, cropland, intensive/extensive grassland, extracted, and eroding modified bog, (total EFs of 3.42 ± 1.07 and 3.31 ± 4.61 tCO<sub>2</sub>e ha<sup>-1</sup> yr<sup>-1</sup> for rewetted bog and fen, respectively) to take account of the different scale of damage to these lands, and the greater ease and effectiveness of rewetting of habitats that already have semi-natural vegetation and are functioning in a near-healthy state (**Table A 3.4.13**).

N<sub>2</sub>O emissions from cropland and intensive grassland are calculated using the EFs in **Table A 3.4.26** and reported under the Agriculture sector category of 3.D- Agricultural Soils, as these agricultural land types are considered to be highly cultivated and this is consistent with the approach taken in the Agriculture sector. N<sub>2</sub>O emissions from unintensified grassland on organic soils are reported under 4(II)/4.H to ensure completeness, as it is not possible to report these emissions in the 4(II)/4.C rows in the CRF tables.

#### **A 3.4.7.3 Uncertainties**

The uncertainties associated with the areas and emission factors from organic soils were assessed as part of the Evans et al. (2017) research and subsequent updates.

The uncertainties associated with areas were not quantifiable (as there were limited data sources available) so expert judgement was used to assign estimated uncertainties to peatland condition classes.

- Low uncertainty (10%): rewetted Grassland, rewetted and near-natural Wetland;

- Medium uncertainty (30%): drained Cropland >40cm depth, drained intensive Grassland, industrial peat extraction on Wetland, Settlement;
- Medium uncertainty (42%): drained and undrained modified bog and eroding modified bog Grassland;
- High uncertainty (60%): all condition classes on wasted peat, drained extensive grassland, domestic peat extraction on Wetland.

Uncertainties for the Tier 2 emission factors were calculated from the 95% confidence interval for CO<sub>2</sub>, CH<sub>4</sub> and N<sub>2</sub>O from the 2022 emission factor meta-analysis (see Evans et al. 2022a) and taken from the IPCC 2013 guidance for Tier 1 factors. The combined uncertainties for organic soils by LULUCF category are included in **Section A 3.4.12**. The uncertainties for forest on organic soil are calculated as part of the overall Forest uncertainty, as this uses a Tier 3 model rather than an emission factor approach. Settlements on organic soils were not included in the Evans et al. 2017 research, but their uncertainty is assumed to be Medium/High based on expert judgement. Emissions of N<sub>2</sub>O due to disturbance associated with land use conversion and land management changes (4(III)).

All land use conversions or land management changes that result in a loss of soil carbon, leading to N mineralization and N<sub>2</sub>O emissions, are reported. Direct emissions from soils, and indirect emissions from nitrogen leached from soil and subsequently oxidised are included in the inventory. The UK now includes emissions resulting from the land use conversions: 4A2 Land converted to Forest Land, 4B2 Forest to Cropland and Grassland to Cropland, 4C1 Grassland remaining Grassland, 4C2 Forest to Grassland, 4E1 Settlement remaining Settlement and 4E2 Land converted to Settlement. Emissions of N<sub>2</sub>O from 4C1 and 4E1 arise from land use change over 20 years before the inventory reporting year where loss of soil organic matter is still ongoing. Emissions of N<sub>2</sub>O from 4B1 Cropland remaining Cropland (resulting from land use change over 20 years before the inventory year) are calculated in the same way by the LULUCF inventory team but are included in the Agriculture sector (category 3D1).

The Tier 1 methodology described in the IPCC 2006 Guidelines is used. The activity data are the areas and soil carbon stock changes reported in the relevant categories in 4A2, 4B, 4C and 4E. Some C:N ratios for UK soil/vegetation combinations are published in the Countryside Survey (with values of 11.7 to 13.4) but only for the top 15 cm of soil. However, the soil carbon stock changes reported in the inventory are from the top 1 m of soil, so these C:N ratios were not felt to be applicable. Therefore, the IPCC default C:N ratio of 15 is used for estimating mineralised N. The emission factor of 1% in the 2006 Guidelines was used to estimate N<sub>2</sub>O emissions from mineralised N. Indirect N<sub>2</sub>O emissions from mineralisation are also estimated from carbon stock change using Tier 1 methodology.

### **A 3.4.8 On-site and off-site emissions from peat extraction (4D)**

On-site emissions of CO<sub>2</sub> and N<sub>2</sub>O from peat extraction activities (for energy and horticultural use) and off-site emissions of CO<sub>2</sub> from the decomposition of horticultural peat are reported in category 4D.

#### **A 3.4.8.1 Activity datasets**

Available data sets on peat extraction vary between Northern Ireland and for Great Britain (England, Scotland and Wales). From 2002 onwards Google Earth imagery has been used to estimate the area of peat extraction from sites listed in the Directory of Mines and Quarries and

the BritPits online database<sup>33</sup>, supplemented with recent ground-truthed site information from Growing Media Association. Prior to the 2002 no Google Earth images are available, and peat extraction site areas have been estimated from other sources. **Table A 3.4.27** shows the sources of activity data used to estimate emissions from peat extraction.

**Table A 3.4.27 Activity data for peat extraction sites in Northern Ireland**

<b>Data set</b>	<b>Information contained</b>	<b>Geographic extent</b>	<b>Time period</b>	<b>Publication frequency</b>
Directory of Mines and Quarries (DMQ)/BritPits database	Location of active peat extraction sites	England, Scotland, Wales, Northern Ireland	1984 - present	Online database is continuously updated
Google Earth	Land use images to estimate area of extraction sites identified from DMQ	UK	2002 - present	Variable
Growing Media Association	Location, area estimates, and site history of peat extraction sites.	UK	present	Variable
Cruickshank and Tomlinson (1997)	Area with planning consent for peat extraction Local authority planning consents for peat extraction sites	England, Scotland, Wales	1990/91	One off compilation of data
Tomlinson (2010)	Estimate of peat extraction area in Northern Ireland.  Volume of peat extracted (sod cutting and vacuum harvesting)	Northern Ireland	1990 - 1991	One off compilation of data
Mineral Extraction in Great Britain (Annual Minerals Raised Inquiry)	Volume of peat extracted	England, Scotland, Wales	1947 - date	Annual
Cruickshank et al. 1995	Volume of peat extracted (hand cutting)	Northern Ireland	1990 - 1991	One off compilation of data
GMA (2021)	Volume of horticultural peat sold in the UK	England, Scotland, Wales	2011 - 2021	Variable

<sup>33</sup> <https://www.bgs.ac.uk/products/minerals/britpits.html>

The areas of peat extraction sites listed in the BritPits database were assessed using Google Earth. Polygons were drawn around site boundaries and the area covered by the polygons was calculated in Google Earth. Change over time at individual sites was tracked to give an estimate of the extent of conversion to and from extraction sites. This method is repeated annually to incorporate changes in extraction site areas in new Google Earth images.

It is assumed that extraction areas continue to produce emissions while there is visible evidence of exposed peat soil from Google Earth satellite imagery, and do not convert back to functioning peatlands without restoration intervention. An extraction site is considered to have ceased emissions when there is visible evidence of the re-establishment of vegetation cover on the satellite imagery and evidence of rewetting (ditch blocking) from online documentation of the restoration works and communication with site managers. Additional information on active peat extraction areas and site history are provided by UK Growing Media Association.

Annual peat production in Great Britain (Table A 3.4.28) is inferred from extractor sales by volume as published in the annual Mineral Extraction in Great Britain report, formerly known as the Minerals Raised Inquiry (ONS). This gives a breakdown for horticultural and other uses of peat, which are assumed to be fuel, for English regions and for Scotland. No peat extraction is reported in Wales. Annual production is highly variable because extraction methods depend on suitable summer weather for drying peat. Data are available from 1990-2014. For the period 2015-2021, UK sales volumes of horticultural peat are derived from the Growing Media Association report (GMA, 2021).

**Table A 3.4.28 Annual peat production, m<sup>3</sup> for England and Scotland (from Annual Minerals Raised Inquiry/Mineral Extraction in Great Britain reports, and GMA, 2021)**

Year	England Horticultural	England Fuel	Scotland Horticultural	Scotland Fuel
1990	1,116,940	2,727	293,170	93,163
1991	1,202,000	2,000	241,000	115,000
1992	1,079,000	4,000	332,000	91,000
1993	1,069,820	2,180	306,511	73,489
1994	1,375,000	1,000	498,000	108,000
1995	1,578,000	2,000	657,000	44,000
1996	1,313,000	2,000	517,000	53,000
1997	1,227,000	2,000	332,000	59,000
1998	936,000	0	107,000	32,000
1999	1,224,000	0	392,000	37,000
2000	1,258,000	1,000	336,000	31,000
2001	1,459,000	1,000	325,000	30,000
2002	856,000	1,000	107,000	10,000

Year	England Horticultural	England Fuel	Scotland Horticultural	Scotland Fuel
2003	1,227,000	1,000	741,000	38,000
2004	902,000	1,000	338,000	21,000
2005	927,000	1,000	550,716	26,284
2006	856,000	1,000	712,000	24,000
2007	654,000	0	221,000	10,000
2008	496,000	0	243,000	21,000
2009	476,000	0	390,000	21,000
2010	456,000	1,000	527,000	21,000
2011	429,000	0	369,000	26,000
2012	422,000	0	146,000	20,000
2013	661,000	0	594,000	24,000
2014	294,000	0	501,000	32,000
2015	277,694	0	390,953	22,528**
2016	247,080*	0	347,341*	22,528**
2017	216,465*	0	303,729*	22,528**
2018	185,851	0	260,117	22,528**
2019	134,322	0	243,671	22,528**
2020	253,711	0	282,162	22,528**
2021	69,422	0	272,918	22,528**

\*Linear interpolation between 2015-2018 used in absence of measured horticultural peat volume data. \*\* Actual data for fuel peat are not available 2015-2021. Volumes are 2005-2014 average except for Fuel peat in England which is assumed to be zero as there are no longer any sites licenced for this activity.

#### A 3.4.8.2 Estimation of emissions

Tier 1 and Tier 2 emission factors are used to estimate on-site emissions for CO<sub>2</sub>, CH<sub>4</sub> and N<sub>2</sub>O (see **Section A 3.4.6.2**).

A value of 0.0641 tonnes C m<sup>-3</sup> is used for Great Britain to estimate emissions from extracted horticultural peat volumes based on previous work (Thomson *et al*, 2011).

Tomlinson (2010) gives production estimates of horticultural peat production for Northern Ireland for 1990/91 and 2007/2008. These have been interpolated to produce a time series. The total emission from horticultural peat production is the sum of emissions from vacuum harvesting production, sod extraction production and mechanical extraction production.

Emissions from vacuum harvesting production =

$$\text{area} * \text{annual depth of extraction} * \text{carbon fraction by volume}$$



where

*Annual depth of extraction by vacuum harvesting, m/ha = 0.1*

*Carbon fraction of air-dry peat by volume, tonnes C/m<sup>3</sup> air-dry peat = 0.0641*

Emissions from sod extraction production =

$\text{area} * \text{sod extraction rate} * \% \text{ dry matter for sods} * \text{mean \% C}$

where

*Sod extraction rate, tonnes/ha/yr = 200*

*Sod extraction, mean % dry matter = 35%*

*Mean % carbon = 49%*

Emissions from mechanical extraction production =

$\text{area} * \text{extraction rate} * \% \text{ dry matter for mechanical extraction} * \text{mean \% C}$

where

*The mechanical extraction rate was estimated to be 206.45 tonnes/ha in 1990/91 and 243.06 tonnes/ha in 2007/08 (Tomlinson, 2010).*

*Mechanical extraction, mean % dry matter = 67%*

*Mean % carbon = 49%*

### **A 3.4.9 Flooded Lands (4D)**

Carbon stock changes on land converted to Flooded Land (reservoirs) are included in the inventory, based on the IPCC 2006 Guidance. Data on all reservoirs over 1 km<sup>2</sup> were compiled but only reservoirs established since 1990 were reported (areas of inland water under 1 km<sup>2</sup> are reported under 4D Wetlands remaining Wetlands). Activity data were compiled for England and Wales from the Public Register of Large Raised Reservoirs provided by the Environment Agency, which listed location, surface area and year built. Activity data for Scotland were compiled from the SEPA Water Body Classification database (of water bodies > 0.5 km<sup>2</sup>) and the associated Water Body data sheets. Additional information on the year of building was obtained from:

- the Gazetteer for Scotland <http://www.scottish-places.info>;
- hydro-electric power generators <http://sse.com/whatwedo/ourprojectsandassets/http://www.power-technology.com/projects/glendoehydropowerpla/>; and
- local authorities <http://www.argyll-bute.gov.uk> .

It was established through discussion with local experts that no new large reservoirs had been built in Northern Ireland since the 1950s.

Only five large reservoirs have been established in the UK since 1990, three in England and one each in Scotland and Wales (another five in England are sacrificial floodplains and do not fit the criteria of permanent conversion to Flooded Land). These cover a total of 1.995 kha.

The location of each reservoir was examined using the [www.magic.gov.uk](http://www.magic.gov.uk) geographic information portal. All reservoirs were in upland locations and were assumed to be Grassland prior to their conversion to Flooded Land. (Any forest removed as part of the land conversion will have been captured under the deforestation activity methodology). A Tier 1 methodology was followed, so carbon stock changes in living biomass stock in the year of flooding were estimated, but not carbon stock change in soils. The UK biomass carbon stock of shrubby grassland (10 t C/ha) was used for consistency with other parts of the LULUCF inventory.

### **A 3.4.10 Harvested Wood Products (4G)**

The activity data used for calculating this activity are the annual forest planting rates. CARBINE then applies a forest management regime as given in input to the model. For a given forest stand, carbon enters the HWP pool when thinning is undertaken and when harvesting takes place. Depending on the species, first thinning occurs approximately 20 years after planting.

During wood extraction, conversion losses are assumed to be left as on-site harvest residue and enter the litter pool. The allocation of carbon to wood product categories is estimated by allocating the merchantable stem carbon to woodfuel, paper, wood-based panels and sawnwood, based on yearly proportions derived from reported forestry statistics. The CARBINE model uses standard estimates for oven-dried wood density to derive biomass from the harvested volume (Lavers and Moore, 1983; Jenkins et al., 2011). Carbon content of all oven-dried wood is assumed to be 50% (Matthews, 1993). CARBINE assumes the wood of a tree species all has the same oven-dried wood density and carbon content, irrespective of which semi-finished wood product categories it is assigned to.

The proportions of wood produced which are allocated to different product categories are based on proportions derived from FAO data<sup>34</sup> (prior to 1994) and forestry commission data<sup>35</sup> (after 1993) on production of semi-finished wood products. A carbon retention curve is used to estimate product decay and return of carbon to the atmosphere. Each wood product category has its own carbon retention curve using the default half-lives in the IPCC 2013 Revised Supplementary Methods and Good Practice Guidance, taking into account the decay rate of wood products and the service life as influenced by socio-economic factors. The half-lives are: 35 years for sawn wood; 25 years for wood panels; 2 years for paper. Timber used as woodfuel is assumed to instantaneously oxidise.

In implementing the 2006 IPCC guidelines for HWP the UK has elected to report using the production approach B2, which requires disaggregation of HWP into those produced and consumed domestically and those produced and exported. In the annual Forestry Statistics publication, there is data on the apparent consumption of wood products in the UK. A consistent dataset is available at the product level (i.e., sawnwood, wood panels and paper & paperboard) for 2002 onwards. The ten-year average of 2002-2011 was calculated for each product type and those values were used for the years 1990-2001. This dataset was used to assign the HWP output from the CARBINE model into either consumed domestically or exported.

---

<sup>34</sup> <http://www.fao.org/faostat/en/#data/FO>

<sup>35</sup> <https://www.forestresearch.gov.uk/tools-and-resources/statistics/statistics-by-topic/timber-statistics/uk-wood-production-and-trade-provisional-figures/>

### A 3.4.11 Methods for the Overseas Territories (OTs) and Crown Dependencies (CDs)

The UK LULUCF inventory includes direct GHG emissions from UK Crown Dependencies (CDs) and Overseas Territories (OTs) which have joined, or are likely to join, the UK's instruments of ratification to the UNFCCC. Currently, these are: Guernsey, Jersey, the Isle of Man, the Falkland Islands, the Cayman Islands, Bermuda, and Gibraltar.

A web search of statistical publications is undertaken for any updates in datasets for every inventory compilation cycle. This work builds on an MSc project to calculate LULUCF net emissions/removals for the OTs and CDs undertaken during 2007 (Ruddock 2007).

Gibraltar has a very small land area (6 km<sup>2</sup>) with no agricultural land. The only area of woodland (dense Mediterranean scrub) occurs within the Upper Rock Nature Reserve/park, and is not managed for production<sup>36</sup>. The whole land area of Gibraltar is categorised as Settlement remaining Settlement and has not undergone any land use change since 1970. It is therefore estimated that there are no net LULUCF emissions from this territory.

An assessment of flooded land was undertaken for the Overseas Territories and Crown Dependencies. No flooded land areas exceed the area threshold of 1 km<sup>2</sup> used for the UK, so the area of Flooded Land remaining Flooded Land has been included with the Inland Water area in the Wetlands remaining Wetlands category.

Peat organic soils occur in the Falkland Islands and Isle of Man but not in the other Overseas Territories and Crown Dependencies. The reporting of drainage and rewetting of organic soils on the Isle of Man uses the same methodology (e.g. peatland classification and EFs) for the UK given in **section A 3.4.7** above, with further details given in Evans et al. (2017). The organic soil area reported for the Isle of Man uses the British Geological Survey 1:50,000 superficial geology map, which employs a peat depth threshold of 1 m, and thus reports a small area (475 ha) all occurring in the lowlands, which is an underestimate of the true area (**Table A 3.4.29**). A Manx Wildlife Trust survey is currently underway to map peat extent >40 cm, which will be used to complement the area estimates provided below. Data on land use change on organic soils is currently unavailable for reporting in the inventory. Peatland restoration activities are likely to increase in the near future; however, Isle of Man are a few years away from reporting outcomes (Shaun Gelling Isle of Man Government Agriculture and Lands Directorate, pers. comm., 28/09/21).

**Table A 3.4.29 Assignment of peat areas (kha) to condition categories for the Isle of Man in 1990 and 2021.**

Crown Dependency	Isle of Man	
	All	All
Peat category	1990	2021
Forest	118	118
Cropland	41	41

<sup>36</sup> [https://www.gibraltar.gov.gi/new/sites/default/files/1/15/Upper\\_Rock\\_Nature\\_Reserve\\_Management\\_Action\\_Plan.pdf](https://www.gibraltar.gov.gi/new/sites/default/files/1/15/Upper_Rock_Nature_Reserve_Management_Action_Plan.pdf)

Crown Dependency	Isle of Man	
Peat category	All	All
Year	1990	2021
Drained Eroding Modified Bog (bare peat)	1	1
Undrained Eroding Modified Bog (bare peat)	0	0
Drained Modified Bog (Heather + Grass dominated)	0	0
Undrained Modified Bog (Heather + Grass dominated)	13	13
Extensive Grassland (combined bog + fen)	99	99
Intensive Grassland	204	204
Near Natural Bog	0	0
Near Natural Fen	0	0
Extracted Domestic	0	0
Extracted Industrial	0	0
Settlement	0	0
Rewetted Modified (Semi-natural) Bog	0	0
Rewetted Bog	0	0
Rewetted Fen	0	0
<b>Total</b>	<b>475</b>	<b>475</b>

Information on the distribution and emissions from peat condition classes in the Falkland Islands is incomplete, but is being addressed by ongoing scientific research (see Chapter 6). Estimates of emissions from peat extraction for domestic fuel use were included for the first time in this submission with the incorporation of a new data source (Falkland Islands 2016 Census report). Information from the Falkland household census (repeated every 5-6 years from 1991) on the number of households using peat as a fuel was combined with expert local knowledge on peat use per household to produce an activity data time series using interpolation between census values.

A small area of deforestation occurs in Guernsey, obtained from habitat surveys in 1999, 2010 and 2018. The change in forest cover is a result of the changed areas losing sufficient tree cover to be reclassified as dense scrub or parkland, rather than conversion to settlement land or agriculture, therefore changes in soil carbon stocks do not occur. Deforestation in the Cayman Islands arises from mangrove conversion to urban development (Jurn et al. 2018) and occurs on organic soils.

The UK has assessed the available information on wildfires in the OTs and CDs, and will repeat this procedure for future inventories. The procedure included reviewing available published government data on fire occurrence and contact with local experts for all CDs and OTs, which brought up no relevant information. We also conducted searches on global fire data portals (Global Forest Watch, Global Fire Emissions Database, and Global Wildfire Information System (GWIS)). All of these portals record zero occurrences of fires and zero burnt area for 2002-2019 for the Cayman Islands, Jersey, Guernsey and the Isle of Man.

The GWIS portal does record a total of 11 fires between 2002 and 2019 in the Falkland Islands with an estimated total area of 5,024 ha based on pixel size, although the total burnt area is recorded as zero.

Due to the lack of publicly available data in wildfires in the OTS and CDS we estimate the extent of biomass burning using geographical proxy burning rates. The *pro rata* area of grassland wildfires in the UK was used for grassland biomass burning in the Crown Dependencies, Cayman Islands and Falkland Islands. The estimated rate of grassland wildfire occurrence in the Falklands, using the geographical proxy, is 944 ha p.a., which has been assessed as a plausible annual area by local experts. The *pro rata* area of forest wildfires in the UK was used for forest biomass burning in the Crown Dependencies, and the pro rate for Cuba was used for the Cayman Islands. Bermuda fires statistics reported no wildfire area for either forest or grassland. There is no forest in the Falkland Islands so no wildfire occurrence there. The estimated rate of grassland wildfire occurrence in the Falklands, using the geographical proxy, is 944 ha p.a., which has been assessed as a plausible annual area by local experts.

Information on the area of each IPCC land category, dominant management practices, land use change, soil types and climate types were compiled for each OT/CD from statistics and personal communications from their government departments (**Table A 3.4.30**). This allowed Tier 1 level inventories to be constructed for the OT/CDs for all land use categories. The assumptions and factors used for the estimation of emissions are given in **Table A 3.4.31**. The estimates have high uncertainty and may not capture all relevant activities, but given the size of the territories any missing sources are likely to be small.

## Other Detailed Methodological Descriptions **A3**

**Table A 3.4.30 Information sources for estimating LULUCF emissions from the Overseas Territories and Crown Dependencies**

Territory	LULUCF category	Time period	Reference
<b>Isle of Man</b>	4A	1970-2011	Personal communication from Isle of Man Department of Agriculture, Fisheries and Forestry (Peter Williamson) FAO (2010) Global Forest Resources Assessment: Isle of Man
	4B, 4C, 4D	2002-2018	Isle of Man Agricultural and Horticultural Census: completed by all farmland occupiers on an annual basis Isle of Man Digest of Economic and Social Statistics
	4B, 4C	2012 - 2013	Isle of Man Digest of Economic and Social Statistics
	4B, 4C	2014	The Isle of Man in Numbers
	4E	1991-1994	Isle of Man Ecological Habitat Survey, Phase 1 Report (Sayle et al, 1995)
	4D	1990-present	Evans et al. 2017 and subsequent updates
<b>Guernsey</b>	4A	1990-2010	FAO Global Forest Resources Assessment 2010: Guernsey
	4A, 4B, 4C, 4D, 4E	1998/9, 2005, 2018	Guernsey Habitat Survey (1998, 2010, 2018), Sustainable Guernsey 2005, 2009; Guernsey Facts and Figures 2018
<b>Jersey</b>	4A	1990-2010	FAO Global Forest Resources Assessment 2010: Jersey
	4B	1990 - 2018	Jersey Agricultural Statistics
	4A, 4B, 4C, 4D, 4E	2006, 2008, 2012, 2015	Jersey In Figures 2006-present
<b>Falkland Islands</b>	4A	1990-2011	Department of Mineral Resources, personal communication FAO Global Forest Resources Assessment 2010: Falkland Islands
	4B, 4C	1991-present	Falkland Islands Agricultural Statistics
	4D	1991-present	Falkland Islands 2016 Census
	4E	1990-2005	Falkland Islands Environment and Planning Department, personal communication
	4E	1986 – 2001 with projections 2006 - 2016	Stanley Town Plan, Environmental Planning Dept, Falkland Islands Government.

## Other Detailed Methodological Descriptions **A3**

Territory	LULUCF category	Time period	Reference
Cayman Islands	4A, 4B, 4C, 4D, 4E	2013	Cayman Island Compendium of Statistics- Land Cover 2013; Agricultural Land Capability of the Cayman Islands (1996)
	4E	1965-2013	Jurn et al. (2018); Information provided by Cayman Islands Government to Aether for GHGI (2017)
Bermuda	4A, 4B, 4D, 4E	1989-present	Bermuda Biodiversity Study <sup>37</sup> , Bermuda Environmental Statistics Compendium

**Table A 3.4.31 Assumptions and EFs used in applying the Tier 1 methodology to the Overseas Territories and Crown Dependencies**

Land Use category	Sub-category	Isle of Man	Guernsey	Jersey	Falkland Islands	Cayman Islands	Bermuda
Soil C density, tC/ha	Mineral soil	95	95	95	87	35	47

<sup>37</sup> <https://environment.bm/country-study>

## Other Detailed Methodological Descriptions **A3**

Land Use category	Sub-category	Isle of Man	Guernsey	Jersey	Falkland Islands	Cayman Islands	Bermuda
<b>Forest land fluxes</b>	Living biomass, DOM, Mineral soils, Organic soils	Tier 1 temperate oceanic forest and temperate oceanic plantation EFs used. Area increased 1961-1990, but stable since. Gains and losses (thinning management) in living biomass are calculated, deadwood, litter and mineral soil CSC are assumed to be zero under Tier 1. Emissions from organic soil use Tier 2 EFs (not CARBINE).	Tier 1 temperate oceanic forest and temperate oceanic plantation EFs used. All forest is on mineral soil. Area increased 2000-present. Gains in living biomass are calculated, deadwood, litter and mineral soil CSC are assumed to be zero under Tier 1.	Assumed in equilibrium	No forest on Falklands	Tier 1 tropical dry forest and tropical dry mangrove EFs used. All forest is on mineral soil, all mangrove is on organic soil. The forest area is stable 1990-2005. Assumed that any gains in biomass are lost in the same year, keeping the carbon stock changes in balance. Deadwood, litter and mineral and mangrove soil CSC are assumed to be zero under Tier 1	Tier 1 tropical dry forest and tropical dry mangrove EFs used. All forest is on mineral soil, all mangrove is on organic soil. Assumed that any gains in biomass are lost in the same year, keeping the carbon stock changes in balance. Deadwood, litter and mineral and mangrove soil CSC are assumed to be zero under Tier 1
	Wildfires	Use proxy rate of burning in UK forests (0.030% p.a.). Tier 1 EFs for "All other temperate forests".	Use proxy rate of burning in UK forests (0.030% p.a.) Tier 1 EFs for "All other temperate forests".	Use proxy rate of burning in UK forests (0.030% p.a.) Tier 1 EFs for "All other temperate forests".	N/A	Use proxy rate of burning in Cuba forests (0.15% p.a.). Tier 1 EFs for "Primary tropical forest".	No reported wildfires



## Other Detailed Methodological Descriptions **A3**

Land Use category	Sub-category	Isle of Man	Guernsey	Jersey	Falkland Islands	Cayman Islands	Bermuda
<b>Crop remaining crop</b>	Living biomass	N/A. Only for perennial crops	Orchards only. 10 tC/ha	N/A. Only for perennial crops	N/A. Only for perennial crops	There is no land use data to distinguish the cropland within the man-modified area, so it is included with the settlement area.	Agricultural land is predominantly cropland and the small area of agricultural grassland (dairy/forage) has been included here. Assumed stable with no net emissions
	Dead organic matter	N/A	N/A	N/A	N/A		
	Mineral soils	No change in SOC	No change in SOC	No change in SOC	N/A		
	Organic soils	Emissions from organic soil use Tier 2 EFs	N/A	N/A	Default (-5 tC/ha)		

## Other Detailed Methodological Descriptions **A3**

Land Use category	Sub-category	Isle of Man	Guernsey	Jersey	Falkland Islands	Cayman Islands	Bermuda
<b>Land converted to Crop</b>	Living biomass	UK shrubby grass to crop values(5 tC/ha)	UK non-shrubby grass to crop value (2.2 tC/ha)	UK non-shrubby grass to crop value (2.2 tC/ha)	UK non-shrubby grassland to crop value (2.2 tC/ha)	There is no land use data to distinguish the cropland within the man-modified area, so it is included with the settlement area.	N/A
	Dead organic matter	N/A	N/A	N/A	N/A		
	Mineral soils	Conversion from natural grassland (-1.7347 tC/ha). Crop $F_{LU}=0.69$ , Crop $F_i=0.92$	Conversion from natural grassland (-0.95 tC/ha). Crop $F_{LU}=0.8$ , Crop $F_i=1$	Conversion from natural grassland (-0.95 tC/ha). Crop $F_{LU}=0.8$ , Crop $F_i=1$	N/A		
	Organic soils	Emissions from organic soil use Tier 2 EFs	N/A	N/A	Default (-5 tC/ha)		
	N <sub>2</sub> O emissions	Default (0.001817 t N <sub>2</sub> O/ha)	Default (0.000995 t N <sub>2</sub> O/ha)	Default (0.000995 t N <sub>2</sub> O/ha)	Default (0.012571 t N <sub>2</sub> O/ha)		

## Other Detailed Methodological Descriptions A3

Land Use category	Sub-category	Isle of Man	Guernsey	Jersey	Falkland Islands	Cayman Islands	Bermuda
<b>Grass remaining grass</b>	Living biomass	N/A	N/A	N/A	N/A	The grassland area is stable 1990-2005. Biomass, dead organic matter and soil CSC are assumed to be zero under Tier 1.	Included with Cropland
	Dead organic matter	N/A	N/A	N/A	N/A		
	Mineral soils	No change in SOC	No change in SOC	No change in SOC	N/A		
	Organic soils	Emissions from organic soil use Tier 2 EFs	N/A	N/A	Assume no soil C stock change		
	Wildfires	Use proxy rate of burning in UK grassland (0.093% p.a.). Tier 1 EFs for "Calluna heath (temperate)"	Use proxy rate of burning in UK grassland (0.093% p.a.). Tier 1 EFs for "Calluna heath (temperate)"	Use proxy rate of burning in UK grassland (0.093% p.a.). Tier 1 EFs for "Calluna heath (temperate)"	Use proxy rate of burning in UK grassland (0.093% p.a.). Tier 1 EFs for "Calluna heath (temperate)"	Use proxy rate of burning in UK grassland (0.093% p.a.). Tier 1 EFs for "Tropical/sub-tropical grassland (mid-late dry season burn)"	No reported wildfires
<b>Land converted to grass</b>	Living biomass	UK crop to non-shrubby grass values (-2.2 tC/ha)	UK settlement to non-shrubby grass value (0 tC/ha),  Forest to grass assume 120 t DM/ha in forest	Crop to Grassland: UK crop to non-shrubby grass value (-2.2 tC/ha)  Settlement to Grassland: assume increase from 0 in glasshouses (2.8 tC/ha)	Use crop to non-shrubby grassland value (-2.2 tC/ha)	Only dry forest is converted to grassland. Tier 1 tropical dry grassland and tropical dry forest EFs are used	N/A

## Other Detailed Methodological Descriptions **A3**

Land Use category	Sub-category	Isle of Man	Guernsey	Jersey	Falkland Islands	Cayman Islands	Bermuda
	Dead organic matter	N/A	Forest to grass assume 16 t DM/ha in forest	N/A	N/A	T1 tropical dry forest litter stocks, N/A for dead wood	N/A
	Mineral soils	Assume conversion from cropland (1.7347 tC/ha)	Assume conversion from settlement, assume same soil C as for cropland (0.95 tC/ha)	Cropland to Grassland: assume conversion from cropland (0.95 tC/ha)  Settlement to Grassland: assume no change	N/A	Fmg- tropical moderately degraded factor (0.97)	N/A
	Organic soils	Emissions from organic soil use Tier 2 EFs	N/A	N/A	Default (-0.25 tC/ha)	N/A	N/A
	N <sub>2</sub> O emissions	N/A	N/A	N/A	N/A	Tier 1 EFs with EF2 for tropical cropland/grassland	N/A
<b>Wetlands remaining Wetlands</b>	N/A	N/A	N/A	N/A	Peat extraction emissions use the T1 EFs for boreal peat managed for peat extraction from the 2013 IPCC Wetlands Supplement	The area of inland water is stable 1990-2005. The tropical shrubland values (IPCC 2006) are used for mangroves.	There is a small area of protected peat marsh reported in the Biodiversity Study (assumed stable). Areas of fresh/brackish ponds are very small and have been included in Other Land.
<b>Land converted to Wetlands</b>	Living biomass losses	N/A	N/A	N/A	N/A	T1 tropical dry forest EFs for conversion to inland water	N/A

## Other Detailed Methodological Descriptions **A3**

Land Use category	Sub-category	Isle of Man	Guernsey	Jersey	Falkland Islands	Cayman Islands	Bermuda
	Dead organic matter	N/A	N/A	N/A	N/A	Only dry forest is converted to flooded land. T1 tropical dry forest EFs for conversion to inland water	N/A
<b>Settlements remaining Settlements</b>	Living biomass, DOM, Mineral soils	N/A	N/A	N/A	N/A	It is assumed that any settlement area that existed before 1965 was on mineral soil. Any settlement area converted from mangrove post-1965 is assumed to be on organic soil.  T1 EF for cultivated organic soils (IPCC 2013)	All settlement is assumed to be on mineral soil. Assumed stable.
	Organic soils	N/A	N/A	N/A	N/A		

## Other Detailed Methodological Descriptions **A3**

Land Use category	Sub-category	Isle of Man	Guernsey	Jersey	Falkland Islands	Cayman Islands	Bermuda
<b>Land converted to Settlements</b>	Living biomass	UK values, shrubby grass to settlement (-7.2 tC/ha)	UK non-shrubby grass to settlement value (0 tC/ha)	Grassland to Settlement, UK non-shrubby grass to settlement value (0 tC/ha)  Cropland to Settlement: use cropland to settlement value (-2.2 tC/ha)	Use shrubby grass to settlement value (-7.2 tC/ha)	Tier 1 EFs for tropical dry mangrove forest and tropical mangrove shrubland converted to settlement	Conversion to settlement is assumed to occur on forest land and agricultural land at an overall rate of 9.2 ha per year (Bermuda Biodiversity Study value for previous 10 years). Assume 41.6% paved over and 20% soil C lost, 27.3% turf grass with 117% change in soil C, 31.1% wooded with no change in soil C. Assume Crop $F_{LU}=0.48$ (long-term cultivated on tropical moist soil)
	Dead organic matter	N/A	N/A	N/A	N/A		

## Other Detailed Methodological Descriptions **A3**

Land Use category	Sub-category	Isle of Man	Guernsey	Jersey	Falkland Islands	Cayman Islands	Bermuda
	Mineral soils	Default SOC = 95 tC/ha, assume conversion from grassland and all soil C lost (-4.75 tC/ha)	Default SOC = 95 tC/ha, assume 30% of land is paved over and the rest is turf grass (-1.14 tC/ha)	Default . SOC = 95 tC/ha,  Grassland to Settlement: assume 30% of land is paved over and the rest is turf grass (-1.14 tC/ha)  Cropland to Settlement: assume 30% of land is paved over and the rest is turf grass (0.95 tC/ha)	N/A	N/A	
	Organic soils	N/A	N/A	N/A	Default - assume cropland (-5 tC/ha)	T1 EF for cultivated organic soils (IPCC 2013)	N/A
	N <sub>2</sub> O emissions	Default (0.004976 t N <sub>2</sub> O/ha)	Default (0.00119 t N <sub>2</sub> O/ha)	Default (0.00119 t N <sub>2</sub> O/ha)	N/A	Tier 1 EFs with EF2 for tropical cropland/grassland (for Wetland to Settlement) and EF2 for tropical forest for F2S	
<b>Other land remaining other land</b>	Living biomass, DOM, Mineral soils, Organic soils	N/A	N/A	N/A	N/A	Area assumed to remain constant over time	Area assumed to remain constant over time

## Other Detailed Methodological Descriptions **A3**

Land Use category	Sub-category	Isle of Man	Guernsey	Jersey	Falkland Islands	Cayman Islands	Bermuda
<b>Land converted to other land</b>	Living biomass	N/A	Assume loss of grassland to standing water or cliff (-10 tC/ha)	Assumed loss of grassland to standing water (-2.8 t C/ha)	N/A	N/A	N/A
	Dead organic matter	N/A	N/A	N/A	N/A	N/A	N/A
	Mineral soils	N/A	Assume no change in soil stocks	N/A	N/A	N/A	N/A
	Organic soils	N/A	N/A	N/A	N/A	N/A	N/A
	N <sub>2</sub> O emissions	N/A	0	N/A	N/A	N/A	N/A
<b>Harvested wood products</b>		N/A	N/A	N/A	N/A	Instantaneous oxidation assumed for any timber from deforestation.	N/A



### **A 3.4.12 Uncertainty analysis of the LULUCF sector**

The purpose of carrying out uncertainty analysis within the LULUCF inventory is to quantify where the largest sources of errors lie, and to identify areas to be targeted in future work so as to reduce the uncertainties. In the 1990-2010 inventory report (2012) a sensitivity analysis of the whole of the existing inventory methodology was undertaken, applying uncertainty quantification more widely and rigorously to all model parameters and empirical conversion factors, in order to quantify the impact of those uncertainties on the inventory. This work was revisited in 2019/2020 (Henshall and Watterson 2020, not yet published), to re-assess the uncertainties and sensitivities associated with the forest land modelling and update the uncertainties for the non-forest parts of the LULUCF sector.

In 2010 parameterisation of the forest model was assessed as the second largest source of uncertainty. This has been addressed with the move to CARBINE, as 19 tree species are now modelled instead of the two used in previous submissions. Results from the National Forest Inventory (NFI) and small woods dataset will also provide additional information on carbon stocks in trees (e.g. Forestry Commission 2015<sup>38</sup>). The choice of soil carbon model and its parameters are also important because the time course of the flux following land use change may be quite different, depending on the equations used to represent this, and how carbon is distributed between fast- and slow-turnover pools. The choice of forest model is less important, largely because all the UK forest models are based on the same yield table data.

The updated uncertainty assessment of the Forest Land inventory and Harvested Wood Products (Henshall and Watterson 2020) (outputs derived from the CARBINE model) undertook a Monte Carlo analysis. The probability density functions (PDFs) assigned to the various CARBINE input parameters were based on information from the literature and expert judgement. A selection of 100 sets of input parameters were generated using Latin hypercube sampling, as this was considered to be the minimum number of model runs to get a reasonable estimate of the uncertainty considering the number of parameters adjusted.

The analysis of the carbon emissions/removals predicted by the model gave an uncertainty estimate at the 95% confidence interval of approximately 25% for both forest land and harvested wood products (rounded to the nearest 5%) in both the base year (1990) and the latest inventory year and 20% when both categories are considered in conjunction. This is smaller than what was assumed in the previous uncertainty analysis (around 40% uncertainty for those categories). While this may come in part from the improvement in the stratification of forest land obtained by the change of forest model, this is likely mostly a technical re-evaluation from a more up to date analysis of uncertainties range for the different parameters and the absence of characterisation of structural uncertainties in the model. In relative terms, carbon net emissions estimates for land converted to forest are assessed as considerably more uncertain (85% in the 1990 and 145% in 2020) than for forest remaining forest (20% in both 1990 and 2020). The activity data uncertainty for biomass, dead wood, litter and mineral soils is assessed as being 1%, but as 5% for forest organic soils.

---

<sup>38</sup> This survey is preliminary and the carbon stocks have been estimated using the same relationships and calculation parameters that underlie CARBINE; they are therefore not an independent validation of the LULUCF estimates.

In 2010 and the updated assessment the area undergoing land use change was assessed as being the single biggest uncertainty in the inventory. This uncertainty in the land use change areas has been addressed by the development of a new vector-based approach (see **Section A 3.4.3.1**), combining multiple sources of land use data and land cover data from administrative, survey and earth observation datasets. This has allowed better estimation of the uncertainties associated with the activity data and enabled the separate calculation of the uncertainties associated with carbon stock changes in non-forest Land remaining in the same land category and Land converted to another land category. The activity data uncertainty for Land remaining in the same category is relatively stable across the 1990-2021 time series, but more variable for Land converted to other land categories, due to the complex contribution of different data sources in the data assimilation across the inventory time period. Uncertainties for activities on organic soils were updated in the 1990-2021 submission as part of the revision of Tier 2 emission factors.

In general, compared to the previous inventory submission, the overall uncertainties did not change greatly for 1990 and the latest inventory year. A summary table of the combined uncertainties in the LULUCF sector is shown in **Table A 3.4.32**.

**Table A 3.4.32 Summary uncertainties for LULUCF sector activities**

LULUCF sub-category	Variable	CO <sub>2</sub>	CH <sub>4</sub>	N <sub>2</sub> O
4A1 Forest remaining Forest	Forest biomass and mineral soils	20% <sup>a</sup>		
4A1 Forest remaining Forest	Forest organic soils	21% <sup>a</sup>		
4A2 Land converted to Forest	Forest biomass and mineral soils	86-146 % <sup>a</sup>		
4A2 Land converted to Forest	Forest organic soils	86-146 % <sup>a</sup>		
4A Forest Land/4(I)	Forest fertilisation			34% <sup>a</sup>
4A Forest Land/4(II)	Mineral soil drainage			140% <sup>b</sup>
4A Forest Land/4(II)	Organic soil drainage		95% <sup>c</sup>	97% <sup>c</sup>
4A Forest Land/4(III)	N <sub>2</sub> O from land use change			135% <sup>b</sup>
4A Forest Land/4(V)	Biomass burning	54% <sup>d</sup>	54% <sup>d</sup>	54% <sup>d</sup>
4B1 Cropland remaining Cropland	LUC mineral soil carbon change	22-24% <sup>e</sup>		
4B1 Cropland remaining Cropland	LUC biomass carbon	36-37% <sup>e</sup>		
4B1 Cropland remaining Cropland	Cropland management (soils and biomass)	12% <sup>b</sup>		
4B1 Cropland remaining Cropland	Organic soils	62% <sup>c</sup>		
4B2 Forest Land converted to Cropland	LUC mineral soil carbon change	33-153% <sup>e</sup>		
4B2 Forest Land converted to Cropland	LUC biomass carbon	36-154% <sup>a</sup>		
4B2 Forest Land converted to Cropland	LUC DOM carbon stock change	36-154% <sup>a</sup>		
4B2 Forest Land converted to Cropland	Organic soils	60-161% <sup>c</sup>		
4B2 Grassland converted to Cropland	LUC mineral soil carbon change	18-24% <sup>e</sup>		
4B2 Grassland converted to Cropland	LUC biomass carbon	34-37% <sup>e</sup>		
4B2 Grassland converted to Cropland	Organic soils	62% <sup>c</sup>		
4B2 Settlements converted to Cropland	LUC mineral soil carbon change	186-196% <sup>e</sup>		

# Other Detailed Methodological Descriptions **A3**

LULUCF sub-category	Variable	CO <sub>2</sub>	CH <sub>4</sub>	N <sub>2</sub> O
4B2 Settlements converted to Cropland	LUC biomass carbon	188-197% <sup>e</sup>		
4B2 Settlements converted to Cropland	Organic soils	62% <sup>c</sup>		
4B Cropland/4(II)	Organic soil drainage- deep		75% <sup>c</sup>	61% <sup>c</sup>
4B Cropland/4(II)	Organic soil drainage- wasted		92% <sup>c</sup>	80% <sup>c</sup>
4B Cropland/4(III)	N <sub>2</sub> O from land use change			36% <sup>a</sup>
4B Cropland/4(V)	Biomass burning (wildfires and controlled burning after deforestation)	54% <sup>d</sup>	54% <sup>d</sup>	54% <sup>d</sup>
4C1 Grassland remaining Grassland	LUC mineral soil carbon change	27-30% <sup>e</sup>		
4C1 Grassland remaining Grassland	LUC biomass carbon	39-42% <sup>e</sup>		
4C1 Grassland remaining Grassland	Grassland management (biomass)	13% <sup>b</sup>		
4C1 Grassland remaining Grassland	Organic soils	31-32% <sup>c</sup>		
4C2 Forest Land converted to Grassland	LUC mineral soil carbon change	42-156% <sup>e</sup>		
4C2 Forest Land converted to Grassland	LUC biomass carbon	36-155% <sup>a</sup>		
4C2 Forest Land converted to Grassland	LUC DOM carbon stock change	36-155% <sup>a</sup>		
4C2 Forest Land converted to Grassland	Organic soils	31-32% <sup>c</sup>		
4C2 Cropland converted to Grassland	LUC mineral soil carbon change	21% <sup>e</sup>		
4C2 Cropland converted to Grassland	LUC biomass carbon	35% <sup>e</sup>		
4C2 Cropland converted to Grassland	Organic soils	31-32% <sup>c</sup>		
4C2 Settlements converted to Grassland	LUC mineral soil carbon change	135-142% <sup>e</sup>		
4C2 Settlements converted to Grassland	LUC biomass carbon	138-145% <sup>e</sup>		
4C2 Settlements converted to Grassland	Organic soils	31-32% <sup>c</sup>		
4C Grassland/4(II)	Organic soil drainage		34-36% <sup>c</sup>	46% <sup>c</sup>
4C Grassland/4(III)	N <sub>2</sub> O from land use change			135% <sup>b</sup>
4C Grassland/4(V)	Biomass burning (wildfires and controlled burning after deforestation)	54% <sup>d</sup>	54% <sup>d</sup>	54% <sup>d</sup>
4D Wetlands	Peat extraction offsite emissions	32% <sup>a</sup>		
4D Wetlands	Organic soils (extraction and rewetting)	43-44% <sup>c</sup>		
4D Wetlands/4(II)	Organic soil drainage		47-50% <sup>c</sup>	118-121% <sup>c</sup>
4D Wetlands	Flooded land biomass carbon	75% <sup>b</sup>		
4D2 Forest Land converted to Other wetlands	LUC biomass and DOM loss after rewetting	36-155% <sup>a</sup>		
4D Wetlands/4(V)	Biomass burning (controlled burning after deforestation)	54% <sup>d</sup>	54% <sup>d</sup>	54% <sup>d</sup>
4E1 Settlements remaining Settlements	LUC mineral soil carbon change	67-73% <sup>e</sup>		
4E1 Settlements remaining Settlements	LUC biomass carbon	72-79% <sup>e</sup>		
4E1 Settlements remaining Settlements	Organic soils	183% <sup>c</sup>		

LULUCF sub-category	Variable	CO <sub>2</sub>	CH <sub>4</sub>	N <sub>2</sub> O
4E2 Forest Land converted to Settlements	LUC mineral soil carbon change	32-150% <sup>e</sup>		
4E2 Forest Land converted to Settlements	LUC biomass and DOM carbon stock change	36-151% <sup>a</sup>		
4E2 Forest Land converted to Settlements	Organic soils	183% <sup>c</sup>		
4E2 Cropland converted to Settlements	LUC mineral soil carbon change	87-119% <sup>e</sup>		
4E2 Cropland converted to Settlements	LUC biomass carbon	91-121% <sup>e</sup>		
4E2 Cropland converted to Settlements	Organic soils	183% <sup>c</sup>		
4E2 Grassland converted to Settlements	LUC mineral soil carbon change	70-129% <sup>e</sup>		
4E2 Grassland converted to Settlements	LUC biomass carbon	76-132% <sup>e</sup>		
4E2 Grassland converted to Settlements	Organic soils	183% <sup>c</sup>		
4E Settlements/4(II)	Organic soil drainage		75% <sup>c</sup>	158% <sup>c</sup>
4E Settlements/4(III)	N <sub>2</sub> O from land use change			135% <sup>b</sup>
4E Settlements/4(V)	Biomass burning (wildfires and controlled burning after deforestation)	54% <sup>d</sup>	54% <sup>d</sup>	54% <sup>d</sup>
4G HWP	Harvested wood products	15-19% <sup>a</sup>		
4	Indirect N <sub>2</sub> O (atmospheric deposition)			240% <sup>b</sup>
4	Indirect N <sub>2</sub> O (leaching)			163% <sup>b</sup>

<sup>a</sup> Updated uncertainty assessment (Henshall and Watterson, 2020); <sup>b</sup> IPCC default; <sup>c</sup> Analysis of uncertainties for the reporting of drainage and rewetting of peatlands recommended by Evans et al. 2017 (see **Section A 3.4.7.3**) and revised in 2022; <sup>d</sup> Uncertainty assessment 2012, <sup>e</sup> Uncertainty assessment 2020.

## A 3.5 WASTE (CRF SECTOR 5)

### A 3.5.1 Solid Waste Disposal on Land (5A)

#### A 3.5.1.1 Input data

Because waste sent to landfill is now evaluated using individual waste consignments by EWC code, there is no need to make assumptions regarding waste composition, other than for two waste categories. These EWC codes are 19.12.12 (residues from waste sorting) and 20.03.01 (mixed municipal waste). Wastes with these codes were allocated in accordance with the findings of a survey carried out on behalf of Defra (Resource Futures, 2012), as set out in **Table A 3.5.1**. In absence of more up to date information this waste consumption data is considered to be representative of UK national circumstances. Data on DOC, DOCf and material compositions are provided in **Table A 3.5.2**.

The model allocates waste to two types of landfill – old, closed sites which last received waste in 1979, and modern engineered landfills that came into operation from 1980. Only these latter sites have gas management systems. The old closed sites have no gas control.

The quantities of waste sent to landfill are shown in **Table A 3.5.3**. The amounts of methane generated, recovered, used for power generation, flared, oxidised and emitted to the atmosphere are shown in **Table A 3.5.4**.

**Table A 3.5.1 Composition of waste sorting residues and mixed municipal waste**

<b>Material</b>	<b>19.12.12 (residues from waste sorting)</b>	<b>20.03.01 (mixed municipal waste)</b>
Paper	10.3%	10.6%
Card	9.1%	7.7%
Plastic film	9.4%	8.4%
Dense plastics	13.2%	9.6%
Sanitary waste	1.3%	3.1%
Wood	10.0%	5.3%
Textiles and shoes	5.9%	5.6%
Glass	1.3%	3.0%
Food waste	8.2%	21.3%
Garden waste	1.8%	3.5%
Other organic	1.3%	2.1%
Metals	3.2%	3.7%
WEEE	1.4%	1.5%
Haz waste and batteries	1.1%	0.9%
Carpet, underlay & furniture	7.0%	5.0%
Other combustibles	2.7%	1.4%
Bricks, plaster and soil	7.9%	4.1%
Other non-combustible	1.7%	1.5%
Fines <10mm	3.3%	1.8%
<b>Total</b>	<b>100%</b>	<b>100%</b>

# Other Detailed Methodological Descriptions **A3**

**Table A 3.5.2 DOC, DOC<sub>f</sub> and composition of waste materials**

Component	Lignin biodegradability DOC <sub>f</sub>	Non-lignin biodegradability DOC <sub>f</sub>	Moisture, %fresh matter	Lignin, % dm	Hemicellulose, %dm	Cellulose, %dm	Starch, %dm	Sugar, % dm	Fat, %dm	Proteins, %dm	Fibre, %dm	Readily soluble, %dm	Other (inert), % dm
<b>Carbon contents (DOC)</b>			<b>0%</b>	<b>65.1%</b>	<b>44.6%</b>	<b>40.0%</b>	<b>44.4%</b>	<b>42.1%</b>	<b>76.0%</b>	<b>40.0%</b>	<b>45.0%</b>	<b>45.0%</b>	<b>0.0%</b>
Paper	5%	65%	15%	15%	9%	61%							15.00%
Card	5%	65%	20%	15%	9%	61%							15.00%
Nappies	5%	65%	65%			47%							52.70%
Textiles and footwear	5%	65%	20%		15%	15%							69.68%
Miscellaneous combustible	5%	65%	20%		25%	25%							50.00%
Wood	5%	65%	17%	26%	12%	42%							21.00%
Food	15%	70%	70%	6%	4%	27%	13%	7%	14%	15%	14%	0%	0.00%
Garden	10%	65%	55%	20%	16%	20%			2%			26%	17.10%
Soil and other organic	5%	65%	30%		1%	1%							98.60%
Furniture	5%	65%	12%	1%	10%	11%	0%	0%	0%	0%	0%	0%	77.25%
Mattresses	5%	65%	20%		15%	15%							69.68%
Non-inert Fines		50%	40%		25%	25%							50.00%
Inert													100.00%
Commercial	5%	65%	37%		8%	76%							16.00%

## Other Detailed Methodological Descriptions **A3**

Component	Lignin biodegradability DOC <sub>f</sub>	Non-lignin biodegradability DOC <sub>f</sub>	Moisture, %fresh matter	Lignin, % dm	Hemicellulose, %dm	Cellulose, %dm	Starch, %dm	Sugar, % dm	Fat, %dm	Proteins, %dm	Fibre, %dm	Readily soluble, %dm	Other (inert), % dm
Paper and Card	5%	65%	15%	15%	9%	61%							15.00%
General industrial waste	5%	65%	37%		8%	76%							16.00%
Food and Abattoir	15%	70%	70%	5%	11%	11%	36%	7%	6%	18%			6.00%
Food effluent	15%	70%	65%		55%	7%							37.40%
Construction and demolition	5%	65%	30%		9%	9%							83.00%
Miscellaneous process waste	5%	65%	20%		10%	10%							80.00%
Other waste	5%	65%	20%		25%	25%							50.00%
Sewage sludge	5%	65%	70%		14%	14%							72.00%
Textiles / Carpet and Underlay	5%	65%	20%	0%	15%	15%	0%	0%	0%	0%			69.68%
Sanitary	5%	65%	65%	0%	0%	47%	0%	0%	0%	0%			52.70%
Other	5%	65%											100.00%

**Table A 3.5.3 Amount of waste landfilled (Mt) (1945 to 2021)**

Year	England	Scotland	Wales	Northern Ireland	Total	Year	England	Scotland	Wales	Northern Ireland	Total
1945	70.9	9.0	4.6	2.3	86.9						
1946	71.2	9.0	4.6	2.4	87.2	1984	77.2	8.5	4.6	2.6	92.8
1947	71.5	9.0	4.6	2.4	87.4	1985	77.2	8.4	4.6	2.6	92.8

## Other Detailed Methodological Descriptions **A3**

Year	England	Scotland	Wales	Northern Ireland	Total	Year	England	Scotland	Wales	Northern Ireland	Total
1948	71.7	9.0	4.6	2.4	87.7	1986	77.3	8.4	4.6	2.6	92.9
1949	72.3	9.0	4.6	2.4	88.4	1987	77.3	8.3	4.6	2.6	92.9
1950	72.9	9.1	4.6	2.4	89.1	1988	77.4	8.3	4.6	2.6	92.9
1951	73.6	9.1	4.6	2.5	89.8	1989	77.4	8.3	4.6	2.6	92.9
1952	74.2	9.1	4.7	2.5	90.5	1990	77.7	8.3	4.7	2.6	93.3
1953	74.2	9.1	4.7	2.5	90.4	1991	77.7	11.3	4.7	2.6	96.3
1954	74.2	9.0	4.6	2.4	90.3	1992	77.7	12.2	4.7	2.6	97.2
1955	74.2	9.0	4.6	2.4	90.3	1993	77.6	14.0	4.6	2.6	98.8
1956	75.7	9.1	4.7	2.5	92.0	1994	77.6	15.9	4.6	2.6	100.7
1957	77.2	9.2	4.8	2.5	93.7	1995	81.8	15.0	4.9	2.8	104.5
1958	78.6	9.3	4.8	2.6	95.4	1996	80.7	15.0	4.8	2.8	103.3
1959	80.1	9.5	4.9	2.6	97.1	1997	81.1	14.0	4.8	2.8	102.7
1960	81.5	9.6	5.0	2.6	98.8	1998	75.0	11.9	4.5	2.6	93.9
1961	81.1	9.7	4.9	2.7	98.4	1999	69.3	10.9	4.1	2.4	86.6
1962	80.9	9.6	4.9	2.7	98.0	2000	67.4	11.2	4.0	2.3	84.9
1963	84.5	10.0	5.1	2.8	102.4	2001	71.4	8.9	4.2	2.4	86.9
1964	84.6	9.9	5.1	2.8	102.4	2002	66.8	8.2	3.9	2.3	81.3
1965	85.7	10.0	5.1	2.8	103.6	2003	65.4	7.9	3.8	2.2	79.4
1966	85.3	9.9	5.1	2.8	103.2	2004	64.9	7.8	3.8	2.2	78.7



## Other Detailed Methodological Descriptions **A3**

Year	England	Scotland	Wales	Northern Ireland	Total	Year	England	Scotland	Wales	Northern Ireland	Total
1967	85.0	9.8	5.1	2.8	102.7	2005	60.0	7.1	3.5	2.0	72.6
1968	84.8	9.7	5.1	2.8	102.4	2006	64.9	7.1	4.0	2.0	78.1
1969	84.0	9.6	5.0	2.8	101.4	2007	60.7	7.4	3.2	1.9	73.2
1970	83.8	9.5	5.0	2.8	101.0	2008	53.9	6.1	2.9	1.6	64.5
1971	82.8	9.3	4.9	2.7	99.8	2009	44.0	4.7	2.5	1.1	52.3
1972	81.8	9.2	4.8	2.7	98.5	2010	43.6	4.6	2.3	1.0	51.4
1973	81.3	9.1	4.8	2.7	97.9	2011	44.7	4.7	2.2	1.0	52.5
1974	79.9	9.0	4.8	2.6	96.3	2012	41.8	4.5	2.2	1.1	49.6
1975	80.1	9.0	4.8	2.6	96.5	2013	41.1	4.1	2.2	1.1	48.4
1976	78.8	8.8	4.7	2.6	94.9	2014	41.3	4.1	1.5	1.3	48.2
1977	78.4	8.8	4.7	2.6	94.5	2015	43.9	4.2	1.3	1.6	51.0
1978	78.8	8.8	4.7	2.6	95.0	2016	44.7	3.7	2.0	1.9	52.3
1979	78.7	8.8	4.7	2.6	94.7	2017	45.4	3.8	1.8	1.7	52.7
1980	78.6	8.7	4.7	2.6	94.6	2018	44.1	3.7	1.4	1.5	50.7
1981	77.0	8.5	4.6	2.5	92.7	2019	45.9	3.0	1.1	1.5	51.4
1982	77.1	8.5	4.6	2.5	92.7	2020	39.8	2.6	1.0	1.4	44.8
1983	77.1	8.5	4.6	2.6	92.8	2021	43.2	3.4	1.1	1.6	49.3

### A 3.5.1.2 Methane emissions

The right-most column of **Table A 3.5.4** shows the current estimate of methane emitted from UK landfills, according to the approach outlined in **Chapter 7**, taking account of recovery and oxidation.

## Other Detailed Methodological Descriptions **A3**

**Table A 3.5.4 Amount of waste landfilled and methane generated, captured, utilised, flared, oxidised and emitted**

Year	Waste Landfilled Mt	Methane generated Kt	Methane captured kt	Methane captured %	Methane used for power generation kt	Methane used for power generation %	Methane flared kt	Methane flared %	Residual methane oxidised kt	Residual methane oxidised %	Methane emitted kt	Methane emitted %
1990	93.25	2,709	33	1%	33	1%	0	0%	268	10%	2408	89%
1991	96.32	2,752	50	2%	50	2%	0	0%	270	10%	2432	88%
1992	97.18	2,797	90	3%	90	3%	0	0%	271	10%	2436	87%
1993	98.85	2,837	107	4%	107	4%	0	0%	273	10%	2457	87%
1994	100.75	2,878	124	4%	124	4%	0	0%	275	10%	2479	86%
1995	104.50	2,939	135	5%	135	5%	0	0%	280	10%	2524	86%
1996	103.26	2,983	170	6%	170	6%	0	0%	281	9%	2532	85%
1997	102.70	3,022	218	7%	218	7%	0	0%	280	9%	2524	84%
1998	93.85	3,038	278	9%	278	9%	0	0%	276	9%	2484	82%
1999	86.63	3,032	394	13%	394	13%	0	0%	264	9%	2374	78%
2000	84.85	3,028	500	17%	500	17%	0	0%	253	8%	2275	75%
2001	86.92	3,040	566	19%	566	19%	0	0%	247	8%	2227	73%
2002	81.28	3,021	599	20%	598	20%	1	0%	242	8%	2180	72%
2003	79.38	2,981	723	24%	723	24%	0	0%	226	8%	2032	68%
2004	78.71	2,937	874	30%	874	30%	0	0%	206	7%	1857	63%
2005	72.59	2,870	926	32%	926	32%	0	0%	194	7%	1750	61%
2006	74.83	2,753	950	35%	944	34%	6	0%	180	7%	1622	59%
2007	73.21	2,645	989	37%	987	37%	2	0%	166	6%	1490	56%
2008	64.51	2,528	1065	42%	980	39%	85	3%	146	6%	1316	52%
2009	52.33	2,400	1112	46%	1015	42%	97	4%	127	5%	1159	48%
2010	51.38	2,278	1200	53%	1066	47%	134	6%	108	5%	971	43%

## Other Detailed Methodological Descriptions **A3**

Year	Waste Landfilled Mt	Methane generated Kt	Methane captured kt	Methane captured %	Methane used for power generation kt	Methane used for power generation %	Methane flared kt	Methane flared %	Residual methane oxidised kt	Residual methane oxidised %	Methane emitted kt	Methane emitted %
2011	52.54	2,159	1178	55%	1075	50%	103	5%	98	5%	883	41%
2012	49.55	2,041	1124	55%	1042	51%	82	4%	92	4%	825	40%
2013	48.43	1,929	1144	59%	1035	54%	109	6%	78	4%	706	37%
2014	48.15	1,820	1142	63%	1007	55%	136	7%	68	4%	610	34%
2015	50.98	1,716	1065	62%	974	57%	90	5%	65	4%	587	34%
2016	52.31	1,627	1007	62%	941	58%	67	4%	62	4%	558	34%
2017	52.75	1,544	916	59%	857	56%	59	4%	63	4%	565	37%
2018	50.70	1,468	837	57%	783	53%	53	4%	63	4%	568	39%
2019	51.45	1,396	773	55%	725	52%	49	3%	62	4%	560	40%
2020	44.84	1,325	757	57%	699	53%	58	4%	57	4%	511	39%
2021	49.31	1272	732	58%	662	52%	70	5%	54	4%	486	38%

### Notes

- a. Methane generated is based on the MELMod model.
- b. Methane captured is the sum of methane used for power generation and methane flared.
- c. Methane used for power generation is calculated from official figures on landfill gas electricity generation (Digest of UK Energy Statistics (BEIS, 2016), in GWh/year, assuming a net calorific value for methane of 50 GJ/tonnes and a conversion efficiency between methane use and electricity export of 30% rising to 36%, which includes parasitic losses and on-site use of electricity, e.g. for gas blowers, leachate treatment and site offices.
- d. Methane flared is calculated from site-specific data provided by the Environment Agency at regulated sites for 2009 to 2013, from SEPA for 2013, from a study carried out during 2014, and from site-specific data provided voluntarily by site operators.
- e. Methane oxidised is based on the IPCC default oxidation factor of 10%, applied to methane remaining after subtraction of the amount captured.
- f. Methane emitted = (methane generated – methane captured) x (1-oxidation factor).

## Other Detailed Methodological Descriptions **A3**

### A 3.5.1.3 Overseas Territories and Crown Dependencies

For the overseas territories and crown dependencies, the IPCC landfill model is used. Where available, country-specific waste generation and composition data have been applied and appropriate defaults chosen e.g. taking into account climatic variation. There are no landfill emissions for Gibraltar as waste is exported. **Table A 3.5.5** below gives the parameters used.

**Table A 3.5.5 Parameters used in landfill emission estimates for overseas territories and crown dependencies**

Region	Methodology	Activity data	MCF	DOC	k value
Guernsey	IPCC Landfill Model	2005 onwards: total MSW to landfill data and percentage that is plastics, other inert. Prior to 2005: flat-lined 2005 data	IPCC default values; waste management type is unmanaged, deep (results from expert consultation, 2014)	IPCC default values	Region: Europe: Western Climate: Wet Temperate
Jersey	N/A, all MSW is incinerated for energy from waste	N/A	N/A	N/A	N/A
Gibraltar	N/A, all MSW used to be incinerated, now all waste is exported to be landfilled in Spain.	N/A	N/A	N/A	N/A
Isle of Man	IPCC Landfill Model	2004 onwards: all waste incinerated for energy from waste. Prior to 2004: population and IPCC default waste per capita for Western Europe	IPCC default values; waste management type is 50% unmanaged, deep and 50% managed, semi-aerobic (results from expert consultation, 2014)	IPCC default values	Region: Europe: Western Climate: Wet Temperate
Bermuda	IPCC Landfill Model	Total MSW to landfill (Environmental Statistics Compendium)	IPCC default values; no information on management system so assume unmanaged deep	IPCC default values	Region: Caribbean Climate: Moist and wet tropical

## Other Detailed Methodological Descriptions **A3**

Region	Methodology	Activity data	MCF	DOC	k value
Cayman Islands	IPCC Landfill Model	2000 onwards: Total MSW to landfill (Department of Environmental Health). Prior to 2000: flat-lined 2000 data	IPCC default values; landfill sites are lined and managed to some degree, but with limited information, "Uncategorised" considered appropriate	IPCC default values	Region: Caribbean Climate: Moist and wet tropical
Falkland Islands	IPCC Landfill Model	1998: Halcrow Report. Other years: flat-lined after advice in personal communication from environmental officer	IPCC default values; waste management type is unmanaged, shallow (results from expert consultation, 2014)	IPCC default values	Region: America: South Climate: Wet Temperate

**A 3.5.2 Biological Treatment of Solid Waste (5B)**

The annual amount of waste treated in the composting process (fresh weight; fw) are reported in **Table A 3.5.6**. Fresh weight can be converted to dry mass by using the IPCC default a factor of 0.4 dry matter/fresh weight.

**Table A 3.5.6 Activity Data: Inputs in the composting process**

Year	Composting (Non-household) (Mg fw)	Composting (Household) (Mg fw)	MBT – Composting (Mg fw)
1990	-	181,322	-
1991	229,036	181,756	-
1992	458,072	182,146	-
1993	687,108	182,638	-
1994	916,144	183,213	-
1995	1,145,181	183,654	-
1996	1,374,217	184,132	-
1997	1,603,253	184,643	-
1998	1,832,289	185,364	-
1999	2,061,325	185,979	-
2000	2,290,361	186,676	-
2001	2,519,397	187,441	67,882
2002	2,748,433	187,373	62,537
2003	2,977,469	187,300	57,192
2004	3,206,506	238,235	37,179
2005	3,435,542	289,058	88,917
2006	3,664,578	339,909	110,618
2007	3,893,614	390,804	542,678
2008	3,720,016	441,622	629,269
2009	4,655,911	492,393	438,011
2010	4,802,584	496,077	1,282,060
2011	4,882,131	500,008	1,898,570

Year	Composting (Non-household) (Mg fw)	Composting (Household) (Mg fw)	MBT – Composting (Mg fw)
2012	5,322,707	503,005	1,719,118
2013	5,423,868	505,833	2,138,366
2014	6,064,095	509,350	2,439,341
2015	5,820,954	513,040	2,740,317
2016	6,088,865	517,007	3,041,292
2017	6,175,704	519,898	3,342,268
2018	5,692,141	522,778	3,643,244
2019	5,458,284	525,570	3,944,219
2020	4,912,301	527,590	4,245,195
2021	5,272,205	530,215	4,546,171

**Table A 3.5.7 Activity Data: Inputs in the anaerobic digestion process**

Year	Anaerobic digestion – non-agricultural residue (Mg)	Anaerobic digestion – MBT (Mg)
1990	5,354	0
1991	5,354	0
1992	5,354	0
1993	5,354	0
1994	9,111	0
1995	9,111	0
1996	9,111	0
1997	9,737	0
1998	9,737	0
1999	9,737	0
2000	9,737	0
2001	9,737	16,970
2002	59,830	15,634

Year	Anaerobic digestion – non-agricultural residue (Mg)	Anaerobic digestion – MBT (Mg)
2003	59,830	14,298
2004	91,189	37,179
2005	195,586	17,783
2006	212,480	27,655
2007	232,517	40,847
2008	260,388	66,664
2009	383,743	365,570
2010	767,767	72,262
2011	1,356,489	104,815
2012	1,905,206	795,961
2013	3,065,808	600,692
2014	4,751,258	703,455
2015	5,899,964	806,218
2016	7,384,945	908,982
2017	7,854,720	1,011,745
2018	7,573,392	1,114,508
2019	7,076,346	1,217,272
2020	7,658,737	1,320,035
2021	7,983,765	1,422,799

**A 3.5.3 Waste Incineration (5C)**

**Table A 3.5.8 Activity Data: UK Waste Incineration**

Year	Municipal Waste Incineration <sup>a</sup> (Mt)	Clinical Waste Incineration (Mt)	Chemical Waste Incineration (Mt)	Sewage Sludge Incineration (Mt)
1990	2.093	0.350	0.290	0.075
1991	2.069	0.350	0.290	0.069
1992	1.945	0.330	0.290	0.072



Year	Municipal Waste Incineration <sup>a</sup> (Mt)	Clinical Waste Incineration (Mt)	Chemical Waste Incineration (Mt)	Sewage Sludge Incineration (Mt)
1993	1.677	0.310	0.290	0.084
1994	1.148	0.290	0.289	0.072
1995	0.996	0.270	0.289	0.082
1996	1.062	0.250	0.288	0.088
1997	-	0.230	0.287	0.081
1998	-	0.236	0.287	0.185
1999	-	0.242	0.286	0.189
2000	-	0.248	0.285	0.194
2001	-	0.254	0.285	0.198
2002	-	0.260	0.284	0.203
2003	-	0.221	0.263	0.207
2004	-	0.182	0.241	0.212
2005	-	0.143	0.220	0.216
2006	-	0.105	0.191	0.220
2007	-	0.111	0.184	0.215
2008	-	0.115	0.159	0.192
2009	-	0.121	0.145	0.199
2010	-	0.114	0.151	0.231
2011	-	0.107	0.148	0.224
2012	-	0.107	0.146	0.209
2013	-	0.101	0.167	0.200
2014	-	0.103	0.171	0.174
2015	-	0.092	0.165	0.169
2016	-	0.093	0.164	0.148
2017	-	0.092	0.153	0.133
2018	-	0.092	0.134	0.112

Year	Municipal Waste Incineration <sup>a</sup> (Mt)	Clinical Waste Incineration (Mt)	Chemical Waste Incineration (Mt)	Sewage Sludge Incineration (Mt)
2019	-	0.096	0.141	0.088
2020	-	0.092	0.146	0.071
2021	-	0.080	0.128	0.071

a Note that all MSW incinerators were either closed or converted to extract power by 1997. In the latter case they were then considered to be power generation and so emissions were reported in 1A1a.

**Table A 3.5.9 Emissions Data: UK Waste Incineration (kt)**

Pollutant	Year	Chemical Waste Incineration	Accidental Fires	MSW Incineration	Clinical Waste Incineration	Sewage Sludge Incineration	Small-scale waste burning	Total
CO <sub>2</sub>	1990	444	NE	165	444	NA	93	1,448
	1995	442	NE	100	442	NA	87	1,132
	2000	404	NE	NO	404	NA	86	708
	2005	339	NE	NO	339	NA	80	545
	2010	188	NE	NO	188	NA	72	360
	2015	164	NE	NO	164	NA	68	313
	2017	176	NE	NO	176	NA	69	327
	2018	159	NE	NO	159	NA	70	310
	2019	158	NE	NO	158	NA	70	312
	2020	167	NE	NO	167	NA	68	316
	2021	202	NE	NO	202	NA	68	340
CH <sub>4</sub>	1990	0.144	1.009	4.179	0.144	0.029	2.185	7.555
	1995	0.143	0.984	2.205	0.143	0.032	2.002	5.374
	2000	0.103	0.772	NO	0.103	0.076	1.945	2.902
	2005	0.068	0.708	NO	0.068	0.084	1.819	2.683
	2010	0.030	0.366	NO	0.030	0.090	1.756	2.244
	2015	0.027	0.279	NO	0.027	0.066	1.758	2.132
	2017	0.029	0.277	NO	0.029	0.052	1.776	2.136
	2018	0.027	0.271	NO	0.027	0.044	1.798	2.142
	2019	0.027	0.258	NO	0.027	0.034	1.807	2.128

## Other Detailed Methodological Descriptions **A3**

Pollutant	Year	Chemical Waste Incineration	Accidental Fires	MSW Incineration	Clinical Waste Incineration	Sewage Sludge Incineration	Small-scale waste burning	Total
	2020	0.027	0.238	NO	0.027	0.028	1.794	2.089
	2021	0.029	0.235	NO	0.029	0.028	1.803	2.097
N <sub>2</sub> O	1990	0.029	NE	0.056	0.029	0.074	0.061	0.230
	1995	0.029	NE	0.029	0.029	0.081	0.055	0.202
	2000	0.029	NE	NO	0.029	0.192	0.053	0.281
	2005	0.022	NE	NO	0.022	0.214	0.048	0.289
	2010	0.016	NE	NO	0.016	0.229	0.047	0.295
	2015	0.017	NE	NO	0.017	0.167	0.047	0.233
	2017	0.017	NE	NO	0.017	0.131	0.047	0.199
	2018	0.014	NE	NO	0.014	0.110	0.048	0.175
	2019	0.015	NE	NO	0.015	0.087	0.048	0.153
	2020	0.015	NE	NO	0.015	0.070	0.048	0.136
	2021	0.015	NE	NO	0.015	0.070	0.048	0.135

Note that all MSW incinerators were either closed or converted to extract power by 1997. In the latter case they were then considered to be power generation and so emissions were reported in 1A1a. NE and NO are notation keys as defined in FCCC Decision 24/CP.19 paragraph 37.

**A 3.5.4 Wastewater Handling (5D)**

**A 3.5.4.1 5D1 Domestic and Commercial Wastewater Handling and Sludge Disposal**

**Table A 3.5.10 UK Domestic and Commercial Wastewater Treatment (5D1) Activity Data**

Process stage	Process type	unit	1990	1995	2000	2005	2010	2015	2018	2019	2020	2021
Total Sludge		kt tds	1344	1393	1483	1768	1655	1597	1688	1687	1670	1713
Population Equivalent		million	69.1	70.1	71.2	71.4	70.3	73.0	73.8	74.7	71.6	71.1
Additional Treatment	Digested	kt tds	491.8	531.0	517.5	903.8	954.3	759.6	659.5	598.0	600.7	579.0
	Advanced Digested	kt tds	0.0	0.0	57.9	290.3	358.2	515.1	711.9	833.5	857.3	893.3
	Composted	kt tds	0.0	0.0	9.2	13.5	23.8	6.5	1.7	4.9	0.7	0.6
Disposal route	Land	kt tds	595.8	670.4	768.6	1384.9	1372.4	1454.9	1553.8	1569.9	1580.4	1616.0
	Landfill	kt tds	120.8	113.8	83.0	130.9	33.7	0.4	0.4	0.4	0.4	0.6
	Incineration	kt tds	68.8	81.7	235.5	252.6	249.3	141.8	133.7	116.9	89.0	96.1
	Sea	kt tds	558.3	527.5	395.7	0.0	0.0	0.0	0.0	0.0	0.0	0.0

Where tds is total dissolvable solids; this is assumed to be comparable to Biochemical Oxygen Demand (BOD)

**Table A 3.5.11 UK Domestic and Commercial Waste Water Treatment (5D1) Implied Emission Factors**

Process stage	Process type	unit	1990	1995	2000	2005	2010	2015	2018	2019	2020	2021
Mechanical treatment and storage <sup>1</sup>		kt/Mt tds	2.70	2.70	2.70	2.70	2.70	2.70	2.70	2.70	2.70	2.70
Additional Treatment	Digested <sup>2</sup>	kt/Mt tds	18.10	18.10	18.10	18.10	17.83	15.90	13.37	13.03	12.26	11.90
	Advanced Digested	kt/Mt tds	4.53	4.53	4.53	4.53	4.53	4.52	4.53	4.52	4.52	4.51
	Composted	kt/Mt tds	1.50	1.50	1.50	1.50	1.50	1.50	1.50	1.50	1.50	1.50

Process stage	Process type	unit	1990	1995	2000	2005	2010	2015	2018	2019	2020	2021
Disposal route	Land <sup>3</sup>	kt/Mt tds	IE	IE	IE	IE	IE	IE	IE	IE	IE	IE
	Landfill <sup>3</sup>	kt/Mt tds	IE	IE	IE	IE	IE	IE	IE	IE	IE	IE
	Incineration <sup>3</sup>	kt/Mt tds	IE	IE	IE	IE	IE	IE	IE	IE	IE	IE
	Sea <sup>4</sup>	kt/Mt tds	60.00	60.00	60.00	60.00	60.00	60.00	60.00	60.00	60.00	60.00
Total <sup>5</sup>		kt/Mt tds	33.13	31.29	24.49	12.71	13.98	11.73	9.84	9.56	9.43	9.08

1. All waste is mechanically treated and stored, so the emission factor is applied to total sludge.

2. Implied emission factor after methane capture.

3. To avoid confusion, emissions factors are not presented in this table, as emissions are reported in other sectors (see **Section 7.1.1**).

4. Not an IEF, this is the default IPCC factor for sea, river and lake discharge.

5. For information, IEF when dividing total emissions by total activity.

**Table A 3.5.12 UK Domestic and Commercial Waste Water Treatment (5D1) Emission Estimates (kt CH<sub>4</sub>)**

Process stage	Process type	1990	1995	2000	2005	2010	2015	2018	2019	2020	2021
Mechanical treatment and storage <sup>1</sup>		2.12	2.34	2.94	4.77	4.47	4.31	4.56	4.56	4.51	4.62
Additional Treatment	Digested <sup>2</sup>	8.90	9.61	9.37	16.36	17.02	12.08	8.82	7.79	7.37	6.89
	Advanced Digested	-	-	0.26	1.32	1.62	2.33	3.22	3.77	3.87	4.03
	Composted	-	-	0.01	0.02	0.04	0.01	0.00	0.01	0.00	0.00
Disposal route	Farmland <sup>3</sup>	IE	IE	IE	IE	IE	IE	IE	IE	IE	IE
	Landfill <sup>3</sup>	IE	IE	IE	IE	IE	IE	IE	IE	IE	IE
	Incineration <sup>3</sup>	IE	IE	IE	IE	IE	IE	IE	IE	IE	IE
	Sea <sup>4</sup>	33.50	31.65	23.74	-	-	-	-	-	-	-
Total <sup>5</sup>		44.52	43.60	36.32	22.47	23.15	18.73	16.60	16.12	15.75	15.55

**Table A 3.5.13 UK Private Waste Water Management System Emission Estimates Parameters (5D1)**

Data	Unit	1990	1995	2000	2005	2010	2015	2018	2019	2020	2021
Estimated population connected to private wastewater management systems	population (thousands)	1417.20	1440.65	1438.70	1465.31	1525.80	1577.78	1605.82	1606.95	1613.66	1613.77
BOD value applied	g/person/day	53.21	54.42	57.04	67.77	64.43	59.92	62.65	61.80	63.83	65.97

**A 3.5.4.2 5D2 Industrial Wastewater Handling and Sludge Disposal**

**Table A 3.5.14 UK Industrial Wastewater Treatment Activity Data, total industrial product per sector (5D2)**

Industry	Units	1990	1995	2000	2005	2010	2015	2018	2019	2020	2021
Alcohol refining	kt	458	469	446	552	577	645	649	725	653	700
Beer & malt	kt	7,788	7,983	6,709	7,211	6,571	6,664	6,230	5,821	5,507	7,101
Coffee	kt	11	11	63	74	78	83	85	90	92	96
Dairy Products	kt	6,755	6,924	6,172	6,223	8,594	9,363	9,254	8,667	8,261	8,673
Fish processing	kt	187	191	362	363	272	230	183	174	160	159
Iron and Steel manufacturing	kt	235	214	177	98	301	835	203	205	216	247
Meat & Poultry	kt	2,640	2,706	2,617	2,855	2,656	3,244	3,725	3,578	3,729	3,810
Organic chemicals	kt	132	158	129	65	1,184	438	336	303	297	540
Petroleum Refineries	kt	66,972	86,131	81,129	80,145	68,599	57,577	54,871	55,407	45,262	45,485
Nitrogen fertiliser	kt	853	1,021	1,021	1,021	1,075	1,762	2,139	2,977	3,590	3,853
Plastics & resins	kt	964	1,413	1,334	1,741	1,650	1,823	1,690	1,723	1,682	1,871

Industry	Units	1990	1995	2000	2005	2010	2015	2018	2019	2020	2021
Pulp & Paper	kt	8,640	8,625	8,222	7,957	6,787	7,241	6,804	6,647	6,689	7,280
Soap & detergents	kt	126	151	210	253	282	260	105	116	188	235
Starch production	kt	22	23	10	57	187	87	101	126	125	123
Sugar Refining	kt	35	35	40	25	21	18	15	13	13	13
Vegetable Oils	kt	295	302	288	346	411	612	397	386	419	372
Vegetables, Fruits & Juices	kt	995	1,020	1,068	1,085	808	893	1,041	904	738	871
Wine & Vinegar	kt	545	559	604	702	685	2,007	2,548	1,710	845	912

## A 3.6 UK CROWN DEPENDENCIES AND OVERSEAS TERRITORIES

### A 3.6.1 Overview of Data Sources

Fuel use data for Isle of Man, Guernsey and Jersey are assumed to be included in UK national energy statistics (see **Section 1.1.2.2**), so fuel thought to be used in these territories are split out from UK total consumption unless otherwise stated in **Section A 4.2.1**.

Activity data including fuel use data for other territories are obtained from government departments for those territories, specifically:

- Bermuda: Department of Statistics;
- Cayman Islands: Department of Environment Sustainable Development Unit; and,
- Falkland Islands: Environmental Department, Policy & Economic Development Unit.

Activity and emissions data estimates from LULUCF sources and sinks have been researched via the FAOSTAT database, to supplement data available from the OTs. The LULUCF data for Cayman Islands from FAOSTAT (FAO, 2018) indicates zero emissions, using Tier 1 methods. The data sources and methodologies used for other sectors are described in the main methodology sections of the NIR.

**A 3.6.2 Activity and Emissions Data****Table A 3.6.1 Isle of Man, Guernsey and Jersey - Emissions of Direct GHGs (Mt CO<sub>2</sub> equivalent)**

Sector	1990	1995	2000	2005	2010	2015	2018	2019	2020	2021
1. Energy	1.49	1.66	1.73	1.4	1.3	1.15	1.22	1.3	1.04	1.01
2. Industrial Processes and Product Use	0.00178	0.00476	0.0177	0.0353	0.0549	0.0627	0.0619	0.0591	0.0554	0.0552
3. Agriculture	0.184	0.188	0.195	0.182	0.167	0.16	0.152	0.15	0.15	0.147
4. LULUCF	-0.0251	-0.0277	-0.0237	-0.0147	-0.00942	-0.0146	-0.0247	-0.0262	-0.0256	-0.0268
5. Waste	0.117	0.119	0.122	0.121	0.105	0.0884	0.0807	0.078	0.0729	0.0732
7. Other										
<b>Total</b>	<b>1.77</b>	<b>1.94</b>	<b>2.04</b>	<b>1.72</b>	<b>1.62</b>	<b>1.44</b>	<b>1.49</b>	<b>1.56</b>	<b>1.30</b>	<b>1.26</b>

**Table A 3.6.2 Isle of Man, Guernsey and Jersey - Combustion activity data**

Fuel	Fuel Unit	1990	1995	2000	2005	2010	2015	2018	2019	2020	2021
Aviation spirit	TJ	95.6	109	157	163	85.8	44.8	28.9	18	2.35	17.5
Aviation turbine fuel	TJ	1270	1220	1540	1670	1480	1350	1450	1490	534	717
Burning oil	TJ	2890	3370	4630	3980	3760	3210	3400	3220	3280	3340
Clinical waste	Mt	0.000588	0.000588	0.000588	0.000588	0.000588	0.000588	0.000596	0.0006	0.000482	0.000486
Coal	TJ	329	210	149	100	8.2	8.84	8.81	8.81	8.81	8.81
DERV	TJ	1060	1340	1920	1690	1800	1920	2040	2000	1840	1900
Fuel oil	TJ	6360	7870	5890	1070	1210	819	893	1710	222	211



Fuel	Fuel Unit	1990	1995	2000	2005	2010	2015	2018	2019	2020	2021
Gas oil	TJ	3370	3630	3610	3070	2220	1880	2050	1900	1580	1750
LPG	TJ	842	833	2000	1270	1120	687	692	660	589	478
MSW	TJ	268	374	479	866	795	829	865	858	825	915
Natural gas	TJ				3190	3810	3520	4100	4880	4730	3480
Petrol	TJ	3540	3420	3250	3290	2880	2540	2330	2290	1960	2050
Urea consumption	TJ					0.000295	0.000685	0.000811	0.000813	0.000733	0.000777

**Table A 3.6.3 Isle of Man, Guernsey and Jersey - Animal numbers**

Livestock Category	1990	1995	2000	2005	2010	2015	2018	2019	2020	2021
Dairy	15,888	15,729	16,186	13,127	11,511	10,846	11,192	10,807	10,687	10,300
Non-dairy	28,663	28,333	29,176	31,719	28,821	26,643	23,927	22,893	23,718	23,053
Sheep	151,764	160,228	176,259	151,103	138,251	133,666	126,029	128,599	124,647	123,963
Pigs	4,854	5,411	4,609	1,148	4,086	2,861	2,188	2,154	2,391	1,966
Poultry	84,048	46,481	46,448	58,160	54,400	62,916	59,485	59,734	60,408	60,271
Goats	333	347	376	141	288	539	458	484	452	435
Horses	2,785	2,785	2,785	2,822	3,236	2,891	2,536	2,591	2,591	2,591

**Table A 3.6.4 Isle of Man, Guernsey and Jersey - Total emissions from Agricultural Soils (Mt CO<sub>2</sub> equivalent)**

Territory	1990	1995	2000	2005	2010	2015	2018	2019	2020	2021
Isle of Man	0.0380	0.0383	0.0345	0.0284	0.0244	0.0227	0.0226	0.0221	0.0220	0.0218
Guernsey	0.0029	0.0030	0.0026	0.0024	0.0024	0.0025	0.0025	0.0024	0.0023	0.0023
Jersey	0.0081	0.0085	0.0083	0.0072	0.0070	0.0069	0.0068	0.0067	0.0061	0.0061

**Table A 3.6.5 Cayman Islands, Falklands Islands, and Bermuda - Emissions of Direct GHGs (Mt CO<sub>2</sub> equivalent)**

Sector	1990	1995	2000	2005	2010	2015	2018	2019	2020	2021
1. Energy	1.32	1.31	1.43	1.6	1.57	1.72	1.67	1.67	1.44	1.59
2. Industrial Processes and Product Use	0.000342	0.00208	0.011	0.0755	0.192	0.342	0.41	0.406	0.388	0.415
3. Agriculture	0.282	0.272	0.256	0.228	0.189	0.186	0.179	0.185	0.174	0.188
4. LULUCF	0.0941	0.0912	0.0956	0.0946	0.222	0.107	0.106	0.107	0.107	0.108
5. Waste	0.123	0.107	0.0877	0.0878	0.136	0.115	0.121	0.124	0.13	0.137
7. Other										
<b>Total</b>	<b>1.82</b>	<b>1.78</b>	<b>1.88</b>	<b>2.09</b>	<b>2.31</b>	<b>2.47</b>	<b>2.49</b>	<b>2.5</b>	<b>2.24</b>	<b>2.44</b>

**Table A 3.6.6 Cayman Islands, Falklands Islands, and Bermuda - Combustion activity data**

Fuel	Fuel Unit	1990	1995	2000	2005	2010	2015	2018	2019	2020	2021
Aviation spirit	TJ	1.88									
Aviation turbine fuel	TJ	3990	2850	2950	2630	2870	2590	2840	2900	1280	990
Burning oil	TJ	63.5	78.6	90.5	117	106	130	128	138	134	118

Fuel	Fuel Unit	1990	1995	2000	2005	2010	2015	2018	2019	2020	2021
DERV	TJ	2150	1840	1530	3390	1430	1800	1750	2040	1460	1720
Fuel oil	TJ	1970	2060	3600	4140	4300	4410	4660	4720	4510	4570
Gas oil	TJ	8070	8770	9050	9660	10300	12000	10700	10100	9080	10300
LPG	TJ	258	288	320	369	378	413	461	496	492	455
MSW	TJ	0.931	453	453	453	426	362	484	450	444	455
Natural gas	TJ	1.47	1.82	2.1	2.63	3.13	3.44	3.17	3.23	3.16	2.97
Petrol	TJ	2830	2880	3210	2540	2940	3040	3410	3620	2690	3120
Urea consumption	Mt					0.000208	0.000652	0.000692	0.000761	0.000641	0.000694
Lubricants	TJ	63.9	76	75.8	73.8	69.1	59.8	58.1	59.6	44.4	47.9
Petroleum waxes	kg	83,500	71,700	58,400	139,000	72,700	88,100	75,300	95,400	81,300	77,200

**Table A 3.6.7 Cayman Islands, Falklands Islands, and Bermuda - Animal numbers**

Livestock Category	1990	1995	2000	2005	2010	2015	2018	2019	2020	2021
Dairy Cattle	2,161	1,862	1,911	1,145	868	675	598	595	580	583
Non-dairy Cattle	5,256	4,861	5,077	7,845	6,360	4,748	4,772	4,860	5,003	4,883
Sheep	739,999	717,571	669,905	580,864	478,625	482,131	462,245	476,867	444,834	487,237
Goats	405	867	1,286	1,704	2,251	1,986	2,775	2,939	2,963	2,989
Horses	2,217	2,069	1,703	1,417	1,269	1,223	1,221	1,227	1,184	1,195
Swine	1,116	1,174	1,376	1,384	1,233	1,058	1,485	1,579	1,502	1,489

Livestock Category	1990	1995	2000	2005	2010	2015	2018	2019	2020	2021
Poultry	15,319	14,664	20,890	27,164	32,293	39,458	30,019	31,805	33,844	33,584
Deer	0	0	0	0	184	287	339	358	378	400

**Table A 3.6.8 Cayman Islands, Falklands Islands, and Bermuda - Total emissions from Agricultural Soils (Mt CO<sub>2</sub> equivalent)**

Territory	1990	1995	2000	2005	2010	2015	2018	2019	2020	2021
Bermuda	0.0006	0.0007	0.0007	0.0007	0.0007	0.0007	0.0007	0.0007	0.0007	0.0007
Cayman Islands	0.0007	0.0009	0.0010	0.0011	0.0012	0.0010	0.0011	0.0011	0.0012	0.0012
Falkland Islands	0.0963	0.0930	0.0870	0.0764	0.0638	0.0636	0.0612	0.0630	0.0590	0.0642

**Table A 3.6.9 Cayman Islands, Falklands Islands, and Bermuda - Amount of synthetic fertilizer applied**

Country	kg N applied
Cayman Islands	31,198
Falkland Islands	0
Bermuda	1,480

**Table A 3.6.10 Gibraltar - Emissions of Direct GHGs (Mt CO<sub>2</sub> equivalent)**

Sector	1990	1995	2000	2005	2010	2015	2018	2019	2020	2021
1. Energy	0.216	0.214	0.240	0.275	0.286	0.357	0.321	0.295	0.236	0.255
2. Industrial Processes and Other Product Use	0.000	0.001	0.002	0.012	0.028	0.050	0.056	0.056	0.055	0.056
3. Agriculture	-	-	-	-	-	-	-	-	-	-

Sector	1990	1995	2000	2005	2010	2015	2018	2019	2020	2021
4. LULUCF	-	-	-	-	-	-	-	-	-	-
5. Waste	0.007	0.009	0.012	0.001	0.003	0.002	0.002	0.002	0.002	0.002
Total	<b>0.224</b>	<b>0.224</b>	<b>0.254</b>	<b>0.288</b>	<b>0.317</b>	<b>0.409</b>	<b>0.379</b>	<b>0.352</b>	<b>0.292</b>	<b>0.313</b>

**Table A 3.6.11 Gibraltar - Combustion activity data**

Fuel	Fuel Unit	1990	1995	2000	2005	2010	2015	2018	2019	2020	2021
Aviation spirit	TJ (net)	3	-	-	-	-	-	-	-	-	-
Aviation turbine fuel	TJ (net)	809	722	540	840	695	873	800	927	415	643
Clinical waste	kt	-	-	-	-	5.43	0.92	1.07	1.07	1.07	1.07
Charcoal	TJ (net)	-	0	0	0	0	0	0	2	3	3
DERV	TJ (net)	229	200	417	975	1,026	2,210	2,291	1,760	1,462	1,938
Fuel oil	TJ (net)	35,956	36,499	61,925	90,757	104,465	101,866	99,845	95,021	97,851	99,832
Gas oil	TJ (net)	4,539	5,052	6,953	9,495	11,379	13,714	13,265	10,066	8,264	7,470
LPG	TJ (net)	1,140	1,140	1,140	1,140	1,140	1,140	1,199	1,272	1,252	1,291
MSW	TJ (net)	327	379	481	-	-	-	-	-	-	-
Natural gas	TJ (net)	-	-	-	-	-	-	-	1,780	3,388	4,288
Petrol	TJ (net)	895	765	1,059	1,061	989	915	1,036	945	945	986
Petroleum waxes	Mt	0.03	0.02	0.01	0.03	0.02	0.02	0.02	0.02	0.02	0.02

Fuel	Fuel Unit	1990	1995	2000	2005	2010	2015	2018	2019	2020	2021
Lubricants	TJ (net)	68	66	57	56	52	47	45	44	34	36

**Table A 3.6.12 Isle of Man, Guernsey and Jersey – Total Municipal Solid Waste activity data (Gg)**

Territory	1990	1995	2000	2005	2010	2015	2018	2019	2020	2021
Isle of Man	36.5	39.7	40.8	0	0	0	0	0	0	0
Guernsey	56.7	56.7	56.7	56.7	35.0	33.1	27.2	4.16	3.72	2.59
Jersey	N/A	N/A	N/A	N/A	N/A	N/A	N/A	N/A	N/A	N/A

**Table A 3.6.13 Cayman Islands, Falklands Islands, and Bermuda – Total Municipal Solid Waste activity data (Gg)**

Territory	1990	1995	2000	2005	2010	2015	2018	2019	2020	2021
Cayman Islands	33.8	33.8	33.8	144	94.1	63.3	108	136	136	113
Falklands Islands	1.00	1.00	1.00	1.00	1.00	1.00	1.00	1.00	1.00	1.00
Bermuda	64.5	10.0	10.0	10.0	10.0	10.0	10.0	10.0	10.0	10.0

---

## ANNEX 4: National Energy Balance

### A 4.1 UK ENERGY BALANCE

The UK energy balance is produced and published annually by the Department of Energy Security and Net Zero in the Digest of UK Energy Statistics – DUKES. This is available online from:

<https://www.gov.uk/government/collections/digest-of-uk-energy-statistics-dukes>

The aggregate energy balance for the latest year is presented below (Table 1.1 in DUKES). The following sections explain how the energy balance is used for the UK inventory for individual fuel types, and how the data are supplemented with other statistics that may lead to deviations from the DUKES statistics.

The UK energy statistics (detailed breakdown) are presented on a mass basis for liquid and solid fuels, and on a gross energy basis for gaseous fuels (including derived gases). The UK inventory is calculated using these data directly, and for the purposes of reporting in the CRF and NIR, activity data and emission factors are converted to energy units, on a net basis.

The scope of the UK energy balance, as shown below, is fuel use in the United Kingdom and its Crown Dependencies (Jersey, Guernsey and the Isle of Man), as described in the NIR **Section 1.1.2.2**.

The fuel use estimates for Overseas Territories (OTs) are not included within DUKES, and are obtained through direct communications with the respective government contacts in each of the OTs.

# National Energy Balance **A4**

**Table A 4.1.1 UK Energy Balance for 2021 (thousand tonnes of oil equivalent, gross energy basis)**

	Coal	Manufactured fuel [note 1]	Primary oils	Petroleum products	Natural gas [note 2]	Bioenergy & waste [note 3]	Primary electricity	Electricity	Heat sold	Total
Production	736	0	44,737	0	31,323	12,829	16,979	0	0	106,604
Imports	3,197	781	45,705	26,927	48,223	5,380	0	2,471	0	132,683
Exports	-743	-8	-37,029	-20,001	-6,507	-388	0	-358	0	-65,035
Marine bunkers	0	0	0	-2,071	0	0	0	0	0	-2,071
Stock change [note 4]	+1,786	+144	+159	+1,616	+99	+4	0	0	0	+3,808
<b>Total supply</b>	<b>4,976</b>	<b>916</b>	<b>53,573</b>	<b>6,470</b>	<b>73,137</b>	<b>17,825</b>	<b>16,979</b>	<b>2,113</b>	<b>0</b>	<b>175,990</b>
<b>Statistical difference [note 5]</b>	<b>-16</b>	<b>+0</b>	<b>+2</b>	<b>-17</b>	<b>-336</b>	<b>0</b>	<b>0</b>	<b>-83</b>	<b>0</b>	<b>-450</b>
<b>Total demand</b>	<b>4,992</b>	<b>916</b>	<b>53,571</b>	<b>6,488</b>	<b>73,473</b>	<b>17,825</b>	<b>16,979</b>	<b>2,196</b>	<b>0</b>	<b>176,440</b>
Transfers	0	+20	-627	+613	+532	-557	-7,077	+7,077	0	-19
<b>Transformation</b>	<b>-3,750</b>	<b>194</b>	<b>-52,944</b>	<b>52,116</b>	<b>-24,241</b>	<b>-11,570</b>	<b>-9,903</b>	<b>19,300</b>	<b>1,591</b>	<b>-29,207</b>
Electricity generation	-1,680	-401	0	-353	-21,837	-11,358	-9,903	19,300	0	-26,231
Major power producers	-1,668	0	0	-117	-19,625	-5,740	-9,903	16,129	0	-20,924
Autogenerators	-12	-401	0	-235	-2,212	-5,618	0	3,171	0	-5,307
Heat generation	-4	-1	0	-40	-2,404	-212	0	0	1,591	-1,069
Petroleum refineries	0	0	-53,268	52,923	0	0	0	0	0	-345
Coke manufacture	-1,174	1,095	0	0	0	0	0	0	0	-79
Blast furnaces	-805	-621	0	0	0	0	0	0	0	-1,426
Patent fuel manufacture	-88	122	0	-59	0	0	0	0	0	-24
Other [note 6]	0	0	324	-356	0	0	0	0	0	-32
<b>Energy industry use</b>	<b>0</b>	<b>392</b>	<b>0</b>	<b>3,447</b>	<b>4,458</b>	<b>0</b>	<b>0</b>	<b>1,734</b>	<b>334</b>	<b>10,365</b>
Electricity generation	0	0	0	0	0	0	0	1,066	0	1,066
Oil and gas extraction	0	0	0	633	3,682	0	0	53	0	4,367
Petroleum refineries	0	0	0	2,814	236	0	0	401	334	3,786



# National Energy Balance **A4**

	Coal	Manufactured fuel [note 1]	Primary oils	Petroleum products	Natural gas [note 2]	Bioenergy & waste [note 3]	Primary electricity	Electricity	Heat sold	Total
Coal extraction	0	0	0	0	5	0	0	28	0	33
Coke manufacture	0	142	0	0	0	0	0	1	0	143
Blast furnaces	0	250	0	0	38	0	0	15	0	303
Patent fuel manufacture	0	0	0	0	0	0	0	0	0	0
Pumped storage	0	0	0	0	0	0	0	53	0	53
Other	0	0	0	0	497	0	0	115	0	612
<b>Losses</b>	<b>0</b>	<b>147</b>	<b>0</b>	<b>0</b>	<b>342</b>	<b>0</b>	<b>0</b>	<b>2,262</b>	<b>0</b>	<b>2,751</b>
<b>Final consumption</b>	<b>1,241</b>	<b>591</b>	<b>0</b>	<b>55,770</b>	<b>44,965</b>	<b>5,697</b>	<b>0</b>	<b>24,577</b>	<b>1,257</b>	<b>134,099</b>
<b>Industry</b>	<b>881</b>	<b>426</b>	<b>0</b>	<b>2,572</b>	<b>9,181</b>	<b>1,672</b>	<b>0</b>	<b>7,318</b>	<b>706</b>	<b>22,756</b>
Unclassified	0	0	0	1,629	0	549	0	0	0	2,178
Iron and steel	13	426	0	10	436	2	0	194	0	1,081
Non-ferrous metals	17	0	0	8	255	0	0	343	0	622
Mineral products	399	0	0	188	1,453	336	0	499	0	2,875
Chemicals	32	0	0	101	1,792	116	0	1,263	212	3,515
Mechanical engineering etc	8	0	0	0	1,020	0	0	482	0	1,511
Electrical engineering etc	4	0	0	1	312	0	0	499	0	815
Vehicles	33	0	0	154	433	12	0	302	0	935
Food, beverages etc	37	0	0	120	1,725	77	0	941	7	2,907
Textiles, leather etc	39	0	0	44	256	0	0	216	0	556
Paper, printing etc	54	0	0	33	352	285	0	787	4	1,514
Other industries	240	0	0	41	720	294	0	1,681	483	3,460
Construction	5	0	0	242	427	0	0	111	0	786
<b>Transport</b>	<b>10</b>	<b>0</b>	<b>0</b>	<b>41,593</b>	<b>84</b>	<b>1,463</b>	<b>0</b>	<b>475</b>	<b>0</b>	<b>43,625</b>
Air	0	0	0	5,176	0	0	0	0	0	5,176
Rail	10	0	0	552	0	0	0	401	0	963

# National Energy Balance **A4**

	Coal	Manufactured fuel [note 1]	Primary oils	Petroleum products	Natural gas [note 2]	Bioenergy & waste [note 3]	Primary electricity	Electricity	Heat sold	Total
Road	0	0	0	35,229	84	1,463	0	74	0	36,850
National navigation	0	0	0	636	0	0	0	0	0	636
Pipelines	0	0	0	0	0	0	0	0	0	0
<b>Other</b>	<b>350</b>	<b>122</b>	<b>0</b>	<b>6,140</b>	<b>35,323</b>	<b>2,563</b>	<b>0</b>	<b>16,784</b>	<b>551</b>	<b>61,833</b>
Domestic	328	122	0	2,489	27,377	1,127	0	9,411	260	41,115
Public administration	14	0	0	713	3,015	56	0	1,423	79	5,299
Commercial	4	0	0	1,596	3,937	1,229	0	5,616	206	12,588
Agriculture	0	0	0	920	114	133	0	334	4	1,505
Miscellaneous	5	0	0	421	880	18	0	0	1	1,325
<b>Non energy use</b>	<b>0</b>	<b>43</b>	<b>0</b>	<b>5,466</b>	<b>377</b>	<b>0</b>	<b>0</b>	<b>0</b>	<b>0</b>	<b>5,886</b>

Note 1 Includes all manufactured solid fuels, benzole, tars, coke oven gas and blast furnace gas.

Note 2 Includes colliery methane.

Note 3 Includes geothermal, solar heat, and heat pumps.

Note 4 Stock fall (+), stock rise (-).

Note 5 Primary supply minus primary demand.

Note 6 Back-flows from the petrochemical industry.

## A 4.2 FUELS DATA

The fuels data are taken from DUKES - the Digest of UK Energy Statistics (BEIS, 2021), so the fuel definitions and the source categories used in the NAEI reflect those in DUKES.

IPCC Guidelines (IPCC, 2006) lists fuels that should be considered when reporting emissions. **Table A 4.2.1** lists the fuels that are used in the GHGI (based on DUKES) and indicates how they relate to the fuels listed in the IPCC Guidelines. In most cases the mapping is obvious but there are a few cases where some explanation is required.

**Table A 4.2.1 Mapping of fuels used in IPCC and the NAEI**

Category	IPCC Fuel Name	NAEI Fuel Name
Liquid	Motor Gasoline	Petrol
	Aviation Gasoline	Aviation Spirit
	Jet Kerosene	Aviation Turbine Fuel <sup>1</sup> (ATF)
	Other Kerosene	Burning Oil
	Gas/Diesel Oil	Gas Oil/ DERV
	Residual Fuel Oil	Fuel Oil
	Orimulsion	Orimulsion
	Liquefied Petroleum Gases	Liquefied Petroleum Gas (LPG)
	Naphtha	Naphtha
	Petroleum Coke	Petroleum Coke
	Refinery Gas	Other Petroleum Gas (OPG)
	Other Oil: Other Petroleum Products	Refinery Miscellaneous
	Lubricants	Lubricants
Solid	Anthracite	Anthracite
	Coking Coal	Coal <sup>2</sup>
	Other Bituminous Coal	Coal
		Slurry <sup>3</sup>
	Coke Oven Coke	Coke
	Patent Fuel	Solid Smokeless Fuel (SSF)
	Coke Oven Gas	Coke Oven Gas
	Blast Furnace Gas	Blast Furnace Gas

Category	IPCC Fuel Name	NAEI Fuel Name
Gaseous	Natural Gas	Natural Gas
		Sour Gas <sup>4</sup>
		Colliery Methane <sup>5</sup>
Other Fuels	Municipal Solid Waste	Municipal Solid Waste
	Industrial Waste: Scrap Tyres	Scrap Tyres
	Waste Oils	Waste Oil
Peat	Peat	Peat
Biomass	Wood/Wood Waste	Wood
	Other Primary Solid Biomass	Straw
		Poultry Litter, Meat & bone meal
	Landfill Gas	Landfill Gas
	Sludge Gas	Sewage Gas
	Charcoal	Charcoal
	Other liquid biofuels	Liquid Biofuels
	Other biogas	Biogas

- 1 Includes fuel that is correctly termed jet gasoline.
- 2 Used in coke ovens.
- 3 Coal-water slurry used in some power stations
- 4 Unrefined natural gas used on offshore platforms and some power stations
- 5 IPCC Guidelines (IPCC, 2006) specifies coal seam methane is included in Natural Gas.

### **A 4.2.1 Reallocations of energy data and differences from UK energy statistics**

The main source of energy consumption data used in the UK inventory is the Digest of UK Energy Statistics (DUKES; BEIS, 2022). This annual publication gives detailed sectoral energy consumption broken down by fuel type and covering the entire time period of the inventory. In many cases, these data are used directly in the inventory without modification. However, there are instances where the activity data used are not based directly on DUKES, instead utilising alternative data sources which provide supplementary information to the allocation of fuel to individual sectors and sources. In general, the UK inventory totals by fuel are kept consistent with the DUKES national totals for each fuel. There are some exceptions where the UK total may be different to that presented in DUKES due to different scopes and reporting requirements.

The reasons for any deviations from use of DUKES data in the inventory are discussed within the source category methodological descriptions in Section 3 of the main report. The main reasons for reallocations or modifications are:

- To account for differences in geographical scope (e.g. to account for energy use in OTs)

- To make best use of EU ETS data (this data is only used indirectly in producing UK energy statistics)
- To utilise other operator reported data (e.g. direct to the Inventory Agency, or to environmental or industry regulators).
- When bottom-up models are available providing fuel consumption data on a more granular level and are considered to be a higher quality estimate by the Inventory Agency.

The fuel reconciliation tables (**Table A 4.2.2 - Table A 4.2.7**) show how the deviations are applied and how the energy data for the major fuels in the UK inventory are reconciled against the energy demand data from DUKES. The tables show:

1. Where fuels are re-allocated between sectors, but the overall annual fuel consumption across all UK sectors is kept consistent with the data in DUKES; and
2. Where deviations are made to DUKES figures for total UK consumption of a given fuel, and in which source categories these deviations are made.

The Inventory Agency presents data below for the fuel allocations for coal, natural gas, fuel oil, gas oil (including DERV) and petroleum gases (LPG, OPG) for the latest inventory year. Together these fuels constitute the majority of the UK inventory 1A sector emissions total.

Deviations to the energy balance are made in consultation with the authors of the energy statistics.

#### **A 4.2.1.1 Coal**

Total coal use within the GHG inventory is consistent with the DUKES total and in most cases, coal use at the sectoral level is also consistent with the DUKES data. However, there are several instances where operator-reported data, either via trade associations such as the Mineral Products Association, or through EU ETS, indicates slight differences from the DUKES statistics. In those cases, the Inventory Agency deviates from DUKES to ensure higher accuracy for those source categories. Overall, however, the DUKES demand total is regarded as complete and accurate and therefore the 1A2gviii Other Industrial Combustion is used as the 'residual' source category, to deliver exact reconciliation between GHGI activity and the DUKES demand total. **Table A 4.2.2** below presents the comparison between UK inventory estimates with DUKES estimates for the latest inventory year.

**Table A 4.2.2 Fuel reconciliation: Coal use in the latest year (Mtonnes)**

Dukes Category	Activity (MT)	GHGI	IPCC Sector	Activity (MT)	Difference	Comment
Major power producers	2.635	Power Stations	1A1ai	2.635	0.000	
Autogenerators	0.019	Autogenerators (inc. exports to grid)	1A2b	0.019	-	
Heat generation	0.006	IE		-	-	Heat generation emissions are considered to be included within the 'Other' section below under sources like public and misc combustion

Dukes Category	Activity (MT)	GHGI	IPCC Sector	Activity (MT)	Difference	Comment
Coke manufacture	1.544	Coke manufacture	2C1	1.486	0.058	Operator-provided data used in preference to DUKES
Blast furnaces	1.059	Blast furnaces	1B1b	1.059	-	
Patent fuel manufacture	0.137	Solid smokeless fuel production	1B1b	0.137	-	
Coal extraction	-	Collieries - combustion	1A1ciii	-	-	
Other industries	0.500	Other industrial combustion	1A2gviii	0.545	-0.046	Industrial combustion emissions are scaled to account for net differences in activity implied by using I&S operator data
Iron and steel	0.021	Iron and steel - combustion plant	1A2a	0.021	-	Operator-provided data used in preference to DUKES
Non ferrous metals	0.029	Non-ferrous metal (combustion)	1A2b	0.029	0.000	Industrial combustion emissions are scaled to account for net differences in activity implied by using I&S operator data
Cement production	0.605	Cement processes	1A2f	0.620	-0.015	Cement and lime sector data from MPA and EU ETS used in preference to DUKES
Chemicals	0.050	Chemicals (combustion)	1A2c	0.050	-	Industrial combustion emissions are scaled to account for net differences in activity implied by using I&S operator data
food beverages	0.055	Food & drink, tobacco (combustion)	1A2e	0.055	-	Industrial combustion emissions are scaled to account for net differences in activity implied by using I&S operator data
Paper printing	0.094	Pulp, Paper and Print (combustion)	1A2d	0.094	-0.000	Industrial combustion emissions are scaled to account for net differences in activity implied by using I&S operator data
<b>Sub-total</b>	1.354	<b>Sub-total</b>	$\Sigma$ 1A2	1.414	-0.061	Some operator data used, also some re-allocation of heat generation data.
Rail	0.014	Rail transport	1A3c	0.014	-	
Domestic	0.480	Domestic combustion	1A4bi	0.480	0.000	

Dukes Category	Activity (MT)	GHGI	IPCC Sector	Activity (MT)	Difference	Comment
Public Administration	0.019	Public sector combustion	1A4ai	0.023	-0.004	Some reallocation from industry and heat-generation
Commercial	0.005	Miscellaneous industrial/commercial combustion	1A4ai	0.012	-0.000	Some reallocation from industry and heat-generation
Miscellaneous	0.007		1A4ci	-	-	
Agriculture	-	Agriculture (mobile & stationary combustion)	1A4ai	-	-	
<b>TOTAL</b>	<b>7.279</b>	<b>TOTAL</b>	<b>1A2e</b>	<b>7.279</b>	<b>-0.000</b>	<b>Fully reconciled to DUKES demand total.</b>

Notes: Rows are shaded to help illustrate reconciliation between sectors.

#### A 4.2.1.2 Natural Gas

Data for natural gas use is largely taken directly from DUKES and the national total is consistent between the inventory and the energy statistics, other than a small additional use of natural gas at a number of (international) gas pipeline inter-connectors and also on the Isle of Man (IoM) which is added to the inventory, as natural gas use on IoM is not included in DUKES demand totals. Operator estimates for ammonia production (both fuel and feedstock), and ETS data for gas separation plant lead to minor reallocations of the DUKES data, these are summarised below in **Table A 4.2.3**. In addition, the NAEI model doesn't include any accounting for losses compared to DUKES tables.

**Table A 4.2.3 Fuel reconciliation: Natural gas and Colliery Methane use in the latest year (TJ net)**

DUKES Category	Activity (TJ net)	GHGI	IPCC Sector	Activity (TJ net)	Difference	Comment
<b>NATURAL GAS</b>						
Major power producers	741,650	Power Stations (UK)	1A1ai	741,518	132	This includes fuel referred to as sour gas in EU ETS
	-	Power Stations (CDs)	1A1ai	2,458	-2,458	Isle of Man gas use is additional, as it is not reported within DUKES
Oil and gas extraction	139,129	Upstream Oil/Gas production	1A1cii	146,379	-7,251	EUETS natural gas use in upstream facilities exceeds DUKES reported total. Inventory uses EUETS in preference and the difference is regarded as additional to the data in the UK energy stats. (See additional commentary in MS for 1A1cii.
Coal extraction	195	Collieries - combustion	1A1ciii	195	0	
Blast furnaces	1,438	Blast furnaces	1A2a	1,438	0	
Other	18,781	Gas production	1A1ciii	19,807	-1,025	From discussion with BEIS, interconnector sites are missing from DUKES

DUKES Category	Activity (TJ net)	GHGI	IPCC Sector	Activity (TJ net)	Difference	Comment
						so additional estimates are provided in the inventory.
Petroleum refineries	21,710	Petroleum Refineries	1A1b	39,698	-17,988	Re-allocation in the GHGI of gas use from autogeneration and railways to the refinery sector
Autogenerators	82,609	Autogeneration (inc. exports to grid)	1A2b/1A2g	65,478	17,132	Re-allocation in the GHGI of gas use from autogeneration and railways to the refinery sector to offset the increased emissions.
	927	Railways - stationary combustion	1A4ai	51		Re-allocation in the GHGI of gas use from autogeneration and railways to the refinery sector to offset the increased emissions.
<b>Subtotal</b>	<b>105,246</b>	<b>Subtotal</b>		<b>105,227</b>	<b>19</b>	
Agriculture	4,469	Agriculture - stationary combustion	1A4ci	4,468	1	
Commercial	164,285	Miscellaneous industrial/commercial combustion	1A4ai	197,515		GHGI total is the sum of DUKES Commercial and Miscellaneous.
Miscellaneous	33,265			-	-	
Domestic	1,034,583	Domestic combustion	1A4bi	1,035,419	-836	Isle of Man gas use not offset against DUKES.
Public Administration	130,418	Public sector combustion	1A4ai	130,395	23	
<b>Subtotal</b>	<b>1,370,199</b>		<b>Subtotal</b>	<b>1,367,798</b>	<b>2,401</b>	<b>Domestic gas use on the Isle of Man is additional, as it is not included in DUKES</b>
Iron and steel	17,977	Iron and steel - combustion plant	1A2a	17,977		
Non-ferrous metals	10,437	Non-Ferrous Metal (combustion)	1A2b	10,435		
Chemicals	87,568	Chemicals (combustion)	1A2c	87,553		
Paper, printing, etc.	18,770	Pulp, Paper and Print (combustion)	1A2d	18,767		
Food, beverages, etc.	70,295	Food & drink, tobacco (combustion)	1A2e	70,282		
	-	Cement processes	1A2f	4,876		
Other	187,787	Other industrial combustion	1A2gviii	167,304		
<i>Subtotal</i>	<b>392,835</b>	<i>Subtotal</i>		<b>377,194</b>	<b>15,641</b>	<b>Whole-sector reconciliation with NEU</b>
NEU	14,256	Ammonia production	2B1	20,980	-	



DUKES Category	Activity (TJ net)	GHGI	IPCC Sector	Activity (TJ net)	Difference	Comment
	-	Other NEU (non-emissive)	n/a	8,843	-	
Subtotal	14,256		Subtotal	29,824	-15,568	Offset by industrial combustion reductions
Losses	12,913	Losses		-	12,913	GHGI doesn't report a 'losses' category in energy units, but directly reports gas transporter estimates of leakage in mass of methane terms.
<b>TOTAL</b>	<b>2,796,642</b>		<b>TOTAL</b>	<b>2,791,838</b>	<b>4,804</b>	<b>GHGI doesn't report a 'losses' category in energy units, but directly reports gas transporter estimates of leakage in mass of methane terms. GHGI allocation for combusted gas is higher than DUKES due to the addition of gas use in the Isle of Man and at gas interconnectors and upstream oil and gas.</b>
<b>TOTAL excl losses</b>	<b>2,783,729</b>		<b>TOTAL excl losses</b>	<b>2,791,838</b>	<b>-8,109</b>	

COLLIERY METHANE						
Autogenerators	964	Collieries - combustion	1A1ciii	964	-	-
Unclassified industry	13	Other industrial combustion	1A2gviii	13	-	-
<b>TOTAL</b>	<b>977</b>	<b>0</b>	<b>TOTAL</b>	<b>977</b>	-	- Exact reconciliation

Notes: Rows are shaded to help illustrate reconciliation between sectors. Note that DUKES activity data is originally in gross energy terms. Reconciliation has been calculated by net terms using a net/gross ratio derived from sources external to DUKES (i.e. from information provided by the GB's gas network operators).

### A 4.2.1.3 Fuel Oil

For shipping, a major research project was completed in 2017 and the results were incorporated from the 2018 submission onwards. The estimated total fuel oil consumption derived from this research is greater than as reported for shipping in DUKES, and any deviations from the national navigation sector are considered additional and are not reconciled elsewhere in the inventory. Additional sectoral deviations are also made to account for known use of fuel oil in power stations, and the Crown Dependencies.

**Table A 4.2.4 Fuel reconciliation: Fuel oil use in latest year (Mtonnes)**

Dukes Category	Activity (MT)	GHGI	IPCC Sector	Activity (MT)	Difference	Comment
Major power producers	0.052	Power Stations	1A1ai	0.050	0.001	EU ETS data used for AD for UK power stations. For CDs, local datasets are used
Autogenerators	0.029	Autogenerators (inc. exports to grid)	1A2b	-	0.029	Fuel reallocated to iron and steel works and other industry on the

Dukes Category	Activity (MT)	GHGI	IPCC Sector	Activity (MT)	Difference	Comment
						basis of data provided by BEIS
Oil gas extraction	0.050	Upstream Oil/Gas production	1A1ciii	-	0.050	Fuel oil allocated to oil and gas extraction in DUKES is reallocated to other industrial combustion
Petroleum refineries	0.112	Refineries - combustion	1A1b	0.112	-	
Other industries	0.054	Other industrial combustion	1A2gviii	0.116	-0.062	Calculated as a residual, to account for differences (e.g. from EU ETS) in power stations, and allocation of autogeneration
Iron and steel	0.005	Iron and steel - combustion plant	1A2a	0.023	-0.018	Increased to account for share of autogeneration and to include fuel allocated to blast furnaces
Non ferrous metals	0.000	Non-ferrous metal (combustion)	1A2b	0.000	-	
Chemicals	0.014	Chemicals (combustion)	1A2c	0.014	-	
food beverages	0.002	Food & drink, tobacco (combustion)	1A2e	0.002	-	
Paper printing	0.001	Pulp, Paper and Print (combustion)	1A2d	0.001	-	
Sub-total	0.076	Sub-total		0.157	-0.081	GHGI allocates residual fuel oil to industry hence this higher GHGI figure reflects no specific allocation to oil and gas, autogeneration etc.
National navigation	-	Shipping - coastal	1A3d	0.158	-	
	-	Shipping between UK and CDs	1A3d	0.000	-	
	-	Shipping between UK and OTs	1A3d	0.006	-	
	-	Fishing vessels	1A4ciii	0.008	-	
Sub-total	-	Sub-total		0.172	-0.172	Bottom-up shipping methodology implies more use of gas oil than in DUKES, and Shipping between the UK and overseas territories is outside of DUKES scope.

Dukes Category	Activity (MT)	GHGI	IPCC Sector	Activity (MT)	Difference	Comment
Marine bunkers	0.597	Marine bunkers	Memo item	0.591	0.006	Shipping between the UK and overseas territories are reallocated to domestic in the NAEI
Public Administration	0.010	Public sector combustion	1A4ai	0.010	-	
Commercial	0.021	Miscellaneous industrial/commercial combustion	1A4ai	0.022	-	
Miscellaneous	0.001			-	-	
Agriculture	0.005	Agriculture (mobile & stationary combustion)	1A4ci	0.005	-	
TOTAL	0.953	TOTAL		1.119	-0.166	Higher overall reported FO use in the GHGI due to coastal shipping and fishing estimates.

notes: Rows are shaded to help illustrate reconciliation between sectors.

#### A 4.2.1.4 Gas Oil

Gas oil is used in both off-road transport and machinery diesel engines, and as a fuel for stationary combustion. The varied use of this fuel and the complexity of the supply chain complicates the means of allocating consumption across the wide range of sectors that use the fuel in the inventory. DUKES provides a breakdown of gas oil consumption in different economic sectors, but the data resolution in DUKES does not distinguish between use of the fuel for stationary combustion and off-road machinery, a distinction which is necessary for the inventory.

There is also a significant quantity of fuel reported in DUKES as 'unclassified' (a higher proportion for gas oil than most other fuels), which means that the UK energy statistics team are currently unable to identify the end users of this portion of fuel use. This reflects that the UK energy statistics team face similar challenges to the inventory team in identifying and allocating gas oil to the many and varied users of the fuel.

To address the inventory requirement to distinguish mobile from stationary fuel use, the GHGI estimates consumption of gas oil and emissions for off-road machinery using a bottom-up method based on estimates of population and usage of different types of machinery, as described in **Section 1.1, MS 6**. However, this has led to a situation where the total amount of gas oil consumption across sectors exceeds that which is available as given in DUKES in many years, particularly recent years.

To address the issue of GHGI bottom-up estimates of fuel consumption being higher than fuel available in the DUKES balance, the inventory team deploys a 6-step method for deciding how fuel is allocated between sources as follows:

1. Separate out sources which should not be factored into the reconciliation (e.g., because they are well understood, like rail, or because the NAEI are deviating from DUKES for that sector, such as national navigation, which is discussed further below), and establish the quantity of gas oil which is available for the sectors being reconciled

2. Always use the de minimis data from established data such as ETS on stationary fuel use. *It is understood that this will in many cases be an underestimate of stationary fuel use.*
3. Always use NRMM fuel use which coincides with DUKES allocations after removing the de minimis for stationary use
4. If there is not enough fuel in the DUKES balance to allocate to bottom-up NRMM estimates, then scale the amount which exceed each DUKES sector. *This effectively means that where the bottom-up estimates agree with DUKES, then there is no scaling, and there is more scaling when there is more disagreement*
5. When there is enough fuel for all bottom-up estimates from the NAEI, split the remaining fuel by the residual of each sector which is not thought to be NRMM capped at the DUKES allocation to each sector.
6. If there is still fuel left in 'unallocated' after all fuel has been allocated in the previous step, then allocate this remainder to 'other industry'

In order to apply step 3 in this process, we are required to map machinery types to DUKES sectors. Many machinery types are not exclusively used by single sectors, so in these cases we have mapped the machinery types to the sectors where we expect the largest use of those machinery would occur. The allocations and rationale are provided in the below table; these have been discussed and agreed with the UK energy statistics team.

**Table A 4.2.5 Mapping of machinery types to dominant sector using machinery<sup>39</sup>**

Machinery type	DUKES end use category to map to	Comments and rationale	Where data are reported
Agriculture	Agriculture	We would expect almost all gas oil used in the agriculture sector to be for use in agricultural machinery, and this equipment is unlikely to be captured in any other sectors.	1A4cii
Airport	Commercial	Gas oil in the UK energy statistics specifically excludes road diesel, and so any gas oil reported as delivered to airports would not be considered a road fuel and allocated to the transport sector, instead it would be allocated to the airport operator, which would be considered 'commercial'. This equipment is unlikely to be captured in any other sectors.	1A3e
Construction	Construction	We would expect almost all gas oil used in the construction sector to be for use in construction machinery, and this equipment is unlikely to be captured in any other sectors.	1A2gvii
Forklifts	Commercial	Likely used across almost all sectors to some degree, although many more intensive users (such as retailers, distributors) would be considered 'commercial' organisations by the energy statistics team.	1A2gvii

<sup>39</sup> House and garden do not appear in this table, as we assume more accessible fuels for general public users (road diesel or petrol) is used for this equipment instead of gas oil.

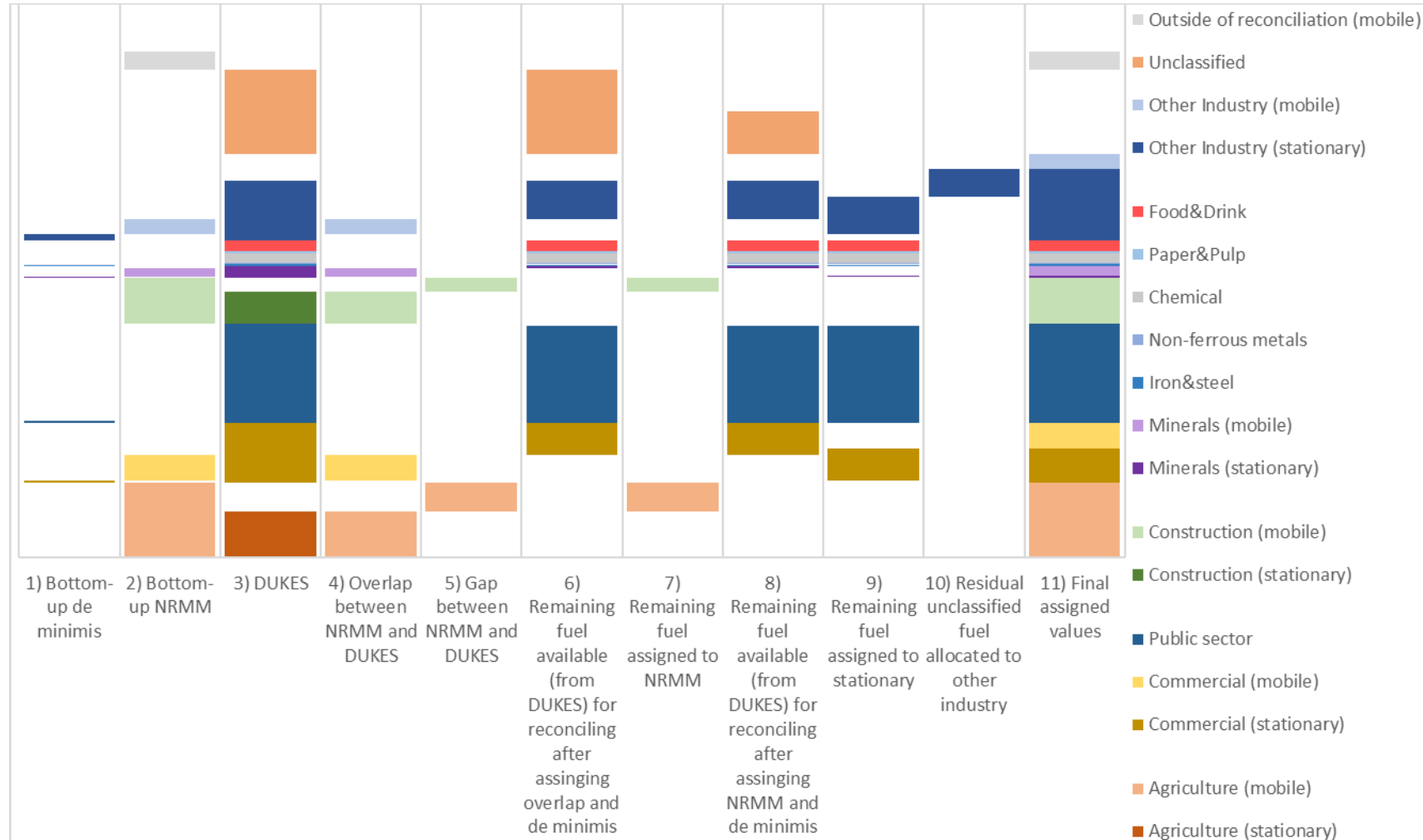
Machinery type	DUKES end use category to map to	Comments and rationale	Where data are reported
Generators	Other industry	Likely used across almost all sectors to some degree, and there are no clear sectors which would dominate use. These are allocated to 'other industry' in the absence of a clear sector to allocate to.	1A2gvii
Mining and Quarrying	Minerals	We would expect almost all gas oil used in the minerals sector to be for use in mining and quarrying machinery, and this equipment is unlikely to be captured in any other sectors.	1A2gvii
Other Industry	Other industry	This category includes a very wide range of machinery, typically with small engines (such as <37kW). It would not add much value to look into these machinery types on a case-by-case basis to better allocate them to end users, so instead these are simply allocated to 'other industry'.	1A2gvii
Refrigerated Transport	Commercial	<i>This is specifically transport refrigeration units which are independently powered; this does not include the main engine for modes of transport carrying transport refrigeration units.</i>  While many sectors such as food and drink industries will use this equipment, we expect the largest users to be retailers and distributors, which would be considered 'commercial' by the energy statistics team.	1A2gvii
Sea Ports	National Navigation	National navigation in DUKES is defined as "Fuel oil and gas/diesel oil delivered, other than under international bunker contracts, for fishing vessels, UK oil and gas exploration and production, coastal and inland shipping and for use in ports and harbours". Therefore, this sector would be expected to include fuel use for port machinery, and this equipment is unlikely to be captured in any other sectors.	1A2gvii
Waste	Commercial	The UK energy stats team indicated that waste management organisations would be categorised as 'commercial' in DUKES. This equipment is unlikely to be captured in any other sectors.	1A2gvii

Steps 2-6 of this process are illustrated in the below two figures, which presented the quantities of fuel in each stage of the reconciliation calculations. Note that:

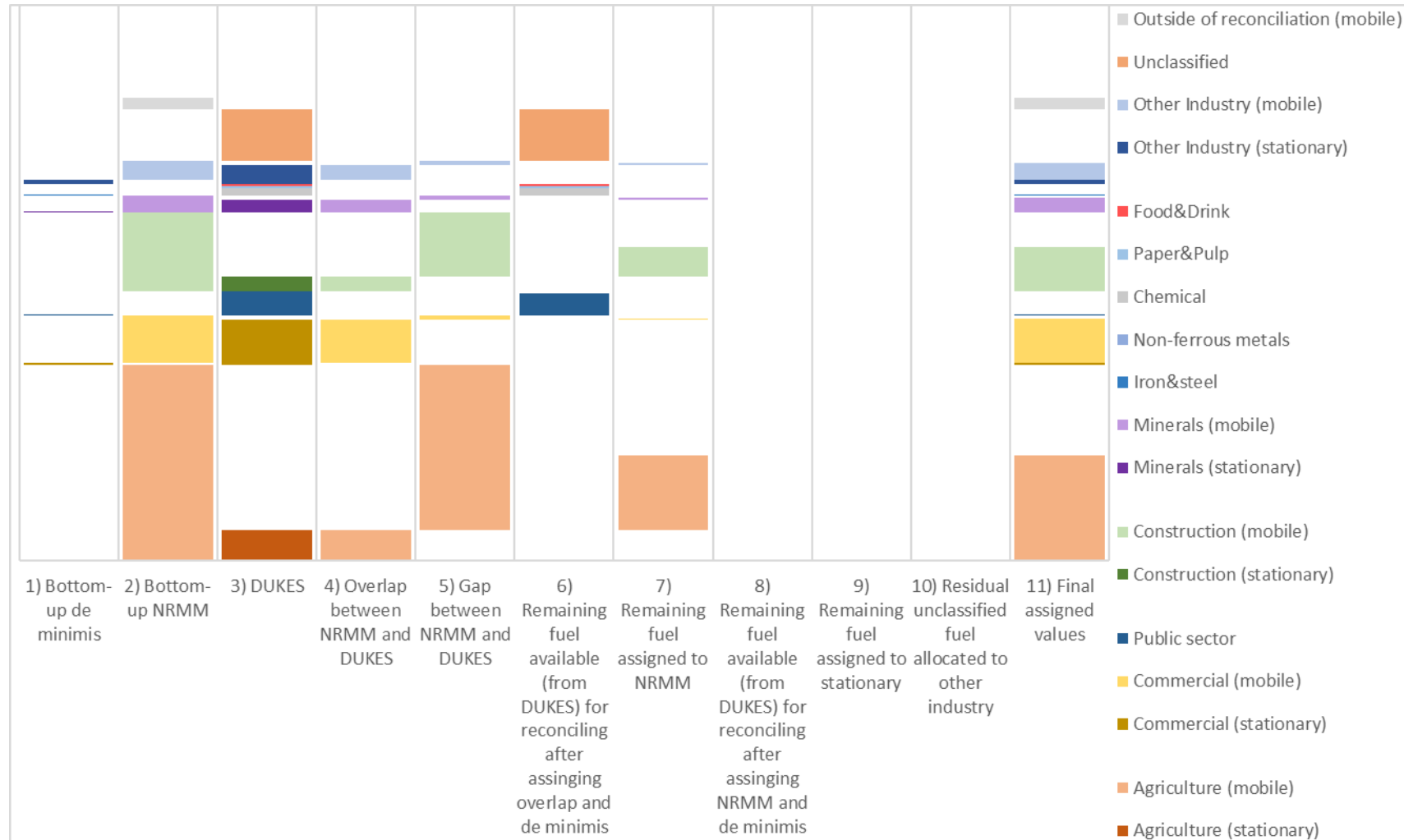
- The first three columns represent the input data, the final column the final allocation used, and the other columns present the calculations done to determine how fuel is allocated;
- The first column 'Bottom-up de minimis' is equivalent to step 2 in the reconciliation process described above;
- The fourth column 'Overlap between NRMM and DUKES' is equivalent to step 3 in the reconciliation process described above;
- The seventh column 'remaining fuel assigned to NRMM' is equivalent to step 4 in the reconciliation process described above;
- The ninth column 'remaining fuel assigned to stationary' is equivalent to step 5 in the reconciliation process described above;
- The tenth column 'residual unclassified fuel allocated to other industry' is equivalent to step 6 in the reconciliation process described above;

- When you sum up the columns for steps 2-6, you will have the final allocations presented in the final column;
- In most cases the colour scheme has pairs where the paler bars relate to mobile combustion, and the darker bars relate to stationary combustion;
- At the top of the third column 'DUKES', is 'unclassified' fuel. This is free for the inventory team to reallocate to whichever sector our bottom-up estimates indicate are underestimated by DUKES; and,
- At the top of second column bottom-up NRMM' are port machinery, which are excluded from the reconciliation process.

**Figure A 4.1 Gas oil reconciliation visual representation: example where there is enough fuel to allocate to bottom-up NRMM estimates**



**Figure A 4.2 Gas oil reconciliation visual representation: example where there is not enough fuel to allocate to bottom-up NRMM estimates**





In addition to off-road mobile machinery, gas oil allocations are also required for other sources such as vessels on the UK’s inland waterways (Walker et al, 2011). Research into fuel use on inland waterways indicates that not all vessels with diesel engines use gas oil, but that some also use road diesel; this may also apply to other off-road machinery sources, especially those that consume small amounts of fuel on an irregular basis, e.g. for private or recreational use rather than commercial use. There are also inconsistencies in terminology used to define types of fuel; the research indicated that the terms “gas oil”, “red diesel” and “diesel” are used interchangeably by fuel suppliers and consumers and this confuses the situation when considering fuel allocations across different sectors.

As with fuel oil, the introduction of the results of a major research project into the shipping sector in the 2018 submission, whereby Automatic Identification System (AIS) data was used to calculate shipping movements along the coast of the UK and the Crown Dependencies, however suggested that gas oil consumption reported by DUKES for national navigation is an underestimate. As a result, total gas oil use (not including DERV) deviates from DUKES as any further consumption in the national navigation sector are considered additional to DUKES and are not reconciled elsewhere in the inventory. Note that in DUKES, port machinery fuel use is included as part of national navigation, and therefore, similar to the estimates of gas oil use for shipping, the bottom-up estimates for fuel consumption by port machinery also deviates from DUKES and are not reconciled elsewhere in the inventory.

**Table A 4.2.6** below summarised the DUKES and GHGI allocations for the latest inventory year.

**Table A 4.2.6 Fuel reconciliation: Gas oil use in latest year (Mtonnes)**

Dukes Category	Activity (TJ net)	GHGI	IPCC Sector	Activity (TJ net)	Difference	Comment
Major power producers	0.058	Power Stations	1A1ai	0.059	-0.001	
Autogenerators	0.028	Autogenerators (inc. exports to grid)	1A2b	-	0.028	Fuel reallocated to iron and steel works and other industries on the basis of data provided by BEIS
Oil gas extraction	0.533	Upstream Oil/Gas production	1A1ciii	0.533	0.000	
Petroleum refineries	-	Refineries - combustion	1A1b	-	-	
Other industries	1.487	Other industrial combustion	1A2gviii	0.069	1.419	Calculated as a residual to allow bottom up estimates to be used in other categories; local datasets used for CD consumption
Iron and steel	0.004	Iron and steel - combustion plant	1A2a	0.003	0.001	Data provided by operators
Non ferrous metals	0.007	Non-ferrous metal (combustion)	1A2b	-	0.007	
		Cement processes	1A2f	0.005	-	Data provided by operators
Chemicals	0.080	Chemicals (combustion)	1A2c	-	0.080	
food beverages	0.041	Food & drink, tobacco (combustion)	1A2e	-	0.041	
Paper printing	0.031	Pulp, Paper and Print (combustion)	1A2d	-	0.031	

Dukes Category	Activity (TJ net)	GHGI	IPCC Sector	Activity (TJ net)	Difference	Comment
		Off-road industrial machinery	1A2gvii	1.541	-	
		Aircraft - support vehicles	1A3eii	0.041	-	Inventory Agency estimates. No such DUKES categories.
TOTAL industry (inc. heat generation)	1.650	TOTAL industry	∑1A2, 1A3eii	1.618	0.031	
Road	21.727	Road transport		21.593	0.134	Reduced to offset consumption from off-road DERV applications
Rail	0.506	Rail transport	1A3c	0.477	0.029	Inventory Agency estimates
National navigation	0.584	Inland and small vessels, and domestic shipping	1A3d	1.229		
		Fishing vessels	1A4ciii	0.140		
		Naval shipping	1A5b	0.164		
TOTAL National navigation	0.584	TOTAL National navigation		1.533	-0.949	Bottom-up shipping methodology implies more use of gas oil than in DUKES
Marine bunkers	1.332	Marine bunkers	Memo item	1.332	0.000	
Domestic	0.123	Domestic combustion	1A4bi	0.123	0.000	
		Off-road domestic machinery	1A4bii	0.011	-0.011	Inventory Agency estimates. No such DUKES category.
Public Administration	0.277	Public sector combustion	1A4ai	0.024	0.253	Fuel use offset to account for to inventory estimates of various off-road machinery and vehicles
Commercial	0.513	Miscellaneous industrial/commercial combustion	1A4ai	0.050	0.702	Fuel use offset to account for to inventory estimates of various off-road machinery and vehicles
Miscellaneous	0.239					
Agriculture	0.374	Agriculture (stationary combustion)	1A4ci	-	0.374	Fuel use offset to account for to inventory estimates of various off-road machinery and vehicles
		Agriculture (mobile combustion)	1A4cii	1.503	-1.503	Inventory Agency estimates
TOTAL	27.944	TOTAL		28.896	- 0.952	Overall the GHGI reports more gas oil use than DUKES, due to the shipping research and fuel use in OTs.

Notes: Rows are shaded to help illustrate reconciliation between sectors

#### A 4.2.1.5 Petroleum gases

For petroleum gases (LPG, OPG), the total fuel use in the inventory is greater than the national statistics in several years, to reflect information from other sources (such as EU ETS data) that indicate potential under-reports in the UK energy statistics. These modifications to the energy

balance are set out in **Table A 4.2.7**. They mostly relate to refineries, use of feedstock as fuel in the petrochemicals sector, and fuel use for upstream oil and gas production.

**Table A 4.2.7 Fuel reconciliation: Use of Petroleum Gases in the latest year (Mt)**

DUKES Category	Activity (Mt)	GHGI	IPCC Sector	Activity (Mt)	Difference	Comment
<b>Liquefied Petroleum Gas (LPG) – in DUKES this fuel is reported as propane and butane</b>						
Petroleum refineries	0.004	Refineries - combustion	1A1b	0.004	0.000	Refinery (and on-site refinery autogen) AD derived from EU ETS and deviates from DUKES
Heat generation	-				0.000	Several re-allocations from DUKES to accommodate other data. Overall a higher GHGI allocation to industry, lower allocation to 'other' sources such as commercial, but reconciles to DUKES across industry and 'other' combustion, together.
Iron and steel	0.000	Iron and steel - combustion plant	1A2a	0.000	0.000	
Food, beverages, etc.	0.049				0.000	
Other industry	0.320	Other industrial combustion	1A2gviii	0.797	0.000	
Agriculture	0.081	Agriculture - stationary combustion	1A4ci	-		
Commercial / Miscellaneous	0.313	Miscellaneous/Commercial combustion	1A4ai	-		
Domestic	0.200	Domestic combustion	1A4bi	0.216	0.000	
Public administration	0.017	Public sector combustion	1A4bi	IE	0.000	
Subtotal	0.610	Subtotal		0.216	0.394	
Road transport	0.058	Road transport	1A3bv	0.059	-0.001	
<b>TOTAL (LPG)</b>	<b>1.042</b>	<b>TOTAL (LPG)</b>		<b>1.077</b>	<b>-0.035</b>	
<b>Other Petroleum Gases (OPG) – includes Refinery Fuel Gas (RFG). In DUKES, reported as Ethane, Other gases and Naphtha.</b>						
Petroleum refineries	1.604	Refineries - combustion	1A1b	1.960	-0.356	Refinery (and on-site refinery autogen) AD derived from EU ETS and deviates from DUKES
Autogeneration	0.134					
Subtotal	1.738	Subtotal		1.960	-0.222	
						Refinery (and on-site refinery autogen) AD derived from EU ETS and

DUKES Category	Activity (Mt)	GHGI	IPCC Sector	Activity (Mt)	Difference	Comment
						deviates from DUKES
Other transformation	0.178				0.178	Backflows from petrochemicals to refineries for further processing so not emissive and not needed in the inventory
		Chemicals (combustion)	2B8g	1.019	-1.019	Use of process off-gases as fuel in petrochemical plant are added to the GHGI, from EU ETS reporting. In DUKES these materials are reported (correctly) as Non Energy Use process feedstocks, other than a small component of naphtha reported as unclassified industry use.
<b>TOTAL (OPG)</b>	<b>2.719</b>	<b>TOTAL (OPG)</b>		<b>2.558</b>	<b>0.161</b>	

Notes: Sequences of shaded rows indicate categories which are grouped for purposes of data reconciliation, and should be considered together.

1 Mtherm = 105.51 TJ

### A 4.3 REPORTING ON CONSISTENCY WITH ENERGY DATA

The UK conducts an annual analysis of how the GHGI reference approach compares to what the UK energy statistics team submit to the IEA. This acts a QA step for the UK GHGI balance, and aids transparency of why these data might differ for different reporting obligations. The results of the analysis for the latest year are summarised in the table below.

**Table A 4.3.1 Comparison of UK GHGI reference approach to IEA returns' apparent consumption (for 2021)**

FUEL TYPES			Apparent consumption reported in GHG inventory (TJ)	Apparent consumption using data reported by the IEA (TJ)	Absolute difference (TJ)	Relative difference %	Explanations for differences
Liquid fossil	Primary fuels	Crude oil	1,929,413.8	1,929,354.1	59.7	0.0%	
		Orimulsion	0.0	0.0	0.0	N/A	
		Natural gas liquids	116,775.1	119,706.9	-2,931.8	-2.5%	IPCC default NCV used for GHGI RA calculations, which differs from the NCV used in the calculations that provide an estimate for the IEA return by about 2.5%.
	Secondary fuels	Gasoline	-228,159.4	-231,522.8	3,363.4	-1.5%	Imports are expected to be higher in the GHGI due to the inclusion of Overseas territories, which won't be included in the IEA return. In 2021 the Overseas territories imported 3,445 TJ of gasoline, which explains almost the entirety of this difference.
		Jet kerosene	-9,795.9	-19,313.0	9,517.1	-97.2%	Imports are expected to be higher in the GHGI due to the inclusion of Overseas territories, which won't be included in the IEA return. The scope of international bunkers is also different, as the IEA return will exclude Overseas Territories as part of the UK's coverage for the IEA return, but the OTs are included in the UK's submission. This difference is likely exaggerated this year due to large changes in the aviation sector's behaviour due to the pandemic impacting the different approaches to estimating international / domestic splits that are used for IEA and GHGI reporting.
		Other kerosene	31,884.8	31,757.7	127.1	0.4%	Imports are expected to be higher in the GHGI due to the inclusion of Overseas territories, which won't be included in the IEA return. In 2021 the Overseas territories imported 118 TJ of other kerosene, which explains almost the entirety of this difference.

FUEL TYPES		Apparent consumption reported in GHG inventory (TJ)	Apparent consumption using data reported by the IEA (TJ)	Absolute difference (TJ)	Relative difference %	Explanations for differences
	Shale oil	0.0	0.0	0.0	N/A	
	Gas/diesel oil	413,721.3	400,449.7	13,271.6	3.2%	Imports are expected to be higher in the GHGI due to the inclusion of Overseas territories, which won't be included in the IEA return. In 2021 the Overseas territories imported 13,090 TJ of Gas/diesel oil, which explains almost the entirety of this difference.
	Residual fuel oil	-100,380.1	-105,683.7	5,303.7	-5.3%	Imports are expected to be higher in the GHGI due to the inclusion of Overseas territories, which won't be included in the IEA return. In 2021 the Overseas territories imported 4,800 TJ of residual fuel oil, which explains most of this difference. In addition to this, the boundary of what is considered international journeys or not differ due to journeys between the UK and OTs being considered domestic under UNFCCC scope.
	Liquefied petroleum gases (LPG)	-11,812.6	-12,786.9	974.3	-8.2%	Imports are expected to be higher in the GHGI due to the inclusion of Overseas territories, which won't be included in the IEA return. In 2021 the Overseas territories imported 886 TJ of LPG, which explains most of this difference.
	Ethane	54.0	0.0	54.0	100.0%	Suspected that this is a result of rounding in the IEA report, where these small values might be rounded to zero.
	Naphtha	-12,270.8	-12,354.1	83.3	-0.7%	
	Bitumen	44,469.2	43,760.6	708.6	1.6%	0.7% difference in NCV. The rest of the difference appears to be a difference in stock change between the IEA return and the UK energy statistics.
	Lubricants	-2,118.8	-3,016.1	897.3	-42.3%	The difference appears to be a difference in stock change between the IEA return and the UK energy statistics.
	Petroleum coke	-4,712.2	-4,783.9	71.7	-1.5%	
	Refinery feedstocks	77,560.0	75,520.8	2,039.2	2.6%	Mostly explained by a 2.4% difference in choice of NCV.
	Other oil	-26,194.6	-27,359.2	1,164.6	-4.4%	Mostly explained by a 3.3% difference in choice of NCV. There is also a small quantity of additional fuel estimated to be imported for use in OTs in the GHGI compared to the IEA scope.

FUEL TYPES			Apparent consumption reported in GHG inventory (TJ)	Apparent consumption using data reported by the IEA (TJ)	Absolute difference (TJ)	Relative difference %	Explanations for differences
	Other liquid fossil		0.0	0.0	0.0	N/A	
	Liquid fossil total		<b>2,218,433.9</b>	<b>2,183,730.1</b>	<b>34,703.8</b>	<b>1.6%</b>	<b>Most of the difference can be put down to additional imports of fuel associated with OT consumption in the GHGI compared to the IEA, with additional differences around differences in bunkers fuel allocations and choices of NCVs.</b>
Solid fossil	Primary fuels	Anthracite	16,988.9	0.0	16,988.9	100.0%	The submission to the IEA doesn't differentiate between Anthracite and other bituminous coal.
		Coking coal	72,297.2	72,446.9	-149.7	-0.2%	
		Other bituminous coal	109,103.2	128,925.1	-19,821.9	-18.2%	The submission to the IEA doesn't differentiate between Anthracite and other bituminous coal. Additionally, the weighted NCVs used differ between the IEA return and the UK GHGI reference approach.
		Sub-bituminous coal	0.0	0.0	0.0	N/A	
		Lignite	0.0	0.0	0.0	N/A	
		Oil shale and tar sand	0.0	0.0	0.0	N/A	
	Secondary fuels	BKB and patent fuel	7.8	-28.3	36.1	464.6%	Suspected rounding differences in the small numbers being reported.
		Coke oven/gas coke	38,362.1	38,352.6	9.5	0.0%	
		Coal tar	0.0	0.0	0.0	N/A	
	Other solid fossil		0.0	0.0	0.0	N/A	
	Solid fossil totals		<b>236,759.2</b>	<b>239,696.3</b>	<b>-2,937.1</b>	<b>-1.2%</b>	Primarily the impact of differences in weighted NCVs for bituminous coals.
Gaseous fossil		Natural gas (dry)	2,764,071.3	2,754,907.2	-9,164.1	0.33%	Primarily driven by a more precise gross-net value used in the GHGI based on industry data, which is 0.3% different.
Other gaseous fossil			0.0	0.0	0.0	N/A	

FUEL TYPES			Apparent consumption reported in GHG inventory (TJ)	Apparent consumption using data reported by the IEA (TJ)	Absolute difference (TJ)	Relative difference %	Explanations for differences
Gaseous fossil totals			2,764,071.3	2,754,907.2	-9,164.1	0.33%	Primarily driven by a more precise gross-net value used in the GHGI based on industry data, which is 0.3% different.
	Waste (non-biomass fraction)		74,657.1	59,943.0	14,714.1	19.7%	There is normally a ~5% or so difference in the CV assumptions between the GHGI and the IEA, however this is exaggerated this year due to recalculations being made to industrial waste reported to the IEA which are yet to be implemented in published UK energy statistics used for the GHGI.
Other fossil fuels			0.0	0.0	0.0	N/A	
Peat			72.8	0.0	72.8	100.0%	The UK energy statistics team do not estimate peat balances, the GHGI make this estimate via alternative data sources.
Total			5,293,994.2	5,281,566.4	12,427.8	0.2%	<b>There are 2 key reasons for differences:</b> <b>1) Geographical coverage, the UK GHGI includes OTs, which are not included in the IEA returns.</b> <b>2) Differences in conversion factors used to convert from a mass basis to an energy basis or a gross to net basis.</b> <b>3) Recalculations in the IEA data which is yet to be implemented in published UK energy statistics</b>



# **ANNEX 5: Additional Information to be Considered as Part of the Annual Inventory Submission**

## **A 5.1 ANNUAL INVENTORY SUBMISSION**

No additional information.

# ANNEX 6: Comparison of Inventory and Emissions Estimated using Atmospheric Observations

This Annex describes the verification of the reported UK emissions through comparison with UK emissions estimated through the use of atmospheric observations and modelling.

## A 6.1 MODELLING APPROACH USED FOR COMPARISON WITH THE UK GHGI

Comparison of the UK GHGI (Greenhouse Gas Inventory) with emission estimates calculated using atmospheric observations is considered to be best practice by the UNFCCC as it allows for an independent assessment of the GHG emissions from the UK using a comprehensively different approach. Significant differences in the emissions estimated using the two methods are a means of identifying areas worthy of further investigation, for example as occurred with a re-assessment of the emissions of HFCs for refrigeration.

In order to provide a comparison to the UK GHGI, BEIS (UK government department of Business, Energy and Industrial Strategy) supported the establishment and maintenance of a high-quality remote observation station at **Mace Head (MHD)** on the west coast of Ireland as part of the Advanced Global Atmospheric Gases Experiment (AGAGE) (Prinn et al., 2018). The station reports high-frequency concentrations of the key greenhouse gases and is under the supervision of Prof. Simon O'Doherty of the University of Bristol (O'Doherty et al. 2004, 2014, Stanley et al. 2018, Stavert et al. 2019).

BEIS extended the measurement programme in 2012 with three new tall tower stations across the UK, collectively called the UK DECC (Deriving Emissions linked to Climate Change) network: **Tacolneston (TAC)** near Norwich; **Ridge Hill (RGL)** near Hereford; and **Tall Tower Angus (TTA)** near Dundee, Scotland (decommissioned in 2015). Two additional stations, **Heathfield (HFD)** in Southern England and **Bilsdale (BSD)** in North Yorkshire, were established through the NERC GAUGE (Greenhouse gAs UK and Global Emissions) programme. BSD replaced TTA in 2015 in the UK DECC network and is funded by DESNZ (formerly BEIS). A fire at BSD in August 2021 destroyed the tower and measurements have therefore been discontinued until a replacement tower is available. HFD is supported by the National Physical Laboratory (NPL). Methane (CH<sub>4</sub>), carbon dioxide (CO<sub>2</sub>), nitrous oxide (N<sub>2</sub>O) and sulphur hexafluoride (SF<sub>6</sub>) are measured at all stations across the UK DECC network. The hydrofluorocarbons (HFCs) and perfluorocarbons (PFCs) are measured at MHD and TAC, and nitrogen trifluoride (NF<sub>3</sub>) is only measured at MHD within the DECC network.

With permission of the data providers, observations were also obtained from:

- **Carnsore Point (CSP)** on the east coast of Ireland (2005-2010), funded by the Irish Environmental Protection Agency (F-gases).
- **Weybourne (WAO)** in East Anglia, England (2013-present) ICOS site supported by the University of East Anglia and the National Centre for Atmospheric Sciences (CH<sub>4</sub>).

- **Cabauw (CBW)** in the Netherlands (1993-2019) supported by the Netherlands Organisation for applied scientific research (TNO), funded by the Dutch Ministry of Infrastructure and Water Management. Glass flasks are analysed at the University of Bristol (CH<sub>4</sub>, F-gases).
- **Jungfrauoch (JFJ)** in the Swiss Alps (2007-present) supported by the Federal Office for the Environment (FOEN) through the project HALCLIM/CLIMGAS-CH, by the International Foundation High Altitude Research Stations Jungfrauoch and Gornergrat (HFSJG), and by the Swiss Federal Laboratories for Materials Science and Technology (Empa) (CH<sub>4</sub>, F-gases).
- **Monte Cimone (CMN)** in the Italian Apennine mountains (2007-present) supported by the University of Urbino (CH<sub>4</sub>, F-gases).
- **Taunus (TOB)** in central Germany (2013-present) supported by the Goethe University Frankfurt (F-gases).
- **Trainou (TRN)** in France (2007-present) ICOS site operated by Laboratoire des Sciences du Climat et de l'Environnement (LSCE) (CH<sub>4</sub>).
- **Lutjewad (LUT)** in The Netherlands (2007-present) ICOS site operated by University of Groningen - Centre for Isotope Research (RUG-CIO), University of Groningen (RUG) (CH<sub>4</sub>).

For the global hemispheric concentration analysis, data were kindly provided from the **Kennaook/Cape Grim observatory (CGO)** in Tasmania, Australia by CSIRO (The Commonwealth Scientific and Industrial Research Organisation, an Australian Government agency).

The Met Office, under contract to DESNZ, employs the Lagrangian dispersion model NAME (Numerical Atmospheric dispersion Modelling Environment) (Ryall et al. 1998, Jones et al. 2007) driven by three-dimensional modelled meteorology to interpret the observations. NAME determines the history of the air arriving at each station at the time of each observation. Estimates of UK emissions are made by firstly estimating the underlying background trend (Northern Hemisphere, mid-latitude, atmospheric concentrations with the short-term impact of regional pollution removed from the data) and secondly by modelling the impact of where the air has passed over on route to the observation stations at a regional scale. A methodology called Inversion Technique for Emission Modelling (InTEM) has been developed that uses a minimisation technique, Non-Negative Least Squares (NNLS) (Lawson and Hanson, 1974), to determine the emission distribution that most accurately reproduces the observations (Manning et al. 2003, 2011, 2021 and Arnold et al. 2017).

For each reported gas, the Northern (estimated using observations from MHD) and Southern (estimated using observations from CGO) Hemisphere background concentrations and the UK emission estimates are presented. InTEM uses all of the available observations. Two-year inversion windows are used up until 2013 due to the paucity of UK observations prior to this year. Each inversion is performed for a two-year period and then the period is incremented by one-year e.g. 1989 – 1990, 1990 – 1991 etc., from which a mean for each year is estimated. From 2013, with the additional data from the other stations (principally TAC), the inversion time window is shortened to one year or smaller (1 month for CH<sub>4</sub>, N<sub>2</sub>O and SF<sub>6</sub> as all of the DECC network stations measure these gases). For CH<sub>4</sub>, 2-month windows were used from 2007-2013 due to the availability of additional European observations during this time.

The geographical spread of the UK DECC (and other stations) network allows the spatial distribution of the emissions across the UK to be better constrained by InTEM. The InTEM

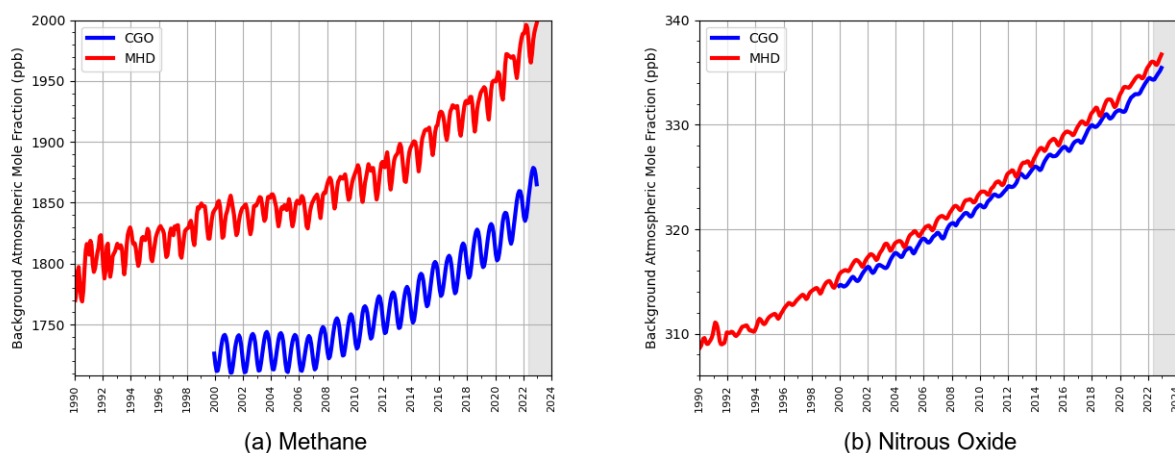
estimates of UK emissions using the atmospheric observations are compared to the reported GHGI estimates. For each gas the InTEM estimated geographical distribution is presented as an average for 2019-2022. For CH<sub>4</sub> and N<sub>2</sub>O these are shown as seasonal averages for 2019-2022. The time-series of UK emissions from 1990 are given showing the comparison between the GHGI and InTEM (2-year and 1-year or monthly) estimates.

The uncertainty of the InTEM estimates are calculated through the Bayesian framework. The GHGI uncertainties have been linearly interpolated between the reported 1990 and 2021 Approach 2 uncertainty values given in the 2022 submission of the UK NIR. As the values in the GHGI should represent a 95% confidence interval, the uncertainties have been halved so they are comparable to ±1σ, consistent with the error bars presented in this chapter. The most recent GHGI uncertainty assessment is not completed in time to allow for inclusion in the analysis presented in this chapter, but as the assessments for uncertainty by gas do not generally change substantially between submissions, the use of the previous year’s GHGI uncertainty values is a good approximation.

All of the comparisons have been made in units of CO<sub>2</sub>-equivalence using global warming potentials (GWP) over a 100-year timeframe (IPCC 5<sup>th</sup> assessment), consistent with the values used throughout this document.

## A 6.2 METHANE

**Figure A 6.1** Background Northern Hemisphere monthly concentrations of (a) CH<sub>4</sub>, and (b) N<sub>2</sub>O, estimated from MHD, Ireland observations are shown in red, and background Southern Hemisphere monthly concentrations from CGO, Tasmania are shown in blue. Grey shading represents unratified data.



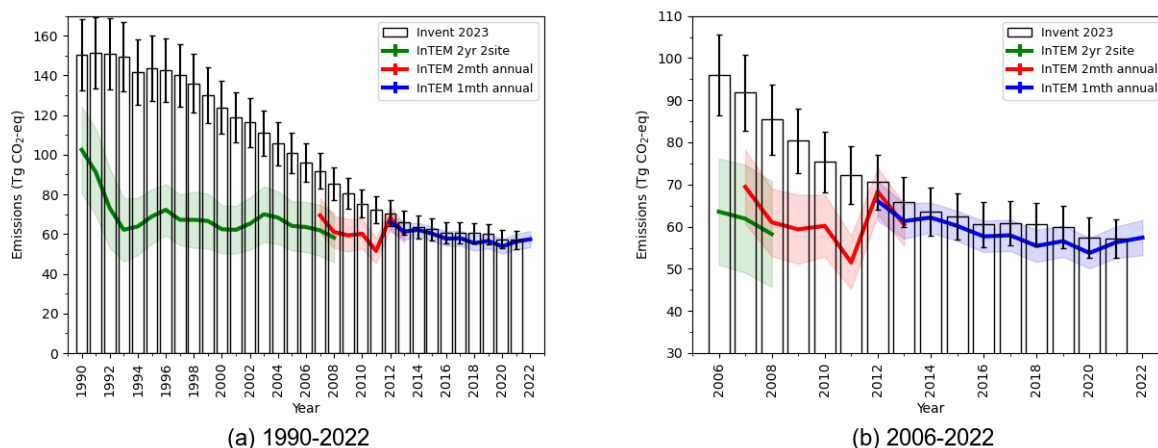
**Figure A 6.1** (a) shows the background atmospheric concentration of CH<sub>4</sub> from 1990 onwards. As with all of the background plots for each different gas, it shows how the overall atmospheric concentration of the gas in question is changing as a result of global emissions and atmospheric loss processes. For CH<sub>4</sub>, the underlying background trend is positive. In 2022, the Northern Hemisphere (NH) concentration grew by 15.2 ppb, the SH by 18.4 ppb.

The CH<sub>4</sub> emission estimates made for the UK using the InTEM methodology are compared to the GHGI emission estimates for the period 1990 onwards and shown in **Figure A 6.2**. It is important to note that although the UK GHGI CH<sub>4</sub> emissions are estimated to have fallen since 1990, the

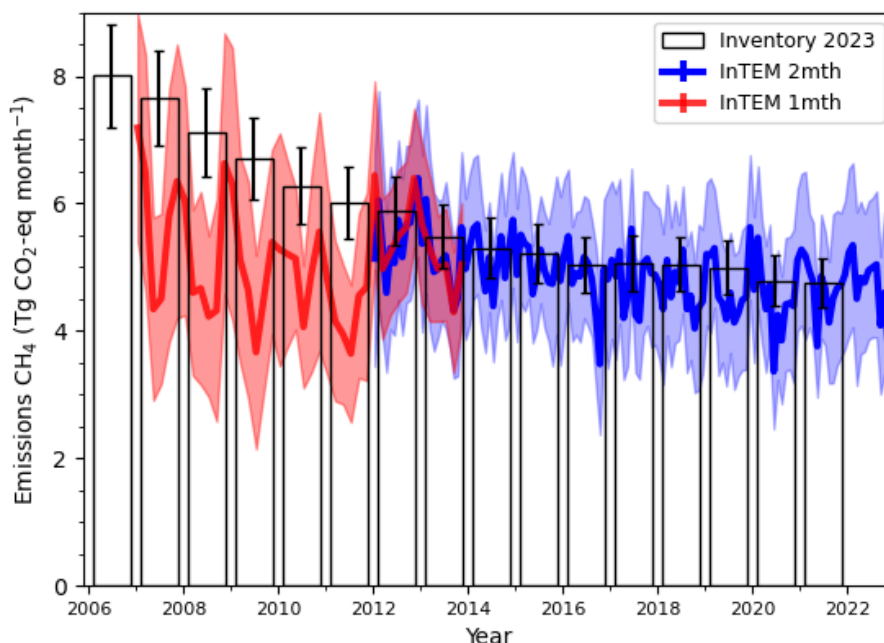
global atmospheric concentration of CH<sub>4</sub> has increased, indicating that global emissions of CH<sub>4</sub> are still outperforming the global natural removal of CH<sub>4</sub> from the atmosphere.

CH<sub>4</sub> has a natural (biogenic) component and it is estimated that 22% of the annual global emission is released from wetlands (Nilsson et al. 2001). Usually, natural emissions are strongly dependent on a range of meteorological factors such as temperature and also growth and decay cycles. Such non-uniform emissions will add to the uncertainties in the InTEM modelling, although in northwest Europe the natural emissions are thought to be small compared to the anthropogenic emissions (<5%, Bergamaschi *et al* 2005). Due to the relatively strong local (within 20km) influence of emissions at some of the stations, observations taken when local emissions are thought to be significant (poor atmospheric mixing, low boundary layer heights, low wind speeds, stable atmospheres) have been removed from the InTEM analysis.

**Figure A 6.2** Verification of the UK emission inventory estimates for CH<sub>4</sub> in Tg CO<sub>2</sub>-eq yr<sup>-1</sup> (a) from 1990 and (b) from 2006. GHGI estimates are shown in black. InTEM 2-site 2-year estimates are shown in green ( $\pm 1\sigma$ ). InTEM full network, 1-month annualised, estimates are shown in blue ( $\pm 1\sigma$ ). InTEM 7-site, 2-month annualised, estimates are shown in red ( $\pm 1\sigma$ ).

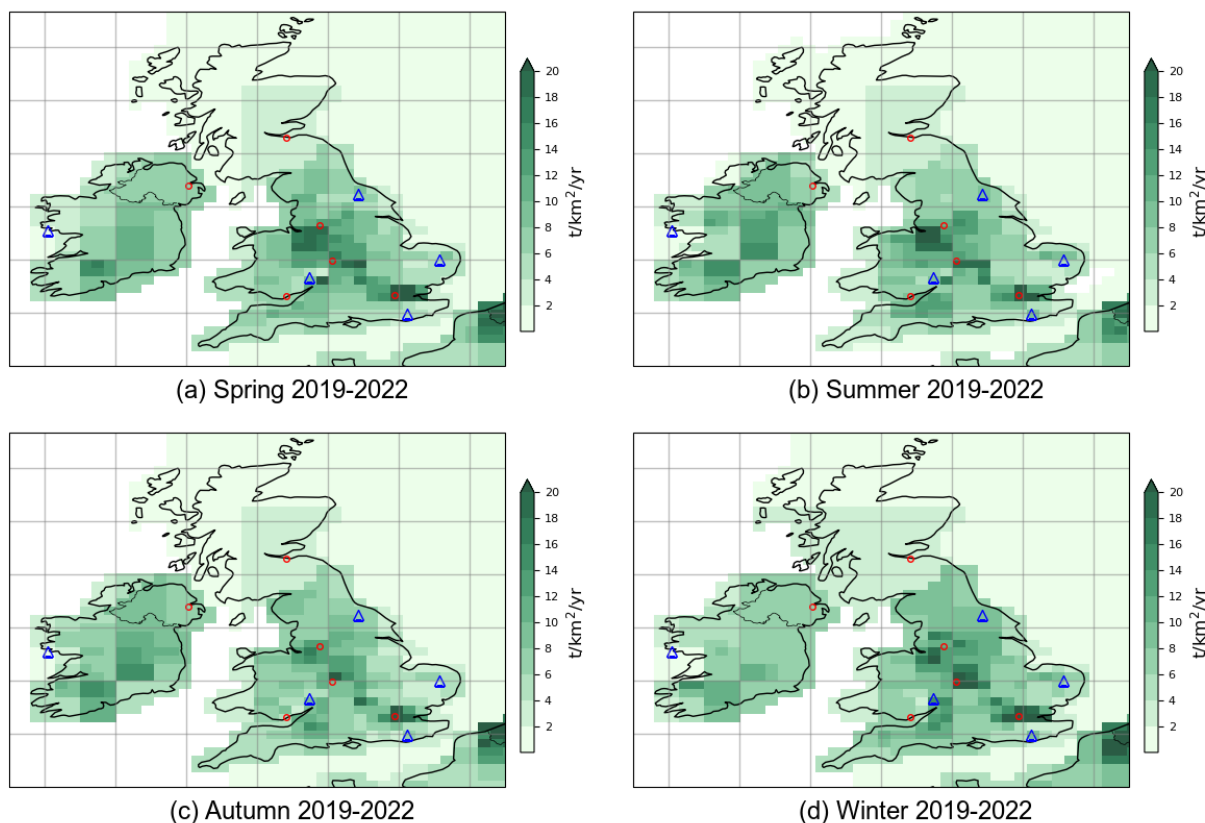


**Figure A 6.3** Verification of the UK emission inventory estimates for CH<sub>4</sub> in Tg CO<sub>2</sub>-eq month<sup>-1</sup> from 2006. GHGI estimates are shown in black. InTEM 2-month estimates are shown in red ( $\pm 1\sigma$ ). InTEM 1-month estimates are shown in blue ( $\pm 1\sigma$ ).



The UK GHGI trend is monotonically downwards from 1990 whereas, in contrast the InTEM trend is relatively flat from 1993 onwards. Prior to 2007 the InTEM estimates are based only on MHD and CBW observations. The reasons for the large discrepancy in the 1990s and 2000s are not known and given the paucity of observations it is difficult to unpick further. The large drop in the GHGI is estimated to be dominated by a reduction in waste and coal mining emissions. From 2007 observations from TTA, JFJ, CMN, LUT and TRN become available. From 2012, observations from TAC, RGL, HFD, BSD and WAO from the UK DECC network are available. The InTEM estimates show a modest ( $-1.5\% \text{ yr}^{-1}$ ) annual decline 2013-2021, similar to the GHGI ( $-1\% \text{ yr}^{-1}$ ) over the same period. The InTEM 1-month estimates (**Figure A 6.3**) using the full network of observations do not show a strong seasonal cycle in UK CH<sub>4</sub> emissions, whereas the 2-month InTEM estimates 2007-2011 do. **Figure A 6.4** shows the geographical distribution of CH<sub>4</sub> emissions (average over 2019-2022) as estimated by InTEM per season, Winter (Dec-Feb), Spring (Mar-May), Summer (Jun-Jul) and Autumn (Sep-Nov), each of the plots show elevated emissions in highly populated areas. Scotland is poorly resolved due to the paucity of observations after 2015.

**Figure A 6.4** Four-year average CH<sub>4</sub> InTEM emission estimates (kg km<sup>-2</sup> yr<sup>-1</sup> of gas) 2019-2022 by season: (a) Spring (b) Summer (c) Autumn and (d) Winter. The observation stations are shown as blue triangles. Major cities are shown as red circles.

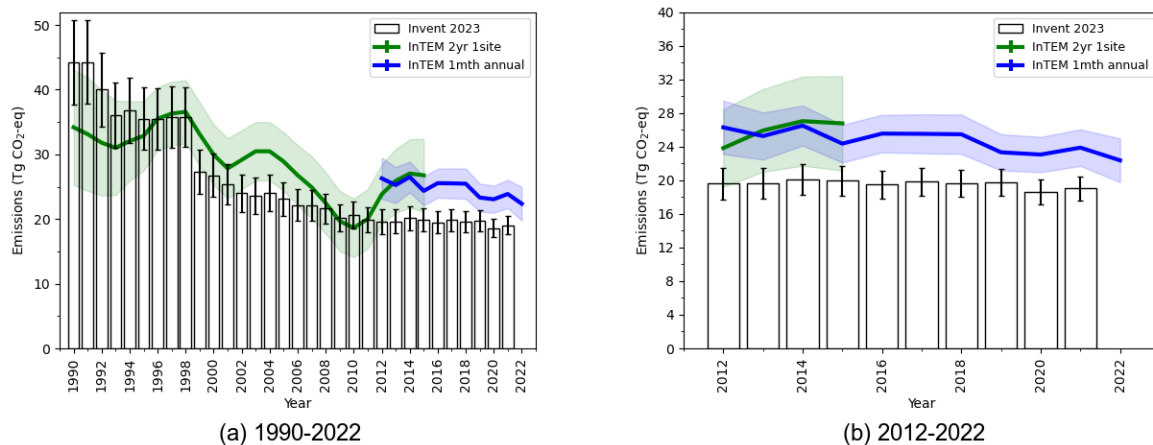


### A 6.3 NITROUS OXIDE

**Figure A 6.1** (b) shows the Hemisphere background atmospheric concentration of N<sub>2</sub>O from 1990 onwards. The background trend is monotonic and positive. The Northern Hemispheric background concentration increased by 1.3 ppb in 2022.

The main activities in Europe resulting in the release of N<sub>2</sub>O are: agricultural practices resulting in emissions from soils (~75%), industrial processes (~4%), energy (~10%), waste (5%) and LULUCF (6%) (UNFCCC 2020 emission estimates for EU+UK). The amount emitted from soils has significant uncertainty and has a diurnal and seasonal release cycle. It is driven by the availability of nitrogen, temperature and the soil moisture content.

**Figure A 6.5** Verification of the UK emission inventory estimates for N<sub>2</sub>O in Tg CO<sub>2</sub>-eq yr<sup>-1</sup> (a) from 1990 and (b) from 2012. GHGI estimates are shown in black. InTEM 1-site, 3-year estimates are shown in green (±1σ), InTEM full network, 1-month, annualised, estimates are shown in blue (±1σ).

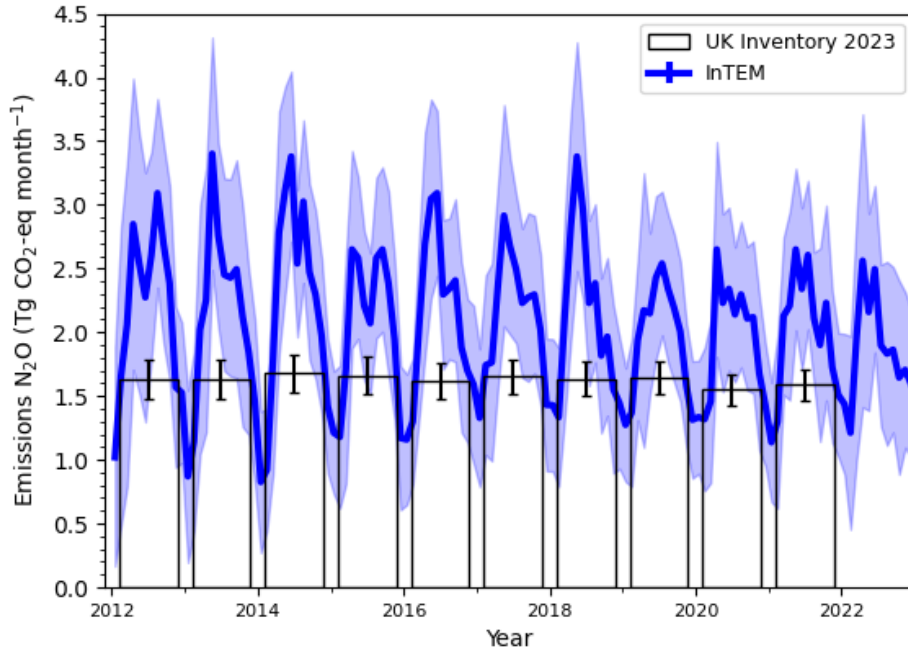


**Figure A 6.5** shows the InTEM and GHGI emission estimates comparison for N<sub>2</sub>O for the UK. The annual InTEM estimates (2012-2021) are, on average,  $5.4 \pm 0.9$  Tg CO<sub>2</sub>-eq yr<sup>-1</sup> higher than those reported by the GHGI. Neither the InTEM estimates (2012-2021) or the GHGI (2012-2021) are showing a statistically significant trend in UK N<sub>2</sub>O emissions. The GHGI estimates show a sharp decline (~9 Tg CO<sub>2</sub>-eq) between 1998 and 1999 in line with the introduction of clean technology at an adipic acid plant in Wilton, northeast England. It is estimated that they cut their emissions of N<sub>2</sub>O by 90%, from 12 Tg CO<sub>2</sub>-eq yr<sup>-1</sup> to around 1.6 Tg CO<sub>2</sub>-eq yr<sup>-1</sup>. The improved network of observations from 2012 onwards allows a very strong seasonal cycle (average peak to trough amplitude is 1.4 Tg CO<sub>2</sub>-eq mth<sup>-1</sup>) in UK emissions to be observed. **Figure A 6.6** shows there is a peak in UK emissions in spring-summer (on average 2.7 Tg CO<sub>2</sub>-eq mth<sup>-1</sup>) and a minimum in the winter months (on average 1.3 Tg CO<sub>2</sub>-eq mth<sup>-1</sup>), aligned with the traditional fertiliser application period. There is however a strong year-to-year variability in this seasonal pattern demonstrating the impact of varying meteorology on the emissions of N<sub>2</sub>O. The spatial pattern of emissions in each season is shown in **Figure A 6.7** revealing a more widely distributed emission pattern than for CH<sub>4</sub>.

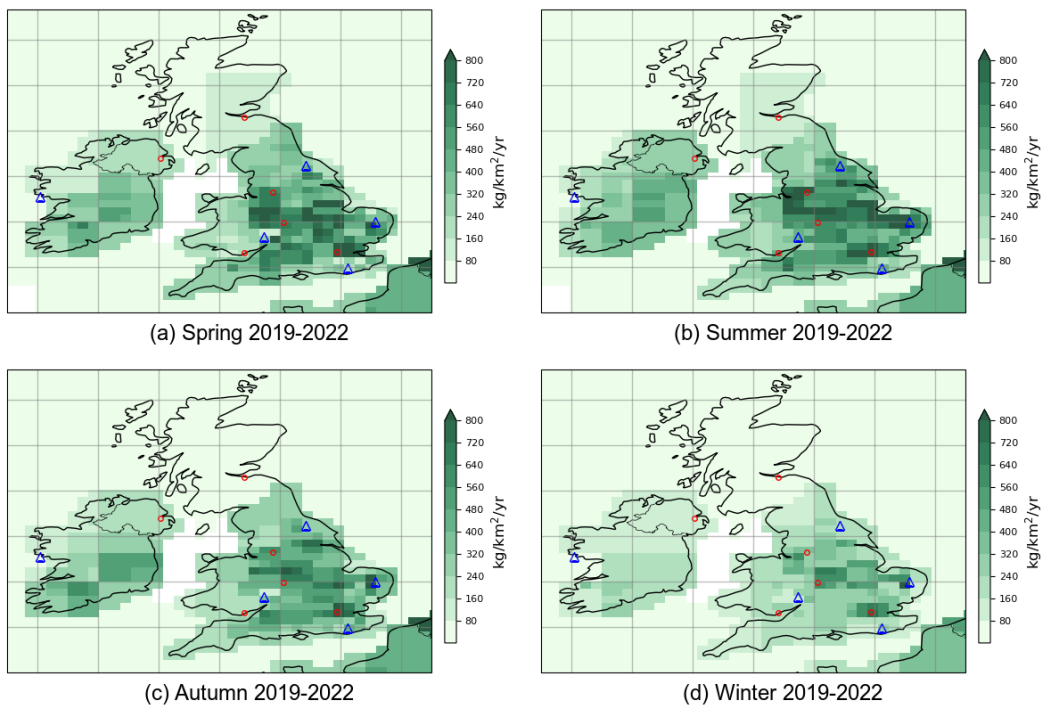
The nature of the N<sub>2</sub>O emissions (related to fertiliser application and subsequent rainfall and runoff) challenges the InTEM assumption of uniformity of release both in time (within the monthly InTEM timeframe) and space (within the InTEM grid resolution). Also, the point of release to the atmosphere may not be coincidental with the activity ultimately responsible for generating the N<sub>2</sub>O e.g. the N<sub>2</sub>O, or its precursors, may be transported from its source, for example by rivers, prior to its release to the atmosphere.



**Figure A 6.6** Verification of the UK emission inventory estimates for N<sub>2</sub>O in Tg CO<sub>2</sub>-eq month<sup>-1</sup> from 2012. GHGI estimates are shown in black. InTEM 1-month estimates are shown in blue ( $\pm 1\sigma$ ).



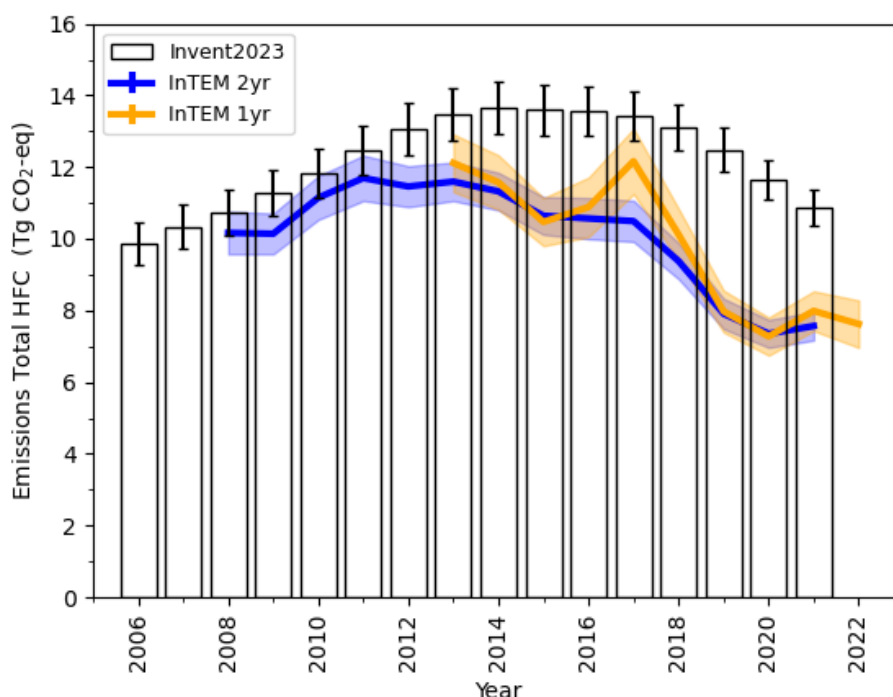
**Figure A 6.7** Four-year average N<sub>2</sub>O InTEM emission estimates (kg km<sup>-2</sup> yr<sup>-1</sup> of gas) 2019-2022 by season: (a) Spring (b) Summer (c) Autumn and (d) Winter. The observation stations are shown as blue triangles. Major cities are shown as red circles.



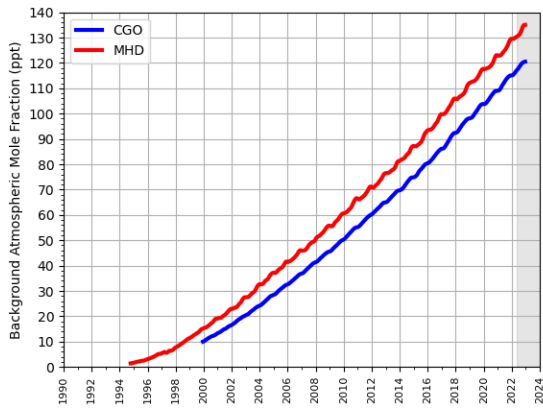
## A 6.4 HYDROFLUOROCARBONS

**Figure A 6.8** shows the sum of the reported and inferred UK HFC emissions (HFC-125, HFC-134a, HFC-143a, HFC-152a, HFC-23, HFC-32, HFC-227ea, HFC-245fa, HFC-365mfc and HFC-43-10mee) in Tg CO<sub>2</sub>-eq yr<sup>-1</sup>, combined using the AR5 GWP values. The GHGI is shown in black and InTEM annualised 2-year in blue and the 1-year in orange. The total InTEM HFC is consistently lower than the GHGI, with the best agreement between 2008-2011. Looking at the 2-year data, from 2013 the InTEM estimate starts to decrease, dropping more sharply from 2017 to 2020 before levelling off in 2021. The 1-year data is broadly consistent but has a peak in emissions in 2017 which is not seen in the more averaged 2-year results. The 1-year estimates for 2020, 2021 and 2022 suggest that the previously decreasing trend has ceased and total HFC emissions have remained static for the last three years. Note, the GHGI reports uncertainty for the HFCs collectively, they are not available for the individual gases.

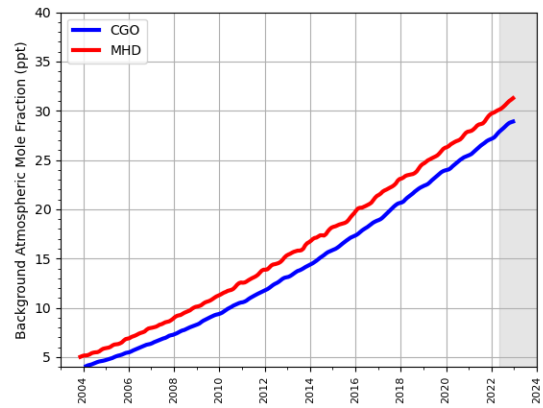
**Figure A 6.8** Sum of UK HFC emission estimates (HFC-125, HFC-134a, HFC-143a, HFC-152a, HFC-23, HFC-32, HFC-227ea, HFC-245fa, HFC-365mfc and HFC-43-10mee) in Tg CO<sub>2</sub>-eq yr<sup>-1</sup> from the GHGI (black) and InTEM, annualised 2-year inversion (blue) and 1-year inversion (orange). Note HFC-43-10mee (< 0.2 Tg CO<sub>2</sub>-eq yr<sup>-1</sup>) is included from 2011 when the observations start. The uncertainty bars represent ±1σ.



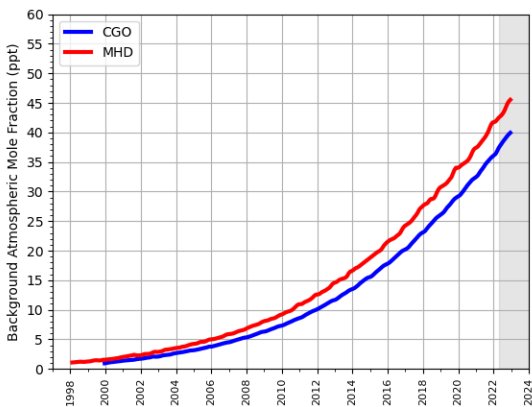
**Figure A 6.9** Background Northern Hemisphere monthly concentrations of six HFCs estimated from MHD, Ireland observations are shown in red, and background Southern Hemisphere monthly concentrations from CGO, Tasmania are shown in blue. Grey shading represents unratified data.



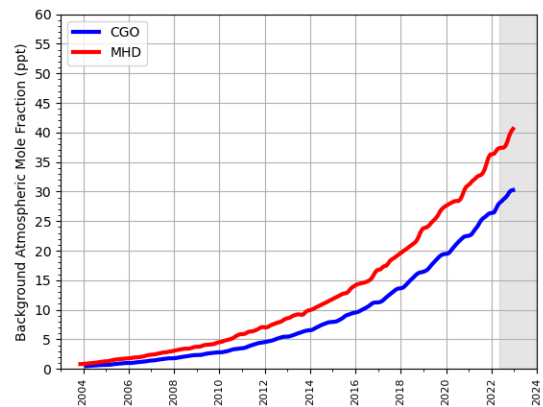
(a) HFC-134a



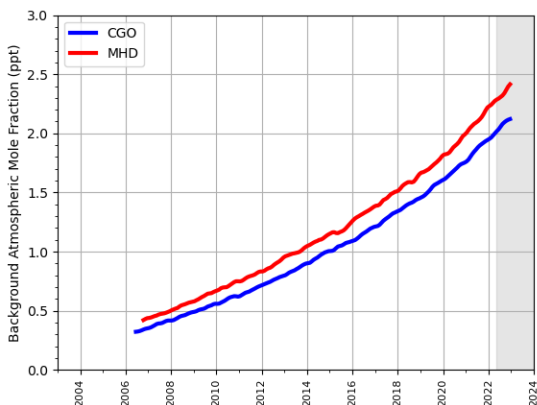
(b) HFC-143a



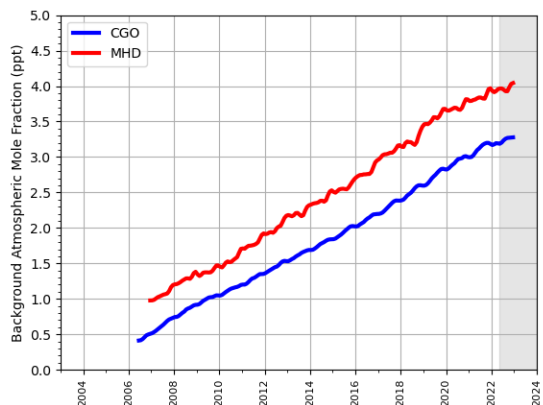
(c) HFC-125



(d) HFC-32

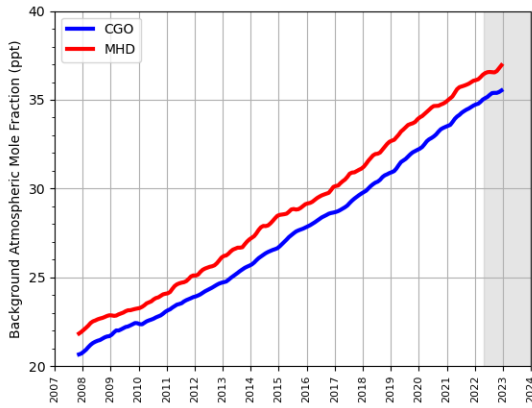


(e) HFC-227ea

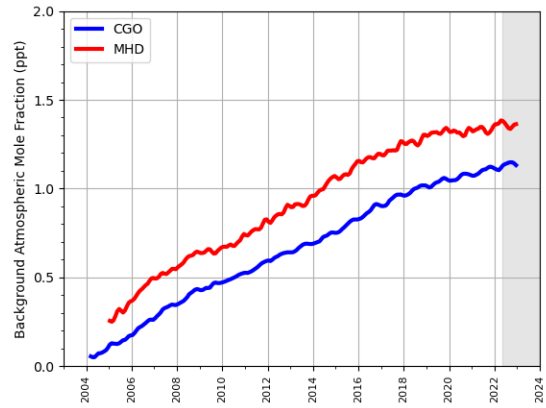


(f) HFC-245fa

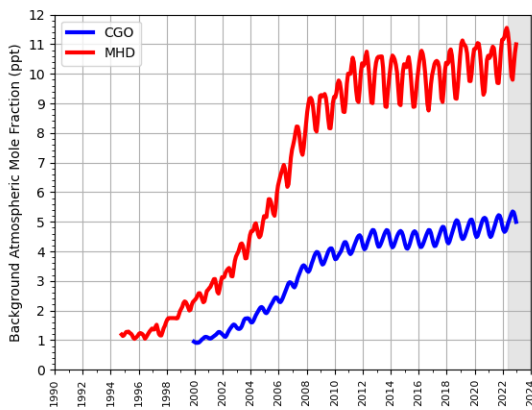
**Figure A 6.10** Background Northern Hemisphere monthly concentrations of four HFCs estimated from MHD, Ireland observations are shown in red, and background Southern Hemisphere monthly concentrations from CGO, Tasmania are shown in blue. Grey shading represents unratified data.



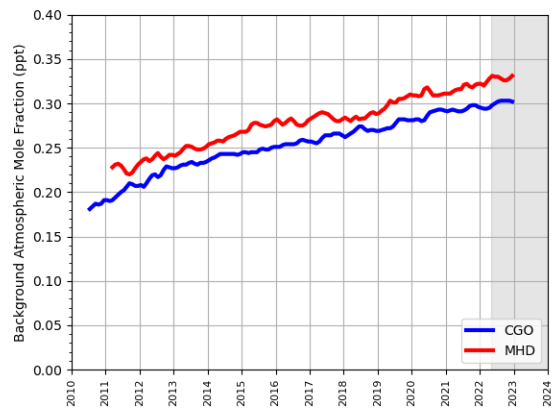
(a) HFC-23



(b) HFC-365mfc

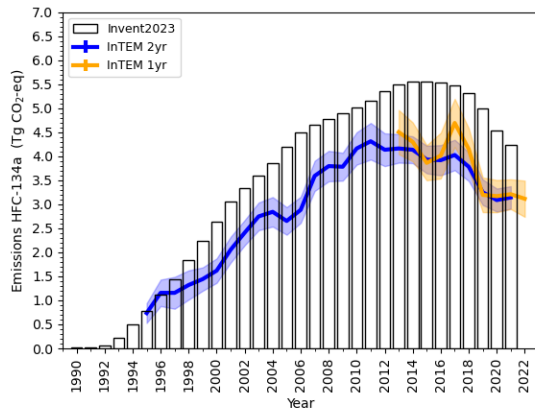


(c) HFC-152a

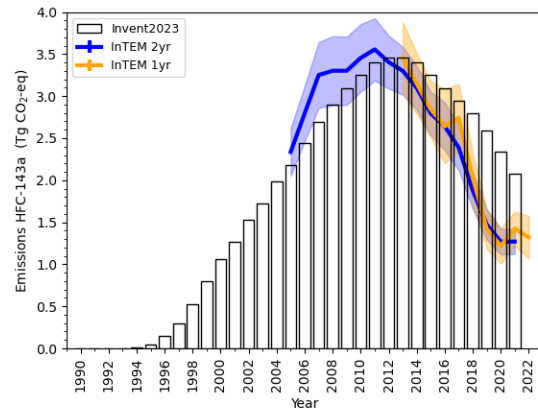


(d) HFC-43-10-mee

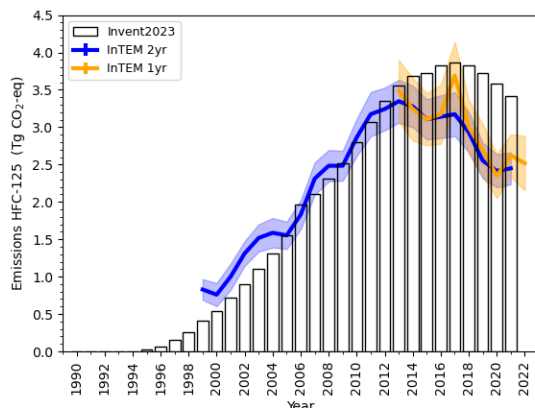
**Figure A 6.11 Comparison of the UK emission inventory estimates for individual HFCs in Tg CO<sub>2</sub>-eq yr<sup>-1</sup> from 1990. GHGI estimates are shown in black. InTEM 2-year estimates are shown in blue (±1σ), InTEM 1-year estimates are shown in orange (±1σ).**



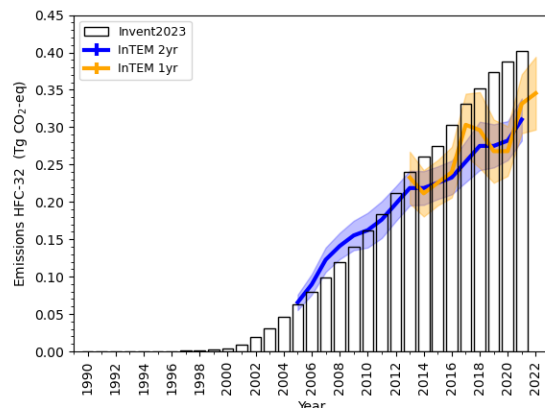
(a) HFC-134a



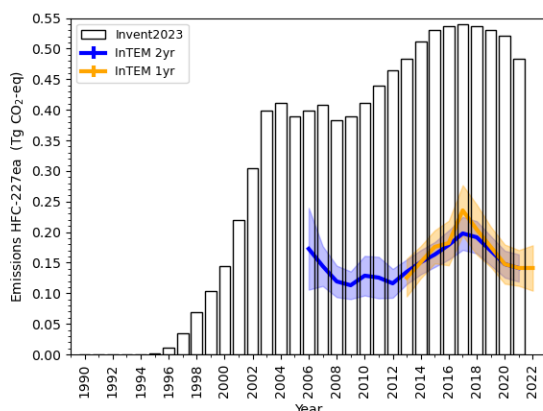
(b) HFC-143a



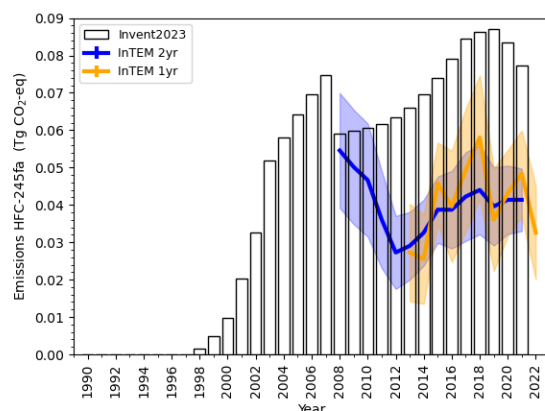
(c) HFC-125



(d) HFC-32

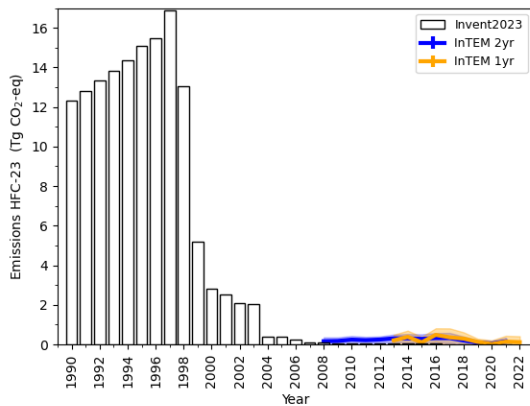


(e) HFC-227ea

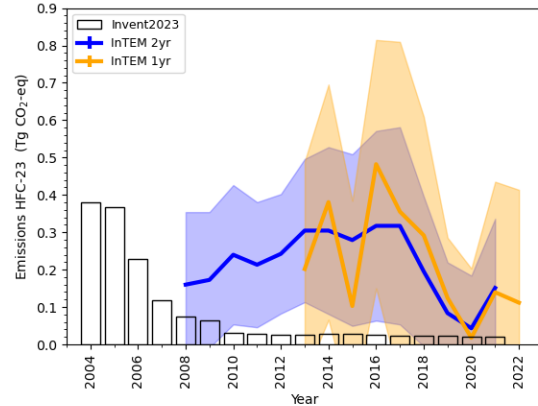


(f) HFC-245fa

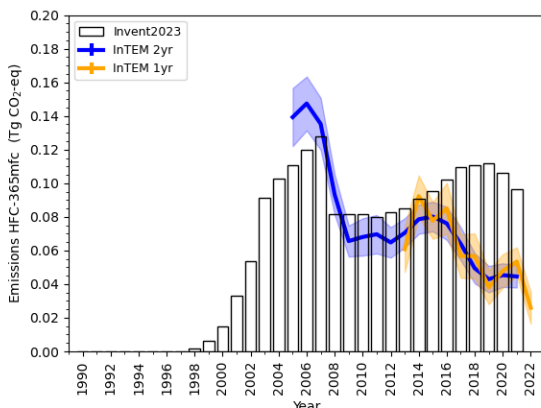
**Figure A 6.12** Verification of the UK emission inventory estimates for individual HFC's in Tg CO<sub>2</sub>-eq yr<sup>-1</sup> from 1990. GHGI estimates are shown in black. InTEM 2-year estimates are shown in blue ( $\pm 1\sigma$ ), InTEM 1-year estimates are shown in orange ( $\pm 1\sigma$ ).



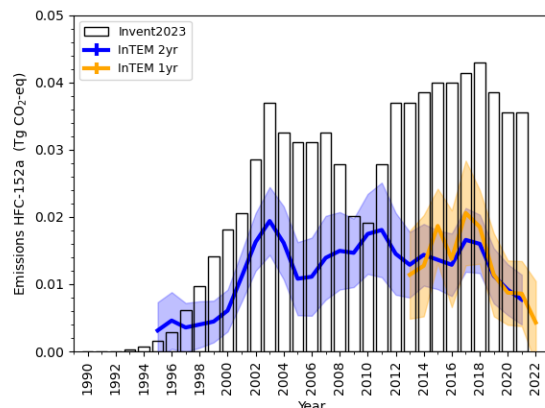
(a) HFC-23



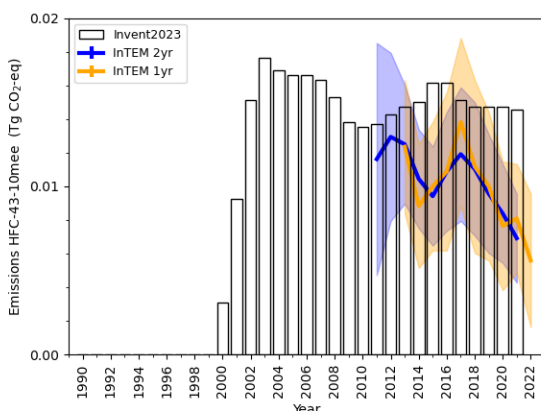
(b) HFC-23



(c) HFC-365mfc

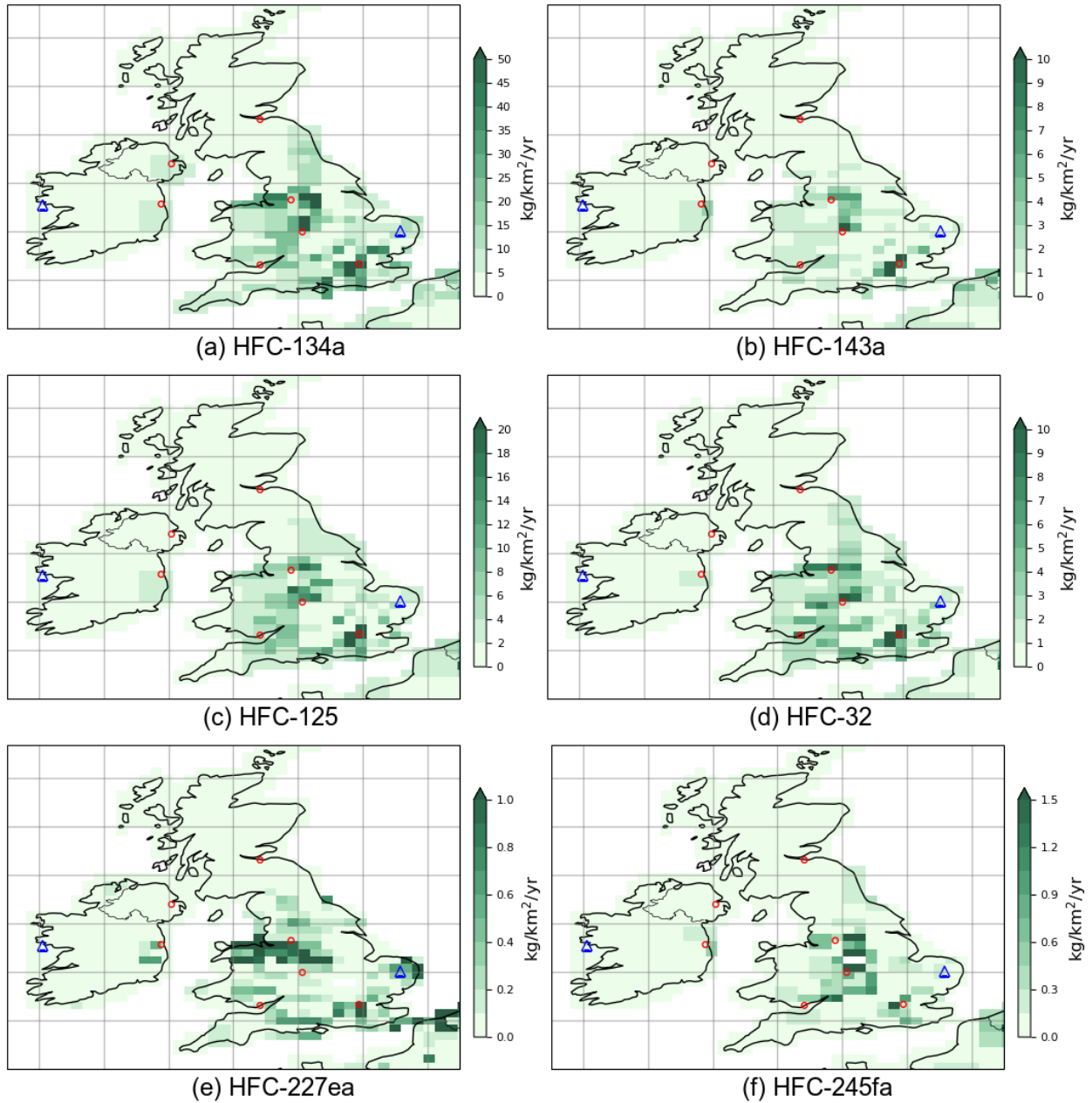


(d) HFC-152a

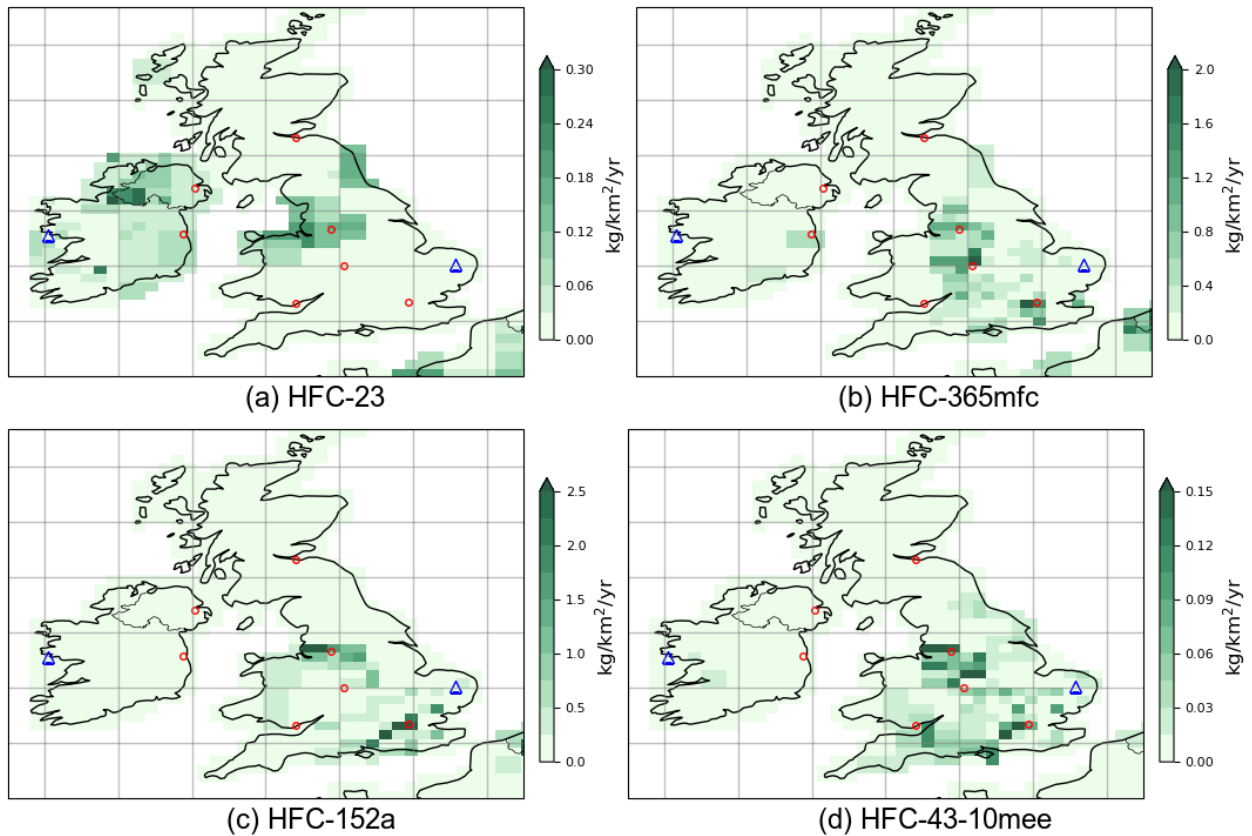


(e) HFC-43-10mee

**Figure A 6.13** Four-year average HFC-134a InTEM emission estimates ( $\text{kg km}^{-2} \text{yr}^{-1}$ ) 2019-2022. The observation stations are shown as blue triangles. Major cities are shown as red circles.



**Figure A 6.14** Four-year average HFC InTEM emission estimates ( $\text{kg km}^{-2} \text{yr}^{-1}$ ) 2019-2022. The observation stations are shown as blue triangles. Major cities are shown as red circles.



### A 6.4.1 HFC-134a

**Figure A 6.9** (a) shows the Hemisphere background atmospheric concentration of HFC-134a from 1995 onwards. The background trend is monotonic and positive, in 2022 the Northern Hemisphere background increased by 6.2 ppt.

**Figure A 6.11** (a) shows the InTEM and GHGI emission estimates for the UK for HFC-134a for the period 1990 onwards. The GHGI shows a stronger increase in emission compared to the InTEM estimates. The InTEM estimates have risen at about 70% of the rate of the GHGI. Between 1995 and 2011 the trend of the GHGI and InTEM is in agreement but the InTEM estimates are consistently lower than the GHGI estimates, with the difference well outside the InTEM uncertainty range, except for 1995 to 1997. From 2011, the InTEM 2-year estimate diverges from the GHGI and starts to gradually decline until 2018, whereas the GHGI rises until 2015 after which it starts to slowly decline. From 2018 both the GHGI and InTEM decline more quickly, with InTEM still estimating approximately 70% of the GHGI value. From 2020, the 2-year InTEM estimate levels off and plateaus in 2021. The 1-year InTEM results show much greater year-to-year variation and have an unexplained peak in 2017. The results for 2019-2021 are closely aligned with the 2-year results and the 2022 value indicates that the previous steady decrease in emissions may have ended. Since the implementation of phase three of the EU MAC directive (2006), on 1st January 2017, the use of fluorinated greenhouse gases with  $\text{GWPs}_{100}$  higher than 150 (mainly HFC-134a)



in all new models of cars and light vans sold in the EU has been banned. The impact of this policy is seen both in InTEM and the GHGI.

**Figure A 6.13 (a)** shows the average spatial InTEM emissions estimate for HFC-134a over the UK in  $\text{kg km}^{-2} \text{yr}^{-1}$ , for the four-year period 2019-2022. The variable grid resolution of InTEM produces a patchwork of different resolutions dependant on source signal at the measurement site. For HFC-134a, the highest emissions are generally focused on the more populated areas, with the highest emission region appearing over London and in the south of the UK with significant emissions also indicated in the populated regions around Birmingham, Leeds and Manchester.

### **A 6.4.2 HFC-143a**

**Figure A 6.9 (b)** shows the hemispheric background atmospheric concentrations of HFC-143a from 2004 onwards. The hemispheric background trend is positive, in 2022 the Northern Hemisphere background increased by 1.8 ppt.

InTEM emission estimates for the UK for HFC-143a for the period 2004 onwards are shown in **Figure A 6.11 (b)** and are compared to the GHGI estimates. UK emissions, as estimated by the GHGI, increased year-on-year from the early 1990s until a peak in 2012-2013, and thereafter estimated a gradual decline. The InTEM estimates show reasonable agreement with the GHGI, though is slightly higher between 2005 and 2011. Between 2012-2013 there is excellent agreement, and then InTEM follows the slope of the declining GHGI closely but is slightly lower from 2013-2017. After 2017, the InTEM estimates decline much more rapidly than the GHGI and is approximately 60% of the GHGI by 2019. The decline in InTEM estimates between 2019 and 2020 is very similar to the decline in the GHGI, maintaining the InTEM estimate as approximately 60% of the GHGI in 2020. InTEM emission estimates plateau from 2020 to 2022, indicating a levelling off of the previously sharply declining emissions of HFC-143a.

**Figure A 6.13 (b)** shows the average spatial InTEM emissions estimate for HFC-143a over the UK in  $\text{kg km}^{-2} \text{yr}^{-1}$ , for the four-year period 2019-2022. The highest emissions are generally focused around populated regions, with the highest emission area estimated to be over London and in the highly populated regions around Birmingham and further north to Manchester, in a similar distribution to that seen for HFC-134a.

### **A 6.4.3 HFC-125**

**Figure A 6.9 (c)** shows the hemispheric background atmospheric concentrations of HFC-125 from 1998 onwards. The background trend is monotonic and exponentially increasing, in 2022 the Northern Hemisphere background increased by 4.1 ppt.

InTEM emission estimates for the UK for HFC-125 for the period 1999 onwards are shown in **Figure A 6.11 (c)**. Both the InTEM and UK GHGI estimates suggest that the emissions of HFC-125 from the UK increased significantly from the 1990s. The InTEM estimates are slightly higher than the GHGI between 1999-2004, but between 2005-2013 there is excellent agreement. From 2014-2017, the 2-year InTEM estimates start to decline in contrast to the GHGI which continues to rise. The 1-year model largely follows the 2-year data with the exception of a much higher estimate in 2017. The GHGI starts to decrease from 2017, but not as rapidly as InTEM. By 2020 the InTEM estimate is approximately 70% of the GHGI. The InTEM estimates level off from 2020, with both 2021 and 2022 values being higher than the 2020 value.

**Figure A 6.13 (c)** shows the average spatial InTEM emissions estimate for HFC-125 over the UK in  $\text{kg km}^{-2} \text{yr}^{-1}$ , for the four-year period 2019-2022. Similar to HFC-134a and HFC-143a, the highest emissions are generally found in the more populated areas, with the highest emission region estimated to be over the London area.

#### **A 6.4.4 HFC-32**

**Figure A 6.9 (d)** shows the hemispheric background atmospheric concentration of HFC-32 from 2004 onwards. The background trend is monotonic and positive, in 2022 the Northern Hemispheric background increased by 4.7 ppt.

InTEM emission estimates for the UK for HFC-32 from 2005 onwards are shown in **Figure A 6.11 (d)**. The InTEM 2-year emission estimates match the GHGI estimates extremely well up until 2013. Between 2014-2021 the agreement is less good with the InTEM estimates not rising as rapidly as the GHGI. The InTEM 2-year estimates continue to increase throughout the period. The InTEM 1-year estimate shows more year-to-year variability and has a peak in 2017. The overall trend in the 1-year data is an increasing one, but at a slower rate than the GHGI.

**Figure A 6.13 (d)** shows the average spatial InTEM emissions estimate for HFC-32 over the UK in  $\text{kg km}^{-2} \text{yr}^{-1}$ , for the four-year period 2019-2022. As with the previous HFCs, the highest emissions are generally found in the more populated areas, with the highest emission region estimated to be over London.

#### **A 6.4.5 HFC-227ea**

**Figure A 6.9 (e)** shows the hemispheric background atmospheric concentrations of HFC-227ea from 2007 onwards. There is a positive trend in the background; in 2022 the Northern Hemispheric baseline increased by 0.2 ppt.

The GHGI estimates (**Figure A 6.11 (e)**) are significantly (~3 times) higher than those estimated by InTEM. The trend in emission estimates is similar between the GHGI and InTEM, although the InTEM estimates decline more rapidly than the GHGI. The InTEM 2021 and 2022 estimates shows a levelling off in the decline in emissions. The estimate for 2021 is less than a third of the magnitude of the GHGI emission estimate for 2021.

**Figure A 6.13 (e)** shows the average spatial InTEM emissions estimate for HFC-227ea over the UK in  $\text{kg km}^{-2} \text{yr}^{-1}$ , for the four-year period 2019-2022. The geographic distribution appears to largely follow population with the notable exception of the area around TAC and in North Wales or North West England. This is thought to be due to local emissions, probably from fire suppression maintenance and manufacture, and is worthy of further investigation.

#### **A 6.4.6 HFC-245fa**

**Figure A 6.9 (f)** shows the hemispheric background atmospheric concentrations of HFC-245fa from 2007 onwards. There is a positive trend in the background; in 2022 the Northern Hemispheric background increased by 0.1 ppt.

UK emissions of HFC-245fa are small in both the GHGI and InTEM. The InTEM estimates (**Figure A 6.11 (f)**) have significant uncertainty and are consistently lower than the GHGI estimates, with the exception of 2008 when there is reasonable agreement. The GHGI estimates show a significant decline between 2007 to 2008 and then a steady annual increase up to and including 2019, before a decrease in 2020 and 2021. The 2-year InTEM estimates show a sharp decrease

from 2008 to 2012, after which emissions increase steadily until 2018, after which they remain approximately level. The 1-year InTEM estimates follow the same trend as the 2-year, as would be expected, however there is high year-to-year variability in the estimated emissions of this gas making it hard to conclude whether the downturn in 2022 is significant or not.

**Figure A 6.13** (f) shows the average spatial InTEM emissions estimate for HFC-245fa over the UK in  $\text{kg km}^{-2} \text{yr}^{-1}$ , for the four-year period 2019-2022. HFC-245fa emissions follow the distribution of population over the UK.

### **A 6.4.7 HFC-23**

**Figure A 6.10** (a) shows the hemispheric background atmospheric concentrations of HFC-23 from 2008 onwards. The background trend is monotonic and positive, in 2022 the Northern Hemispheric background increased by 0.9 ppt.

**Figure A 6.12** (a) and (b) show the GHGI and InTEM emission estimates for the UK for HFC-23 from (a) 1990 and (b) 2004 using a different scale. The InTEM estimates from 2009 onwards are higher than the emissions estimated by the GHGI until 2020 when they agree, before rising again in 2021 and 2022. It should be noted however that the InTEM uncertainties are large and often extend down to zero. From the observations it is clear that some intermittent emissions of HFC-23 occur in the UK.

**Figure A 6.14** (a) shows the average spatial InTEM emissions estimate for HFC-23 over the UK in  $\text{kg km}^{-2} \text{yr}^{-1}$ , for the four-year period 2019-2022. The levels of HFC-23 are fairly uniform over the UK, with areas of higher emissions indicated near Hull on the east coast of England, around Liverpool and North Wales and in Northern Ireland.

### **A 6.4.8 HFC-365mfc**

**Figure A 6.10** (b) shows the hemispheric background atmospheric concentration of HFC-365mfc from 2004 onwards. There was a positive trend in the Hemispheric backgrounds up until 2019 but no growth was estimated in the Northern Hemisphere in 2022.

The GHGI (**Figure A 6.12** (c)) shows a sharp decline in emissions from 2007 to 2008 and the InTEM 2-year estimates show a similar response. The InTEM 2-year estimates are larger than the GHGI from 2005 to 2007, and then lower from 2009 onwards, but matches the rise in emissions from 2012 to 2015 before declining sharply. The 1-year InTEM estimates follow the same trend but have higher values in 2014 and 2016. The InTEM 2-year estimates level off from 2019 to 2021 and are under half the magnitude of the GHGI. The 1-year emission estimate for 2022 shows a further decrease.

**Figure A 6.14** (b) shows the average spatial InTEM emissions estimate for HFC-365mfc over the UK in  $\text{kg km}^{-2}\text{yr}^{-1}$ , for the four-year period 2019-2022. The levels of HFC-365mfc emission are relatively uniform over England and Wales, areas of higher population do show slightly enhanced emissions. Higher emissions are indicated on the near continent in Belgium.

### **A 6.4.9 HFC-152a**

**Figure A 6.10** (c) shows the background atmospheric concentration of HFC-152a from 1995 onwards. The Northern Hemispheric background concentration shows a strong rise from the mid-1990s until 2008, then a much-reduced annual increase until 2012. Between 2012-2017 a small decline is observed (Simmonds et al., 2016), followed by a rise, peaking in 2019. The Northern

and Southern Hemispheric differences are exacerbated for this gas because of its relatively short atmospheric lifetime (1.6 years). In 2022 the Northern Hemispheric background increased by 0.3 ppt.

**Figure A 6.12** (d) shows the InTEM and the GHGI emission estimates for the UK for HFC-152a for the period 1990 onwards. Between 1999-2008 and from 2012 onwards, the GHGI estimates are significantly larger than those estimated from InTEM. It is also interesting to note that the increasing trend from 2010 to 2018 in the UK GHGI is in contrast with a much flatter InTEM trend followed by a sharp decline from 2017 to 2022. The InTEM estimate is < 20% of the GHGI in 2021.

**Figure A 6.14** (c) shows the average spatial InTEM emissions estimate for HFC-152a over the UK in  $\text{kg km}^{-2} \text{yr}^{-1}$ , for the four-year period 2019-2022. Similar to HFC-134a, the highest emissions are generally located in the more populated areas, with the highest emission region estimated to be over the London area.

### **A 6.4.10 HFC-43-10mee**

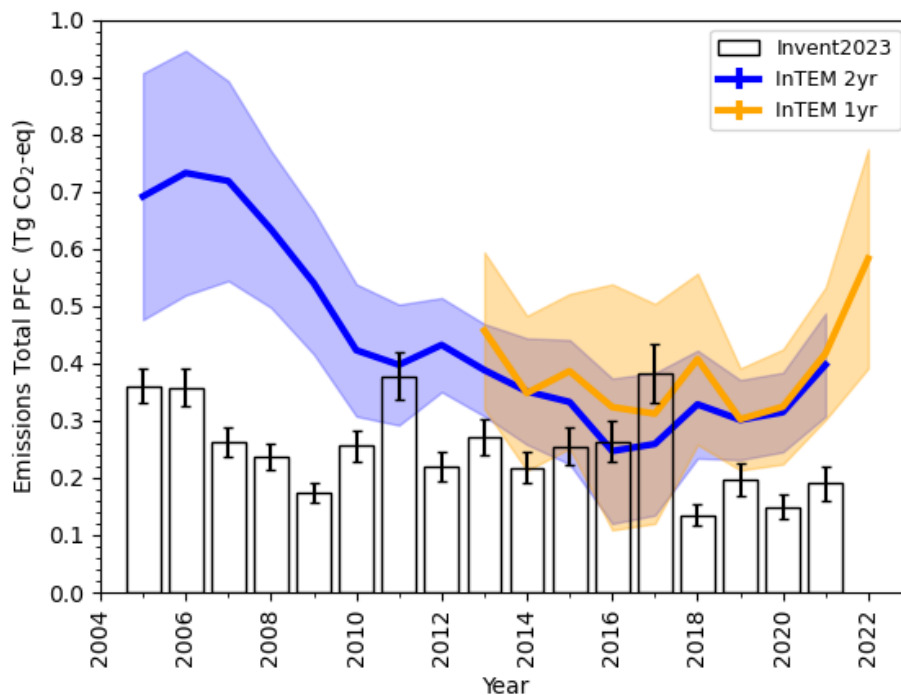
**Figure A 6.10** (d) shows the hemispheric background atmospheric concentration of HFC-43-10mee from 2011 onwards. There is a positive trend in the background, in 2022 the Northern Hemispheric baseline concentration increased by 0.01 ppt.

As estimated by both methods, the UK emissions of this gas are small (**Figure A 6.12** (e)). The GHGI estimates are initially in agreement with those estimated by InTEM, but the GHGI then has a small rise to 2015 and 2016, just as the InTEM emissions drop sharply to a low point in 2014 and 2015, before rising back up until 2017, before dropping monotonically. Throughout the InTEM uncertainty estimate is large relative to the emission. The spatial distribution is shown in **Figure A 6.14** (d) and is largely similar to the other HFCs, i.e. spread by population.

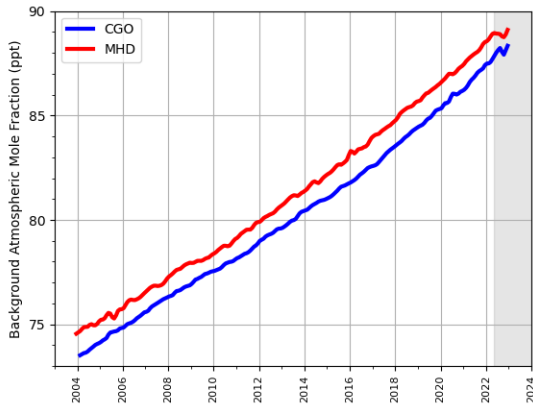
## **A 6.5 PERFLUOROCARBONS**

Figure A 6.15 shows the sum, by  $\text{GWP}_{100}$ , of UK emissions of PFCs, (PFC-14, PFC-116, PFC-218, PFC-318) in  $\text{Tg CO}_2\text{-eq yr}^{-1}$ . The GHGI is shown in black and InTEM annualised 2-year in blue and the 1-year in orange. The InTEM PFC estimate is considerably higher than the GHGI until 2011 when the agreement starts to improve. From 2018 to 2021 the InTEM estimates are approximately a factor of two higher than the GHGI estimate. The 1-year InTEM result for 2021 and 2022 indicates a sharp rise in total PFC. Note, the GHGI reports uncertainty for the PFCs collectively, uncertainties are not available for the individual gases.

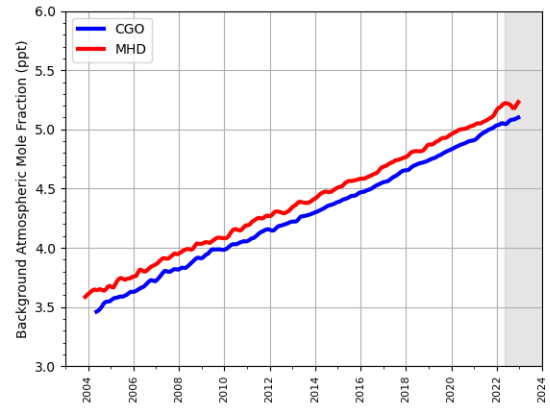
**Figure A 6.15** Sum of UK PFC emission estimates (PFC-14, PFC-116, PFC-218, PFC-318) in Tg CO<sub>2</sub>-eq yr<sup>-1</sup> from the GHGI (black) and InTEM, annualised 2-year inversion (blue) and 1-year inversion (orange). The InTEM uncertainty bounds represent 1-σ.



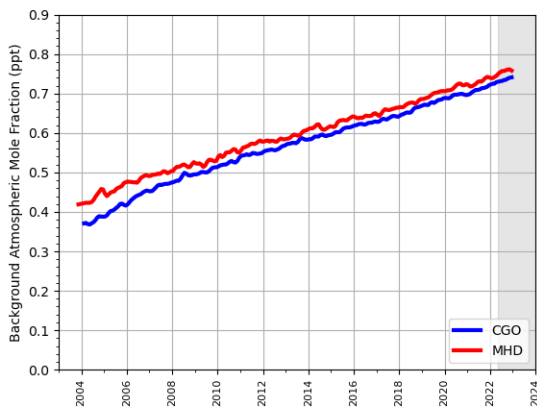
**Figure A 6.16** Background Northern Hemisphere monthly concentrations of four PFCs estimated from MHD, Ireland observations are shown in red, and background Southern Hemisphere monthly concentrations from CGO, Tasmania are shown in blue. Grey shading represents unratified data.



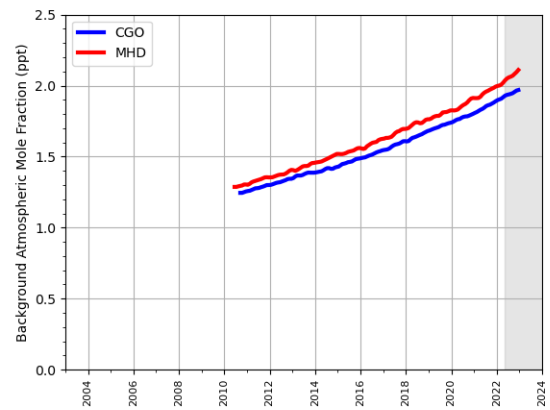
(a) PFC-14



(b) PFC-116

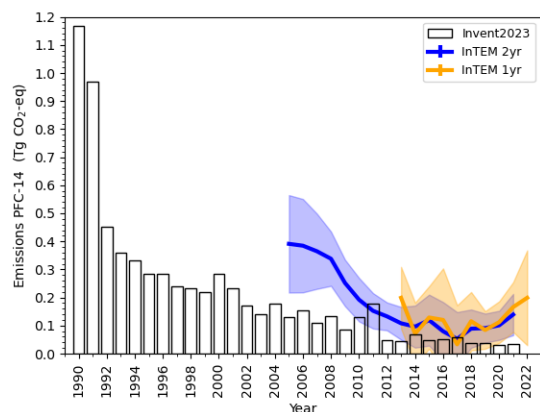


(c) PFC-218

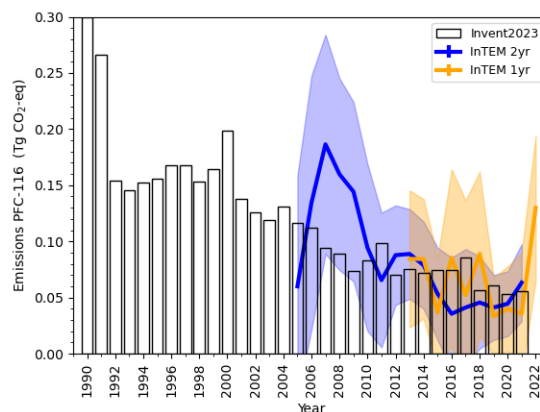


(d) PFC-318

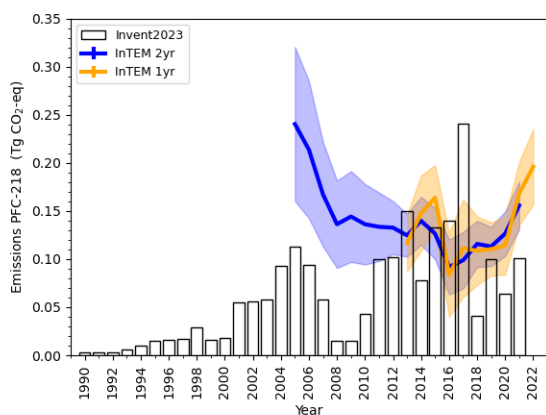
**Figure A 6.17** Verification of the UK emission inventory estimates for PFCs in Tg CO<sub>2</sub>-eq yr<sup>-1</sup> from 1990. GHGI estimates are shown in black. InTEM 2-year estimates are shown in blue ( $\pm 1 \sigma$ ), InTEM 1-year estimates are shown in orange ( $\pm 1 \sigma$ ).



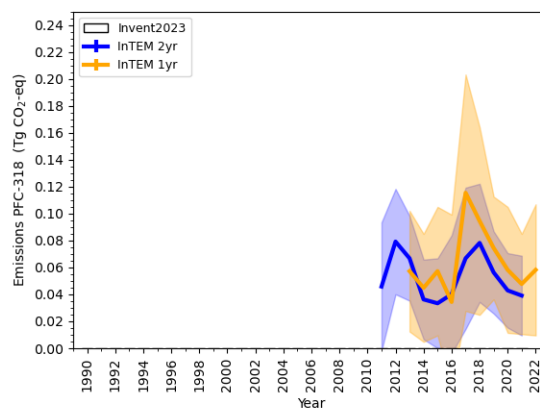
(a) PFC-14



(b) PFC-116

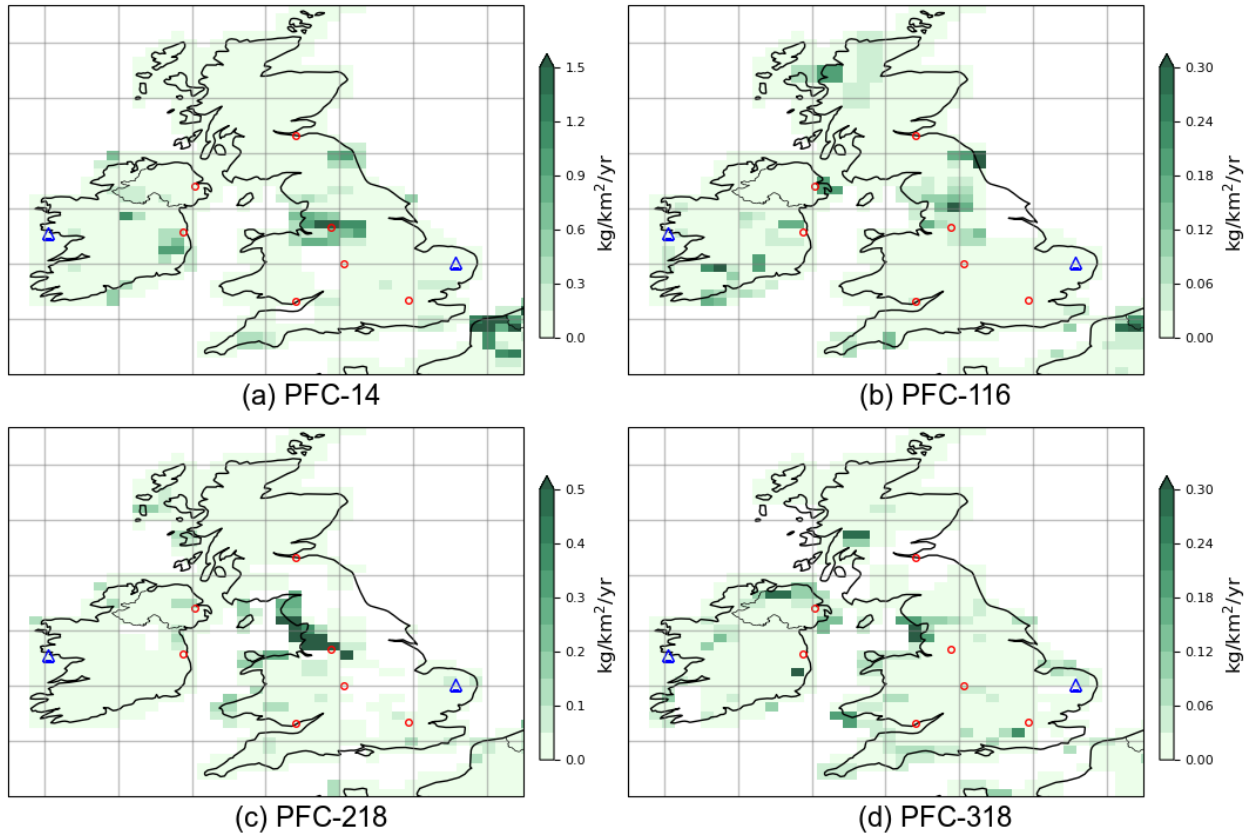


(c) PFC-218



(d) PFC-318

**Figure A 6.18** Four-year average PFC InTEM emission estimates ( $\text{kg km}^{-2} \text{yr}^{-1}$ ) 2019-2022. The observation stations are shown as blue triangles. Major cities are shown as red circles.



### A 6.5.1 PFC-14

**Figure A 6.16** (a) shows the hemispheric background atmospheric concentrations of PFC-14 from 2004 onwards. The background trend is positive, in 2022 the Northern Hemispheric background concentration increased by 0.9 ppt.

The drop in emissions in 2012 seen in the GHGI (**Figure A 6.17**(a)) reflects the closure of a large aluminium production plant in the UK. The InTEM uncertainty ranges are large and the estimates are approximately double the GHGI from 2005 to 2010. InTEM estimates then gradually fall more in line with the GHGI although the estimated uncertainties are still large and often extend down to zero, probably because the majority of emissions come from intermittently emitting point sources. Overall there is reasonable agreement between the GHGI and the InTEM estimates over the last ten years, however it does look as if the slight decreasing trend from 2018 in the GHGI is at odds with a slightly increasing trend emerging in the InTEM estimates.

**Figure A 6.18** (a) shows the average spatial InTEM emissions estimate for PFC-14 over the UK in  $\text{kg km}^{-2} \text{yr}^{-1}$ , for the four-year period 2019-2022. The spatial distribution of PFC-14 shows sources in the NW of England, south of Dublin and on the near-continent.



### A 6.5.2 PFC-116

**Figure A 6.16 (b)** shows the hemispheric background atmospheric concentrations of PFC-116 from 2004 onwards. The background trend is monotonic and positive and in 2022 the Northern Hemispheric background concentration increased by 0.1 ppt.

The UK InTEM estimates have large uncertainties that generally overlap with the GHGI estimates (**Figure A 6.17 (b)**) in the last ten years. The InTEM estimates show an upward trend for the last few years, though with high uncertainty. The 2019-2022 geographical spread of emissions (**Figure A 6.18 (b)**) shows the most significant sources are in the southern Republic of Ireland, around Belfast, Northern Ireland, and Northeast England. There are also sources on the near-continent.

### A 6.5.3 PFC-218

**Figure A 6.16 (c)** shows the hemispheric background atmospheric concentrations of PFC-218 from 2004 onwards. The background trend is monotonic and positive and in 2022 the Northern Hemispheric background concentration increased by 0.02 ppt.

The InTEM estimates are higher than those reported in the GHGI from 2005 to 2012 (**Figure A 6.17 (c)**), though the very clear fall in UK GHGI emissions between 2005 and 2008 is replicated by the InTEM estimates. There is better agreement from 2013, with the InTEM estimates remaining largely flat whilst the GHGI showing a strong year-to-year variation, most notably in 2017. The InTEM 1-year estimate shows a sharp increase from 2020 to 2022. The 2019-2022 geographical distribution of emissions (**Figure A 6.18 (c)**) shows that the most significant source is clearly in Northwest England, the home of the UK's only PFC-218 production facility.

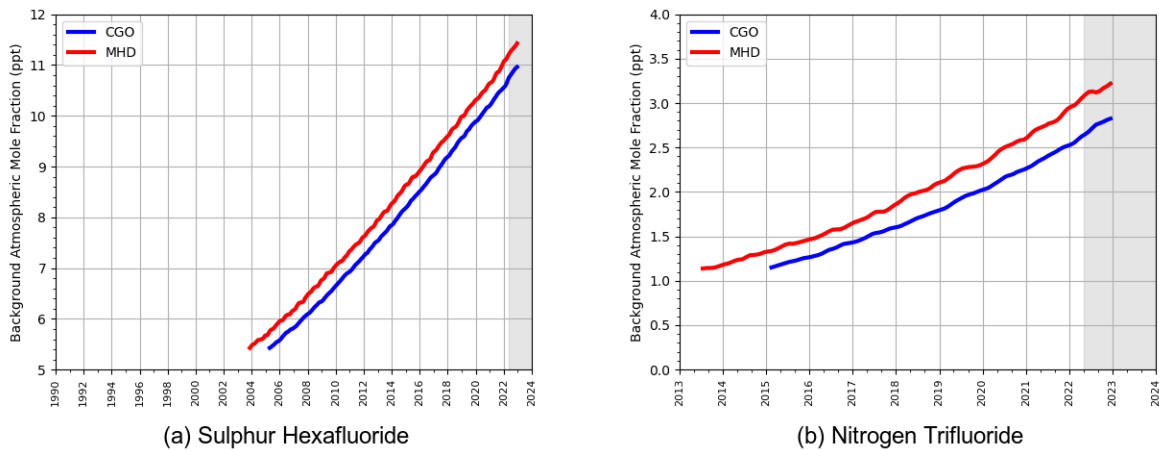
### A 6.5.4 PFC-318

**Figure A 6.16 (d)** shows the hemispheric background atmospheric concentrations of PFC-318 from 2011 onwards. The background trend is monotonic and positive and in 2022 the Northern Hemisphere background concentration increased by 0.1 ppt.

The UK InTEM estimates are between 0.03 and 0.12 Tg CO<sub>2</sub>-eq yr<sup>-1</sup> significantly higher than emissions reported in the GHGI at ~0.00007 Tg CO<sub>2</sub>-eq yr<sup>-1</sup> (**Figure A 6.17 (d)**). However, the InTEM estimated quantities have large uncertainties, sometimes extending down to zero emissions. The geographical spread of emissions is shown in **Figure A 6.18 (d)**, and sources can be seen in Northwest of England, in the west of Scotland, in Northern Ireland and in Ireland to the south of Dublin.

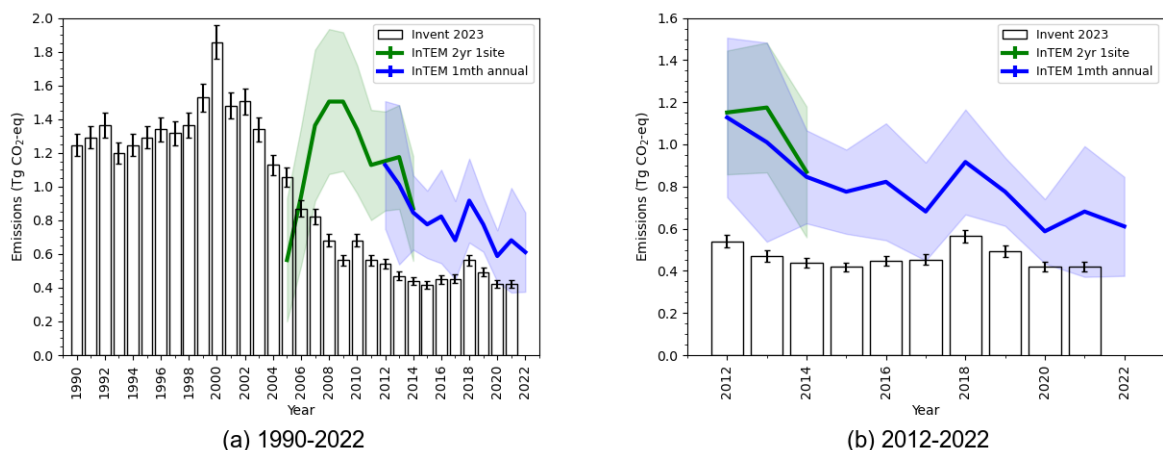
## A 6.6 SULPHUR HEXAFLUORIDE

**Figure A 6.19** Background Northern Hemisphere monthly concentrations of (a) SF<sub>6</sub> and (b) NF<sub>3</sub> estimated from MHD, Ireland observations are shown in red, and background Southern Hemisphere monthly concentrations from CGO, Tasmania are shown in blue. Grey shading represents unratified data.



**Figure A 6.19** (a) shows the hemispheric background atmospheric concentrations of sulphur hexafluoride (SF<sub>6</sub>) from 2004 onwards. The background trend is monotonic and positive and in 2022 the Northern Hemispheric background concentration increased by 0.4 ppt.

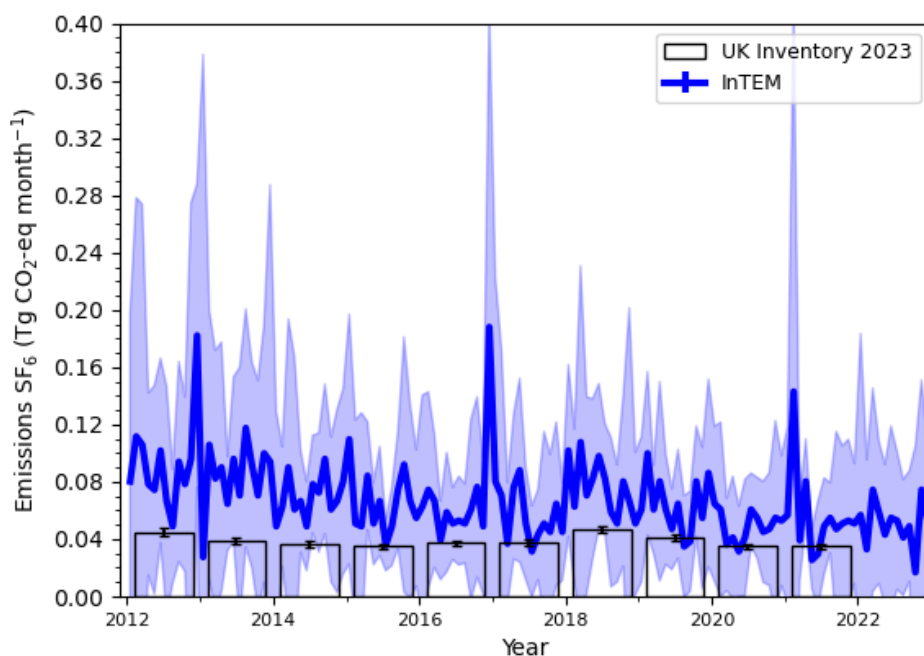
**Figure A 6.20** Verification of the UK emission inventory estimates for SF<sub>6</sub> in Tg CO<sub>2</sub>-eq yr<sup>-1</sup> from (a) 1990 and (b) 2012. GHGI estimates are shown in black. InTEM 2-year estimates are shown in green ( $\pm 1 \sigma$ ), InTEM annualised 1-month estimates are shown in blue ( $\pm 1 \sigma$ ).



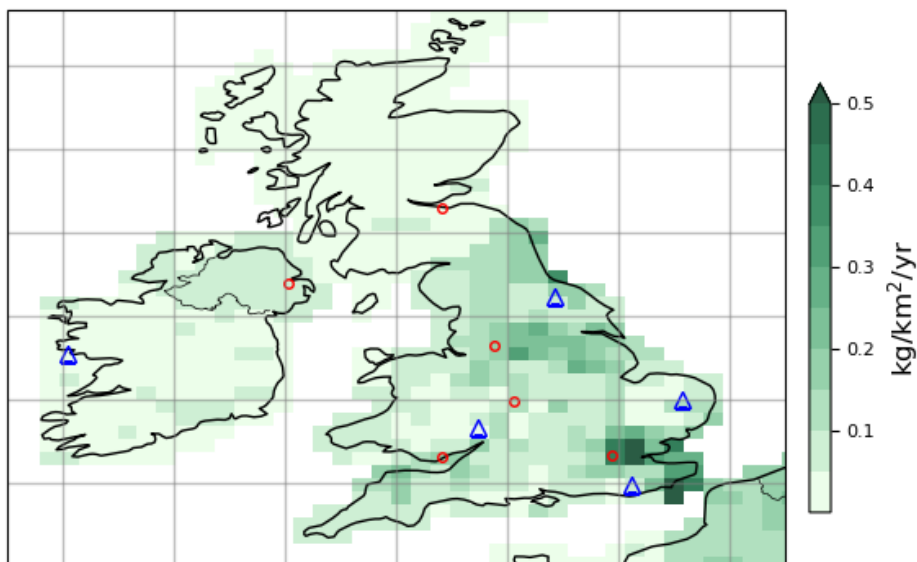
The UK 2-year InTEM estimates (**Figure A 6.20**) show a sharp rise from 2005 until 2008 and then a steep decline until 2016. From 2002 until 2009 the GHGI shows a steady decline from ~1.2 Tg CO<sub>2</sub>-eq yr<sup>-1</sup> to ~0.7 Tg CO<sub>2</sub>-eq yr<sup>-1</sup>, a rise in 2010 and then a slow decline up to 2015 and a rise

until 2018. Whilst there is poor agreement between the GHGI and InTEM from 2004-2015, from 2016 there is good agreement especially from 2018-2020 following the decreasing trend. Looking at the monthly emissions (**Figure A 6.21**) such elevations appear to be linked to specific events in individual months e.g. Dec 2016. There is no evidence of a strong seasonal cycle in UK SF<sub>6</sub> emissions, although there are specific months with very elevated estimated emissions. The observations themselves reveal some very large, short-lived, pollution events that are worthy of further investigation. The estimated spatial distribution of emissions 2019-2022 from InTEM is shown in **Figure A 6.22**. The emissions do not appear to be distributed by population or from a single emission source. The main reported sources of emissions in the UK are from use in high-voltage switchgear which is widespread across the UK.

**Figure A 6.21** Verification of the UK emission inventory estimates for SF<sub>6</sub> in Tg CO<sub>2</sub>-eq yr<sup>-1</sup> from 2012. GHGI estimates are shown in black. InTEM 1-month estimates are shown in blue ( $\pm 1 \sigma$ ).



**Figure A 6.22** Four-year average SF<sub>6</sub> InTEM emission estimates (kg km<sup>-2</sup> yr<sup>-1</sup> of gas) 2019-2022. The observation stations are shown as blue triangles. Major cities are shown as red circles.

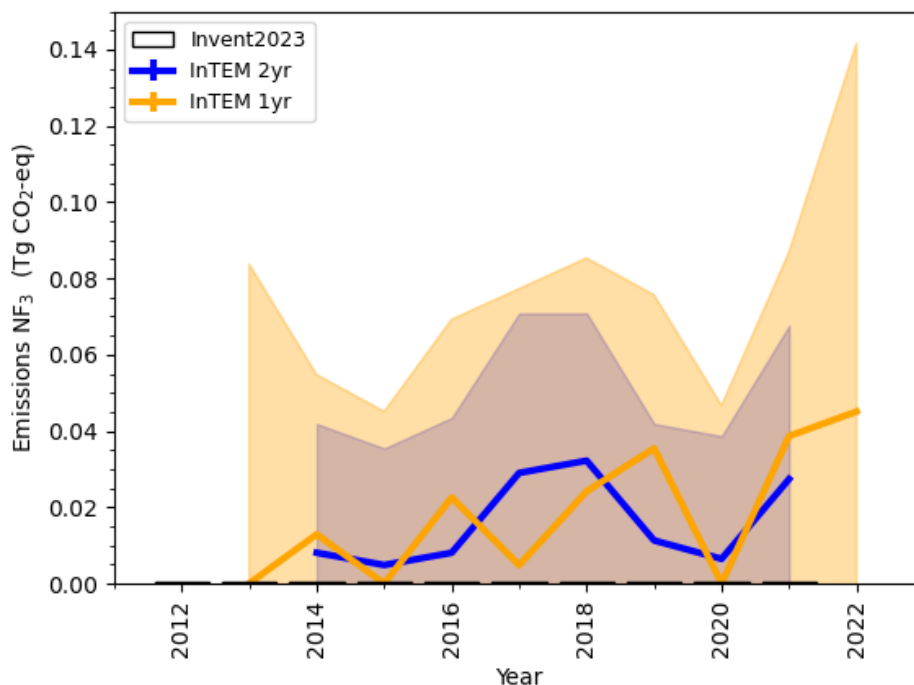


## A 6.7 NITROGEN TRIFLUORIDE

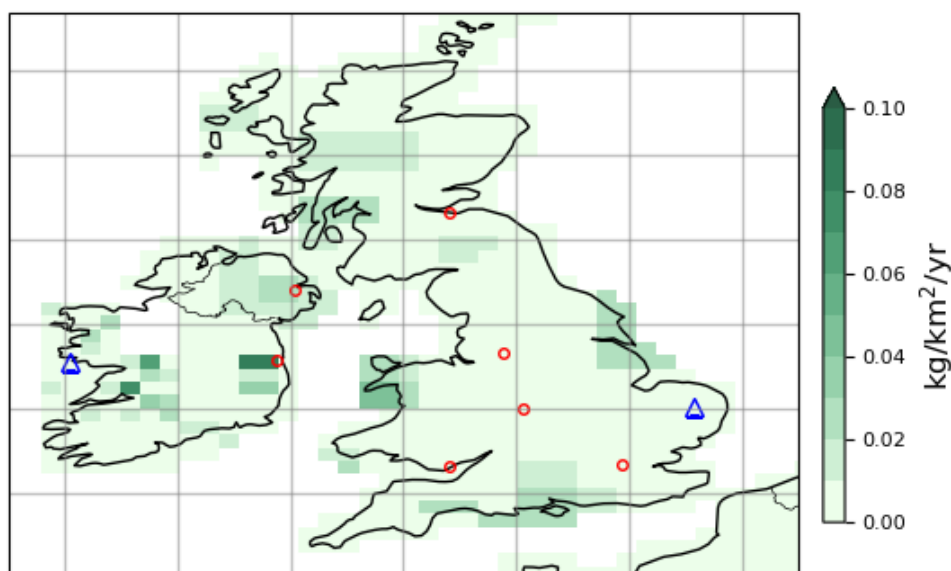
**Figure A 6.19** (b) shows the hemispheric background atmospheric concentrations of nitrogen trifluoride (NF<sub>3</sub>) from 2014 onwards. The background trend is monotonic and positive, and the Northern Hemispheric atmospheric concentration increased by 0.3 ppt in 2022.

NF<sub>3</sub> is only measured at MHD, JFJ and CBW (2021 & 2022 only). The InTEM emission estimates for the UK are ~0.005 - 0.02 Tg CO<sub>2</sub>-eq yr<sup>-1</sup> (**Figure A 6.23**) but with uncertainties that extend down to zero. The GHGI estimate for 2020 is 0.00036 Tg CO<sub>2</sub>-eq yr<sup>-1</sup>. **Figure A 6.24** shows the 4-year average InTEM emission map (2019-2022). NF<sub>3</sub> emissions are very low and the most significant source is seen around Dublin in Ireland. NF<sub>3</sub> has been introduced in the semiconductor industry as a more efficient fluorine source than PFC-116.

**Figure A 6.23** Verification of the UK emission inventory estimates for  $\text{NF}_3$  in  $\text{Tg CO}_2\text{-eq yr}^{-1}$  from 2012. GHGI estimates are too small to see. InTEM 2-year estimates are shown in blue ( $\pm 1 \sigma$ ), InTEM 1-year estimates are shown in orange ( $\pm 1 \sigma$ ).



**Figure A 6.24** Four-year average  $\text{NF}_3$  InTEM emission estimates ( $\text{kg km}^{-2} \text{yr}^{-1}$  of gas) 2019-2022. The observation stations are shown as blue triangles. Major cities are shown as red circles.



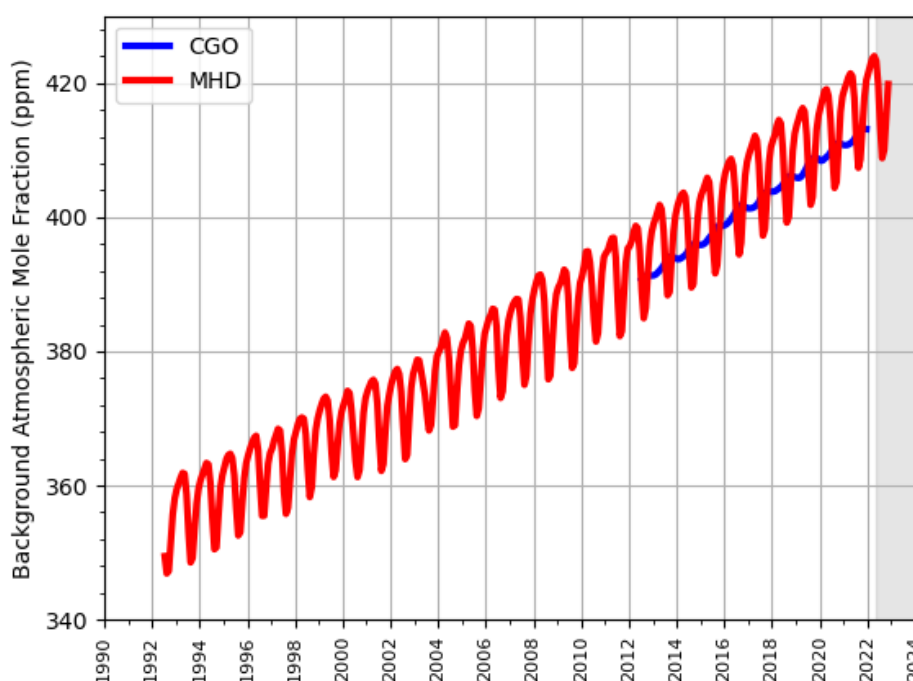
## A 6.8 CARBON DIOXIDE

High precision, high frequency measurements of carbon dioxide (CO<sub>2</sub>) are made across the UK DECC network. The Northern Hemisphere background trend is positive; in 2022 it increased by 2.5 ppm. The background has a strong seasonal cycle due to the influence of the biosphere with a maximum in early spring and a minimum in late summer.

The CO<sub>2</sub> observed has three principle components:

1. Northern hemisphere background (**Figure A 6.24**).
2. Anthropogenic (man-made)
3. Non-anthropogenic (natural)

**Figure A 6.25** Background Northern Hemisphere monthly concentrations of CO<sub>2</sub> estimated from MHD, Ireland observations (data obtained from LSCE equipment through a data sharing agreement) are shown in red, and background Southern Hemisphere monthly concentrations from CGO, Tasmania are shown in blue. Grey shading represents unratified data.



Since plants both produce CO<sub>2</sub> through respiration and absorb CO<sub>2</sub> through photosynthesis, the CO<sub>2</sub> flux from vegetation has a strong diurnal and seasonal cycle and switches from production to absorption on a daily basis. This unknown natural (biogenic) component of the observed CO<sub>2</sub> is significant when compared to the anthropogenic (man-made) component and cannot be ignored. It is difficult to use CO<sub>2</sub> measurements directly in an inversion to estimate anthropogenic emissions because (a) it is not possible to distinguish between biogenic and anthropogenic CO<sub>2</sub>, and (b) the diurnally varying biogenic CO<sub>2</sub> flux is at odds with a key assumption of the inversion method, namely that emissions do not strongly vary in time over the inversion time-window (say monthly). Methods are under development to attempt to over-come these challenges, such as: the use of isotopic observations, through ratios with respect to anthropogenic carbon monoxide

(CO), and tracking at what time of day air passes over the ground and using biogenic process models. The uncertainties associated with each of these methods are predicted to be significant.

The estimated uncertainties in the CO<sub>2</sub> GHGI are very small compared to inversion results. Work is on-going to seek to improve our methods of verifying inventory CO<sub>2</sub> emission estimates.

# ANNEX 7: Analysis of EU/UK ETS Data

## A 7.1 INTRODUCTION

This annex summarises the analysis of the 2021 UK Emissions Trading System (UK ETS) energy and emissions data that is used within the compilation of the UK GHG inventory. The UK ETS replaced the UK's participation in the EU Emissions Trading System at the end of the transition period on 31 December 2020<sup>40</sup>, as such data for 2005 to 2020 is part of the EU ETS and data for 2021 onwards is part of the UK ETS. The ETS data are used to inform activity data estimates for heavy industry sectors, carbon dioxide emission factors of UK fuels within those sectors, and for comparison of fuel allocations to specific economic sectors against data presented in the *Digest of UK Energy Statistics* (DUKES), published by the Department of Business, Energy and Industrial Strategy (BEIS).

The ETS data are used in the UK GHGI compilation as follows:

- ETS raw data on energy and emission estimates are processed and checked to enable integration of the activity data, implied emission factors and installation emission estimates as far as practicable within the UK GHG inventory compilation. Emission sources reported in ETS are allocated to inventory fuels and source codes, outliers are identified, and clarifications of data inconsistencies are sought with the regulatory agencies;
- ETS activity data are closely compared against the UK national energy balance (DUKES) published by BEIS, and any inconsistencies are researched, seeking to resolve these through consultation with BEIS wherever possible;
- The verified ETS data provides up to date high quality fuel compositional analysis of UK fuels, and these data are used to improve inventory emission estimates across the highly energy intensive sources such as power stations, refineries, cement kilns, and oil and gas sources;
- The ETS dataset for offshore oil and gas installations are checked to assess data consistency in emissions reporting between the ETS and the EEMS dataset which is also used within the UK GHGI compilation;
- Overall, the Inventory Agency approach seeks to minimise data discrepancies between EU/UK ETS and the GHGI as far as practicable, in order that the derivation of traded and non-traded emission estimates from the UK GHGI are as accurate as possible. Close consistency between the ETS and GHGI is an important aspect of the development of a complete and consistent evidence base for policy development and tracking progress towards UK GHG reduction targets in the non-traded sector under the EU Effort Sharing Decision.

The scope of reporting under EU ETS increased from the 2013 dataset onwards. Phase II of the EU ETS ran from 2008-2012 inclusive. Phase III reporting began in 2013, with some new emission sources and new installations reporting for the first time on their GHG emissions; in particular, the

---

<sup>40</sup> There are also 5 power generating stations in Northern Ireland that do not currently participate in the UK ETS as they remain as participants in the EU ETS, under the terms of the Northern Ireland Protocol, to protect the operation of the Single Electricity Market on the island of Ireland.



definition of combustion has now been extended to cover installations such as furnaces, driers, and other plant where heat is used directly. A handful of industrial process sources of CO<sub>2</sub> are also included from 2013, such as soda ash production. In the UK, the changes in reporting in Phase III are most significant for the chemicals sector, where the scope of reporting is larger than previously and now encompasses both new industrial process emission sources, and additional energy use. There is also a notable shift towards estimation methods that are based on mass balance calculations (e.g. for chemical manufacturing) within the UK operator reporting to EU ETS. Other sectors with significant increases in reporting are food and drink manufacture, where installations such as driers, ovens etc. were included for the first time thus adding to the emissions from boilers and CHP plant that were reported in previous years, and roadstone coating, a sector which has not been present in the dataset before.

Analysis of the phase III data enabled the Inventory Agency to improve estimates of emissions from the combustion of waste residues and process off-gases within the chemical and petrochemical sectors (which are all reported under IPPU sector 2B10), as well as to generate improved estimates for the IPPU component of several specific manufacturing processes, such as for soda ash (2B7), and titanium dioxide (2B6). In addition, following a review of methodology for all IPPU sources, EU/UK ETS data for phase II onwards has been used to improve emission estimates for glass production (2A3), brickmaking (2A4) and reductant use in electric arc furnaces (2C1).

The key findings from the analysis and use of the EU/UK ETS data include:

- In the 2021 ETS dataset, a very high coverage of Tier 3 emissions data is evident for all fuel use in the power sector, and for solid, liquid and waste-derived fuels used in the cement and lime sectors. The proportion of Tier 3 data is somewhat lower for refinery fuel use, but still sufficiently high for the ETS to be considered the most reliable data available. All of the fuel quality data for these sources and fuels are therefore used within the UK GHGI, as the ETS fuel quality data is the most representative dataset available to inform UK carbon dioxide emission factors in the inventory;
- ETS emissions data from refineries are higher than estimates derived from DUKES activity data for all but two years within the time series, with a discrepancy evident in OPG emissions. Consultation with the industry trade association, UKPIA, and cross-checking with their data shows that the ETS data are felt to more accurately reflect estimates of CO<sub>2</sub>, and therefore UK GHGI estimates are based on EU/UK ETS data rather than refinery fuel use data reported in the UK energy balance;
- There are a range of other activity data discrepancies when compared to DUKES within the oil & gas, cement and lime, other industry and iron and steel sectors. Revisions to fuel allocations within the UK GHGI have been implemented for a number of sources, whilst further research is needed in some instances to clarify the issues where the reporting format of EU/UK ETS does not map explicitly to energy balance and GHG inventory reporting requirements;
- EU/UK ETS data for fuel use at chemical and petrochemical production facilities has helped to identify and quantify the combustion of process off-gases that are derived from Natural Gas Liquid (NGL) feedstock to petrochemical production processes, and from combustion of carbon-containing process residues. Analysis of “fuel gas” calorific values and carbon content informs the calculations to estimate emissions from NGL-derived gases and other residues.

The use of EU/UK ETS data in the UK GHG inventory is summarised in **Table A 7.1.1**.

**Table A 7.1.1 Summary of the use of EU/UK ETS data in the UK inventory**

Category	Sub-categories	Factors	Activity	Emissions	Comments
1A1a	Power stations - coal, fuel oil natural gas, sour gas	✓			
1A1a	Power stations – petcoke			✓	Some additional data is sourced from process operators.
1A1b	Refineries – petcoke & OPG			✓	EU/UK ETS figures only used where higher than DUKES-based emissions.
1A1b	Refineries – natural gas	✓			
1A1c 1B2	Upstream oil and gas production – Gas oil, natural gas, LPG, OPG			✓	
1A1c	Gas industry – natural gas		✓		
1A1c 1B1b 1A2a 2C1	Integrated steelworks	✓	✓		Use of various EU/UK ETS data in complex carbon balance – factors for some fuels, activity data for others
1A1c	Collieries – Colliery methane	✓			
1A2b	Autogenerators - coal	✓			
1A2f	Lime - coal			✓	
1A2f	Lime – natural gas		✓		
1A2g	Industry - petcoke & waste solvents			✓	No alternative data available for this emission source.
1A2g	Industry – colliery methane	✓			
2A1	Cement			✓	Data used is actually from industry trade-association, but this is based on EU/UK ETS returns
2A2	Lime			✓	
2A3	Glass			✓	

Category	Sub-categories	Factors	Activity	Emissions	Comments
2A4	Bricks			✓	
2B7	Soda ash			✓	
2B8g	Ethylene & other petrochemicals			✓	
2C1	Electric arc furnaces - reductants			✓	

## A 7.2 BACKGROUND

### A 7.2.1 EU/UK ETS Data and GHG Inventories

The UK ETS and EU ETS data provide annual estimates of fuel use and fuel quality data from the most energy intensive sites in the UK, and provides a source of data - or can be used to cross-check data held in the UK Greenhouse Gas Inventory (GHGI) - to inform the carbon contents of current UK fuels. The EU ETS has operated since 2005, and data has been available on an annual basis since this time across major UK industrial plants. The UK ETS replaced the UK’s participation in the EU ETS at the end of the transition period on 31 December 2020.

The data reported under the EU/UK ETS includes quantities of fuels consumed (or other activity data for process sources of CO<sub>2</sub>), carbon contents of fuels and other inputs, calorific values (fuels only) and emissions of carbon dioxide, all presented by installation and by emission source. Activity data are also given for many biofuels, although emissions of CO<sub>2</sub> from these fuels are not included in the emissions data. This is useful though, since PI/SPRI/WEI/NIPI emissions data for CO<sub>2</sub> often include biocarbon as well as fossil carbon, and the EU/UK ETS data on biofuels helps to explain differences between CO<sub>2</sub> emissions reported in EU/UK ETS and in those regulator inventories. EU/UK ETS data for individual installations are treated as commercially confidential by the UK regulatory authorities and so only aggregated emissions data are reported in inventory outputs.

As part of the UK’s annual reporting requirements to the MMR and UNFCCC, the UK must include a comparison of the EU/UK ETS data against the national inventory dataset within the National Inventory Report. Furthermore, the analysis of the inventory against the EU/UK ETS dataset is coming under increasing scrutiny due to the development of domestic GHG reduction targets that are based on non-traded<sup>41</sup> emissions data only, and the growing need to understand the UK non-traded sector emissions for future reporting under the Effort Sharing Decision.

The EU/UK ETS dataset helps to improve the UK GHG inventory in a number of ways:

- Identifying new sources, therefore improving completeness;

---

<sup>41</sup> All GHG emissions that are regulated within the EU/UK ETS are defined as “traded” emissions, whilst all other GHG emissions are defined as “non-traded”. The EU Effort Sharing Decision has led to the UK adopting a new target for GHG reductions by 2020 for all of the non-traded emissions (i.e. everything outside of EU ETS), and progress towards this target will be monitored through the UK GHG inventory.

- Helping assess true levels of uncertainty in fuel- and sector-specific data;
- Providing fuel quality data and oxidation factors for complex processes;
- Providing information on process-specific emissions that are not apparent from the national energy balances;
- Reducing uncertainty in the GHGI; and
- Acting as a source of quality assurance to inventory data.

In the 1990-2021 inventory cycle, the Inventory Agency has updated and extended the EU/UK ETS analysis conducted for inventory compilation, using the 2021 UK ETS dataset, which is the first since exiting the European Union. This annex presents a comprehensive review of the seventeenth year of ETS data, indicating where the data have already been used in the improvement of the GHGI, as well as highlighting outstanding issues which could be investigated further, with potential for further revision and improvement of the GHGI.

The Inventory Agency has also been provided with details of all offshore oil and gas installations from EU/UK ETS data since 2011, which are regulated by BEIS OPRED. Access to these detailed data has enabled a more thorough review of the fuel/gas quality and reported emissions from combustion and flaring sources at offshore installations, and has directly improved the completeness and accuracy of the sector estimates within the UK GHGI.

The analysis of the EU/UK ETS data for use in the UK GHGI necessitates a detailed review of the available data, in order to ensure correct interpretation and application of the available data. The study team prioritises effort to the sources and sites that are the most significant in UK GHGI terms, and/or where data reporting discrepancies have been identified from previous work. For those sectors where EU/UK ETS data are used in the GHGI, it is important to review emission factors from all major installations to ensure that any outliers are identified and checked prior to their inclusion in inventory calculations.

Wherever possible, consistent assumptions are made when interpreting data across all years of the EU/UK ETS. For instance ensuring that each site is allocated to the same inventory sector in each year (unless there is reason to change it – some industrial combustion plants in recent years have been converted into power stations, and so these sites do need to be allocated to different sectors in different years), and that there is consistency in the way in which site-specific names for fuels are interpreted across the entire period. The information on the EU/UK ETS method “Tier” used for each of the data dictates whether they are used in inventory compilation. The highest tier EU/UK ETS data are assumed to be subject to the lowest level of uncertainty, and so only tier 3 and tier 4 emission factor data are used. Occasionally there are internal inconsistencies in the EU/UK ETS data between the data on consumption of a given fuel and emissions from the use of that fuel. These need to be resolved before the data can be used in the UK GHGI. As emissions data are verified, we cross-check the detailed emissions data against the final verified emissions for each site. As a general rule it is found that the most appropriate solution to inconsistencies is to assume that the EU/UK ETS emissions data are correct as EU/UK ETS reporting requirements are well regulated, and that it is the activity data that need to be amended instead.

### **A 7.2.2 Scope of the EU/UK ETS and Implications for the GHG Inventory**

There are a number of limitations to the EU/UK ETS data that affect the data usefulness in GHG inventory compilation, including:

- The EU/UK ETS data are only available from 2005 onwards, whilst the UK GHG inventory reports emission trends back to 1990. The additional information that EU/UK ETS provides (e.g. year-specific emission factors for many fuels in energy intensive sectors) helps to reduce the uncertainties in inventory emission estimates for the later years, but care is needed where revisions to the time series are made back to 2005. A consistent approach to inventory compilation across the time series is a key tenet of IPCC good practice guidance, and care is needed to ensure that the use of EU ETS data does not introduce a systematic reporting step-change in the UK GHGI;
- Further to this point, it is important to note that the scope of EU ETS reporting has evolved through the years, from Phase I (2005 to 2007) into Phase II (2008 to 2012 data) and now to Phase III (2013 onwards). The comparability of EU ETS data for many sectors is poor between these three phases. For example, many cement kilns did not report to EU ETS until Phase II: several sectors including cement were reporting under Climate Change Agreements and were opted-out of EU ETS during Phase I. Therefore, in several sectors, more complete coverage of EU ETS reporting is evident in Phase II and data from 2008 onwards are therefore much more useful for UK GHGI reporting. The scope of coverage of chemical industry emissions has gone through two step changes – in 2008, and again in 2013, and some sectors (such as roadstone coating) only appear for the first time in the 2013 EU ETS data. Less significantly for the GHGI, many small installations, mostly in the public sector, were removed from EU ETS at the end of phase I. It is vital that the GHGI takes full account of such changes and that UK inventory data do not include trends that merely result from the increase (or decrease) in scope of EU/UK ETS. The changes in EU ETS scope have made the data set increasingly useful, and there are now five years' worth of Phase II data, eight years of data under Phase III, and the first year of UK ETS, hence the EU/UK ETS dataset is now an important source of information for the UK inventory;
- In the UK during EU ETS Phases I and II, the regulators adopted a “medium” definition of the term “combustion”, and as a result there were many sectors where fuel use in specific types of combustion unit were not included in the EU ETS reporting scope until the start of Phase III (2013). Examples of this include flaring on chemical sites, and fuel use in heaters, dryers, fryers and stenters in industry sectors such as: chemicals, food and drink, textiles, paper and pulp. Hence the total fuel use and GHG emissions from these sectors have typically been under-reported within the EU ETS historically compared with the UK inventory, with many sites and sources excluded from the scope of EU ETS. However, the ETS data for these sectors is also incomplete both in Phase II, Phase III and UK ETS because small installations are not covered by EU/UK ETS. Therefore, while the change in scope for combustion installations in phase III is a positive step, it has relatively little impact on the data used in GHGI compilation. Some Phase III data has been used to improve the estimates of emissions from combustion of process wastes / off-gases in the chemical and petrochemical sector in the recent submissions.
- Phase III also brought an increased scope for industrial process sources of CO<sub>2</sub>, and data appeared for the first time for soda ash production, and titanium dioxide manufacture.
- When using the EU/UK ETS data, assumptions and interpretations are required to be made regarding the fuel types used by operators; assumptions are made on a case by case basis depending on knowledge of the site or industry and expert judgement. Operators are free to describe fuels as they wish in their returns, rather than choosing from a specific list of fuels, and so assumptions occasionally need to be made where the fuel type used is not clear from the operator's description. This issue was more significant

in the earlier years of EU ETS reporting, with operators often using terms such as “Fuel 1”. The assumption then made about fuel type was based both on the other data the operator provided on the fuel such as calorific value, but also by comparison with later data for the same site, since operators now tend to use more recognisable fuel names, and the use of wholly ambiguous terms is now very rare.

Note that:

- The direct use of EU/UK ETS data (e.g. fuel use data by sector) to inform UK GHGI estimates is limited to where the EU/UK ETS is known to cover close to 100% of sector installations. For example, the EU/UK ETS is regarded as representative and 100% comprehensive in coverage of refineries, power stations (except in the case of some small power stations burning biomass, gas oil, or burning oil as the main fuel), integrated steelworks, cement and lime kilns, soda ash plant, titanium dioxide plant, petrochemical works and glassworks (container, flat, wool & continuous filament fibre only – small lead glass and frit producers are not included). Coverage is very close to 100% for brickworks and tileries. For many other industrial sectors (such as chemicals, non-ferrous metals, food and drink, engineering) the EU/UK ETS is not comprehensive and therefore the data are of more limited use, mainly providing a de-minimis fuel consumption figure for these sectors.
- EU/UK ETS Implied Emissions Factors (IEFs) can be used within the UK GHGI, but only where the evidence indicates that EU/UK ETS data are representative of the sector as whole and provides more comprehensive and accurate data than alternative sources. The key criteria to consider in the assessment of EU/UK ETS IEF usefulness is the percentage of annual fuel use by sector where operator estimates use Tier 3 emission factors.
- Review of the EU/UK ETS IEFs for different fuels across different sites provides a useful insight into the level of Tier 3 reporting within different sectors, the progression of higher-Tier reporting within EU/UK ETS through the time series and the level of variability in fuel quality for the different major fuels in the UK. As a general rule, those energy-intensive sectors with near 100% coverage in EU/UK ETS also report a very high proportion of emission factor data at Tier 3. Those sectors with incomplete coverage tend to report most emission factor data below Tier 3. As a result, in all cases where the level of sectoral coverage is high, the quality of reported data is also sufficiently high to be used with confidence in the UK inventory.

### **A 7.2.3 Limitations of EU/UK ETS Data Integration with GHG Inventory: Autogeneration**

Despite detailed research there remain some fundamental limitations in the use of EU/UK ETS data within national inventories where the sector allocation of energy use and emissions cannot be resolved against the national energy statistics that underpin the GHG inventory compilation. One key example is that of the division between fuel use in autogeneration (or heat generation) and direct fuel use within a specific sector. For example, based on the data available from EU/UK ETS, it is impossible to differentiate between gas use in autogeneration on a chemical installation, and gas used directly to heat chemical production processes. In this example, the allocation of EU/UK ETS energy use and emissions between 1A2c (chemicals) and 1A2f (autogenerators) is uncertain, and therefore comparison of EU/UK ETS and GHGI estimates is uncertain. The EU/UK ETS data are not sufficiently detailed and transparent to enable accurate allocation, and so in all cases fuels and emissions are allocated to the industry sector, and not to autogeneration.

It is worth noting here that the UK energy statistics are also subject to some uncertainty, however small, and that there is likely to be more uncertainty in estimates at industrial sector-level, rather than at more aggregated levels. For example, while fuel producers and suppliers will be able to quantify total fuel demand with a high level of certainty, it would be far more difficult for them to estimate fuel use by specific industrial sectors. This will be reflected in the quality of UK energy statistics which are used to estimate emissions from 1A2c etc. We consider that a high proportion of fossil fuel use by the UK chemical industry will be included in the EU/UK ETS, on the basis that most industrial chemical processes will require sufficiently large combustion installations to exceed the threshold for EU/UK ETS. Therefore, we consider that it is reasonable to assume that EU/UK ETS emissions for the chemical sector should cover most of the sector and therefore be similar in magnitude to those estimated from UK energy statistics and even, given the uncertainty in fuel allocation for autogeneration, to exceed them. For other sectors such as metals, paper, and food and drink, we would assume that the level of sectoral coverage by the EU/UK ETS would be lower, so that emission estimates based on EU/UK ETS would probably be lower than those based on energy statistics, even taking into account the uncertainty regarding autogeneration.

### **A 7.2.4 Data Processing**

BEIS provided the detailed UK ETS regulator data from the Environment Agency, Natural Resources Wales, Scottish Environment Protection Agency, Northern Ireland Environment Agency, and the Offshore Petroleum Regulator for Environment and Decommissioning in May 2022, and the Inventory Agency industrial emissions experts progressed the analysis, combining the datasets to generate a UK-wide UK ETS dataset. The work built on analysis conducted in previous years, as the EU ETS has been in place since 2005, but this latest analysis, while focussing on the latest year of data, did involve review of the data for earlier years, to ensure a consistent approach to the interpretation of energy and emissions data across the time series.

The initial step in the analysis is the allocation of all sites in the dataset to one of the economic sectors as reported within the DUKES Commodity Balance tables. Next, the reported fuels for every UK installation have to be allocated to one of the GHGI fuel names, which are also aligned with the fuel types reported within DUKES. This enables a direct comparison of UK ETS fuel totals against sector fuel allocations within DUKES and therefore used within the GHGI.

Most of the allocations have been made as part of previous years' work, and do not need to be revisited. However, several new installations included in the 2021 UK ETS data had to be allocated to DUKES' sectors, and all of the fuel data for 2021 also has had to be allocated to DUKES/GHGI fuel types. In a very small number of cases, we have revised data for earlier years, for example when it has become apparent that existing assumptions are likely to be incorrect. The allocation process does rely upon some expert judgement, with the Ricardo team using the reported UK ETS fuel names as well as the reported fuel quality data such as calorific values and carbon emission factors in order to make the fuel-type allocation for each entry in the UK ETS spreadsheet. The allocation is, occasionally, quite uncertain, particularly with the allocation of petroleum-based fuels such as the GHGI fuel categories LPG, OPG, gas oil and fuel oil, often because of the use of abbreviations or other slightly ambiguous names for fuels within the UK ETS reporting system. Cross-checking of data across the time series for each installation has been used to ensure as much consistency in fuel allocations as possible, although in some cases, operators of installations use different fuel terminology in different years, and the possibility of the use of different fuels in different years at a site cannot always be ruled out.

The quality checking and allocation process is very resource-intensive and essentially an open-ended task for such a large dataset, and hence the Inventory Agency focuses on the highest emitters and the known “problem” sites and fuel types. Where uncertainties arise in allocations, the most important allocation decisions are copied across to the BEIS DUKES team, for their information and input, as ultimately the UK ETS analysis by the Inventory Agency is taken into account to some degree within the compilation of DUKES for the following year.

As a data verification step, the installation emissions (broken down by fuel) from the EU ETS regulator spreadsheets are then compared against the total installation emissions for 2021 on the European Union Transaction Log (EUTL) which is a central website that holds the verified EU ETS emissions totals for all EU installations in the scheme. The UK ETS Public Reports website holds the equivalent Compliance Report on emissions for the UK ETS. We have noted that for some sites the regulator data does not match the EUTL/Compliance Report datasets, and therefore some “residual” emissions allocations are generated, from the difference between these datasets and regulator information. In cases where these residual emissions are large, these are fed back to the regulator contacts, for their consideration and to request any insights into the likely fuels that the residual emissions should be allocated against. Minor residual emissions are ignored for the purposes of the analysis reported here.

A final data set is then available for fuel combustion emission sources, which includes the following data fields:

- GHGI Source Category;
- GHGI Fuel Category;
- Fuel Consumed;
- Fuel Calorific Value;
- Fuel Carbon Emission Factor; and
- Related Emissions of CO<sub>2</sub>

The Inventory Agency then combines the data by sector and/or fuel category to provide data for comparison against GHGI emissions data, and energy statistics published in DUKES. In this way, the analysis can:

- provide improved CO<sub>2</sub> emission factors for highly energy-intensive industrial sectors covered by the GHGI through the use of verified data;
- provide a comparison with UK energy statistics, allowing the identification of inconsistencies between EU/UK ETS and DUKES;
- Identify any emission sources that are not contained in the GHGI.

The analysis of the UK ETS data for all onshore facilities was completed by May 2022 and provided to the BEIS team of energy statisticians, in time for them to consider the UK ETS dataset during compilation of the UK energy balance for 2021, as published within DUKES (published in July 2022).

The UK ETS data for offshore oil and gas installations was provided in May 2022 and were used directly in the compilation of emission estimates for the upstream oil and gas sector, after the UK energy balance had been compiled by BEIS. Access to these UK ETS data for offshore facilities provided more fuel-specific information (GCV, carbon content) to help improve completeness and accuracy of the upstream oil and gas estimates in the UK GHGI, augmenting the EEMS dataset



which is a more comprehensive dataset (i.e. EEMS covers more emission sources than UK ETS) but does not provide the same level of fuel-specific data.

### A 7.3 EU/UK ETS DATA COVERAGE

The coverage of the EU ETS data has changed over the years for which data are available. Major changes have been outlined in **Section A 7.1**, and these changes in scope have an impact on the usefulness of data for some sectors, with data generally being more complete for Phase II (2008-12) and Phase III (2013-2020) of EU ETS. In addition, smaller combustion installations in the industrial, commercial and public sectors are outside the scope of EU ETS, and in fact coverage was decreased after 2007 due to the exemption of certain 'small emitters' from the UK EU ETS. For some source sectors in the GHGI, the EU ETS data therefore only includes a small proportion of the sector and the EU ETS data are not useful to directly inform the GHGI.

The following GHGI source sectors are well represented in the EU/UK ETS data sets in the UK, with all UK installations included:

- Power stations burning coal, gas, and fuel oil as the principal fuel;
- Oil refineries;
- Coke ovens & Integrated steelworks;
- Cement kilns (from Phase II onwards); and
- Lime kilns (from Phase II onwards)
- Glassworks - container, flat, wool & continuous filament glass fibre subsectors only (from phase II onwards)
- Brickworks and other sites manufacturing heavy ceramic goods (from Phase II onwards)
- Titanium dioxide and soda ash manufacture (from Phase III onwards).

However, GHGI sectors such as industrial combustion, autogeneration, and public sector combustion are only partially represented in the EU/UK ETS data. An indication of the actual level of coverage of the EU/UK ETS data can be seen in **Table A 7.3.1**. The number of sites in each sector which are included in the ETS dataset for 2005 and 2021 are given, together with the Inventory Agency's estimate of the total number of installations in that sector throughout the UK in those years.

**Table A 7.3.1 Numbers of installations included in the EU/UK ETS data**

Sector	EU ETS installations in 2005	Total installations in 2005	UK ETS installations in 2021	Total installations in 2021
Power stations (fossil fuel, > 75MWe)	60	60	49	49
Power stations (fossil fuel, < 75MWe)	23	27	14	37
Power stations (nuclear)	12	12	7	7
Coke ovens	4	4	2	2
Sinter plant	3	3	2	2

Sector	EU ETS installations in 2005	Total installations in 2005	UK ETS installations in 2021	Total installations in 2021
Blast furnaces	3	3	2	2
Cement kilns	8	15	11	11
Lime kilns	4	15	13	13
Refineries	12	12	8	8
Combustion – iron & steel industry	11	200 <sup>a</sup>	25	200 <sup>a</sup>
Combustion – other industry	171	5000 <sup>a</sup>	445	5000 <sup>a</sup>
Combustion – commercial sector	28	1000 <sup>a</sup>	100	1000 <sup>a</sup>
Combustion – public sector	169	1000 <sup>a</sup>	93	1000 <sup>a</sup>
Glassworks (flat, special, container & fibre)	6	32	23	24
Brickworks	18	80 <sup>b</sup>	48	48
Soda ash & titanium dioxide	0	4	4	4

<sup>a</sup> These estimates are 'order of magnitude' figures, based on expert judgement of the inventory team, to show that the number of installations in the UK is likely to be considerably higher than the number of installations reporting in the EU/UK ETS.

<sup>b</sup> Numbers of brickworks are not certain in 2005 but will have been significantly higher than in 2008 (when there were about 70) since many brickworks were closed or mothballed in the second half of 2007. All brickworks are believed to be covered by UK ETS in 2021.

Data are included in EU/UK ETS for all coke ovens, refineries, sinter plant and blast furnaces. Power stations are divided into three categories in the table in order to show that, although a few stations are not included in the UK ETS data for 2021, these are all small (in most cases, very small diesel-fired plant supplying electricity to Scottish islands). In comparison, coverage is quite poor in 2005 for cement and lime kilns (due to CCA participants opting out during Phase I) and for combustion processes (due to CCA/UKETS opt-outs and the fact that numerous combustion plant are too small to be required to join the EU/UK ETS). All cement kilns and all lime kilns are included in 2021. Coverage of glassworks and brickworks was very limited during Phase I, but since 2008 has been very good: all large glassworks have been included since 2008, and all but one brickworks were included in Phase II, with that remaining site being added for Phase III. UK totals for brickworks are subject to some uncertainty however, and may be revised in future should more data be obtained. Both soda ash plant and both plants manufacturing titanium dioxide via the chloride process have only been included in EU ETS since the start of Phase III.

For most emission sources the level of detail given in the EU/UK ETS data matches well with the structures of the GHGI, allowing comparison of like with like. Only in the case of coke ovens and integrated steelworks is this not the case, since the EU/UK ETS reporting format does not provide a breakdown of emissions for the sectors reported within the GHGI: i.e. estimates of emissions from coke ovens, blast furnaces and sinter plants are not provided explicitly. However, for these sectors, additional detailed analysis, including the collection of other industry data, has allowed for far greater use of EU/UK ETS data for the inventory.

### A 7.3.1 EU/UK ETS Data Use in the UK GHGI

The use of EU/UK ETS data in the UK GHGI may conveniently be divided into two classes:

- Instances where activity data and, in most cases, emission totals as well are taken from EU/UK ETS;
- Instances where emission factors only are taken from EU/UK ETS and then used in the UK GHG Inventory with activity data from other sources such as DUKES.

### A 7.3.2 Activity and Emissions Data

#### A 7.3.2.1 Crude Oil Refineries

The comparison of EU/UK ETS emissions data against GHGI data based on DUKES fuel use allocations for petcoke, natural gas, fuel oil and OPG use is inconsistent to varying degrees in different years. Previous EU ETS analysis indicated that petcoke data in DUKES were too low; the BEIS energy statistics team have investigated this matter with the refinery operators and have revised data for a number of sites that had been misreporting through the DORS system used to compile DUKES. In recent years, therefore, the EU and UK ETS and DUKES data are closely consistent for petcoke use by refineries.

Data inconsistencies between DUKES and EU/UK ETS remain for other fuels, however, in some cases, this will be due to misallocation of fuel use data within the EU/UK ETS analysis, where fuel names are unclear, e.g. “fuel gas” could be interpreted solely as refinery use of OPG or to also cover the use of natural gas as a back-up fuel within the refinery fuel gas system.

The fuel oil activity data in most years is around 10% higher in EU ETS than in DUKES. Natural gas is a relatively minor fuel in the sector; whilst the EU ETS allocations indicate an over-report in DUKES, there is considerable uncertainty over the allocations of gases in the EU ETS dataset, as noted above. However, DUKES data for natural gas used in autogeneration includes some fuel burnt at refineries, thus the difference between refinery fuel use as given in EU ETS, and that derived from DUKES data can be reduced by taking this into account. Consumption of naphtha reported in DUKES as “unclassified industry” is allocated to refineries as the only known consumers in the UK. However, in the case of OPG, there is typically an under-report in DUKES, although the data in DUKES is higher in two years. **Table A 7.3.2** below presents the emissions allocated to OPG for those years (2004 onwards except 2005, 2012) where UKPIA and EU ETS data indicates that DUKES data are too low. Note that the GHGI estimates also include the assumption that all of the OPG allocation to “autogenerators” within the DUKES commodity balance tables (in the column “Other gases”) is used within the refinery sector. Consultation with the BEIS DUKES team has indicated (Personal Communication, Evans, 2010) that the “Other gases” column in the Commodity Balance tables is the OPG on the refinery basis, with CHP plant on site allocated to the autogeneration line. We have therefore retained this assumption in the current analysis, including the autogenerator allocation of “other gases” within the refinery sector.

To resolve the refinery sector under-report, we have compared DUKES data against EU/UK ETS data, and also considered the total carbon dioxide emissions for the refinery sector provided annually by UKPIA. At the installation level, the UKPIA and EU/UK ETS data show very close consistency for recent years (typically within 1%). The close consistency of the EU/UK ETS and UKPIA data further strengthens the case for using EU/UK ETS data as the primary dataset to inform the UK GHG inventory, in preference to the DUKES energy statistics.

At the fuel-specific level, the greatest disparity is evident in the reporting of OPG use at refineries; the reporting disparity has therefore been resolved through a top-down emissions comparison between DUKES-derived data and the best available operator data from EU/UK ETS (2005 onwards) and UKPIA (pre-2005), with the difference between the two then allocated to OPG use in the UK GHGI. UK inventory estimates of emissions for the sector are therefore aligned with EU ETS totals back to 2005, and with UKPIA data prior to 2005, unless the estimates derived from DUKES data are higher than those from UKPIA or EU ETS (i.e. in 2005 and 2012).

No deviations from UK energy statistics have been made prior to 2004, as the data from UKPIA and GHGI estimates based on DUKES are closely consistent with the DUKES-derived data being slightly higher; therefore, a conservative approach is adopted, using DUKES-derived GHG estimates.

The time series of emissions data and the additional OPG and petroleum coke emissions data (where DUKES data are low) for the sector are shown below.

**Table A 7.3.2 Refinery Emissions Data Comparison and Revision to OPG Activity**

Year	Best Operator Data <sup>1</sup> kt C	Refinery emissions total (if based on DUKES) kt C	Additional emissions assumed from OPG kt C	Additional emissions assumed from Petcoke kt C
2000	3,467	4,718	-	-
2001	3,669	4,665	-	-
2002	4,118	5,244	-	-
2003	4,052	5,084	-	-
2004	3,980	4,925	74	-
2005	5,007	5,275	-	150
2006	4,910	4,674	160	76
2007	4,857	4,729	77	50
2008	4,709	4,348	240	121
2009	4,492	4,000	366	126
2010	4,632	4,349	207	76
2011	4,739	4,490	249	-
2012	4,287	4,299	-	-
2013	4,002	3,852	148	2
2014	3,678	3,558	120	-
2015	3,682	3,610	26	47
2016	3,708	3,497	155	56
2017	3,698	3,511	174	12
2018	3,559	3,506	33	19
2019	3,444	3,413	31	-
2020	3,030	2,798	232	-

Year	Best Operator Data <sup>1</sup> kt C	Refinery emissions total (if based on DUKES) kt C	Additional emissions assumed from OPG kt C	Additional emissions assumed from Petcoke kt C
2021	3,022	2,809	213	-

<sup>1</sup> For 2005 onwards, the EU/UK ETS data are verified by third parties and regarded as the best available sector estimates; prior to 2005 the best available operator emissions data are from the trade association, UKPIA.

<sup>2</sup> For 2005, DUKES activity data for petroleum coke are somewhat lower than the corresponding figure in the EU ETS, so even though CO<sub>2</sub> emission estimates based on DUKES figures for all fuels exceed the CO<sub>2</sub> figure given in the EU ETS, we use the higher (EU ETS) figure for petroleum coke, with the result that for 2005, the UK inventory figure for refinery CO<sub>2</sub> is higher (at 5422 kt C) higher than either the operator or DUKES based totals.

There is some level of uncertainty in the allocation of fuels in EU ETS to specific “DUKES” fuels, although the OPG use in refineries seems to be reported quite consistently as “Refinery Gas”, “Refinery Off-Gas”, or “OPG/RFG”. The BEIS DUKES team have reviewed the year to year consistency of OPG use in refineries through the DORS system.

### **A 7.3.2.2 Natural Gas Use by Downstream Gas Supply Installations**

The EU/UK ETS data includes natural gas use by large gas compressor and storage sites that operate on the UK gas transmission and distribution network, as well as the three operational LNG terminals and a small number of other downstream gas industry sites.

The gas use reported in EU/UK ETS for these sites from Phase II onwards has been notably higher than the allocation of gas within DUKES Commodity Balance Table 4.2 (Energy Industry Use, Other). This has been evident in the traded / non-traded analysis for the gas supply sector in the UK and Devolved Administrations GHGI.

As this gas use arises from the downstream network, the Inventory Agency and the BEIS DUKES team consider that the DUKES data indicate a small misallocation of gas use, rather than a gap in reported gas use. For 2005 to 2019, therefore, the EU ETS data for this source are used within the UK GHG inventory, and the overall gas use data are balanced by reducing the allocation of gas use to “other industrial combustion” (IPCC source 1A2g); the EU ETS data since 2005 shows good consistency with the data from DUKES for earlier years.

The increased gas use for this sector based on EU/UK ETS data is expected to still be a small under-report for the sector as a whole, as the EU/UK ETS scope only includes around 35 of the larger gas compressors, LNG terminals and storage sites on the UK network, and it is likely that additional gas use on smaller sites also occurs. However, the Inventory Agency has no data to inform such estimates.

### **A 7.3.2.3 Other Industry OPG use**

There are a number of “other industry” sites where OPG use has been allocated by the Inventory Agency from EU/UK ETS data, where the fuel is defined as either a specific gas (e.g. ethane, propane, butane) or more generic terms such as “OPG”, “High Pressure Refinery Gas”, “Low Pressure Refinery gas”, “fuel gas” or “RFG/OPG/ROG” within the EU ETS forms.

In refinery complexes, the use of RFG for autogeneration (for the refinery and/or for co-located plant) is reported within the energy balance (allocated to “OPG”). At a number of other UK installations, commodities that are used initially as feedstocks in chemical and petrochemical production (e.g. naphtha, ethane, LPG, gas oil) are allocated to “non-energy use” in the UK

energy statistics; any subsequent use of process off-gases (derived from these NEU feedstocks) as a fuel is not reflected in DUKES. Therefore, the Inventory Agency uses other data from industry, primarily from EU/UK ETS, to generate estimates of the use of such secondary fuels. For a small number of sites, consultation with the DUKES team, regulators and operators has clarified that the EU/UK ETS energy and emissions data are the best available dataset for use in the UK GHGI.

In the 1990-2021 inventory cycle, EU/UK ETS data for fuel use at petrochemical production facilities helped to identify and quantify the combustion of process off-gases that are derived from Natural Gas Liquid (NGL) feedstock to petrochemical production processes. Analysis of “fuel gas” calorific values and carbon content informs the calculations to estimate emissions from NGL-derived gases and other residues.

#### **A 7.3.2.4 Industrial Processes**

The EU/UK ETS dataset contains data on several industrial processes for which alternative data sources are either unavailable or of low quality. The EU/UK ETS data therefore constitute the most reliable set of emissions data for these processes and are used in the UK inventory. In almost all cases, the EU/UK ETS activity data are difficult to use directly, largely because different operators provide activity data and emission factors on a different basis (e.g. some may provide input material and emission factors on a consumption basis, others will provide production data and emission factors on a production basis). Therefore, for all of the industrial process sources, the EU/UK ETS emissions data are adopted, and activity data are generally back-calculated from the emissions using a suitable IPCC emission factor. The industrial process sources where EU/UK ETS data have been used to generate estimates of emissions included within the UK GHGI in this submission, include:

- Emissions from the manufacture of lime. UK activity data for limestone and dolomite consumption in lime production would yield much lower emission estimates than is suggested by EU/UK ETS returns therefore, as a conservative approach, the EU/UK ETS data are used instead. Activity data are back-calculated using the IPCC default factor for lime production. See **Section 4.3** for further details.
- Emissions from the use of carbonates in the manufacture of glass. As with lime production, the available data on consumption of limestone and dolomite for glass production are suspect, being very inconsistent across the time series, and so EU/UK ETS data are used in the generation of the inventory time series, as detailed in **Section 4.4**.
- Emissions from the use of clays, carbonate minerals and other additives in the manufacture of bricks and roofing tiles, as detailed in **Section 4.5**. The EU/UK ETS data are very detailed, with separate lines for different input materials such as different types of clay, carbonate minerals used in the bricks or in scrubbers used to abate fluoride emissions, and coke oven coke/petroleum coke used as an additive in certain bricks. UK brick production data are used as activity data.
- Estimates for emissions from the use of limestone in flue-gas desulphurisation (FGD) plant for the years 2005-2021 are taken from EU/UK ETS data, because UK activity data (for gypsum produced from the FGD plant) are incomplete for those years. Activity data for 1990-2004 are available from non-ETS sources and are back-calculated from the EU ETS CO<sub>2</sub> emissions for 2005 onwards assuming an emission factor of 253 kg CO<sub>2</sub> per tonne gypsum produced (which is based on an assumed 100% conversion of limestone and SO<sub>2</sub> into gypsum and CO<sub>2</sub>).

- EU ETS Phase III saw the introduction of data for soda ash manufacturing sites and EU ETS data, and CO<sub>2</sub> emissions reported for earlier years in the PI, are used as the basis of UK inventory emissions data for that sector. See **Section 4.12** for more details.
- Titanium dioxide production was also included in Phase III of the EU ETS, but full data for the UK plant are not included in the data set provided, and so emission estimates are generated using an alternative, more conservative method.
- For 2020, a stand-alone model was developed to estimate carbon emissions from the operation of Electric Arc Furnaces (EAFs). The objective of the model was to derive a time series of Emission Factors (EFs) per unit steel production to estimate annual GHG emissions, 1970 – latest year, for inclusion in the UK GHGI, to ensure completeness and to address any risk of under-reporting when comparing the UK GHGI against other data sources, including the EU/UK ETS. See **Section 4.16** for further details.

### A 7.3.3 Implied Emission Factors

#### A 7.3.3.1 Power Stations

**Table A 7.3.3** summarises EU/UK ETS data for fuels burnt by major power stations and coal burnt by autogenerators. The percentage of emissions based on Tier 3 emission factors is given (Tier 3 factors are based on fuel analysis and are therefore more reliable than emission factors based on default values), as well as the average emission factor for EU/UK ETS emissions based on Tier 3 factors.

**Table A 7.3.3 EU/UK ETS data for Fuels used at Power Stations and Autogenerators (Emission Factors in kt / Mt for Coal & Fuel Oil, kt / Mth for Gases)**

Year	Fuel	% Tier 3	Average Carbon Emission Factor (Tier 3 only)
2005	Coal	99	615.3
2006		100	615.0
2007		100	614.7
2008		100	612.4
2009		100	607.2
2010		100	609.0
2011		100	608.9
2012		100	611.7
2013		100	612.5
2014		100	611.8
2015		100	607.9
2016		94	612.3

Year	Fuel	% Tier 3	Average Carbon Emission Factor (Tier 3 only)
2017		100	613.0
2018		100	601.4
2019		100	608.9
2020		100	612.0
2021		100	587.3
2005	Fuel oil / Waste oil <sup>s</sup>	59	860.3
2006		66	873.0
2007		68	871.1
2008		91	869.5
2009		94	872.7
2010		95	873.3
2011		94	875.0
2012		96	873.4
2013		93	871.3
2014		92	871.8
2015		89	872.8
2016		91	876.9
2017		88	877.1
2018		81	874.2
2019		89	873.8
2020		89	877.3
2021		89	874.7
2005	Natural gas	52	1.443
2006		76	1.465
2007		95	1.464
2008		97	1.467
2009		100	1.464



Year	Fuel	% Tier 3	Average Carbon Emission Factor (Tier 3 only)
2010		99	1.460
2011		99	1.456
2012		100	1.461
2013		99	1.464
2014		100	1.461
2015		100	1.462
2016		99	1.462
2017		99	1.466
2018		99	1.465
2019		99	1.463
2020		100	1.459
2021		99	1.462
2005	Coal - autogenerators	100	594.3
2006		100	596.3
2007		100	594.5
2008		100	581.3
2009		100	600.6
2010		100	599.9
2011		100	594.9
2012		100	598.3
2013 onwards		0 <sup>b</sup>	N/A

<sup>a</sup> It is not possible to distinguish between fuel oil and waste oil in the EU/UK ETS data, so all emissions have been reported under fuel oil.

<sup>b</sup> Plant operated as a power station after 2012 and included in the figures for power stations burning coal

The EU/UK ETS data shown are regarded as good quality data, since a high proportion of emissions are based on Tier 3 emission factors (i.e. verified emissions based on fuel analysis to ISO17025). The factors are also very consistent across the time-series, which would be expected for this sector. As shown in Section 3, the EU/UK ETS data for power stations also cover almost

all UK installations in this sector, and certainly cover all of the installations which burn coal, fuel oil and natural gas.

A few power stations burn small quantities of petroleum coke as well as coal. One supplies data to ETS for coal/petroleum coke blends i.e. there are no separate emissions data or carbon factors for the coal and the petroleum coke at that site. We therefore back-calculate the coal IEF in those blends by using an assumed default for the petroleum coke carbon content and more detailed activity data on the constituents of the fuel blends, obtained directly from the operator.

The EU/UK ETS based emission factors presented above for power stations are used directly as the emission factors in the GHGI, with the exception of the 2005 figure for gas, where Tier 3 factors were only used for about half of the sector's emissions reported in EU ETS. Small quantities of sour gas were burnt at one power station in 2005-2007 and 2009 and EU ETS Tier 3 emission factors are available and therefore used. [Due to the confidentiality of the data, the emission factors are not shown]. Prior to 2005, the emission factors for these sectors are based on the methodology established by Baggott *et al*, 2004, since it has been concluded that this represents the most reliable approach.

The EU ETS factors for coal-fired autogenerators are slightly different to the factors for the power stations in that, although the EU ETS data are exclusively Tier 3, they only represent about 80-90% of total fuel used by the sector.

**A 7.3.3.2 Crude Oil Refineries**

**Table A 7.3.4** below summarises the EU/UK ETS data for the major fuels burnt by refineries in the UK.

The main fuels in refineries are fuel oil and OPG and emissions also occur due to the burning off of 'petroleum coke' deposits on catalysts used in processes such as catalytic cracking. In the latter case, emissions in the EU/UK ETS are not generally based on activity data and emission factors but are instead based on direct measurement of carbon emitted. This is due to the technical difficulty in measuring the quantity of petroleum coke burnt and the carbon content. Refineries also use natural gas, although it is a relatively small source of emissions compared to other fuels.

**Table A 7.3.4 Refinery EU/UK ETS Data for Fuel Oil, OPG and Natural Gas (Emission Factors in kt / Mt for Fuel Oil and kt / Mth for OPG and Natural Gas)**

Year	Fuel	% Tier 3	Average Carbon Emission Factor (Tier 3 sites only)
2005	Fuel Oil	25	860.9
2006		65	873.8
2007		78	877.2
2008		91	871.6
2009		91	876.2
2010		97	878.2
2011		85	45.3

Year	Fuel	% Tier 3	Average Carbon Emission Factor (Tier 3 sites only)
2012		82	887.1
2013		95	874.3
2014		96	875.8
2015		61	876.7
2016		66	876.1
2017		25	860.9
2018		65	873.8
2019		78	877.2
2020		100	871.8
2021		100	873.3
2005		OPG	56
2006	54		1.468
2007	65		1.587
2008	78		1.482
2009	78		1.494
2010	79		1.509
2011	68		1.433
2012	61		1.463
2013	77		1.493
2014	64		1.508
2015	62		1.492
2016	61		1.470
2017	66		1.481
2018	70		1.476
2019	73		1.463
2020	74		1.442
2021	94	1.477	
2005	Natural Gas	n/a	-
2006		43	1.460
2007		45	1.462

Year	Fuel	% Tier 3	Average Carbon Emission Factor (Tier 3 sites only)
2008		98	1.475
2009		98	1.480
2010		97	1.465
2011		81	1.375
2012		63	1.442
2013		89	1.459
2014		87	1.459
2015		87	1.465
2016		81	1.456
2017		84	1.462
2018		87	1.462
2019		87	1.459
2020		91	1.462
2021		87	1.460

There has been some variation in the proportion of Tier 3 reporting for all three fuels, which will adversely affect the quality of the emission factors, although coverage is still in excess of 50% for all fuels.

Emission factors for **fuel oil** generated from EU/UK ETS data have been adopted in the GHGI, with the exception of data for 2005, where Tier 3 methods were used for only 25% of fuel.

Carbon factors can be derived for **OPG** based on moderate levels of Tier 3 reporting for 2005-2007 and 2011-2019 but 80% for 2008-2010, which gives us a high confidence in the representativeness of the carbon factors for 2008-10. There is some uncertainty regarding the allocation of EU ETS fuels to the OPG fuel category, and the derived emission factors do cover a wider spread of values than for many other fuels in EU ETS. However, this reflects the nature of this fuel, and the data for all years have been used in the inventory.

Carbon factors for natural gas are based on a low % of Tier 3 reporting until 2008; in 2008 to 2010 over 90% of gas use is reported at Tier 3 and over 80% in 2011 and 2013-2019. Within the UK GHGI, the EU ETS factors for 2008 to 2016 are used directly, whilst emission factors for earlier years are derived from gas network operator gas compositional analysis.

EU ETS emission data for **petroleum coke** are higher in 2005-2010, when compared against the estimates derived from DUKES activity data and the industry-recommended emission factor. This is especially noticeable for 2005, where the petroleum coke consumption given in DUKES would have to be more than 100% carbon in order to generate the carbon emissions given in the EU ETS. Consultation with BEIS energy statisticians has identified that the figures given in DUKES are subject to uncertainty and hence the EU ETS data are used directly within the UK GHGI for those years.

**A 7.3.3.3 Integrated Steelworks & Coke Ovens**

**Table A 7.3.5** summarises EU ETS data for the major fuels burnt at integrated steelworks and coke ovens. The data exclude one independent coke oven which calculated emissions using a detailed mass balance approach which makes it more difficult to assess the data in the same way as the other installations. This site closed at the end of 2014.

**Table A 7.3.5 EU/UK ETS data for fuels used at integrated steelworks & coke ovens (Emission Factors in kt/Mt for solid & liquid fuels, kt/Mth for gases)**

Year	Fuel	% Tier 3	Average Carbon Emission Factor (Tier 3 sites only)
2005	Blast furnace gas	0	n/a
2006		100	6.873
2007		90	6.920
2008		92	6.945
2009		92	7.029
2010		100	6.949
2011		94	6.990
2012		96	6.815
2013		91	6.766
2014		91	6.776
2015		100	7.653
2016		100	7.578
2017		90	7.219
2018		100	7.426
2019		100	7.587
2020		96	7.479
2021		100	7.759
2005	Coke oven gas	0	n/a
2006		0	n/a
2007		0	n/a
2008		53	1.093
2009		96	1.140
2010		96	1.117

Year	Fuel	% Tier 3	Average Carbon Emission Factor (Tier 3 sites only)
2011		96	1.089
2012		96	1.094
2013		96	1.103
2014		100	1.143
2015		100	1.216
2016		48	1.659
2017		100	1.068
2018		100	1.133
2019		72	1.094
2020		56	1.055
2021		55	1.548
2005	Natural gas	0	n/a
2006		3	1.479
2007		2	1.478
2008		0	n/a
2009		58	1.425
2010		68	1.441
2011		64	1.441
2012		64	1.443
2013		27	1.447
2014		23	1.445
2015		0	n/a
2016		12	1.445
2017		33	1.446
2018		33	1.456
2019		35	1.436
2020		37	1.432
2021		37	1.443
2005	Fuel oil	0	n/a
2006		0	n/a

Year	Fuel	% Tier 3	Average Carbon Emission Factor (Tier 3 sites only)
2007		0	n/a
2008		84	878
2009		89	885
2010		83	888
2011		88	889
2012		67	877
2013		33	846
2014		30	845
2015		32	845
2016		0	n/a
2017		0	n/a
2018		0	n/a
2019		0	n/a
2020		0	n/a
2021		0	n/a

Most of the ETS data for coke ovens and steelworks are now used in the GHGI, although not the emission factors shown above. Instead, the Inventory Agency have used the EU/UK ETS data and other detailed, site-specific and fuel-specific data, provided by the process operators to refine the carbon balance model used to generate emission estimates for the sector. Details of the revisions to the carbon balance model can be found in the research report from the 2013-2014 inventory improvement programme (Ricardo-AEA, 2014).

#### A 7.3.3.4 Cement Kilns

**Table A 7.3.6** summarises EU/UK ETS data for the major fuels burnt at cement kilns.

**Table A 7.3.6 EU/UK ETS data for Fuels used at Cement Kilns (kt / Mt)**

Year	Fuel	% Tier 3	Average Carbon Emission Factor (Tier 3 sites only)
2005	Coal	8	671.1
2006		100	546.2
2007		100	664.3
2008		100	655.8
2009		99	658.3

Year	Fuel	% Tier 3	Average Carbon Emission Factor (Tier 3 sites only)
2010		100	637.7
2011		100	645.8
2012		100	662.4
2013		100	694.2
2014		100	673.9
2015		100	675.3
2016		98	682.1
2017		100	683.3
2018		100	663.5
2019		100	664.1
2020		92	660.1
2021		100	648.9
2005	Petroleum coke	0	n/a
2006		100	820.8
2007		100	830.2
2008		100	819.1
2009		71	796.8
2010		57	750.8
2011		100	738.4
2012		100	770.2
2013		100	811.1
2014		100	793.4
2015		100	824.6
2016		100	822.2
2017		100	823.1
2018		100	798.1
2019		100	782.0
2020		100	770.5
2021		100	747.9



The EU/UK ETS dataset also provides a detailed breakdown of cement sector process emissions from the decarbonisation of raw materials during the clinker manufacturing process. These data are useful to compare against statistics provided by the Mineral Products Association (MPA) regarding clinker production and the non-combustion emissions associated with UK cement production. The MPA data on clinker production are commercially confidential.

The two data sets show significant differences for 2005-2007; however, the EU ETS data cover only a fraction of the sector, so differences might be expected. From 2008 onwards, there is close agreement (average of 0.5% difference) between the two data sets. The coal IEF data across the time series are also fairly consistent, other than in 2006 where the ETS value is very much lower than in other years. Because of the good agreement in both activity data and emission factors for 2008 onwards, the industry-wide estimates provided by the MPA and used within the GHGI show very close comparison with the EU ETS estimates. The difference between the EU/UK ETS and those reported to the GHGI are consistently less than 1%, as outlined below in **Table A 7.3.7**.

**Table A 7.3.7 Comparison of Cement Sector Carbon Dioxide Emissions\* within the UK GHGI and the EU/UK ETS**

	2008	2010	2015	2017	2018	2019	2020	2021
GHGI CO <sub>2</sub> emissions (kt)	8,288	5,783	6,537	6,555	6,500	6,621	5,804	6,269
Sum of EU/UK ETS CO <sub>2</sub> emissions (kt)	8,250	5,785	6,532	6,549	6,507	6,627	5,817	6,271
EU ETS / GHGI	99.5%	100.0%	99.9%	99.9%	100.1%	100.1%	100.2%	100.0%

\*The data in this table include fuel combustion emissions (reported under IPCC 1A2f) and process emissions (reported under IPCC sector 2A1) from UK cement kilns.

### **A 7.3.3.5 Lime Kilns**

**Table A 7.3.8** summarises data given in the EU ETS datasets for the major fuels burnt at lime kilns. Unlike cement kilns, which often burn a variety of fuels, many lime kilns burn just a single fuel, often natural gas. The data below exclude coke oven coke used in lime kilns at soda ash plant since these kilns were not covered by EU ETS until Phase III, and the small number of sites make the data confidential in any case.

**Table A 7.3.8 EU/UK ETS data for Fuels used at Lime Kilns (Emission Factors in kt / Mt for Solid Fuels and kt / Mth for Gases)**

Year	Fuel	% Tier 3	Average Carbon Emission Factor (Tier 3 sites only)
2005	Coal*	-	N/A
2006		-	N/A
2007		34	846.9
2008		79	701.4
2009		100	698.9
2010		100	634.4
2011		100	703.9
2012		100	725.6
2013		100	689.1
2014		100	680.2
2015		100	693.1
2016		100	688.8
2017		100	677.1
2018		100	683.7
2019		100	655.3
2020		100	684.3
2021	100	652.6	

\*Coal used in the lime industry in the UK includes a proportion of anthracitic coal, and hence some of these IEFs are notably higher than for coal used in other sectors of UK industry.

The EU ETS data for lime kilns vary across the time series, both in terms of the proportion of emissions based on Tier 3 factors, and in the emission factors themselves. EU ETS based factors are currently used for coal and petroleum coke from 2008 onwards, as the EU ETS data do include all lime kilns burning those fuels and almost all those data are Tier 3 and hence are regarded as highly reliable.

EU ETS data for natural gas use in the lime industry does cover all installations burning this fuel, however the proportion of emissions based on Tier 3 factors is very low. Therefore, the EU ETS emission factors are not used in the UK GHGI, and the emission factors for natural gas continue to be based on the methodology given in Baggott *et al*, 2004.

**Table A 7.3.9** shows implied emission factors for process-related emissions from lime kilns that are used within the UK GHG inventory. The lime industry can be sub-divided into those installations where lime is the primary product, and carbon dioxide is an unwanted by-product; and those installations where both lime and carbon dioxide are utilised. The latter include kilns in the sugar industry (where carbon dioxide is used in the purification stages) and soda ash

production (where carbon dioxide is combined with other chemicals to produce sodium carbonate), and in these kilns, the carbon dioxide from decarbonisation of the limestone or dolomite feedstock is assumed to be fully consumed in the process, rather than emitted to atmosphere. **Table A 7.3.9** therefore does not cover these installations. None of the emission factors in EU ETS are Tier 3, so the table shows the overall emission factors for all tiers of data.

**Table A 7.3.9 EU/UK ETS emission factor data for production of lime (kt / Mt lime produced)**

Year	Activity	EU/UK ETS
2005	Lime production	200.4
2006		201.2
2007		201.3
2008		195.6
2009		195.0
2010		194.0
2011		195.6
2012		195.7
2013		194.4
2014		194.6
2015		195.3
2016		196.9
2017		196.0
2018		196.3
2019		195.1
2020		196.5
2021		196.5

These factors compare with a theoretical emission factor based on the stoichiometry of the lime manufacturing process of 214 kt / Mt lime, assuming use of pure limestone. We note that the EU ETS factors are all lower than the theoretical emission factor and this is despite some use of dolomitic limestone in the UK industry which would be expected to further increase the emission factor above the 214 kt/Mt lime factor. The EU/UK ETS data are subject to third party verification, and therefore the emissions data are assumed to be accurate. It is assumed that the reason for this deviation from the theoretical emission factor is due to the production activity data being inflated by either the products containing some proportion of slaked lime (i.e. hydrated product and hence containing a lower proportion of carbon than pure lime) and/or other additives to the lime product which decrease the % carbon content of the lime product.

**A 7.3.3.6 Other Industrial Combustion**

**Table A 7.3.10** summarises EU/UK ETS data for coal, fuel oil and natural gas used by industrial combustion installations.

At first sight, the data for coal looks like it should be reliable enough to be used in the GHGI with 90% or more of emissions based on Tier 3 factors in each year, with the exception of 2010. However, it must be recalled that numerous smaller industrial consumers will not be represented in EU/UK ETS and that the EU/UK ETS data are not fully representative of UK fuels as a whole – see **Section A 7.3** for details. This is also true for ETS data for fuel oil and natural gas but here, in addition, very little of the ETS data are based on Tier 3 factors. Therefore, none of these data have been used directly in the compilation of the GHGI estimates.

**Table A 7.3.10 EU/UK ETS data for Coal, Fuel Oil and Natural Gas used by Industrial Combustion Plant (Emission Factors in kt / Mt for Coal & Fuel Oil, kt / Mth for Natural Gas)**

Year	Fuel	% Tier 3	Average Carbon Emission Factor (Tier 3 sites only)	GHGI Carbon Emission Factor
2005	Coal	98	607.1	647.8
2006		98	603.0	648.6
2007		99	615.7	662.9
2008		94	598.6	656.8
2009		92	595.4	668.8
2010		88	576.5	674.5
2011		91	589.0	653.7
2012		90	599.2	653.9
2013		95	653.4	653.5
2014		98	654.3	651.5
2015		100	645.8	652.4
2016		100	624.9	651.1
2017		100	647.4	651.5
2018		100	653.1	651.5
2019		100	640.7	651.5
2020		100	639.0	651.5
2021	100	642.8	651.5	
2005	Fuel oil	48	864.7	879.0

Year	Fuel	% Tier 3	Average Carbon Emission Factor (Tier 3 sites only)	GHGI Carbon Emission Factor
2006		74	865.3	879.0
2007		50	872.3	879.0
2008		35	871.4	879.0
2009		39	871.3	879.0
2010		40	873.0	879.0
2011		51	874.2	879.0
2012		49	875.1	879.0
2013		44	871.3	879.0
2014		48	875.0	879.0
2015		55	872.1	879.0
2016		63	876.2	879.0
2017		65	880.0	879.0
2018		70	872.3	879.0
2019		88	875.5	879.0
2020		-	-	879.0
2021		-	-	879.0
2005	Natural gas	16	1.593	1.477
2006		37	1.470	1.476
2007		42	1.466	1.476
2008		29	1.496	1.475
2009		43	1.499	1.473
2010		40	1.503	1.472
2011		39	1.466	1.469
2012		40	1.469	1.469
2013		37	1.472	1.473
2014		35	1.474	1.472
2015		34	1.479	1.470
2016		34	1.473	1.463

Year	Fuel	% Tier 3	Average Carbon Emission Factor (Tier 3 sites only)	GHGI Carbon Emission Factor
2017		35	1.485	1.465
2018		33	1.476	1.465
2019		32	1.477	1.460
2020		34	1.473	1.455
2021		32	1.478	1.460

\* No emissions were reported under Tier 3 for this fuel for 2021 in the reported UK ETS data.

Emission factors can also be derived from EU/UK ETS where a high percentage of Tier 3 analysis is evident, for a number of other minor fuels. Due to the very low number of sites that report data for each fuel type, these ETS-derived emission factors are confidential and are not tabulated here. The source/activity combinations for which EU/UK ETS emission factor data are used within the inventory are:

- Other industrial combustion / petroleum coke
- Other industrial combustion / waste solvents
- Other industrial combustion / colliery methane

The ETS-derived emission factors for colliery methane for each year (2005-2021) are also applied to all other sources using these fuels.

## A 7.4 CONSISTENCY OF REPORTED EMISSIONS WITH DATA FROM EMISSIONS TRADING SYSTEM

A comparison has been made between the GHGI emissions data and those of the UK ETS for 2021. The comparison excludes LULUCF and emissions from 1.A.3.a civil aviation. The comparison shows that the UK ETS covers approximately 23% of the total UK GHGI emissions. This translates to 30% for total UK CO<sub>2</sub> emissions.

There are a variety of factors that contribute to such discrepancy between the two datasets that is primarily related to the coverage of data in the UK ETS. In the energy industries category (1.A.1), the UK ETS excludes public electricity and heat generation (1.A.1.a) using Municipal Solid Waste (MSW). The UK ETS dataset does not cover all the emissions from the manufacture of solid fuels and other energy industries (1.A.1.c). There are also differences between the allocation of emissions and scope of the ETS and GHGI for iron and steel sector that may contribute to the differences.

Another source of discrepancy arises from the emissions associated with the manufacturing industries and construction (1.A.2). The allocation of emissions to the ETS does not necessarily match those of the GHGI for the iron and steel sector (1.A.2.a). Almost all of the non-ferrous metals sector in the UK are small and therefore not covered by the ETS. The same issue also

applies to the food sector (1.A.2.e). Furthermore, the GHG inventory figures do exclude emissions as the result of autogeneration (reported instead in 1.A.2.g).

Most UK sites in the other industry sector (1.A.2.g) are small and excluded from the ETS. The GHG inventory figures also include fuels used throughout industry for autogeneration, whereas in the ETS these emissions will be split between 1.A.2.c, 1.A.2.d, 1.A.2.e and 1.A.2.g. Finally, GHG inventory figures include certain minor fuels burnt at cement and lime kilns which will be included in 1.A.2.f. in the ETS data.

With regards to fugitive emissions from fuels (1.B), the allocation of emissions in UK ETS to 1.A.1.c, 1.B, 1.A.2 and 2.C.1 is not exactly comparable to GHG inventory. The high percentage of emissions under the ETS reflects the high proportion of upstream oil and gas flaring emissions that make up the UK GHGI, since all UK offshore rigs and oil and gas terminals are covered by UK ETS.

With regards to nitrous oxide (N<sub>2</sub>O) emissions from nitric acid production (2.B.2) activities, figures for the installations in the UK ETS dataset do not seem to match the N<sub>2</sub>O emissions reported by the operators directly to both the Inventory Agency, and to the regulator for inclusion in the Pollution Inventory (covering emissions from industrial sites subject to EPR 2012 in England) and PRTR. Within the UK ETS reporting, it is not always clear which emissions are of N<sub>2</sub>O and which are of CO<sub>2</sub> from combustion of off-gases. It is therefore likely that the ETS figures include emissions of CO<sub>2</sub> that would be reported in the GHG inventory under 2.B.1. We note that the overall GHGI figures for 2.B.1 (CO<sub>2</sub>) and 2.B.2 (N<sub>2</sub>O) slightly exceed those in the UK ETS, and so we believe that the GHG inventory figures are accurate or even conservative.

For the full analysis, please see the '*Consistency of reported GHG emissions\_2023.xlsx*' supplemental Excel file.

## **ANNEX 8: UK Domestic Emissions Reporting Requirements**

In addition to the reporting requirements of the UNFCCC, UK Greenhouse Gas Inventory statistics are published annually in a Department for Energy Security and Net Zero National Statistics release<sup>42</sup>. The geographical coverage of these estimates differs from the UNFCCC, with the totals mainly covering emissions from the UK only (i.e. excluding overseas territories and crown dependencies).

The UK has domestic targets for reducing greenhouse gas emissions under the Climate Change Act 2008 (CCA)<sup>43</sup>. The CCA established a long-term legally binding framework to reduce emissions, initially committing the UK to reducing emissions by at least 80% below 1990 emissions by 2050. In June 2019, following the IPCC's Special Report on Global Warming of 1.5°C and advice from the independent Climate Change Committee, the CCA was amended to commit the UK to achieving a 100% reduction in emissions (to net zero) by 2050.

The CCA also introduced carbon budgets, which set legally binding limits on the total amount of greenhouse gas emissions the UK can emit for a given five-year period. The UK has met its first and second carbon budgets covering the periods 2008-2012 and 2013-2017 respectively.

Summary tables of the National Statistics release data are presented below. The data are presented in the nine categories used in UK Official Statistics (National Communication Categories).

---

<sup>42</sup> <https://www.gov.uk/government/collections/final-uk-greenhouse-gas-emissions-national-statistics>

<sup>43</sup> <https://www.legislation.gov.uk/ukpga/2008/27/contents>



**A 8.1 NATIONAL STATISTICS****Table A 8.1.1 Summary table of GHG emissions by NC Category, including net emissions/removals from LULUCF (Mt CO<sub>2</sub>eq) - National Statistics coverage (UK only)**

NC category	1990	1995	2000	2005	2010	2015	2018	2019	2020	2021
Energy supply	283.5	240.5	224.7	232.6	208.4	145.9	104.6	96.2	84.5	86.9
Business	111.9	109.9	112.9	104.7	88.6	81.3	78.3	77.0	73.9	75.3
Transport	128.6	130.1	133.2	136.0	125.0	123.9	125.0	123.1	99.3	109.5
Public	16.0	15.7	13.8	12.2	9.5	8.0	7.8	7.7	7.2	7.5
Residential	80.3	81.6	88.6	85.5	87.3	67.1	68.3	65.5	65.2	69.4
Agriculture	54.4	53.6	52.3	51.0	48.4	49.2	48.3	48.1	46.6	47.9
Industrial processes	55.4	47.0	26.4	20.6	12.7	12.7	10.3	10.5	9.5	10.3
LULUCF <sup>44</sup>	11.1	8.8	6.3	3.4	1.5	1.0	1.4	1.7	1.2	1.1
Waste management	72.1	75.2	67.7	52.8	31.5	21.2	20.8	20.6	19.0	18.7
Total	813.4	762.3	725.8	698.7	613.0	510.4	464.8	450.4	406.3	426.5

**Table A 8.1.2 Summary table of GHG emissions by Gas, including net emissions/removals from LULUCF (Mt CO<sub>2</sub>eq) - National Statistics coverage (UK only)**

Gas	1990	1995	2000	2005	2010	2015	2018	2019	2020	2021
CO <sub>2</sub>	604.0	565.7	566.0	564.8	505.0	414.4	371.6	358.2	318.5	339.5
CH <sub>4</sub>	150.3	143.6	123.8	100.8	75.2	62.5	60.4	60.0	57.5	57.0
N <sub>2</sub> O	44.3	35.5	26.7	23.1	20.6	19.9	19.7	19.8	18.6	19.1
HFCs	12.1	15.6	6.9	8.6	11.2	12.9	12.4	11.8	11.0	10.3
PFCs	1.5	0.5	0.5	0.4	0.3	0.3	0.1	0.2	0.2	0.2
SF <sub>6</sub>	1.2	1.3	1.9	1.1	0.7	0.4	0.6	0.5	0.4	0.4
NF <sub>3</sub>	0.0	0.0	0.0	0.0	0.0	0.0	0.0	0.0	0.0	0.0
Total	813.4	762.3	725.8	698.7	613.0	510.4	464.8	450.4	406.3	426.5

<sup>44</sup> Land use, land use change and forestry

---

## ANNEX 9: End User Emissions

### A 9.1 INTRODUCTION

This Annex explains the concept of an end user emissions (sometimes also referred to as “final user emissions”, summarises the end user calculation methodology with examples, and contains tables of greenhouse gas emissions according to the end user from 1990 to 2021.

The end user sectoral categories used are consistent with those used in the National Communications (NC) to the UNFCCC. The sectoral categories in the NC are derived from the UNFCCC reporting guidelines on national communications<sup>45</sup>.

The purpose of the end user calculations is to allocate emissions from fuel and electricity producers to the energy users - this allows the emission estimates for a consumer of energy to include the emissions from the production of the fuel or electricity they use.

The UNFCCC does not require end user data to be included in the UK’s National Inventory Report. These data have been included to provide DESNZ with information for their policy support needs.

The tables in this Annex present summary data for UK greenhouse gas emissions for the years 1990-2021, inclusive. These data are updated annually to reflect revisions in the methods used to estimate emissions, and the availability of new information within the inventory. These recalculations are applied retrospectively to earlier years to ensure a consistent time series and this accounts for any differences in data published in previous reports.

Emissions presented in this chapter show emissions from the UK only, consistent with the BEIS UK statistical release.

### A 9.2 DEFINITION OF END USERS

The end user<sup>46</sup> calculations allocate emissions from fuel producers to fuel users. The end user calculation therefore allows estimates to be made of emissions for a consumer of fuel, which also include the emissions from producing the fuel the consumer has used.

The emissions included in the end user categories can be illustrated with an example of two end users - the residential sector and road transport:

- Emissions in the **residential** end user category include:
  1. All direct emissions from domestic premises, for example, from burning gas, coal or oil for space heating.

---

<sup>45</sup> See page 84 of UNFCCC Guidelines contained in FCCC/CP/1999/7 available at: <http://unfccc.int/resource/docs/cop5/07.pdf>

<sup>46</sup> An end user is a consumer of fuel for useful energy. A ‘fuel producer’ is someone who extracts, processes or converts fuels for the end use of end users. Clearly there can be some overlap of these categories but here the fuel uses categories of the UK BEIS publication DUKES are used, which enable a distinction to be made.

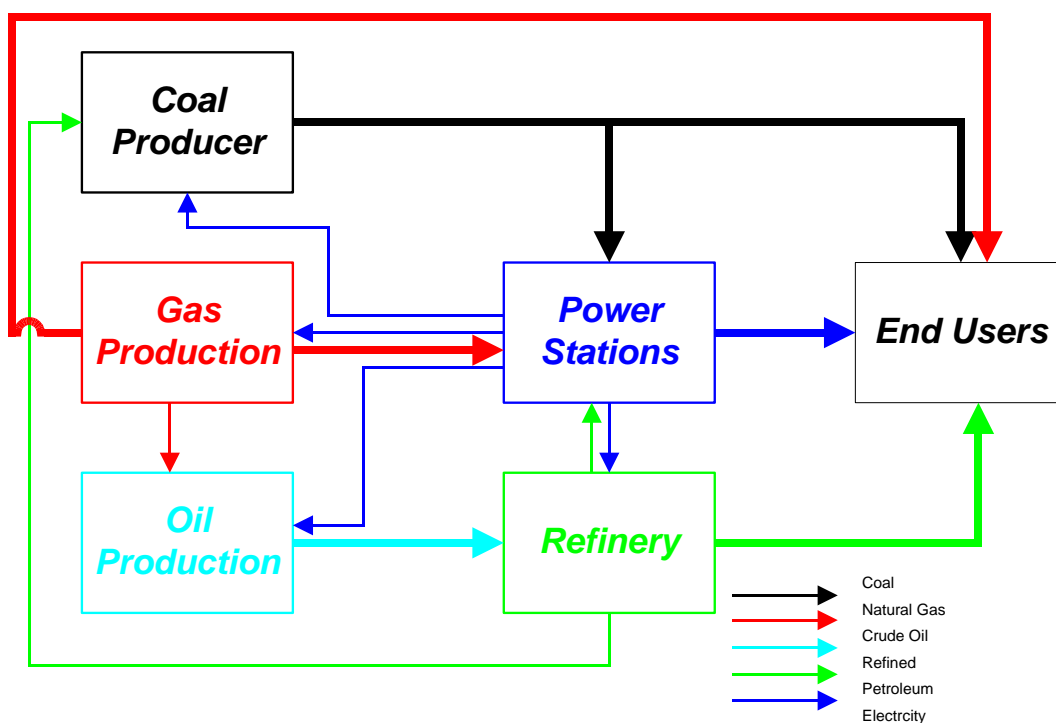
- 2. A portion of indirect emissions used by domestic consumers from: power stations generating electricity; emissions from refineries including refining, storage, flaring and extraction; emissions from coal mines (including emissions due to fuel use in the mining industry itself and fugitive emissions of methane from the mines); and emissions from the extraction, storage and distribution of mains gas.
- Emissions in the **road transport** end user category include:
  - 1. Direct emissions from motor vehicle exhausts.
  - 2. A portion of indirect emissions from: refineries producing motor fuels, including refining, storage, flaring and extraction of oil; the distribution and supply of motor fuels; and power stations generating the electricity used by electric vehicles.

### A 9.3 OVERVIEW OF THE END USER CALCULATIONS

Fuel and electricity producers also require the use of energy which comes from other producers. Therefore, in the process of reallocating emissions to the end user, emissions are allocated from one to the other and then are reallocated to end users. This circularity results in an iterative approach being used to estimate emissions from categories of end users.

**Figure A 9.1** shows a simplified view of the energy flows in the UK (the fuels used in the greenhouse gas inventory have hundreds of uses). This figure shows that while end users consuming electricity are responsible for a proportion of the emissions from power stations they are also responsible for emissions from collieries, and some of these emissions in turn come from electricity generated in power stations and from refineries.

**Figure A 9.1** Simplified fuel flows for an end user calculation.



The approach for estimating end user emissions is summarised in the three steps below:

1. Emissions are calculated for each sector for each fuel.
2. Emissions from fuel and electricity producers are then distributed to those sectors that use the fuel according to the energy content<sup>47</sup> of the fuel they use (these sectors can include other fuel producers). This distribution is based on inventory fuel consumption data and DUKES electricity consumption data.
3. By this stage in the calculation, emissions from end users will have increased and those from fuel and electricity producers will have decreased. The sum of emissions from fuel producers and power stations in a particular year as a percentage of the total emissions is then calculated. If this percentage, for any year, exceeds a predetermined value (In the model used to determine emissions from end users, the value of this percentage can be adjusted. The tables presented later in this Annex were calculated for a convergence at 0.001%) the process continues at Step 2. If this percentage matches or is less than the predetermined value, the calculation is finished.

Convergence occurs as the fuel flows to the end users are much greater than fuel flows amongst the fuel producers.

While a direct solution could possibly be used it was decided to base the calculation on an iterative approach because:

- This can be implemented in the database structures already in existence for the UK greenhouse gas inventory;
- It can handle a wide range of flows and loops that occur without any of the limits that other approaches may incur; and
- The same code will cover all likely situations and will be driven by tabular data stored in the database.

## A 9.4 EXAMPLE END USER CALCULATION

The following example illustrates the methodology used to calculate emissions according to end users. The units in this example are arbitrary.

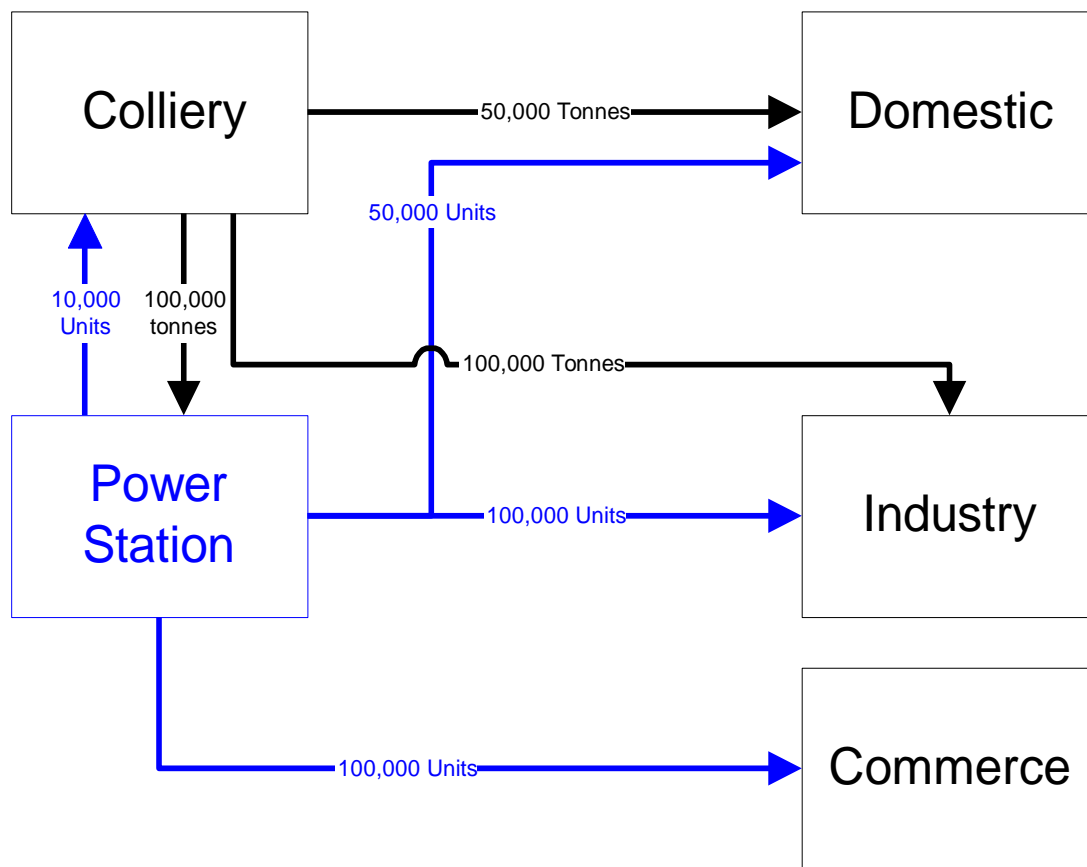
The example in **Figure A 9.2** has two fuel producers, *power stations* and *collieries*, and three end users, *residential*, *industry* and *commercial*. The following assumptions have been made for simplicity:

- The only fuels used are coal and electricity;
- Coal is the only source of carbon emissions (released from burning coal in power stations to produce electricity and from burning coal in the home for space heating); and
- Commerce uses no coal and so has zero 'direct' emissions.

---

<sup>47</sup> If calorific data for the fuels is not available then the mass of fuel is used instead. This is the case for years prior to 1990.

**Figure A 9.2 Fuel use in the example calculation**



In **Figure A 9.2**, the tonnes refer to tonnes of coal burnt (black arrows), and the units refer to units of electricity consumed (blue arrows).

In this example the coal extracted by the colliery is burnt in the power station to produce electricity for the end users. Industrial and residential users also directly burn coal. Although the colliery uses electricity produced by the power station, it is not considered to be an end user. The colliery is a ‘fuel producer’ as it is part of the chain that extracts, processes and converts fuels for the end users.

**Table A 9.4.1** summarises the outputs during this example end user calculation.

**Table A 9.4.1 Example of the outputs during an end user calculation**

		Sector					Unallocated emissions as percentage of total emission	Total emission of carbon (tonnes)	
		Colliery	Power Station	Residential	Industrial	Commercial			
Coal use (tonnes)	Mass	100	100,000	50,000	100,000	0			
	Energy content	25,000	25,000,000	12,500,000	25,000,000	0			
Electricity use (arbitrary units)	Energy units	10,000		50,000	100,000	100,000			
Emissions of carbon (tonnes)	Initial	70	70,000	35,000	70,000	0	40.02	175,070	
	Emissions after iteration step	1	2,692	28	48,476	96,951	26,923	1.55	175,070
		2	1	1077	49,020	98,039	26,934	0.62	175,070
		3	41	1	49,227	98,454	27,348	0.02	175,070
		4	0	17	49,235	98,470	27,348	0.01	175,070
		5	1	0	49,238	98,477	27,355	0	175,070
		6	0	0	49,239	98,477	27,355	0	175,070

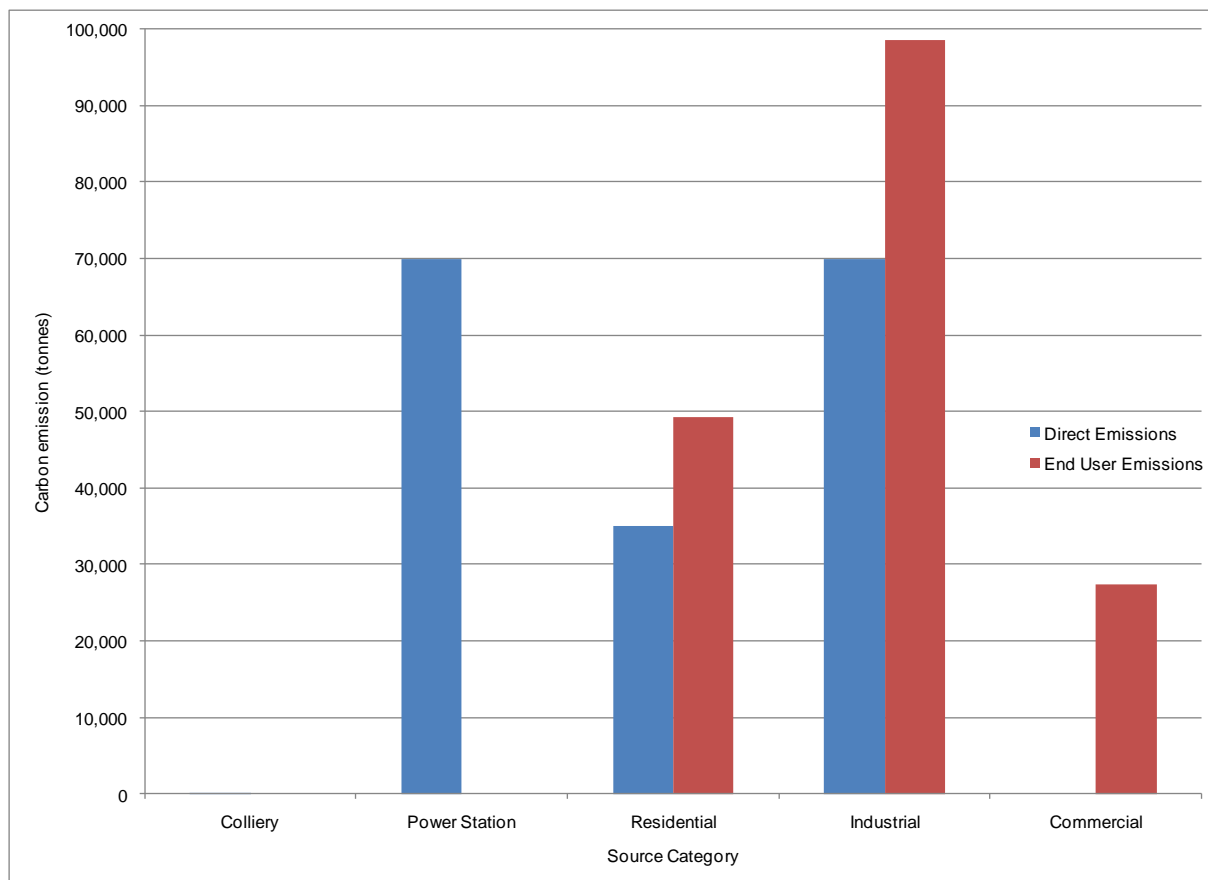
The initial carbon emissions are 70% of the mass of coal burnt. The emissions from the power stations are distributed to the other sectors by using the factor:

- $(\text{Electricity used by that sector}) / (\text{total electricity used minus own use by power stations})$ ;
- Similarly, for the colliery emissions the following factor is used; and
- $(\text{Energy of coal used by that sector}) / (\text{total energy of coal consumed used minus own use by collieries})$ .

At the end of iteration step one, the commerce sector has 26,923 tonnes of carbon emissions allocated to it, mainly derived from power stations. Emissions allocated to the residential and industry sectors have also increased over their initial allocations. However, collieries and power stations still have some emissions allocated to them (these come from each other) and so the reallocation process is repeated to reduce these allocations to zero – these two sectors are not end users. The total unallocated (in this example, equal to the total emissions from collieries and power stations) falls in each iteration until the emissions are consistently allocated across the sectors. In this example, six iterations are needed to achieve a consistent allocation across the sectors.

The sum of emissions allocated to the sectors (175,070 tonnes of carbon) remains unchanged from the initial allocation to the allocation in the sixth iteration. This check is an important quality control measure to ensure all emissions are accounted for during the end user calculations.

**Figure A 9.3 Comparison of ‘direct’ and end user emissions of carbon according to the sectors considered in the end user example**



**Figure A 9.3** compares the quantities of direct and end user carbon emitted from each sector at the end of the end user calculation. The direct emissions of carbon are from the combustion of coal in the sectors. The direct and end user emissions are from two distinct calculations and must be considered independently – in other words, the direct and end user emissions in each sector must not be summed. The sum of all the direct emissions and the sum of the end user emissions, are identical.

There are relatively large direct emissions of carbon from power stations, residential and industry sectors. The end user emissions from the power stations and the colliery are zero because these two sectors are not end users. The carbon emissions from these two sectors have been reallocated to the residential, industrial and commercial sectors. This reallocation means the end user emissions for the residential and industrial sectors are greater than their ‘direct’ emissions.

## **A 9.5 END USER CALCULATION METHODOLOGY FOR THE UK GREENHOUSE GAS INVENTORY**

The approach divides fuel user emissions into 8 categories (see column 1 of **Table A 9.5.1**). For each of these groups, source categories are distributed by the total energy consumption of a group of fuels. For example, for the coal group, the emissions of four source categories are distributed to end users according to the energy use of anthracite and coal combined.

**Table A 9.5.1 Sources reallocated to end users and the fuels used**

End user group	Emission sources to be reallocated to end users	Fuels used for redistribution
1. Coke	Coke production	Coke
	Iron and steel – flaring	Blast furnace gas
2. Coal	Closed Coal Mines	Coal
	Coal storage and transport	Anthracite
	Collieries – combustion	
	Deep-mined coal	
	Open-cast coal	
3. Natural gas	Gas leakage	Natural gas
	Gas production	
	Upstream Gas Production - flaring	
	Upstream Gas Production - fuel combustion	
	Upstream Gas Production - Gas terminal storage	
	Upstream Gas Production - Offshore Well Testing	
	Upstream Gas Production - venting	
	Upstream oil and gas production - combustion at gas separation plant	
	Upstream Gas Production - fugitive emissions	
	Gas Terminal: Other Fugitives	
	Gas Terminal: Gas Flaring	
	Well exploration (unconventional gas): all sources	
	Gas terminal: fuel combustion	
	Gas Terminal: Direct Process	
	Gas Terminal: Venting	
	Onshore natural gas production (conventional)	
	Onshore natural gas gathering	
	Upstream Gas Production: direct process emissions	
4. Electricity	Autogeneration - exported to grid	Electricity



End user group	Emission sources to be reallocated to end users	Fuels used for redistribution
	Nuclear fuel production	
	Power stations	
	Power stations - FGD	
5. Petroleum	Petroleum processes	Aviation spirit
	Refineries - combustion	Aviation turbine fuel
	Upstream Oil Production - flaring	Biodiesel
	Upstream Oil Production - fuel combustion	Bioethanol
	Upstream Oil Production - Offshore Oil Loading	Burning oil
	Upstream Oil Production - Offshore Well Testing	Burning oil (premium)
	Upstream Oil Production - Oil terminal storage	DERV
	Upstream Oil Production - Onshore Oil Loading	Fuel oil
	Upstream Oil Production - venting	Gas oil
	Oil transport fugitives: pipelines (to shore)	Lubricants
	Oil transport fugitives: pipelines (onshore)	LNG
	Oil transport fugitives: road tankers	LPG
	Onshore oil production (conventional)	Naphtha
	Upstream Oil Production: direct process emissions	OPG
	Onshore oil well exploration (conventional)	Petrol
	Upstream Oil Production - fugitive emissions	Petroleum coke
	Oil terminal: fuel combustion	Refinery miscellaneous
	Oil Terminal: Gas Flaring	Vaporising oil
	Oil Terminal: Other Fugitives	
	Oil Terminal: Direct Process	
	Abandoned oil wells (onshore)	
	Onshore oil production: gas flaring	
	Abandoned oil wells (offshore)	
	Oil Terminal: Venting	

End user group	Emission sources to be reallocated to end users	Fuels used for redistribution
6. Solid Smokeless Fuels	Solid Smokeless fuel production	Solid Smokeless Fuels
7. Town gas	Town gas manufacture	Town Gas
8. Charcoal	Charcoal production	Charcoal

Comments on the calculation methodology used to allocate emissions according to the end users are listed below:

- Emissions are allocated to end users on the basis of the proportion of the total energy produced that is used by a given sector. This approach is followed to allow for sectors such as petroleum where different products are made in a refinery;
- Some emissions are allocated to an “exports” category. This is for emissions within the UK from producing fuels, (for example from a refinery or coal mine), which are subsequently exported or sent to bunkers for use outside the UK. Therefore, these emissions are part of the UK inventory even if the use of the fuel produces emissions that cannot be included in the UK inventory because it takes place outside the UK;
- No allowance is made for the emission from the production of fuels or electricity outside the UK that are subsequently imported;
- Some of the output of a refinery is not used as a fuel but used as feedstock or lubricants. This is not currently treated separately and the emissions from their production (which are small) are allocated to users of petroleum fuels. This is partly due to lack of data in the database used to calculate the inventory, and partly due to the lack of a clear, transparent way of separating emissions from the production of fuels and from the production of non-fuel petroleum products; and
- End user emissions are estimated for aviation in four categories: domestic take-off and landing, international take-off and landing, domestic cruise and international cruise. This enables both IPCC and UNECE categories to be estimated from the same end user calculation.

Our exact mapping of end user emissions to IPCC categories is shown in **Table A 9.5.2**. The NAEI source sectors and activity names are also shown, as it is necessary to subdivide some IPCC categories. This classification has been used to generate the end user tables for the greenhouse gases given in this section. As this table is for end users, no fuel producers are included in the table.

**Table A 9.5.2 End user category, IPCC sectors, and NAEI source names and activity names used in the emission calculation**

National Communication Sector	IPCC Category	Source	ActivityName
Agriculture	1A4ci_Agriculture/Forestry/Fishing:Stationary	Agriculture - stationary combustion	Biogas Biomass Burning oil Coal Fuel oil Gas oil Natural gas Straw
	1A4cii_Agriculture/Forestry/Fishing:Off-road	Agriculture - mobile machinery	Gas oil
	2D1_Lubricant_Use	Agricultural engines	Lubricants
	3A1a_Enterice_Fermentation_dairy_cattle	Enteric	Dairy - Dairy Cows
	3A1b_Enterice_Fermentation_non-dairy_cattle	Enteric	Other cattle - Beef females for slaughter Other cattle - Bulls for breeding Other cattle - Cereal fed bull  Other cattle - Cows Other cattle - Dairy Calves Female Other cattle - Dairy In Calf Heifers Other cattle - Dairy Replacements Female Other cattle - Heifers for breeding Other cattle - Steers
	3A2_Enterice_Fermentation_sheep	Enteric	Sheep - Ewe

National Communication Sector	IPCC Category	Source	ActivityName
			Sheep - Lamb Sheep - Ram
	3A3_Enterice_Fermentation_swine	Enteric	Pig - Boar Pig - Fattening Pig < 20 kg Pig - Fattening Pig > 80 kg Pig - Fattening Pig 20 to 80 kg Pig - Gilt Pig - Sow
	3A4_Enterice_Fermentation_other:deer	Enteric	Deer
	3A4_Enterice_Fermentation_other:goats	Enteric	Goats
	3A4_Enterice_Fermentation_other:horses	Enteric	Agricultural Horses Domestic Horses Professional Horses
	3B11a_Manure_Management_Methane_dairy_cattle	Digestate	Dairy - Dairy Cows
		Excreta	Dairy - Dairy Cows
		Managed Manure	Dairy - Dairy Cows
	3B11b_Manure_Management_Methane_non-dairy_cattle	Digestate	Other cattle - Beef females for slaughter Other cattle - Bulls for breeding Other cattle - Cereal fed bull  Other cattle - Cows Other cattle - Dairy Calves Female Other cattle - Dairy In Calf Heifers

National Communication Sector	IPCC Category	Source	ActivityName
			Other cattle - Dairy Replacements Female Other cattle - Heifers for breeding Other cattle - Steers
		Excreta	Other cattle - Beef females for slaughter Other cattle - Bulls for breeding Other cattle - Cereal fed bull Other cattle - Cows Other cattle - Dairy Calves Female Other cattle - Dairy In Calf Heifers Other cattle - Dairy Replacements Female Other cattle - Heifers for breeding Other cattle - Steers
		Managed Manure	Other cattle - Beef females for slaughter Other cattle - Bulls for breeding Other cattle - Cereal fed bull Other cattle - Cows Other cattle - Dairy Calves Female Other cattle - Dairy In Calf Heifers Other cattle - Dairy Replacements Female

National Communication Sector	IPCC Category	Source	ActivityName
			Other cattle - Heifers for breeding
			Other cattle - Steers
	3B12_Manure_Management_Methane_sheep	Excreta	Sheep - Ewe Sheep - Lamb Sheep - Ram
		Managed Manure	Sheep - Ewe Sheep - Lamb Sheep - Ram
	3B13_Manure_Management_Methane_swine	Digestate	Pig - Boar Pig - Fattening Pig < 20 kg Pig - Fattening Pig > 80 kg Pig - Fattening Pig 20 to 80 kg Pig - Gilt Pig - Sow
		Excreta	Pig - Boar Pig - Fattening Pig < 20 kg Pig - Fattening Pig > 80 kg Pig - Fattening Pig 20 to 80 kg Pig - Gilt Pig - Sow
		Managed Manure	Pig - Boar Pig - Fattening Pig < 20 kg

National Communication Sector	IPCC Category	Source	ActivityName
			Pig - Fattening Pig > 80 kg Pig - Fattening Pig 20 to 80 kg Pig - Gilt Pig - Sow
	3B14_Manure_Management_Methane_other:deer	Excreta	Deer
		Managed Manure	Deer
	3B14_Manure_Management_Methane_other:goats	Excreta	Goats
		Managed Manure	Goats
	3B14_Manure_Management_Methane_other:horses	Excreta	Agricultural Horses Domestic Horses Professional Horses
		Managed Manure	Agricultural Horses Domestic Horses Professional Horses
	3B14_Manure_Management_Methane_other:poultry	Digestate	Poultry - Breeding Flock Poultry - Broilers Poultry - Ducks Poultry - Geese Poultry - Growing Pullets Poultry - Laying Hens Poultry - Other Poultry - Turkeys
		Excreta	Poultry - Breeding Flock

National Communication Sector	IPCC Category	Source	ActivityName
			Poultry - Broilers Poultry - Ducks Poultry - Geese Poultry - Growing Pullets Poultry - Laying Hens Poultry - Other Poultry - Turkeys
		Managed Manure	Poultry - Breeding Flock Poultry - Broilers Poultry - Ducks Poultry - Geese Poultry - Growing Pullets Poultry - Laying Hens Poultry - Other Poultry - Turkeys
	3B21a_Manure_Management_Non-methane_dairy_cattle	Dairy - Dairy Cows - Direct	Housing
	3B21b_Manure_Management_Non-methane_non-dairy_cattle	Other cattle - Beef females for slaughter - Direct	Housing
		Other cattle - Bulls for breeding - Direct	Housing
		Other cattle - Cereal fed bull - Direct	Housing
		Other cattle - Cows - Direct	Housing
		Other cattle - Dairy Calves Female - Direct	Housing
		Other cattle - Dairy In Calf Heifers - Direct	Housing



National Communication Sector	IPCC Category	Source	ActivityName
		Other cattle - Dairy Replacements Female - Direct	Housing
		Other cattle - Heifers for breeding - Direct	Housing
		Other cattle - Steers - Direct	Housing
	3B22_Manure_Management_Non-methane_sheep	Sheep - Ewe - Direct	Storage
		Sheep - Lamb - Direct	Storage
		Sheep - Ram - Direct	Storage
	3B23_Manure_Management_Non-methane_swine	Pig - Boar - Direct	Housing
		Pig - Fattening Pig < 20 kg - Direct	Housing
		Pig - Fattening Pig > 80 kg - Direct	Housing
		Pig - Fattening Pig 20 to 80 kg - Direct	Housing
		Pig - Gilt - Direct	Housing
		Pig - Sow - Direct	Housing
	3B24_Manure_Management_Non-methane_other:Deer	Deer - Direct	Housing
	3B24_Manure_Management_Non-methane_other:Goats	Goats - Direct	Housing
	3B24_Manure_Management_Non-methane_other:horses	Agricultural Horses - Direct	Housing
		Domestic Horses - Direct	Housing
		Professional Horses - Direct	Housing
	3B24_Manure_Management_Non-methane_other:poultry	Poultry - Breeding Flock - Direct	Housing
		Poultry - Broilers - Direct	Housing
		Poultry - Ducks - Direct	Housing
		Poultry - Geese - Direct	Housing
Poultry - Growing Pullets - Direct		Housing	
Poultry - Laying Hens - Direct		Housing	
Poultry - Other - Direct		Housing	

National Communication Sector	IPCC Category	Source	ActivityName
		Poultry - Turkeys - Direct	Housing
	3B25_Manure_Management_Indirect_Emissions_dairy_cattle	Dairy - Dairy Cows - Digestate Indirect Deposition	Storage
		Dairy - Dairy Cows - Indirect Deposition	Housing Storage Yarding
		Dairy - Dairy Cows - Indirect Leach	Storage
	3B25_Manure_Management_Indirect_Emissions_other:deer	Deer - Indirect Deposition	Housing Storage
		Deer - Indirect Leach	Storage
	3B25_Manure_Management_Indirect_Emissions_other:goats	Goats - Indirect Deposition	Housing Storage
		Goats - Indirect Leach	Storage
	3B25_Manure_Management_Indirect_Emissions_other:horses	Agricultural Horses - Indirect Deposition	Housing Storage
		Agricultural Horses - Indirect Leach	Storage
		Domestic Horses - Indirect Deposition	Housing Storage
		Domestic Horses - Indirect Leach	Storage
		Professional Horses - Indirect Deposition	Housing Storage
		Professional Horses - Indirect Leach	Storage
	3B25_Manure_Management_Indirect_Emissions_other:poultry	Poultry - Breeding Flock - Digestate Indirect Deposition	Storage

National Communication Sector	IPCC Category	Source	ActivityName
		Poultry - Breeding Flock - Indirect Deposition	Housing Storage
		Poultry - Breeding Flock - Indirect Leach	Storage
		Poultry - Broilers - Digestate Indirect Deposition	Storage
		Poultry - Broilers - Indirect Deposition	Housing Storage
		Poultry - Broilers - Indirect Leach	Storage
		Poultry - Ducks - Digestate Indirect Deposition	Storage
		Poultry - Ducks - Indirect Deposition	Housing Storage
		Poultry - Ducks - Indirect Leach	Storage
		Poultry - Geese - Digestate Indirect Deposition	Storage
		Poultry - Geese - Indirect Deposition	Housing Storage
		Poultry - Geese - Indirect Leach	Storage
		Poultry - Growing Pullets - Digestate Indirect Deposition	Storage
		Poultry - Growing Pullets - Indirect Deposition	Housing Storage
		Poultry - Growing Pullets - Indirect Leach	Storage
		Poultry - Laying Hens - Digestate Indirect Deposition	Storage
		Poultry - Laying Hens - Indirect Deposition	Housing

National Communication Sector	IPCC Category	Source	ActivityName
			Storage
		Poultry - Laying Hens - Indirect Leach	Storage
		Poultry - Other - Digestate Indirect Deposition	Storage
		Poultry - Other - Indirect Deposition	Housing Storage
		Poultry - Other - Indirect Leach	Storage
		Poultry - Turkeys - Digestate Indirect Deposition	Storage
		Poultry - Turkeys - Indirect Deposition	Housing Storage
		Poultry - Turkeys - Indirect Leach	Storage
		3B25_Manure_Management_Indirect_Emissions_other_cattle	Other cattle - Beef females for slaughter - Digestate Indirect Deposition
	Other cattle - Beef females for slaughter - Indirect Deposition		Housing Storage Yarding
	Other cattle - Beef females for slaughter - Indirect Leach		Storage
	Other cattle - Bulls for breeding - Digestate Indirect Deposition		Storage
	Other cattle - Bulls for breeding - Indirect Deposition		Housing Storage Yarding
	Other cattle - Bulls for breeding - Indirect Leach		Storage
	Other cattle - Cereal fed bull - Digestate Indirect Deposition		Storage

National Communication Sector	IPCC Category	Source	ActivityName
		Other cattle - Cereal fed bull - Indirect Deposition	Housing Storage Yarding
		Other cattle - Cereal fed bull - Indirect Leach	Storage
		Other cattle - Cows - Digestate Indirect Deposition	Storage
		Other cattle - Cows - Indirect Deposition	Housing Storage Yarding
		Other cattle - Cows - Indirect Leach	Storage
		Other cattle - Dairy Calves Female - Digestate Indirect Deposition	Storage
		Other cattle - Dairy Calves Female - Indirect Deposition	Housing Storage Yarding
		Other cattle - Dairy Calves Female - Indirect Leach	Storage
		Other cattle - Dairy In Calf Heifers - Digestate Indirect Deposition	Storage
		Other cattle - Dairy In Calf Heifers - Indirect Deposition	Housing Storage Yarding
		Other cattle - Dairy In Calf Heifers - Indirect Leach	Storage
		Other cattle - Dairy Replacements Female - Digestate Indirect Deposition	Storage

National Communication Sector	IPCC Category	Source	ActivityName	
		Other cattle - Dairy Replacements Female - Indirect Deposition	Housing Storage Yarding	
		Other cattle - Dairy Replacements Female - Indirect Leach	Storage	
		Other cattle - Heifers for breeding - Digestate Indirect Deposition	Storage	
		Other cattle - Heifers for breeding - Indirect Deposition	Housing Storage Yarding	
		Other cattle - Heifers for breeding - Indirect Leach	Storage	
		Other cattle - Steers - Digestate Indirect Deposition	Storage	
		Other cattle - Steers - Indirect Deposition	Housing Storage Yarding	
		Other cattle - Steers - Indirect Leach	Storage	
		3B25_Manure_Management_Indirect_Emissions_sheep	Sheep - Ewe - Indirect Deposition	Housing Storage
			Sheep - Ewe - Indirect Leach	Storage
			Sheep - Lamb - Indirect Deposition	Housing Storage
			Sheep - Lamb - Indirect Leach	Storage
			Sheep - Ram - Indirect Deposition	Housing Storage

National Communication Sector	IPCC Category	Source	ActivityName
		Sheep - Ram - Indirect Leach	Storage
	3B25_Manure_Management_Indirect_Emissions_swine	Pig - Boar - Digestate Indirect Deposition	Storage
		Pig - Boar - Indirect Deposition	Housing Storage
		Pig - Boar - Indirect Leach	Storage
		Pig - Fattening Pig < 20 kg - Digestate Indirect Deposition	Storage
		Pig - Fattening Pig < 20 kg - Indirect Deposition	Housing Storage
		Pig - Fattening Pig < 20 kg - Indirect Leach	Storage
		Pig - Fattening Pig > 80 kg - Digestate Indirect Deposition	Storage
		Pig - Fattening Pig > 80 kg - Indirect Deposition	Housing Storage
		Pig - Fattening Pig > 80 kg - Indirect Leach	Storage
		Pig - Fattening Pig 20 to 80 kg - Digestate Indirect Deposition	Storage
		Pig - Fattening Pig 20 to 80 kg - Indirect Deposition	Housing Storage
		Pig - Fattening Pig 20 to 80 kg - Indirect Leach	Storage
		Pig - Gilt - Digestate Indirect Deposition	Storage
		Pig - Gilt - Indirect Deposition	Housing Storage
		Pig - Gilt - Indirect Leach	Storage

National Communication Sector	IPCC Category	Source	ActivityName	
		Pig - Sow - Digestate Indirect Deposition	Storage	
		Pig - Sow - Indirect Deposition	Housing Storage	
		Pig - Sow - Indirect Leach	Storage	
	3D11_Agricultural_Soils_Inorganic_N_Fertilisers		Arable - Direct	Ammonium Nitrate Application Ammonium Sulphate and Diammonium Phosphate Application Calcium Ammonium Nitrate Application Other Nitrogen Including Compounds Application Urea Ammonium Nitrate Application Urea Application
			Grass - Direct	Ammonium Nitrate Application Ammonium Sulphate and Diammonium Phosphate Application Calcium Ammonium Nitrate Application Other Nitrogen Including Compounds Application Urea Ammonium Nitrate Application Urea Application
	3D12a_Agricultural_Soils_Manure_Applied_to_Soils		Agricultural Horses - Direct	Spreading
			Dairy - Dairy Cows - Direct	Spreading



National Communication Sector	IPCC Category	Source	ActivityName
		Deer - Direct	Spreading
		Domestic Horses - Direct	Spreading
		Goats - Direct	Spreading
		Other cattle - Beef females for slaughter - Direct	Spreading
		Other cattle - Bulls for breeding - Direct	Spreading
		Other cattle - Cereal fed bull - Direct	Spreading
		Other cattle - Cows - Direct	Spreading
		Other cattle - Dairy Calves Female - Direct	Spreading
		Other cattle - Dairy In Calf Heifers - Direct	Spreading
		Other cattle - Dairy Replacements Female - Direct	Spreading
		Other cattle - Heifers for breeding - Direct	Spreading
		Other cattle - Steers - Direct	Spreading
		Pig - Boar - Direct	Spreading
		Pig - Fattening Pig < 20 kg - Direct	Spreading
		Pig - Fattening Pig > 80 kg - Direct	Spreading
		Pig - Fattening Pig 20 to 80 kg - Direct	Spreading
		Pig - Gilt - Direct	Spreading
		Pig - Sow - Direct	Spreading
		Poultry - Breeding Flock - Direct	Spreading
		Poultry - Broilers - Direct	Spreading
		Poultry - Ducks - Direct	Spreading
		Poultry - Geese - Direct	Spreading

National Communication Sector	IPCC Category	Source	ActivityName
		Poultry - Growing Pullets - Direct	Spreading
		Poultry - Laying Hens - Direct	Spreading
		Poultry - Other - Direct	Spreading
		Poultry - Turkeys - Direct	Spreading
		Professional Horses - Direct	Spreading
		Sheep - Ewe - Direct	Spreading
		Sheep - Lamb - Direct	Spreading
		Sheep - Ram - Direct	Spreading
	3D12b_Agricultural_Soils_Sewage_Sludge_Applied_to_Soils	Sewage Sludge Cake - Direct	Spreading
		Sewage Sludge Liquid - Direct	Spreading
	3D12c_Agricultural_Soils_Other_Organic_Fertilisers_Applied_to_Soils	Beef females for slaughter - Digestate Direct	Spreading
		Boar - Digestate Direct	Spreading
		Broilers - Digestate Direct	Spreading
		Bulls for breeding - Digestate Direct	Spreading
		Cereal fed bull - Digestate Direct	Spreading
		Cows - Digestate Direct	Spreading
		Crop Digestates - Direct	Spreading
		Dairy Calves Female - Digestate Direct	Spreading
		Dairy Cows - Digestate Direct	Spreading
		Dairy In Calf Heifers - Digestate Direct	Spreading
		Dairy Replacements Female - Digestate Direct	Spreading
Fattening Pig < 20 kg - Digestate Direct		Spreading	
Fattening Pig > 80 kg - Digestate Direct		Spreading	

National Communication Sector	IPCC Category	Source	ActivityName
		Fattening Pig 20 to 80 kg - Digestate Direct	Spreading
		Food Digestates - Direct	Spreading
		Gilt - Digestate Direct	Spreading
		Heifers for breeding - Digestate Direct	Spreading
		Laying Hens - Digestate Direct	Spreading
		Other organic residue Digestates - Direct	Spreading
		Poultry - Breeding Flock - Digestate Direct	Spreading
		Poultry - Ducks - Digestate Direct	Spreading
		Poultry - Geese - Digestate Direct	Spreading
		Poultry - Growing Pullets - Digestate Direct	Spreading
		Poultry - Other - Digestate Direct	Spreading
		Sow - Digestate Direct	Spreading
		Steers - Digestate Direct	Spreading
		Turkeys - Digestate Direct	Spreading
		3D13_Agricultural_Soils_Manure_Deposited_by_Grazing_Animals	Agricultural Horses - Direct
	Dairy - Dairy Cows - Direct	Grazing	
	Deer - Direct	Grazing	
	Domestic Horses - Direct	Grazing	
	Goats - Direct	Grazing	
	Other cattle - Beef females for slaughter - Direct	Grazing	
	Other cattle - Bulls for breeding - Direct	Grazing	
	Other cattle - Cereal fed bull - Direct	Grazing	

National Communication Sector	IPCC Category	Source	ActivityName
		Other cattle - Cows - Direct	Grazing
		Other cattle - Dairy Calves Female - Direct	Grazing
		Other cattle - Dairy In Calf Heifers - Direct	Grazing
		Other cattle - Dairy Replacements Female - Direct	Grazing
		Other cattle - Heifers for breeding - Direct	Grazing
		Other cattle - Steers - Direct	Grazing
		Pig - Boar - Direct	Grazing
		Pig - Fattening Pig < 20 kg - Direct	Grazing
		Pig - Fattening Pig > 80 kg - Direct	Grazing
		Pig - Fattening Pig 20 to 80 kg - Direct	Grazing
		Pig - Gilt - Direct	Grazing
		Pig - Sow - Direct	Grazing
		Poultry - Breeding Flock - Direct	Grazing
		Poultry - Broilers - Direct	Grazing
		Poultry - Ducks - Direct	Grazing
		Poultry - Geese - Direct	Grazing
		Poultry - Growing Pullets - Direct	Grazing
		Poultry - Laying Hens - Direct	Grazing
		Poultry - Other - Direct	Grazing
		Poultry - Turkeys - Direct	Grazing
		Professional Horses - Direct	Grazing
		Sheep - Ewe - Direct	Grazing
		Sheep - Lamb - Direct	Grazing

National Communication Sector	IPCC Category	Source	ActivityName
		Sheep - Ram - Direct	Grazing
	3D14_Agricultural_Soils_Residues	Arable - Direct	Ammonium Nitrate Residue Ammonium Sulphate and Diammonium Phosphate Residue Calcium Ammonium Nitrate Residue No Nitrogen Fertiliser Applied Residue Other Nitrogen Including Compounds Residue Urea Ammonium Nitrate Residue Urea Residue
		Grass - Direct	Ammonium Nitrate Residue Ammonium Sulphate and Diammonium Phosphate Residue Calcium Ammonium Nitrate Residue No Nitrogen Fertiliser Applied Residue Other Nitrogen Including Compounds Residue Urea Ammonium Nitrate Residue Urea Residue
	3D15_Agricultural_soils_Mineralization/Immobilization	Cropland management	Mineralisation
	3D16_Agricultural_soils_Cultivation_of_Organic_Soils	Managed Histosols	Land area

National Communication Sector	IPCC Category	Source	ActivityName
	3D21_Agricultural_Soils_Indirect_Deposition	Agricultural Horses - Indirect Deposition	Grazing Spreading
Arable - Indirect Deposition		Ammonium Nitrate Application Ammonium Sulphate and Diammonium Phosphate Application Calcium Ammonium Nitrate Application Other Nitrogen Including Compounds Application Urea Ammonium Nitrate Application Urea Application	
Crop Digestates - Indirect Deposition		Spreading	
Dairy - Dairy Cows - Digestate Indirect Deposition		Spreading	
Dairy - Dairy Cows - Indirect Deposition		Grazing Spreading	
Deer - Indirect Deposition		Grazing Spreading	
Domestic Horses - Indirect Deposition		Grazing Spreading	
Food Digestates - Indirect Deposition		Spreading	
Goats - Indirect Deposition		Grazing Spreading	
Grass - Indirect Deposition		Ammonium Nitrate Application	

National Communication Sector	IPCC Category	Source	ActivityName
			Ammonium Sulphate and Diammonium Phosphate Application Calcium Ammonium Nitrate Application Other Nitrogen Including Compounds Application Urea Ammonium Nitrate Application Urea Application
		Other cattle - Beef females for slaughter - Digestate Indirect Deposition	Spreading
		Other cattle - Beef females for slaughter - Indirect Deposition	Grazing Spreading
		Other cattle - Bulls for breeding - Digestate Indirect Deposition	Spreading
		Other cattle - Bulls for breeding - Indirect Deposition	Grazing Spreading
		Other cattle - Cereal fed bull - Digestate Indirect Deposition	Spreading
		Other cattle - Cereal fed bull - Indirect Deposition	Grazing Spreading
		Other cattle - Cows - Digestate Indirect Deposition	Spreading
		Other cattle - Cows - Indirect Deposition	Grazing Spreading
		Other cattle - Dairy Calves Female - Digestate Indirect Deposition	Spreading

National Communication Sector	IPCC Category	Source	ActivityName
		Other cattle - Dairy Calves Female - Indirect Deposition	Grazing Spreading
		Other cattle - Dairy In Calf Heifers - Digestate Indirect Deposition	Spreading
		Other cattle - Dairy In Calf Heifers - Indirect Deposition	Grazing Spreading
		Other cattle - Dairy Replacements Female - Digestate Indirect Deposition	Spreading
		Other cattle - Dairy Replacements Female - Indirect Deposition	Grazing Spreading
		Other cattle - Heifers for breeding - Digestate Indirect Deposition	Spreading
		Other cattle - Heifers for breeding - Indirect Deposition	Grazing Spreading
		Other cattle - Steers - Digestate Indirect Deposition	Spreading
		Other cattle - Steers - Indirect Deposition	Grazing Spreading
		Other organic residue Digestates - Indirect Deposition	Spreading
		Pig - Boar - Digestate Indirect Deposition	Spreading
		Pig - Boar - Indirect Deposition	Grazing Spreading
		Pig - Fattening Pig < 20 kg - Digestate Indirect Deposition	Spreading



National Communication Sector	IPCC Category	Source	ActivityName
		Pig - Fattening Pig < 20 kg - Indirect Deposition	Grazing Spreading
		Pig - Fattening Pig > 80 kg - Digestate Indirect Deposition	Spreading
		Pig - Fattening Pig > 80 kg - Indirect Deposition	Grazing Spreading
		Pig - Fattening Pig 20 to 80 kg - Digestate Indirect Deposition	Spreading
		Pig - Fattening Pig 20 to 80 kg - Indirect Deposition	Grazing Spreading
		Pig - Gilt - Digestate Indirect Deposition	Spreading
		Pig - Gilt - Indirect Deposition	Grazing Spreading
		Pig - Sow - Digestate Indirect Deposition	Spreading
		Pig - Sow - Indirect Deposition	Grazing Spreading
		Poultry - Breeding Flock - Digestate Indirect Deposition	Spreading
		Poultry - Breeding Flock - Indirect Deposition	Grazing Spreading
		Poultry - Broilers - Digestate Indirect Deposition	Spreading
		Poultry - Broilers - Indirect Deposition	Grazing Spreading
		Poultry - Ducks - Digestate Indirect Deposition	Spreading

National Communication Sector	IPCC Category	Source	ActivityName
		Poultry - Ducks - Indirect Deposition	Grazing Spreading
		Poultry - Geese - Digestate Indirect Deposition	Spreading
		Poultry - Geese - Indirect Deposition	Grazing Spreading
		Poultry - Growing Pullets - Digestate Indirect Deposition	Spreading
		Poultry - Growing Pullets - Indirect Deposition	Grazing Spreading
		Poultry - Laying Hens - Digestate Indirect Deposition	Spreading
		Poultry - Laying Hens - Indirect Deposition	Grazing Spreading
		Poultry - Other - Digestate Indirect Deposition	Spreading
		Poultry - Other - Indirect Deposition	Grazing Spreading
		Poultry - Turkeys - Digestate Indirect Deposition	Spreading
		Poultry - Turkeys - Indirect Deposition	Grazing Spreading
		Professional Horses - Indirect Deposition	Grazing Spreading
		Sewage Sludge Cake - Indirect Deposition	Spreading
		Sewage Sludge Liquid - Indirect Deposition	Spreading

National Communication Sector	IPCC Category	Source	ActivityName
		Sheep - Ewe - Indirect Deposition	Grazing Spreading
		Sheep - Lamb - Indirect Deposition	Grazing Spreading
		Sheep - Ram - Indirect Deposition	Grazing Spreading
	3D22_Agricultural_Soils_Indirect_Leaching_and_Run-off	Agricultural Horses - Indirect Leach	Grazing Spreading
		Arable - Indirect Leach	Ammonium Nitrate Application Ammonium Sulphate and Diammonium Phosphate Application Calcium Ammonium Nitrate Application Other Nitrogen Including Compounds Application Urea Ammonium Nitrate Application Urea Application
		Arable - Residue Indirect Leach	Ammonium Nitrate Application Ammonium Sulphate and Diammonium Phosphate Application Calcium Ammonium Nitrate Application No Nitrogen Fertiliser Applied Other Nitrogen Including Compounds Application

National Communication Sector	IPCC Category	Source	ActivityName
			Urea Ammonium Nitrate Application Urea Application
		Crop Digestates - Indirect Leach	Spreading
		Cropland management	Mineralisation - indirect leach
		Dairy - Dairy Cows - Digestate Indirect Leach	Spreading
		Dairy - Dairy Cows - Indirect Leach	Grazing Spreading
		Deer - Indirect Leach	Grazing Spreading
		Domestic Horses - Indirect Leach	Grazing Spreading
		Food Digestates - Indirect Leach	Spreading
		Goats - Indirect Leach	Grazing Spreading
		Grass - Indirect Leach	Ammonium Nitrate Application Ammonium Sulphate and Diammonium Phosphate Application Calcium Ammonium Nitrate Application Other Nitrogen Including Compounds Application Urea Ammonium Nitrate Application Urea Application

National Communication Sector	IPCC Category	Source	ActivityName
		Grass - Residue Indirect Leach	Ammonium Nitrate Application Ammonium Sulphate and Diammonium Phosphate Application Calcium Ammonium Nitrate Application No Nitrogen Fertiliser Applied Other Nitrogen Including Compounds Application Urea Ammonium Nitrate Application Urea Application
		Other cattle - Beef females for slaughter - Digestate Indirect Leach	Spreading
		Other cattle - Beef females for slaughter - Indirect Leach	Grazing Spreading
		Other cattle - Bulls for breeding - Digestate Indirect Leach	Spreading
		Other cattle - Bulls for breeding - Indirect Leach	Grazing Spreading
		Other cattle - Cereal fed bull - Digestate Indirect Leach	Spreading
		Other cattle - Cereal fed bull - Indirect Leach	Grazing Spreading
		Other cattle - Cows - Digestate Indirect Leach	Spreading
		Other cattle - Cows - Indirect Leach	Grazing Spreading

National Communication Sector	IPCC Category	Source	ActivityName
		Other cattle - Dairy Calves Female - Digestate Indirect Leach	Spreading
		Other cattle - Dairy Calves Female - Indirect Leach	Grazing Spreading
		Other cattle - Dairy In Calf Heifers - Digestate Indirect Leach	Spreading
		Other cattle - Dairy In Calf Heifers - Indirect Leach	Grazing Spreading
		Other cattle - Dairy Replacements Female - Digestate Indirect Leach	Spreading
		Other cattle - Dairy Replacements Female - Indirect Leach	Grazing Spreading
		Other cattle - Heifers for breeding - Digestate Indirect Leach	Spreading
		Other cattle - Heifers for breeding - Indirect Leach	Grazing Spreading
		Other cattle - Steers - Digestate Indirect Leach	Spreading
		Other cattle - Steers - Indirect Leach	Grazing Spreading
		Other organic residue Digestates - Indirect Leach	Spreading
		Pig - Boar - Digestate Indirect Leach	Spreading
		Pig - Boar - Indirect Leach	Grazing Spreading
		Pig - Fattening Pig < 20 kg - Digestate Indirect Leach	Spreading

National Communication Sector	IPCC Category	Source	ActivityName
		Pig - Fattening Pig < 20 kg - Indirect Leach	Grazing Spreading
		Pig - Fattening Pig > 80 kg - Digestate Indirect Leach	Spreading
		Pig - Fattening Pig > 80 kg - Indirect Leach	Grazing Spreading
		Pig - Fattening Pig 20 to 80 kg - Digestate Indirect Leach	Spreading
		Pig - Fattening Pig 20 to 80 kg - Indirect Leach	Grazing Spreading
		Pig - Gilt - Digestate Indirect Leach	Spreading
		Pig - Gilt - Indirect Leach	Grazing Spreading
		Pig - Sow - Digestate Indirect Leach	Spreading
		Pig - Sow - Indirect Leach	Grazing Spreading
		Poultry - Breeding Flock - Digestate Indirect Leach	Spreading
		Poultry - Breeding Flock - Indirect Leach	Grazing Spreading
		Poultry - Broilers - Digestate Indirect Leach	Spreading
		Poultry - Broilers - Indirect Leach	Grazing Spreading
		Poultry - Ducks - Digestate Indirect Leach	Spreading

National Communication Sector	IPCC Category	Source	ActivityName
		Poultry - Ducks - Indirect Leach	Grazing Spreading
		Poultry - Geese - Digestate Indirect Leach	Spreading
		Poultry - Geese - Indirect Leach	Grazing Spreading
		Poultry - Growing Pullets - Digestate Indirect Leach	Spreading
		Poultry - Growing Pullets - Indirect Leach	Grazing Spreading
		Poultry - Laying Hens - Digestate Indirect Leach	Spreading
		Poultry - Laying Hens - Indirect Leach	Grazing Spreading
		Poultry - Other - Digestate Indirect Leach	Spreading
		Poultry - Other - Indirect Leach	Grazing Spreading
		Poultry - Turkeys - Digestate Indirect Leach	Spreading
		Poultry - Turkeys - Indirect Leach	Grazing Spreading
		Professional Horses - Indirect Leach	Grazing Spreading
		Sewage Sludge Cake - Indirect Leach	Spreading
		Sewage Sludge Liquid - Indirect Leach	Spreading
		Sheep - Ewe - Indirect Leach	Grazing



National Communication Sector	IPCC Category	Source	ActivityName
			Spreading
		Sheep - Lamb - Indirect Leach	Grazing Spreading
		Sheep - Ram - Indirect Leach	Grazing Spreading
	3F11_Field_burning_wheat	Field burning	Wheat residue
	3F12_Field_burning_barley	Field burning	Barley residue
	3F14_Field_burning_other_cereals	Field burning	Oats residue
	3F5_Field_burning_other_residues	Field burning	Linseed residue
	3G1_Liming - limestone	Liming	Limestone
	3G2_Liming - dolomite	Liming	Dolomite
	3H_Urea application	Fertiliser Application	Urea Application
	non-IPCC	Agriculture - stationary combustion	Electricity
Business	1A2a_Iron_and_steel	Iron and steel - combustion plant	Coal
			Coke
			Fuel oil
			Gas oil
			LPG
		Natural gas	
	1A2b_Non-Ferrous_Metals	Autogeneration - exported to grid	Coal
		Autogenerators	Coal
		Non-Ferrous Metal (combustion)	Coal
			Fuel oil
			Gas oil
			Natural gas

National Communication Sector	IPCC Category	Source	ActivityName
	1A2c_Chemicals	Chemicals (combustion)	Biogas Biomass Coal Fuel oil Gas oil Natural gas
	1A2d_Pulp_Paper_Print	Pulp, Paper and Print (combustion)	Biogas Biomass Coal Fuel oil Gas oil Natural gas
	1A2e_food_processing_beverages_and_tobacco	Food & drink, tobacco (combustion)	Biogas Biomass Coal Fuel oil Gas oil Natural gas
	1A2f_Non-metallic_minerals	Cement production - combustion	Coal Fuel oil Gas oil Natural gas Petroleum coke Scrap tyres Waste

National Communication Sector	IPCC Category	Source	ActivityName
			Waste oils Waste solvent
		Lime production - non decarbonising	Coal Coke Natural gas
		Other industrial combustion	Scrap tyres
	1A2gvii_Off-road_vehicles_and_other_machinery	Industrial off-road mobile machinery	Gas oil Petrol
	1A2gviii_Other_manufacturing_industries_and_construction	Autogeneration - exported to grid	Natural gas
		Autogenerators	Biogas Natural gas
		Other industrial combustion	Biogas Biomass Burning oil Coal Coke Coke oven gas Colliery methane Fuel oil Gas oil LPG Lubricants Natural gas OPG Petroleum coke

National Communication Sector	IPCC Category	Source	ActivityName
			SSF Waste solvent Wood
	1A4ai_Commercial/Institutional	Miscellaneous industrial/commercial combustion	Coal Fuel oil Gas oil MSW Natural gas
	1A4aii_Commercial/Institutional_Mobile	Industrial off-road mobile machinery	LPG
	2B1_Chemical_Industry:Ammonia_production	Ammonia production - combustion	Natural gas
	2B8a_Methanol_production	Methanol production – combustion	Natural gas
	2B8g_Petrochemical_and_carbon_black_production:Other	Chemicals (combustion)	OPG
	2C1b_Pig_iron	Blast furnaces	Blast furnace gas Coal Coke oven gas LPG Natural gas
		Iron and steel - combustion plant	Blast furnace gas Coke oven gas
	2D1_Lubricant_Use	Industrial engines	Lubricants
	2D3_Other_NEU	Non Energy Use: petroleum coke	Petroleum coke
	2E1_Integrated_circuit_or_semiconductor	Electronics - HFC	Non-fuel combustion
		Electronics - NF <sub>3</sub>	Non-fuel combustion
	2F1a_Commercial_refrigeration	Commercial Refrigeration: Commercial central systems, chill	Halocarbon bank: HFC-125

National Communication Sector	IPCC Category	Source	ActivityName
			Halocarbon bank: HFC-134a Halocarbon bank: HFC-143a Halocarbon bank: HFC-152a Halocarbon bank: HFC-32 Halocarbon in products at disposal: HFC-125 Halocarbon in products at disposal: HFC-134a Halocarbon in products at disposal: HFC-143a Halocarbon in products at disposal: HFC-152a Halocarbon in products at disposal: HFC-32 Halocarbon used for manufacturing: HFC-125 Halocarbon used for manufacturing: HFC-134a Halocarbon used for manufacturing: HFC-143a Halocarbon used for manufacturing: HFC-32
		Commercial Refrigeration: Commercial central systems, frozen	Halocarbon bank: HFC-125 Halocarbon bank: HFC-134a Halocarbon bank: HFC-143a

National Communication Sector	IPCC Category	Source	ActivityName
			Halocarbon bank: HFC-32 Halocarbon in products at disposal: HFC-125 Halocarbon in products at disposal: HFC-134a Halocarbon in products at disposal: HFC-143a Halocarbon in products at disposal: HFC-32 Halocarbon used for manufacturing: HFC-125 Halocarbon used for manufacturing: HFC-134a Halocarbon used for manufacturing: HFC-143a Halocarbon used for manufacturing: HFC-32
		Commercial Refrigeration: Commercial condensing units, chill	Halocarbon bank: HFC-125 Halocarbon bank: HFC-134a Halocarbon bank: HFC-143a Halocarbon bank: HFC-152a Halocarbon bank: HFC-32 Halocarbon in products at disposal: HFC-125 Halocarbon in products at disposal: HFC-134a

National Communication Sector	IPCC Category	Source	ActivityName
			Halocarbon in products at disposal: HFC-143a Halocarbon in products at disposal: HFC-152a Halocarbon used for manufacturing: HFC-125 Halocarbon used for manufacturing: HFC-134a Halocarbon used for manufacturing: HFC-143a Halocarbon used for manufacturing: HFC-32
		Commercial Refrigeration: Commercial condensing units, frozen	Halocarbon bank: HFC-125 Halocarbon bank: HFC-134a Halocarbon bank: HFC-143a Halocarbon bank: HFC-32 Halocarbon in products at disposal: HFC-125 Halocarbon in products at disposal: HFC-134a Halocarbon in products at disposal: HFC-143a Halocarbon used for manufacturing: HFC-125 Halocarbon used for manufacturing: HFC-134a

National Communication Sector	IPCC Category	Source	ActivityName
			Halocarbon used for manufacturing: HFC-143a Halocarbon used for manufacturing: HFC-32
		Commercial Refrigeration: Commercial integral systems, chill	Halocarbon bank: HFC-125 Halocarbon bank: HFC-134a Halocarbon bank: HFC-143a Halocarbon bank: HFC-32 Halocarbon in products at disposal: HFC-125 Halocarbon in products at disposal: HFC-134a Halocarbon in products at disposal: HFC-143a Halocarbon used for manufacturing: HFC-125 Halocarbon used for manufacturing: HFC-134a Halocarbon used for manufacturing: HFC-143a Halocarbon used for manufacturing: HFC-32
		Commercial Refrigeration: Commercial integral systems, frozen	Halocarbon bank: HFC-125 Halocarbon bank: HFC-134a



National Communication Sector	IPCC Category	Source	ActivityName
			Halocarbon bank: HFC-143a Halocarbon bank: HFC-32 Halocarbon in products at disposal: HFC-125 Halocarbon in products at disposal: HFC-134a Halocarbon in products at disposal: HFC-143a Halocarbon used for manufacturing: HFC-125 Halocarbon used for manufacturing: HFC-134a Halocarbon used for manufacturing: HFC-143a Halocarbon used for manufacturing: HFC-32
	2F1b_Domestic_refrigeration	Domestic Refrigeration: Domestic freezers	Halocarbon bank: HFC-134a Halocarbon in products at disposal: HFC-134a
		Domestic Refrigeration: Domestic refrigerators and freezers	Halocarbon bank: HFC-134a Halocarbon in products at disposal: HFC-134a
	2F1c_Industrial_refrigeration	Industrial Refrigeration: Industrial chillers, large	Halocarbon bank: HFC-125 Halocarbon bank: HFC-134a Halocarbon bank: HFC-152a

National Communication Sector	IPCC Category	Source	ActivityName
			Halocarbon in products at disposal: HFC-125 Halocarbon in products at disposal: HFC-134a Halocarbon in products at disposal: HFC-152a Halocarbon used for manufacturing: HFC-134a
		Industrial Refrigeration: Industrial chillers, mid-size	Halocarbon bank: HFC-125 Halocarbon bank: HFC-134a Halocarbon bank: HFC-152a Halocarbon bank: HFC-32 Halocarbon in products at disposal: HFC-125 Halocarbon in products at disposal: HFC-134a Halocarbon in products at disposal: HFC-152a Halocarbon in products at disposal: HFC-32 Halocarbon used for manufacturing: HFC-125 Halocarbon used for manufacturing: HFC-134a Halocarbon used for manufacturing: HFC-32
		Industrial Refrigeration: Industrial DX systems, large, chill	Halocarbon bank: HFC-125

National Communication Sector	IPCC Category	Source	ActivityName
			Halocarbon bank: HFC-134a Halocarbon bank: HFC-143a Halocarbon bank: HFC-152a Halocarbon bank: HFC-32 Halocarbon in products at disposal: HFC-125 Halocarbon in products at disposal: HFC-134a Halocarbon in products at disposal: HFC-143a Halocarbon in products at disposal: HFC-152a Halocarbon used for manufacturing: HFC-125 Halocarbon used for manufacturing: HFC-134a Halocarbon used for manufacturing: HFC-143a Halocarbon used for manufacturing: HFC-32
		Industrial Refrigeration: Industrial DX systems, large, frozen	Halocarbon bank: HFC-125 Halocarbon bank: HFC-134a Halocarbon bank: HFC-143a Halocarbon bank: HFC-32

National Communication Sector	IPCC Category	Source	ActivityName
			Halocarbon in products at disposal: HFC-125 Halocarbon in products at disposal: HFC-134a Halocarbon in products at disposal: HFC-143a Halocarbon used for manufacturing: HFC-125 Halocarbon used for manufacturing: HFC-134a Halocarbon used for manufacturing: HFC-143a Halocarbon used for manufacturing: HFC-32
		Industrial Refrigeration: Industrial DX systems, mid-size, chill	Halocarbon bank: HFC-125 Halocarbon bank: HFC-134a Halocarbon bank: HFC-143a Halocarbon bank: HFC-152a Halocarbon bank: HFC-32 Halocarbon in products at disposal: HFC-125 Halocarbon in products at disposal: HFC-134a Halocarbon in products at disposal: HFC-143a Halocarbon in products at disposal: HFC-152a

National Communication Sector	IPCC Category	Source	ActivityName
			Halocarbon used for manufacturing: HFC-125 Halocarbon used for manufacturing: HFC-134a Halocarbon used for manufacturing: HFC-143a Halocarbon used for manufacturing: HFC-32
		Industrial Refrigeration: Industrial DX systems, mid-size, frozen	Halocarbon bank: HFC-125 Halocarbon bank: HFC-134a Halocarbon bank: HFC-143a Halocarbon bank: HFC-32 Halocarbon in products at disposal: HFC-125 Halocarbon in products at disposal: HFC-134a Halocarbon in products at disposal: HFC-143a Halocarbon used for manufacturing: HFC-125 Halocarbon used for manufacturing: HFC-134a Halocarbon used for manufacturing: HFC-143a

National Communication Sector	IPCC Category	Source	ActivityName
			Halocarbon used for manufacturing: HFC-32
		Industrial Refrigeration: Industrial DX systems, small, chill	Halocarbon bank: HFC-125 Halocarbon bank: HFC-134a Halocarbon bank: HFC-143a Halocarbon bank: HFC-152a Halocarbon bank: HFC-32 Halocarbon in products at disposal: HFC-125 Halocarbon in products at disposal: HFC-134a Halocarbon in products at disposal: HFC-143a Halocarbon in products at disposal: HFC-152a Halocarbon used for manufacturing: HFC-125 Halocarbon used for manufacturing: HFC-134a Halocarbon used for manufacturing: HFC-143a Halocarbon used for manufacturing: HFC-32
		Industrial Refrigeration: Industrial DX systems, small, frozen	Halocarbon bank: HFC-125 Halocarbon bank: HFC-134a

National Communication Sector	IPCC Category	Source	ActivityName
			Halocarbon bank: HFC-143a Halocarbon bank: HFC-32 Halocarbon in products at disposal: HFC-125 Halocarbon in products at disposal: HFC-134a Halocarbon in products at disposal: HFC-143a Halocarbon used for manufacturing: HFC-125 Halocarbon used for manufacturing: HFC-134a Halocarbon used for manufacturing: HFC-143a Halocarbon used for manufacturing: HFC-32
		Industrial Refrigeration: Industrial flooded systems, large, chill	Halocarbon bank: HFC-125 Halocarbon bank: HFC-134a Halocarbon bank: HFC-152a Halocarbon in products at disposal: HFC-125 Halocarbon in products at disposal: HFC-134a Halocarbon in products at disposal: HFC-152a Halocarbon used for manufacturing: HFC-134a

National Communication Sector	IPCC Category	Source	ActivityName
	2F1d_Transport_refrigeration	Transport Refrigeration: Systems for large trucks, iso-containers	Halocarbon bank: HFC-125 Halocarbon bank: HFC-134a Halocarbon bank: HFC-143a Halocarbon bank: HFC-32 Halocarbon in products at disposal: HFC-125 Halocarbon in products at disposal: HFC-134a Halocarbon in products at disposal: HFC-143a Halocarbon used for manufacturing: HFC-125 Halocarbon used for manufacturing: HFC-134a Halocarbon used for manufacturing: HFC-143a Halocarbon used for manufacturing: HFC-32
		Transport Refrigeration: Systems for marine vessels	Halocarbon bank: HFC-125 Halocarbon bank: HFC-134a Halocarbon bank: HFC-143a Halocarbon bank: HFC-152a Halocarbon bank: HFC-32



National Communication Sector	IPCC Category	Source	ActivityName
			Halocarbon in products at disposal: HFC-125 Halocarbon in products at disposal: HFC-134a Halocarbon in products at disposal: HFC-143a Halocarbon in products at disposal: HFC-152a Halocarbon used for manufacturing: HFC-125 Halocarbon used for manufacturing: HFC-134a Halocarbon used for manufacturing: HFC-143a
		Transport Refrigeration: Systems for vans, light trucks	Halocarbon bank: HFC-125 Halocarbon bank: HFC-134a Halocarbon bank: HFC-143a Halocarbon bank: HFC-32 Halocarbon in products at disposal: HFC-125 Halocarbon in products at disposal: HFC-134a Halocarbon in products at disposal: HFC-143a Halocarbon used for manufacturing: HFC-125 Halocarbon used for manufacturing: HFC-134a

National Communication Sector	IPCC Category	Source	ActivityName
			Halocarbon used for manufacturing: HFC-143a Halocarbon used for manufacturing: HFC-32
	2F1e_Mobile_air_conditioning	Mobile Air-Conditioning: MAC systems - buses, trains	Halocarbon bank: HFC-125 Halocarbon bank: HFC-134a Halocarbon bank: HFC-227ea Halocarbon bank: HFC-32 Halocarbon in products at disposal: HFC-125 Halocarbon in products at disposal: HFC-134a Halocarbon in products at disposal: HFC-32 Halocarbon used for manufacturing: HFC-125 Halocarbon used for manufacturing: HFC-134a Halocarbon used for manufacturing: HFC-227ea Halocarbon used for manufacturing: HFC-32
		Mobile Air-Conditioning: MAC systems - cars, vans, cabs	Halocarbon bank: HFC-134a Halocarbon in products at disposal: HFC-134a

National Communication Sector	IPCC Category	Source	ActivityName
			Halocarbon used for manufacturing: HFC-134a
	2F1f_Stationary_air_conditioning	Stationary Air-Conditioning: AC chillers, large	Halocarbon bank: HFC-134a Halocarbon in products at disposal: HFC-134a Halocarbon used for manufacturing: HFC-134a
		Stationary Air-Conditioning: AC chillers, mid-size	Halocarbon bank: HFC-125 Halocarbon bank: HFC-134a Halocarbon bank: HFC-152a Halocarbon bank: HFC-32 Halocarbon in products at disposal: HFC-125 Halocarbon in products at disposal: HFC-134a Halocarbon in products at disposal: HFC-152a Halocarbon in products at disposal: HFC-32 Halocarbon used for manufacturing: HFC-125 Halocarbon used for manufacturing: HFC-134a Halocarbon used for manufacturing: HFC-32
		Stationary Air-Conditioning: AC chillers, small	Halocarbon bank: HFC-125

National Communication Sector	IPCC Category	Source	ActivityName
			Halocarbon bank: HFC-134a Halocarbon bank: HFC-152a Halocarbon bank: HFC-32 Halocarbon in products at disposal: HFC-125 Halocarbon in products at disposal: HFC-134a Halocarbon in products at disposal: HFC-152a Halocarbon in products at disposal: HFC-32 Halocarbon used for manufacturing: HFC-125 Halocarbon used for manufacturing: HFC-134a Halocarbon used for manufacturing: HFC-32
		Stationary Air-Conditioning: AC integral systems (e.g. window units)	Halocarbon bank: HFC-125 Halocarbon bank: HFC-134a Halocarbon bank: HFC-32 Halocarbon in products at disposal: HFC-125 Halocarbon in products at disposal: HFC-134a Halocarbon in products at disposal: HFC-32

National Communication Sector	IPCC Category	Source	ActivityName
			Halocarbon used for manufacturing: HFC-125 Halocarbon used for manufacturing: HFC-134a Halocarbon used for manufacturing: HFC-32
		Stationary Air-Conditioning: AC roof-top units, large	Halocarbon bank: HFC-125 Halocarbon bank: HFC-134a Halocarbon bank: HFC-227ea Halocarbon bank: HFC-32 Halocarbon in products at disposal: HFC-125 Halocarbon in products at disposal: HFC-134a Halocarbon in products at disposal: HFC-32 Halocarbon used for manufacturing: HFC-125 Halocarbon used for manufacturing: HFC-134a Halocarbon used for manufacturing: HFC-227ea Halocarbon used for manufacturing: HFC-32
		Stationary Air-Conditioning: AC roof-top units, small	Halocarbon bank: HFC-125

National Communication Sector	IPCC Category	Source	ActivityName
			Halocarbon bank: HFC-134a Halocarbon bank: HFC-227ea Halocarbon bank: HFC-32 Halocarbon in products at disposal: HFC-125 Halocarbon in products at disposal: HFC-134a Halocarbon in products at disposal: HFC-32 Halocarbon used for manufacturing: HFC-125 Halocarbon used for manufacturing: HFC-134a Halocarbon used for manufacturing: HFC-227ea Halocarbon used for manufacturing: HFC-32
		Stationary Air-Conditioning: AC split systems, large	Halocarbon bank: HFC-125 Halocarbon bank: HFC-134a Halocarbon bank: HFC-227ea Halocarbon bank: HFC-32 Halocarbon in products at disposal: HFC-125 Halocarbon in products at disposal: HFC-134a

National Communication Sector	IPCC Category	Source	ActivityName
			Halocarbon in products at disposal: HFC-32 Halocarbon used for manufacturing: HFC-125 Halocarbon used for manufacturing: HFC-134a Halocarbon used for manufacturing: HFC-227ea Halocarbon used for manufacturing: HFC-32
		Stationary Air-Conditioning: AC split systems, mid-size	Halocarbon bank: HFC-125 Halocarbon bank: HFC-134a Halocarbon bank: HFC-32 Halocarbon in products at disposal: HFC-125 Halocarbon in products at disposal: HFC-134a Halocarbon in products at disposal: HFC-32 Halocarbon used for manufacturing: HFC-125 Halocarbon used for manufacturing: HFC-134a Halocarbon used for manufacturing: HFC-32
		Stationary Air-Conditioning: AC split systems, small	Halocarbon bank: HFC-125

National Communication Sector	IPCC Category	Source	ActivityName
			Halocarbon bank: HFC-134a Halocarbon bank: HFC-32 Halocarbon in products at disposal: HFC-125 Halocarbon in products at disposal: HFC-134a Halocarbon in products at disposal: HFC-32 Halocarbon used for manufacturing: HFC-125 Halocarbon used for manufacturing: HFC-134a Halocarbon used for manufacturing: HFC-32
		Stationary Air-Conditioning: AC VRF systems, small	Halocarbon bank: HFC-125 Halocarbon bank: HFC-134a Halocarbon bank: HFC-227ea Halocarbon bank: HFC-32 Halocarbon in products at disposal: HFC-125 Halocarbon in products at disposal: HFC-134a Halocarbon in products at disposal: HFC-32 Halocarbon used for manufacturing: HFC-125



National Communication Sector	IPCC Category	Source	ActivityName
			Halocarbon used for manufacturing: HFC-134a Halocarbon used for manufacturing: HFC-227ea Halocarbon used for manufacturing: HFC-32
		Stationary Air-Conditioning: Heat pumps, large	Halocarbon bank: HFC-125 Halocarbon bank: HFC-134a Halocarbon bank: HFC-32 Halocarbon in products at disposal: HFC-125 Halocarbon in products at disposal: HFC-134a Halocarbon in products at disposal: HFC-32 Halocarbon used for manufacturing: HFC-125 Halocarbon used for manufacturing: HFC-134a Halocarbon used for manufacturing: HFC-32
		Stationary Air-Conditioning: Heat pumps, mid-size	Halocarbon bank: HFC-125 Halocarbon bank: HFC-134a Halocarbon bank: HFC-32

National Communication Sector	IPCC Category	Source	ActivityName
			Halocarbon in products at disposal: HFC-125 Halocarbon in products at disposal: HFC-134a Halocarbon in products at disposal: HFC-32 Halocarbon used for manufacturing: HFC-125 Halocarbon used for manufacturing: HFC-134a Halocarbon used for manufacturing: HFC-32
		Stationary Air-Conditioning: Heat pumps, small	Halocarbon bank: HFC-125 Halocarbon bank: HFC-134a Halocarbon bank: HFC-32 Halocarbon in products at disposal: HFC-125 Halocarbon in products at disposal: HFC-134a Halocarbon in products at disposal: HFC-32 Halocarbon used for manufacturing: HFC-125 Halocarbon used for manufacturing: HFC-134a Halocarbon used for manufacturing: HFC-32

National Communication Sector	IPCC Category	Source	ActivityName
		Stationary Air-Conditioning: Heat pumps, very small (domestic)	Halocarbon bank: HFC-125 Halocarbon bank: HFC-134a Halocarbon bank: HFC-32 Halocarbon in products at disposal: HFC-125 Halocarbon in products at disposal: HFC-134a Halocarbon in products at disposal: HFC-32 Halocarbon used for manufacturing: HFC-125 Halocarbon used for manufacturing: HFC-134a Halocarbon used for manufacturing: HFC-32
	2F2a_Closed_foam_blowing_agents	Closed foams	Halocarbon bank: HFC-134a Halocarbon bank: HFC-152a Halocarbon bank: HFC-227ea Halocarbon bank: HFC-245fa Halocarbon bank: HFC-365mfc Halocarbon in products at disposal: HFC-227ea Halocarbon in products at disposal: HFC-245fa

National Communication Sector	IPCC Category	Source	ActivityName
			Halocarbon in products at disposal: HFC-365mfc Halocarbon used for manufacturing: HFC-134a Halocarbon used for manufacturing: HFC-152a Halocarbon used for manufacturing: HFC-227ea Halocarbon used for manufacturing: HFC-245fa Halocarbon used for manufacturing: HFC-365mfc
	2F2b_Open_foam_blowing_agents	One Component Foams	Non-fuel combustion
	2F3_Fire_Protection	Firefighting	Halocarbon bank: C4F10 Halocarbon bank: HFC-227ea Halocarbon in products at disposal: C4F10 Halocarbon in products at disposal: HFC-227ea Halocarbon used for manufacturing: C4F10
	2F5_Solvents	Precision cleaning	Halocarbon use: HFC-43-10mee
	2F6b_Other_Applications:Contained-Refrigerant_containers	Transport and distribution of refrigerants	Halocarbon bank: HFC-125 Halocarbon bank: HFC-134a

National Communication Sector	IPCC Category	Source	ActivityName
			Halocarbon bank: HFC-143a Halocarbon bank: HFC-152a Halocarbon bank: HFC-227ea Halocarbon bank: HFC-32
	2F6b_Other_Applications:Contained-Refrigerant_Processing	F-gas handling	Non-fuel combustion
	2G1_Electrical_equipment	Electrical insulation	Halocarbon bank: SF <sub>6</sub>
	2G2_Military_applications	Airborne Warning And Control Systems	Active Aircraft
	2G2_Particle_accelerators	Particle accelerators	Halocarbon use: SF <sub>6</sub>
	2G2e_Electronics_and_shoes	Electronics and shoes	Non-fuel combustion
	2G2e_Tracer_gas	Tracer gas	Halocarbon use: SF <sub>6</sub>
	2G3a_Medical_applications	N <sub>2</sub> O use as an anaesthetic	Population
	5C2.2b_Non-biogenic:Other	Accidental fires - other buildings	Mass burnt
	non-IPCC	Chemicals (combustion)	Electricity
		Food & drink, tobacco (combustion)	Electricity
		Iron and steel - combustion plant	Electricity
		Miscellaneous industrial/commercial combustion	Electricity
		Non-Ferrous Metal (combustion)	Electricity
		Other industrial combustion	Electricity
		Pulp, Paper and Print (combustion)	Electricity
Exports	Aviation_Bunkers	Aircraft - international cruise	Aviation spirit Aviation turbine fuel
		Aircraft - international take off and landing	Aviation spirit

National Communication Sector	IPCC Category	Source	ActivityName
			Aviation turbine fuel
		Aircraft between UK and Bermuda - Cruise	Aviation turbine fuel
		Aircraft between UK and Bermuda - TOL	Aviation turbine fuel
		Aircraft between UK and CDs - Cruise	Aviation spirit Aviation turbine fuel
		Aircraft between UK and CDs - TOL	Aviation spirit Aviation turbine fuel
		Aircraft between UK and Gibraltar - Cruise	Aviation spirit Aviation turbine fuel
		Aircraft between UK and Gibraltar - TOL	Aviation spirit Aviation turbine fuel
		Aircraft between UK and other OTs (excl Gib. and Bermuda) - Cruise	Aviation turbine fuel
		Aircraft between UK and other OTs (excl Gib. and Bermuda) - TOL	Aviation turbine fuel
		Aircraft engines	Lubricants
	Marine_Bunkers	Shipping - international IPCC definition	Fuel oil Gas oil
		Shipping between UK and Bermuda	Fuel oil
		Shipping between UK and CDs	Fuel oil Gas oil
		Shipping between UK and Gibraltar	Fuel oil
		Shipping between UK and OTs (excl. Gib and Bermuda)	Fuel oil
	non-IPCC	Exports	Aviation turbine fuel

National Communication Sector	IPCC Category	Source	ActivityName
			Burning oil Coke DERV Electricity Fuel oil Lubricants Petrol SSF
Industrial processes	1B2d_Other_energy_industries	Flue Gas Treatment (neutralisation)	Sodium Bicarbonate
	2A1_Cement_Production	Cement - decarbonising	Clinker production
	2A2_Lime_Production	Lime production - decarbonising	Limestone
	2A3_Glass_production	Glass - general	Dolomite Glass-making additives Limestone Soda ash
	2A4a_Other_process_uses_of_carbonates:ceramics	Brick manufacture - all types	Bricks
		Brick manufacture - Fletton	Fletton bricks
		Other ceramics	Clays & shales
	2A4b_Other_uses_of_Soda_Ash	Non Energy Use: chemical feedstock	Soda ash
		Other emissive applications of Soda Ash	Soda ash
	2A4d_Other_process_uses_of_carbonates:_Other	Bread baking	Sodium Bicarbonate
		Other emissive applications of Sodium Bicarbonate	Sodium Bicarbonate
		Unknown applications of Sodium Bicarbonate	Sodium Bicarbonate

National Communication Sector	IPCC Category	Source	ActivityName
	2B1_Ammonia_Production	Ammonia production - feedstock use of gas	Natural gas
	2B10_Chemical_Industry:Other	Chemical industry - general	Process emission
	2B2_Nitric_Acid_Production	Nitric acid production	Acid production
	2B3_Adipic_Acid_Production	Adipic acid production	Adipic acid produced
	2B6_Titanium_dioxide_production	Chemical industry - titanium dioxide	Coke Petroleum coke
	2B7_Soda_Ash_Production	Chemical industry - soda ash	Soda ash produced
	2B8a_Methanol_production	Chemical industry - methanol	Methanol Natural gas
	2B8b_Ethylene_Production	Chemical industry - ethylene	Ethylene
	2B8c_Ethylene_Dichloride_and_Vinyl_Chloride_Monomer	Chemical Industry - ethylene dichloride	Ethylene dichloride
	2B8d_Ethylene_Oxide	Chemical industry - ethylene oxide	Ethylene oxide
	2B8e_Acrylonitrile	Chemical industry - acrylonitrile	Acrylonitrile
	2B8f_Carbon_black_production	Chemical industry - carbon black	Carbon black capacity
	2B9a1_Fluorchemical_production:By-product_emissions	Halocarbons production - by-product	Non-fuel combustion
	2B9b3_Fluorchemical_production:Fugitive_emissions	Halocarbons production - fugitive	Non-fuel combustion
	2C1a_Steel	Basic oxygen furnaces	Dolomite
		Electric arc furnaces	Petroleum coke Steel production (electric arc)
		Ladle arc furnaces	Steel production (oxygen converters)
	2C1b_Pig_iron	Blast furnaces	Coke Fuel oil
	2C1d_Sinter	Sinter production	Coke



National Communication Sector	IPCC Category	Source	ActivityName
			Dolomite Limestone
	2C3_Aluminium_Production	Primary aluminium production - general	Primary aluminium production
		Primary aluminium production - PFC emissions	Primary aluminium production
	2C4_Magnesium_production	Magnesium cover gas	Non-fuel combustion
	2C6_Zinc_Production	Non-ferrous metal processes	Coke
	2G3b_N2O_from_product_uses:_Other	Other food - cream consumption	Process emission
	2G4_Other_product_manufacture_and_use	Chemical Industry – other process sources	Process emission
	non-IPCC	Blast furnaces	Electricity
Land use, land use change and forestry	4_Indirect_N2O_Emissions	LULUCF Indirect N <sub>2</sub> O - Atmospheric Deposition	Non-fuel combustion
		LULUCF Indirect N <sub>2</sub> O - Nitrogen Leaching and Run-off	Non-fuel combustion
	4A_Forest Land_Emissions_from_Drainage	Forest Land - Drainage and rewetting and other management of organic and mineral soils	Non-fuel combustion
	4A1_ Forest Land remaining Forest Land	Forest Land remaining Forest Land - Biomass Burning - Wildfires	Biomass
		Forest Land remaining Forest Land - Carbon stock change	Non-fuel combustion
	4A2_Cropland_converted_to_Forest_Land	Cropland converted to Forest Land - Carbon stock change	Non-fuel combustion
		Cropland converted to Forest Land - Direct N <sub>2</sub> O emissions from N Mineralization/Immobilization	Non-fuel combustion
	4A2_Grassland_converted_to_Forest_Land	Grassland converted to Forest Land - Carbon stock change	Non-fuel combustion

National Communication Sector	IPCC Category	Source	ActivityName
		Grassland converted to Forest Land - Direct N <sub>2</sub> O emissions from N Mineralization/Immobilization	Non-fuel combustion
	4A2_Land_converted_to_Forest_Land_Emissions_from_Fertilisation	Direct N <sub>2</sub> O emission from N fertilisation of forest land	Non-fuel combustion
	4A2_Settlements_converted_to_Forest_Land	Settlements converted to Forest Land - Carbon stock change	Non-fuel combustion
		Settlements converted to Forest Land - Direct N <sub>2</sub> O emissions from N Mineralization/Immobilization	Non-fuel combustion
	4B1_Cropland remaining Cropland	Cropland remaining Cropland - Biomass Burning - Wildfires	Biomass
		Cropland remaining Cropland - Living biomass carbon stock change	Non-fuel combustion
		Cropland remaining Cropland - Soils carbon stock change	Non-fuel combustion
	4B2_Forest_Land_converted_to_Cropland	Forest Land converted to Cropland - Biomass Burning - Controlled Burning	Biomass
		Forest Land converted to Cropland - Carbon stock change	Non-fuel combustion
		Forest Land converted to Cropland - Direct N <sub>2</sub> O emissions from N Mineralization/Immobilization	Non-fuel combustion
	4B2_Grassland_converted_to_Cropland	Grassland converted to Cropland - Carbon stock change	Non-fuel combustion
		Grassland converted to Cropland - Direct N <sub>2</sub> O emissions from N Mineralization/Immobilization	Non-fuel combustion
	4B2_Settlements_converted_to_Cropland	Settlements converted to Cropland - Carbon stock change	Non-fuel combustion
	4C_Grassland_Emissions_from_Drainage	Grassland - Drainage and rewetting and other management of organic and mineral soils	Non-fuel combustion
	4C1_Grassland remaining Grassland	Grassland remaining Grassland - Biomass Burning - Wildfires	Biomass

National Communication Sector	IPCC Category	Source	ActivityName
		Grassland remaining Grassland - Carbon stock change	Non-fuel combustion
		Grassland remaining Grassland - Direct N <sub>2</sub> O emissions from N Mineralization/Immobilization	Non-fuel combustion
	4C2_Cropland_converted_to_Grassland	Cropland converted to Grassland - Carbon stock change	Non-fuel combustion
	4C2_Forest_Land_converted_to_Grassland	Forest Land converted to Grassland - Biomass Burning - Controlled Burning	Biomass
		Forest Land converted to Grassland - Carbon stock change	Non-fuel combustion
		Forest Land converted to Grassland - Direct N <sub>2</sub> O emissions from N Mineralization/Immobilization	Non-fuel combustion
	4C2_Settlements_converted_to_Grassland	Settlements converted to Grassland - Carbon stock change	Non-fuel combustion
	4D_Wetlands_Emissions_from_Drainage	Wetlands - Drainage and rewetting and other management of organic and mineral soils	Non-fuel combustion
	4D1_Wetlands remaining wetlands	Other Wetlands Remaining Other Wetlands - Carbon stock change	Non-fuel combustion
		Peat Extraction Remaining Peat Extraction - Carbon stock change	Non-fuel combustion
	4D2_Forest_Land_converted_to_Wetlands	Forest Land converted to Other Wetlands - Carbon stock change	Non-fuel combustion
	4D2_Grassland_converted_to_Wetlands_Flooded_Land	Grassland converted to flooded land - Carbon stock change	Non-fuel combustion
	4D2_Land converted to Wetlands	Cropland converted to Other Wetlands - Carbon stock change	Non-fuel combustion
		Forest Land converted to Other Wetlands - Biomass Burning - Controlled Burning	Biomass
	4D2_Land_converted_to_Wetlands_Peat_Extraction	Land converted for Peat Extraction - Carbon stock change	Non-fuel combustion

National Communication Sector	IPCC Category	Source	ActivityName
	4E_Settlements_Emissions_from_Drainage	Settlements - Drainage and rewetting and other management of organic and mineral soils	Non-fuel combustion
	4E1_Settlements remaining settlements	Settlements remaining Settlements - Carbon stock change	Non-fuel combustion
		Settlements remaining Settlements - Direct N <sub>2</sub> O emissions from N Mineralization/Immobilization	Non-fuel combustion
	4E2_Cropland_converted_to_Settlements	Cropland converted to Settlements - Carbon stock change	Non-fuel combustion
		Cropland converted to Settlements - Direct N <sub>2</sub> O emissions from N Mineralization/Immobilization	Non-fuel combustion
	4E2_Forest_Land_converted_to_Settlements	Forest Land converted to Settlements - Biomass Burning - Controlled Burning	Biomass
		Forest Land converted to Settlements - Carbon stock change	Non-fuel combustion
		Forest Land converted to Settlements - Direct N <sub>2</sub> O emissions from N Mineralization/Immobilization	Non-fuel combustion
	4E2_Grassland_converted_to_Settlements	Grassland converted to Settlements - Carbon stock change	Non-fuel combustion
		Grassland converted to Settlements - Direct N <sub>2</sub> O emissions from N Mineralization/Immobilization	Non-fuel combustion
	4G_Harvested Wood Products	HWP Produced and Consumed Domestically - Carbon stock change	Non-fuel combustion
		HWP Produced and Exported - Carbon stock change	Non-fuel combustion
Public	1A4ai_Commercial/Institutional	Public sector combustion	Biomass Burning oil Coal Coke

National Communication Sector	IPCC Category	Source	ActivityName
			Fuel oil Gas oil Natural gas
	non-IPCC	Public sector combustion	Electricity
Residential	1A4bi_Residential_stationary	Domestic Boiler	Anthracite Coal Coke LPG Petroleum coke SSF
		Domestic Closed Stove - Basic	Anthracite Coal Coke Petroleum coke SSF Wood - Dry Wood - Seasoned Wood - Wet
		Domestic Closed Stove - EcoDesign	Anthracite Coal Petroleum coke SSF Wood - Dry Wood - Seasoned Wood - Wet

National Communication Sector	IPCC Category	Source	ActivityName
		Domestic Closed Stove - Upgraded	Anthracite Coal Coke Petroleum coke SSF Wood - Dry Wood - Seasoned Wood - Wet
		Domestic Cooking and Other	Burning oil Fuel oil Gas oil Natural gas
		Domestic Fireplace - Standard	Coal Coke Peat Petroleum coke SSF Wood - Dry Wood - Seasoned Wood - Wet
		Domestic Outdoor	Charcoal Coal
		Domestic Space Heater	Burning oil Fuel oil Gas oil

National Communication Sector	IPCC Category	Source	ActivityName
			Natural gas
		Domestic Water Heater	Burning oil Fuel oil Gas oil Natural gas
	1A4bii_Residential:Off-road	House and garden machinery	DERV Petrol
	2D2 Non-energy_products_from_fuels_and_solvent_use:Paraffin_wax_use	Non-aerosol products - household products	Petroleum waxes
	2F4a_Metered_dose_inhalers	Metered dose inhalers	Halocarbon bank: HFC-134a Halocarbon bank: HFC-227ea
	2F4b_Aerosols:Other	Aerosols other than metered dose inhalers	Halocarbon bank: HFC-134a Halocarbon bank: HFC-152a
	2G3b_N2O_from_product_uses:_Other	Recreational use of N <sub>2</sub> O	Process emission
	5B1a_composting_municipal_solid_waste	Composting (at household)	Biological waste
	5C2.1b_Biogenic:Other	Small-scale waste burning	Waste
	5C2.2b_Non-biogenic:Other	Accidental fires - dwellings	Mass burnt
	5C2.2b_Non-biogenic:Other_Accidental fires (vehicles)	Accidental fires - vehicles	Mass burnt
	non-IPCC	Domestic combustion	Electricity
	Transport	1A3a_Domestic_aviation	Aircraft - domestic cruise
Aircraft - domestic take off and landing			Aviation spirit Aviation turbine fuel
1A3bi_Cars		Road transport - cars - cold start	DERV

National Communication Sector	IPCC Category	Source	ActivityName
			Petrol
		Road transport - cars - motorway driving	DERV Petrol
		Road transport - cars - rural driving	DERV Petrol
		Road transport - cars - urban driving	DERV Petrol
	1A3bii_Light_duty_trucks	Road transport - LGVs - cold start	DERV Petrol
		Road transport - LGVs - motorway driving	DERV Petrol
		Road transport - LGVs - rural driving	DERV Petrol
		Road transport - LGVs - urban driving	DERV Petrol
	1A3biii_Heavy_duty_trucks_and_buses	Road transport - buses and coaches - motorway driving	DERV
		Road transport - buses and coaches - rural driving	DERV
		Road transport - buses and coaches - urban driving	DERV
		Road transport - general	Natural gas
		Road transport - HGV articulated - motorway driving	DERV
		Road transport - HGV articulated - rural driving	DERV
		Road transport - HGV articulated - urban driving	DERV



National Communication Sector	IPCC Category	Source	ActivityName
		Road transport - HGV rigid - motorway driving	DERV
		Road transport - HGV rigid - rural driving	DERV
		Road transport - HGV rigid - urban driving	DERV
	1A3biv_Motorcycles	Road transport - mopeds (<50cc 2st) - urban driving	Lubricants Petrol
		Road transport - motorcycle (>50cc 2st) - urban driving	Petrol
		Road transport - motorcycle (>50cc 4st) - motorway driving	Petrol
		Road transport - motorcycle (>50cc 4st) - rural driving	Petrol
		Road transport - motorcycle (>50cc 4st) - urban driving	Petrol
	1A3bv_Other_road_transport	Road transport - all vehicles biofuels use	Biodiesel Bio-MTBE
		Road transport - all vehicles LPG use	LPG
	1A3c_Railways	Rail - coal	Coal
		Railways - freight	Gas oil
		Railways - intercity	Gas oil
		Railways - regional	Gas oil
	1A3d_Domestic_navigation	Inland goods-carrying vessels	Gas oil
		Motorboats / workboats (e.g. canal boats, dredgers, service boats, tourist boats, river boats)	DERV Gas oil Petrol

National Communication Sector	IPCC Category	Source	ActivityName
		Personal watercraft e.g. jet ski	Petrol
		Sailing boats with auxiliary engines	DERV
		Shipping - coastal	Fuel oil Gas oil
	1A3eii_Other_Transportation	Aircraft - support vehicles	Gas oil
	1A4ai_Commercial/Institutional	Railways - stationary combustion	Burning oil Fuel oil Natural gas
	1A4ciii_Fishing	Fishing vessels	Fuel oil Gas oil
	1A5b_Other:Mobile	Aircraft - military	Aviation spirit Aviation turbine fuel
		Shipping - naval	Gas oil
	2D1_Lubricant_Use	Marine engines	Lubricants
		Road vehicle engines	Lubricants
	2D3_Non-energy_products_from_fuels_and_solvent_use:Other	Road transport - urea	Urea consumption
	non-IPCC	Railways - regional	Electricity
		Road vehicle engines	Electricity
Waste Management	5A1a_Managed_Waste_Disposal_sites_anaerobic	Landfill	Non-fuel combustion
	5B1a_composting_municipal_solid_waste	Mechanical Biological Treatment - Composting	Biological waste
		Total composting (non-household)	Biological waste
	5B2a_Anaerobic_digestion_municipal_solid_waste	Anaerobic Digestion (other)	Biological waste
		Mechanical Biological Treatment - Anaerobic Digestion	Biological waste

National Communication Sector	IPCC Category	Source	ActivityName	
	5C1.1b_Biogenic:Sewage_sludge	Incineration - sewage sludge	Sewage sludge combustion	
	5C1.2a_Non-biogenic:municipal_solid_waste	Incineration	MSW	
	5C1.2b_Non-biogenic:Clinical_waste	Incineration - clinical waste	Clinical waste	
	5C1.2b_Non-biogenic:Other_Chemical_waste	Incineration - chemical waste	Chemical waste	
	5D1_Domestic_wastewater_treatment		Sewage sludge decomposition	Non-fuel domestic
			Sewage sludge decomposition in private systems	Non-fuel domestic
	5D2_Industrial_wastewater_treatment		Industrial Waste Water Treatment	Non-fuel combustion

## **A 9.6 DETAILED EMISSIONS ACCORDING TO END USER CATEGORIES**

The end user categories in the data tables in this summary are those used in National Communications. The end user reallocation includes emissions from the UK, this is the coverage used for the UK statistical release, where the end users' data are presented in more detail.

The base year for hydrofluorocarbons, perfluorocarbons, nitrogen trifluoride, and sulphur hexafluoride is 1995. For carbon dioxide, methane and nitrous oxide, the base year is 1990.

**Table A 9.6.1 End user emissions from all National Communication categories, MtCO<sub>2</sub> equivalent**

End user category	Base Year	1990	1995	2000	2005	2010	2015	2020	2021
Agriculture	58.2	58.2	56.7	54.9	53.8	51.1	51.3	47.9	49.2
Business	247.9	247.4	216.8	215.7	208.5	181.6	144.9	104.4	108.2
Exports	10.1	10.1	13.8	13.3	16.6	15.8	11.8	9.3	8.1
Industrial processes	60.7	59.0	49.9	28.6	21.4	13.6	13.3	10.0	10.6
Land use, land use change and forestry	11.1	11.1	8.8	6.3	3.4	1.5	1.0	1.2	1.1
Public	34.6	34.6	31.7	26.5	23.6	19.2	14.6	10.5	11.1
Residential	172.7	172.3	156.8	158.8	162.8	156.3	113.4	91.7	97.3
Transport	148.7	148.7	152.7	154.1	155.9	142.4	138.8	112.3	122.3
Waste Management	72.1	72.1	75.2	67.7	52.8	31.5	21.2	19.0	18.7
Grand Total	816.0	813.4	762.3	725.8	698.7	613.0	510.4	406.3	426.5

**Table A 9.6.2 End user CO<sub>2</sub> emissions from all National Communication categories, MtCO<sub>2</sub> equivalent**

End user category	Base Year	1990	1995	2000	2005	2010	2015	2020	2021
Agriculture	8.7	8.7	8.0	7.6	9.2	9.0	8.4	6.9	7.8
Business	227.8	227.8	201.1	202.8	195.1	166.5	129.1	90.8	95.1
Exports	9.2	9.2	12.8	12.5	15.8	15.1	11.3	8.8	7.7
Industrial processes	21.5	21.5	19.6	18.5	17.1	11.4	12.5	9.5	10.1

End user category	Base Year	1990	1995	2000	2005	2010	2015	2020	2021
Land use, land use change and forestry	3.6	3.6	1.4	-0.9	-3.7	-5.5	-6.0	-5.8	-5.9
Public	32.0	32.0	29.7	25.3	22.8	18.5	14.1	10.2	10.7
Residential	155.5	155.5	143.8	149.0	154.7	149.1	107.6	87.3	93.0
Transport	144.3	144.3	148.3	150.7	153.3	140.5	137.0	110.6	120.7
Waste Management	1.3	1.3	1.0	0.6	0.5	0.3	0.2	0.2	0.3
Grand Total	604.0	604.0	565.7	566.0	564.8	505.0	414.4	318.5	339.5

**Table A 9.6.3 End user CH<sub>4</sub> emissions from all National Communication categories, MtCO<sub>2</sub> equivalent**

End user category	Base Year	1990	1995	2000	2005	2010	2015	2020	2021
Agriculture	32.9	32.9	32.4	31.6	30.1	28.3	28.7	27.8	27.9
Business	17.3	17.3	13.1	8.3	5.4	4.2	3.1	2.2	2.2
Exports	0.8	0.8	0.9	0.7	0.6	0.6	0.5	0.4	0.3
Industrial processes	2.4	2.4	2.0	1.3	0.5	0.4	0.3	0.2	0.2
Land use, land use change and forestry	5.6	5.6	5.5	5.5	5.6	5.6	5.6	5.7	5.7
Public	2.4	2.4	1.9	1.1	0.7	0.6	0.4	0.3	0.3
Residential	16.1	16.1	12.1	7.6	5.5	4.9	3.7	3.0	3.0
Transport	2.9	2.9	2.5	1.7	1.1	0.8	0.7	0.6	0.5
Waste Management	69.9	69.9	73.2	66.0	51.2	29.9	19.5	17.3	16.9
Grand Total	150.3	150.3	143.6	123.8	100.8	75.2	62.5	57.5	57.0

**Table A 9.6.4 End user N<sub>2</sub>O emissions from all National Communication categories, MtCO<sub>2</sub> equivalent**

End user category	Base Year	1990	1995	2000	2005	2010	2015	2020	2021
Agriculture	16.6	16.6	16.2	15.7	14.5	13.9	14.2	13.2	13.6
Business	1.3	1.3	1.2	1.1	1.1	1.1	1.1	1.0	1.0
Exports	0.1	0.1	0.1	0.1	0.1	0.1	0.1	0.1	0.1
Industrial processes	21.2	21.2	12.8	4.8	2.8	1.4	0.2	0.2	0.1
Land use, land use change and forestry	1.9	1.9	1.8	1.7	1.5	1.4	1.3	1.3	1.3
Public	0.1	0.1	0.1	0.1	0.1	0.0	0.0	0.0	0.0
Residential	0.7	0.7	0.5	0.5	0.5	0.4	0.4	0.3	0.3
Transport	1.5	1.5	1.8	1.7	1.4	1.0	1.1	1.0	1.1
Waste Management	0.8	0.8	0.9	1.1	1.1	1.3	1.4	1.5	1.5
Grand Total	44.3	44.3	35.5	26.7	23.1	20.6	19.9	18.6	19.1

# ANNEX 10: Reporting on consistency of the reported data on air pollutants

## A 10.1 NECR AND CLRTAP SUBMISSIONS

The total emissions for all pollutants **agree to within 0.2%**. Discrepancies at a category level relate primarily to differences in allocation between the energy and IPPU sectors (e.g. for lubricants), and between the waste and 'Other' sectors (e.g. accidental fires, bonfires and non-agriculture livestock).

Differences in the totals relate only to differences in reporting for aviation (which is a subset of 1A3, and the total difference for 1A3 includes the impact of differing allocations for lubricants). For aviation, all Take Off and Landing (TOL) emissions (domestic and international) are included for NECR and CLRTAP, and all domestic emissions (TOL and cruise) are included for GHG reporting.

For the full analysis, please see the '*Annex\_Air\_Pollutant\_Consistency\_2023\_Submission.xlsx*' supplemental Excel file.